

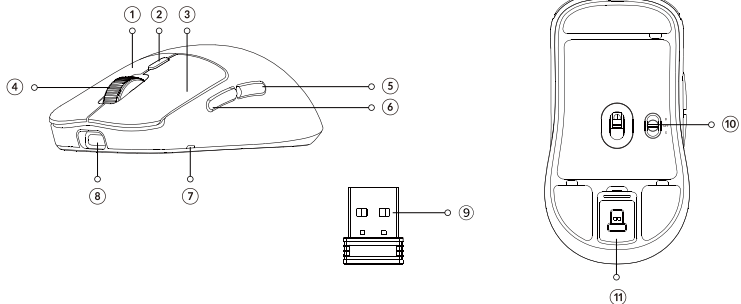

Lemokey

G2 WIRELESS MOUSE USER MANUAL



- ① Right button
- ② DPI button
- ③ Left button
- ④ Middle wheel button
- ⑤ Backward button
- ⑥ Forward button
- ⑦ Mouse indicator
- ⑧ Charging port
- ⑨ 2.4GHz Type - A receiver
- ⑩ Modes toggle
- ⑪ Receiver compartment

3 Modes of connection

Wired Mode:

1. When the mode switch is in "OFF" position, the mouse won't respond if the cable is not connected.
 2. Connect the cable to the TYPE-C port of the mouse and the USB port on the device. The mouse is ready to use while the indicator lights up.
- * When connected by cable, the mode will default to wired mode even if the toggle is in Bluetooth mode or 2.4GHz mode.

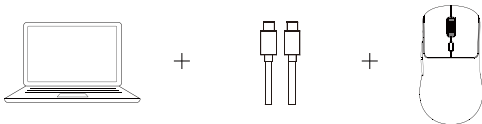

2.4GHz Mode:

1. Switch to "G" mode (2.4GHz mode), and the mouse will automatically turn on 2.4GHz pairing. The mouse indicator will slowly flash green.
2. Find the 2.4GHz receiver and connect it to the device's USB. Once successfully connected, the mouse indicator will turn green and stay on for 3 seconds before dimming off. The mouse is now ready for use.

3. In 2.4GHz pairing mode, the mouse indicator will slowly blink green for 3 minutes. If the mouse is not connected within 3 minutes, the indicator will turn off. If you need to reconnect, hold both the "Left button + Middle Wheel + Right button" for 4 seconds to re-enter pairing mode.
- If you need to repair the connection in 2.4GHz mode, please unplug the 2.4GHz receiver first. Then, hold both the "Left button + Middle Wheel + Right button" for 4 seconds, wait for the green light indicator to start flashing, and plug the 2.4GHz receiver back in to complete the pairing process.

Note: It is recommended that when pairing the G2 in 2.4GHz mode, the mouse should be within 20cm of the receiver.

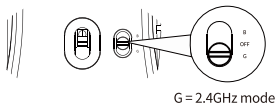

simultaneously hold for 4 seconds
(to enter the forced pairing mode)

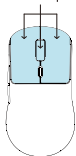

Note: For the best wireless experience, we recommend using the cable and putting the 2.4GHz receiver somewhere on your desk close to your mouse for a lower rate of latency and fewer signal interferences.

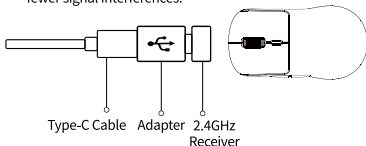

Bluetooth mode

1. Switch to "B" Mode (Bluetooth), and the mouse will automatically turn on Bluetooth pairing mode. The mouse indicator will slowly flash blue.
2. Open the Bluetooth settings, search for a device named "Lemokey G2", then click "connect" to complete pairing.
3. When in Bluetooth pairing mode, the mouse indicator will slowly blink in blue for 3 minutes. If it's not connected within 3 minutes, the mouse indicator will turn off. If you need to reconnect, you need to hold the "Left button+Middle Wheel+Right button" for 4 seconds to re-enter pairing mode. The indicator will slowly blink blue.
4. If the G2 is in Bluetooth mode and needs to pair with a new device, hold both the "Left button+Middle Wheel+Right button" for 4 seconds and wait for the blue light to flash on. At this point, Bluetooth has re-entered pairing mode, and you can connect the new device to the G2.

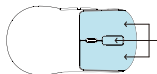

simultaneously hold for 4 seconds
(to re-enter pairing mode)

Status indicator

2.4GHz Mode	*The mouse indicator slowly blinks green - Ready to be paired. *The mouse indicator quickly blinks green - Pairing with the previous device.
Bluetooth Mode	*The mouse indicator slowly blinks blue - Ready to be paired. *The mouse indicator quickly blinks blue - Pairing with the previous device.
Low Power	The mouse indicator will slowly blink red.

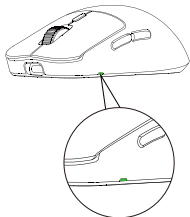

DPI indicator

White light	400 DPI	Yellow light	3200 DPI
Green light	800 DPI	Red light	5000 DPI
Blue light	1600 DPI (default)		

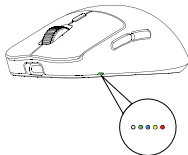

Report Rate

Report rate	Report rate / Hz	Available modes
White	125	2.4G / BT / Wired
Green	500	2.4G / Wired
Blue	1000	2.4G / Wired(default)
Yellow	2000	2.4G / Wired
Red	4000	2.4G / Wired
Purple	8000	2.4G / Wired



*Please adjust the report rate in the driver software.

Driver Software

The Lemokey G2 mouse driver can be selected on launcher.lemokey.com. If the driver software can't connect to the mouse, please contact us for technical support.

Auto-Sleep mode

Auto-Sleep mode will not be activated when in wired mode. When in Bluetooth mode or 2.4GHz mode, the mouse will go to Auto-Sleep mode after 10 minutes of sitting idle to save the battery. Move or click the mouse to wake it up.

How to factory reset

Hold down both the "DPI" button and "Middle Wheel" button for 4 seconds, and all the LED lights on the mouse will blink. It will blink three times to indicate that the factory reset is successful.

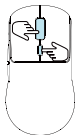

simultaneously hold for 4 seconds
(starts factory reset)

Charging indicator explanation

Fully Charged	The mouse indicator will stay GREEN.
Low Power	The mouse indicator will slowly blink RED.

* The mouse is compatible with all USB ports. For the best signal and charging speed, connecting to the USB3.0 port is recommended when charging or in use.

* If the mouse is connected by the USB Type - C cable when charging but not paired with any devices:

- The mouse indicator will stay RED when charging.
- The mouse indicator will stay GREEN when fully charged.

Note: The product supports up to 5V charging voltage and 150 mA charging current. We are not responsible for any problems caused by improper recharging.

What's in the box

Mouse x 1

Extension adapter x 1

User manual x 1

Type - C cable x 1

Type - A receiver x 1

Type - A to Type - C adapter x 1

Mouse specification

Size: 118*62.6*38.2mm

Weight: 52 ± 3g

Report Rate(polling rate): 125(White) - 500(Green) - 1000(Blue)

- 2000(Yellow) - 4000(Red) - 8000(Purple)

Sensor: PixArt 3950

Resolution: 100 - 30000DPI

Mouse micro switches: Huano Micro Switch (80 million clicks life time)

2.4GHz / Bluetooth connection range: Approx 10m of open space

Battery capacity: 300mAh

Usage duration: 60 Hours (Under 1000Hz)

35 Hours (1000-4000Hz)

20 Hours (4000-8000Hz)

Recharge time: 2.5 Hours

Charging port: Type - C

Connection mode: 2.4GHz - Bluetooth - Wired

Device name: Lemokey G2



Find us at:

<https://www.lemokey.com>

Support@lemokey.com

 @lemokey

 @lemokey.keyboard

 @lemokey_com

Designed by Lemokey

Made in China



G2 无线鼠标使用说明

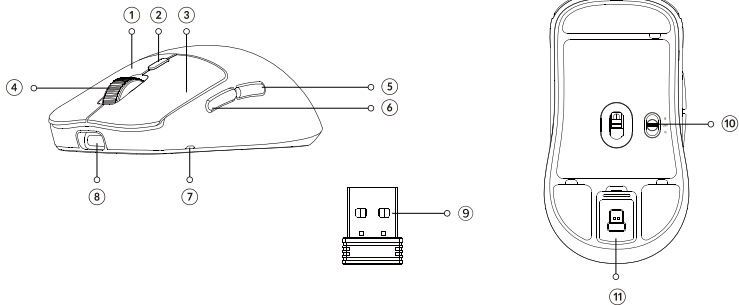

① 右键

② DPI按钮

③ 左键

④ 中键滚轮

⑤ 后退键

⑥ 前进键

⑦ 鼠标指示灯

⑧ 充电口

⑨ 2.4G Type-A接收器

⑩ 模式拨片

⑪ 接收器存储仓

三模连接方式

有线模式：

- 1、在OFF档位下，无连接USB线材，鼠标无任何反应。
 - 2、将数据线连接至鼠标Type-C接口以及设备USB接口，鼠标指示灯亮起即可使用。
- * 即使模式开关是在蓝牙或者2.4G的档位下，当数据线连接上设备后，鼠标将默认为有线模式使用。

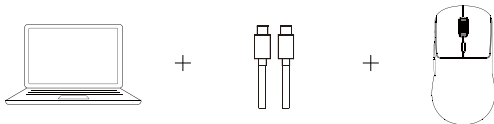

2.4G模式：

- 1、将鼠标底部开关拨动到“G”模式档位（2.4G模式）。鼠标自动进入2.4G配对模式，鼠标指示灯绿灯慢闪。
- 2、将鼠标2.4G接收器连接至设备端的USB接口，连接成功后，鼠标指示灯常亮3秒后熄灭，鼠标正常使用。

3、在2.4G模式下，鼠标指示灯绿灯将会慢闪并持续三分钟，如果没有在三分钟内进行连接使用，鼠标指示灯熄灭。

如需重新配对，可以同时长按鼠标左键 + 中键 + 右键4秒，重新进入匹配状态。

* 如果需要重新进行2.4G模式的连接，首先请拔出2.4G接收器。然后同时长按鼠标左键 + 中键 + 右键4秒，等待鼠标指示灯绿灯开始闪烁，之后重新插入2.4G接收器完成配对操作。

注意：进行2.4GHz模式强制配对时，建议鼠标与接收器的距离不超过20cm。

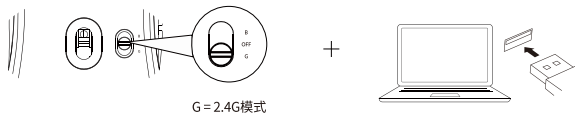

同时保持4秒
(进入强制配对模式)

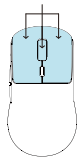

注意：为了获得最佳的无线体验，我们建议将2.4G接收器插入线材+赠送的转接头，放置在书桌上靠近你的鼠标，以降低延迟率和更少的干扰信号。

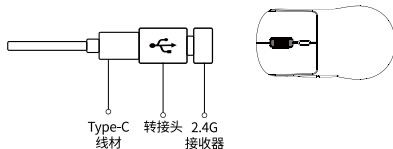

蓝牙模式

- 1、将鼠标底部开关拨动到“B”模式档位(蓝牙模式)。鼠标自动进入蓝牙配对模式,鼠标指示灯蓝灯慢闪。
- 2、此时打开设备蓝牙设置,搜索设备:Lemokey G2,点击连接即可使用。
- 3、拨动到蓝牙模式下,鼠标指示灯蓝灯将会慢闪并持续三分钟,如果没有在三分钟内进行连接使用,鼠标指示灯熄灭。
如需重新配对,可以同时长按鼠标左键+中键+右键4秒,即可重新进入配对模式,鼠标指示灯蓝灯持续慢闪。
- 4、如果G2鼠标在蓝牙模式下需要与其他新设备进行连接,可以同时长按鼠标左键+中键+右键4秒,鼠标指示灯将会蓝灯慢闪,即可重新进入鼠标蓝牙配对状态。此时您可以让新设备与G2进行连接。

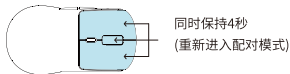

功能指示灯说明

2.4G模式	鼠标指示灯 (绿灯) 慢闪-配对 鼠标指示灯 (绿灯) 快闪-回连
蓝牙模式	鼠标指示灯 (蓝灯) 慢闪-配对 鼠标指示灯 (蓝灯) 快闪-回连
低电状态	鼠标指示灯 (红灯) 慢闪

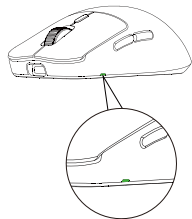

DPI 指示灯

白灯	400 DPI	黄灯	3200 DPI
绿灯	800 DPI	红灯	5000 DPI
蓝灯	1600 DPI(默认)		

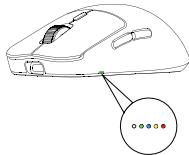

回报率指示

回报率指示	回报率 / Hz	模式
白色	125	2.4G / BT / 有线
绿色	500	2.4G / 有线
蓝色	1000	2.4G / 有线(默认)
黄色	2000	2.4G / 有线
红色	4000	2.4G / 有线
紫色	8000	2.4G / 有线



*请在驱动软件中调节回报率。

驱动程序

可以在launcher.lemokey.com选择Lemokey G2鼠标驱动,如驱动软件无法连接鼠标,请联系我们提供技术支持。

休眠模式

有线模式下无休眠状态,蓝牙/2.4G模式(游戏模式/办公模式)下,鼠标无操作10分钟后自动进入休眠状态,移动或者点击操作即可唤醒鼠标。

恢复出厂模式

同时长按DPI按钮与中键按钮4秒,鼠标整体LED灯光闪烁,闪烁三次代表恢复出厂设置成功



同时保持4秒
(开始恢复出厂设置)

充电指示灯说明

电量充满时	鼠标指示灯绿灯常亮
低电量时	鼠标指示灯红灯慢闪

*鼠标与所有USB端口兼容,如需获得最佳信号以及充电速度,建议连接USB3.0端口进行充电和使用

*鼠标如果无连接状态下连接USB Type-C线材充电,

充电中:鼠标指示灯红灯常亮

充满时:鼠标指示灯绿灯常亮

注意:本产品最高支持5V充电电压,150 mA充电电流。因不当充电而导致的问题,概不负责。

内容清单

鼠标 x 1

接收器延长器 x 1

说明书 x 1

Type - C 线材 x 1

Type - A 接收器 x 1

Type - A to Type - C 转接头 x 1

鼠标规格

尺寸: 118*62.6*38.2mm

重量: 52±3g

回报率: 125(白色) - 500(绿色) - 1000(蓝色) - 2000(黄色)
- 4000(红色) - 8000(紫色)

传感器: PixArt 3950

分辨率: 100-30000DPI

微动开关: 环诺(8000万次)

2.4G / 蓝牙模式工作距离: 开放环境下约10米

电池容量: 300mAh

续航: 60 小时(1000Hz以下)

35 小时(1000-4000Hz)

20 小时(4000-8000Hz)

充电时间: 2.5小时

充电端口: Type-C

使用模式: 2.4G-蓝牙-有线

设备名称: Lemokey G2



Find us at:

<https://www.lemokey.com>

Support@lemokey.com

 @lemokey

 @lemokey.keyboard

 @lemokey_com

Designed by Lemokey

Made in China

中国区总代：渴创技术（深圳）有限公司

执行标准：GB 4943.1-2022

售后热线：400-0766268

地 址：深圳市龙岗区坂田街道大发埔社区
大发路24号文坑工业区2栋201