



MTNBIKE
APPAREL
CONCEPT

-

COMING 2023

LIVE TRAIL LIFE



100 YEARS +
 OF AUTHENTIC SWISS HERITAGE.
 PROUDLY CREATED IN SWITZERLAND.



***EIN HISTORISCHES ERBE. KREIERT
 UND GESCHRIEBEN IN UND AUS DER
 SCHWEIZ.***

TWO WHEEL PASSION

It all began in 1906, more than 100 years ago, where in the Swiss canton of Lucerne, a family-owned repair shop for bicycles and motorcycles was opened. This repair shop would later evolve into today's diversified Hostettler Group (AG) in 1957, laying the foundation for all our favorite 2-wheeled activities.

iXS, launched in 1979, allowed the company to step in and step up against market competition, rich with renowned contenders and suppliers within the business of motorcycle equipment and apparel. Some 20 years later, precisely in 2001, iXS Sports Division was launched, signaling a new era of mountain bike apparel and protective gear development, entirely built on a century-long passion for mountain bike sports, the outdoors, and a strong passion for racing.

... and with another 20 years "under our belts", we have an exciting program to present to you in the following pages. Enjoy surfing our catalogue & stay stoked.

LEIDENSCHAFT FÜR ZWEIRÄDER

Was im Jahre 1906 im luzernischen Wolhusen als Familienbetrieb mit einer einfachen Fahrrad- und Motorradwerkstätte begann, hat sich bis heute zum vielseitigen Unternehmen mit insgesamt acht innovativen Tochterfirmen entwickelt. Mit der Gründung der hostettler ag wurde 1957 der Grundstein zur heutigen Geschäftsform gelegt.

Mit der Gründung von iXS im Jahr 1979, tritt die Firma gegen die grossen Herausforderer im Reigen der Motorrad-Bekleidungsanbieter an. Etwas mehr als zwanzig Jahre später, genau gesagt in 2001, wurde die Marke um die iXS Sports Division ergänzt. Die Entwicklung funktioneller Mountainbike Bekleidung und Schutzausrüstung basiert auf jahrzehntelanger Leidenschaft für den Mountainbike Sport, das draussen sein und die grosse Leidenschaft für den Rennsport.

... und weitere zwanzig und etwas mehr Jahre später haben wir eine grandiose Auswahl an fantastischen MTB Produkten für dich bereit. Wir hoffen du findest dein neues Lieblingsprodukt beim Blättern durch die Seiten...



155 taupe-raisin

WOMEN'S FLOW MOUNTAIN TECH TEE

Medium weight X-stretch jersey fabric | Made from recycled PET fiber | Natural touch and feel | Breathable, fast dry, wicking | Anti-microbial, anti-odor | Microfiber lens wipe

Mittelschweres X-Stretch Jersey Material | Gefertigt aus recyceltem PET | Natürlicher & weicher Griff | Atmungsaktiv, schnell trocknend, feuchtigkeitstransportierend | Anti-mikrobiell, anti-odor | Mikrofaser Brillenputztuch

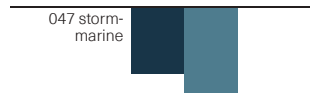

MATERIAL 95% Polyester, 5% Elastane
ITEM-NO. 473-510-2651 & 473-510-2651K (KIDS)

**AVAILABLE
IN KIDS SIZING**

EU	KS	KM	KL	34	36	38	40	42	44
	128	140	152	XS	S	M	L	XL	XXL
*US	KS	KM	KL	XS	S	M	L	XL	XXL
*ASIA	KS	KM	KL	S	M	L	XL	XXL	3XL



172 olive

WOMEN'S FLOW CONTOUR TECH TEE

Medium weight X-stretch jersey fabric | Made from recycled PET fiber | Natural touch and feel | Breathable, fast dry, wicking | Anti-microbial, anti-odor | Microfiber lens wipe

Mittelschweres X-Stretch Jersey Material | Gefertigt aus recyceltem PET | Natürlicher & weicher Griff | Atmungsaktiv, schnell trocknend, feuchtigkeitstransportierend | Anti-mikrobiell, anti-odor | Mikrofaser Brillenputztuch



**AVAILABLE
IN KIDS SIZING**

MATERIAL 95% Polyester, 5% Elastane
ITEM-NO. 473-510-2650 & 473-510-2650K (KIDS)

EU	KS	KM	KL	34	36	38	40	42	44
	128	140	152	XS	S	M	L	XL	XXL
*US	KS	KM	KL	XS	S	M	L	XL	XXL
*ASIA	KS	KM	KL	S	M	L	XL	XXL	3XL



WOMEN'S FLOW XTG LONG SLEEVE HENLEY

NEW Superlight X-stretch jersey & mesh fabric | Made from recycled PET fiber | Breathable, fast drying, moisture wicking | Anti-microbial, anti-odor | Areated mesh back | Super light front snap button closure | Microfiber lens-wipe | Elastic cuff | Size down for a tighter performance fit!

NEUES Superleichtes X-Stretch Jersey & Mesh Material | Gefertigt aus recyceltem PET | Atmungsaktiv, schnell trocknend, feuchtigkeitstransportierend | Anti-mikrobiell, anti-odor | Mesh belüfteter Rücken | Super leichte Druck Knopfleiste | Mikrofaser-Brillenputztuch | Elastischer Ärmelbund | Wähle eine Grösse kleiner für einen Performance-Fit

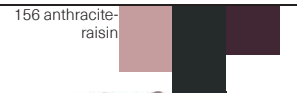

material Body: 95% Polyester, 5% Elastane
Back: 92% Polyester, 8% Elastane
ITEM-NO. 473-510-3670

EU	34 XS	36 S	38 M	40 L	42 XL	44 XXL
*US	XS	S	M	L	XL	XXL
*ASIA	S	M	L	XL	XXL	3XL



WOMEN'S FLOW XTG SHIRT

Light X-stretch ripstop fabric | Made from recycled PET fiber | DWR treated (water repellent) | 3/4 length sleeve fixation | Backvent for improved air circulation | Zippered back pocket | Full silent front snap button closure | Size down for a tighter performance fit!

Leichtes X-Stretch Ripstop Material | Gefertigt aus recyceltem PET | DWR wasserabweisende Imprägnierung | 3/4 Ärmellängen fixierung | Belüftungsöffnung am Rücken | RV Rückentasche | Druchgehende lautlose Druck-Knopfleiste | Wähle eine Grösse kleiner für einen Performance-Fit*



MATERIAL 92% Polyester, 8% Elastane
ITEM-NO. 473-510-3675

EU	34 XS	36 S	38 M	40 L	42 XL	44 XXL
*US	XS	S	M	L	XL	XXL
*ASIA	S	M	L	XL	XXL	3XL



047 marine



WOMEN'S FLOW XTG HIP-HUGGER SHORTS

Superlight boardshorts fabric | Made from recycled PET fiber | 2-way stretch | High-rise comfort waistband | Breathable, fast drying, moisture wicking | Zippered handpocket

Superleichtes Boardshorts Material | Gefertigt aus recyceltem PET | Zwei-weg stretch | High-rise Komfort Bund | Atmungsaktiv, schnell trocknend, feuchtigkeitstransportierend | RV Hosentasche



156 raisin



003 black



MATERIAL 86% Polyester, 14% Elastane
ITEM-NO. 473-510-3680

EU	34 XS	36 S	38 M	40 L	42 XL	44 XXL
*US	XS	S	M	L	XL	XXL
*ASIA	S	M	L	XL	XXL	3XL



155 taupe-raisin



WOMEN'S CARVE X 3/4 HENLEY

Light X-stretch jersey fabric | Made from recycled PET fiber | Anti-microbial, anti-odor | 3/4 sleeves optimized for elbowguard use | Super light front snap button closure | Breathable, fast drying, moisture wicking | Microfiber lens-wipe

Leichtes X-Stretch Jersey Material | Gefertigt aus recyceltem PET | Anti-mikrobiell, anti-odor | 3/4 Ärmel optimiert für Ellbogenschoner | Super leichte Druck-Knopfleiste | Atmungsaktiv, schnell trocknend, feuchtigkeitstransportierend | Mikrofaser Brillenputztuch



003 graphite-black



047 storm-marine



MATERIAL 95% Polyester, 5% Elastane
ITEM-NO. 473-510-2660

EU	34 XS	36 S	38 M	40 L	42 XL	44 XXL
*US	XS	S	M	L	XL	XXL
*ASIA	S	M	L	XL	XXL	3XL



WOMEN'S CARVE HIP-HUGGER SHORTS

Durable X-stretch fabric | Made from recycled PET fiber | Multidirectional stretch (4-way) | High-rise comfort waistband | Breathable, fast drying, moisture wicking | Zippered hand & cargo pockets

Robustes X-stretch Material | Gefertigt aus recyceltem PET | Multidirektionaler stretch (4-way) | High-rise Komfort Bund | Atmungsaktiv, schnell trocknend, feuchtigkeitstransportierend | RV Hosen- & Cargo-Taschen



003 black



047 marine

MATERIAL 88% Polyester, 12% Elastane
ITEM-NO. 473-510-1680

EU	34 XS	36 S	38 M	40 L	42 XL	44 XXL
*US	XS	S	M	L	XL	XXL
*ASIA	S	M	L	XL	XXL	3XL



WOMEN'S CARVE EVO SHORTS

Durable X-stretch fabric | Made from recycled PET fiber | Multidirectional stretch (4-way) | Internal waist adjuster | Silicone anti slip print | Zippered hand & cargo pockets

Robustes X-stretch Material | Gefertigt aus recyceltem PET | Multidirektionaler stretch (4-way) | Innenliegende Bundweitenverstellung | Silikon Anti-Rutsch Print | RV Hosen- & Cargo-Taschen



MATERIAL 88% Polyester, 12% Elastane
ITEM-NO. 473-510-0680

EU	34 XS	36 S	38 M	40 L	42 XL	44 XXL
*US	XS	S	M	L	XL	XXL
*ASIA	S	M	L	XL	XXL	3XL



005 acacia-black



WOMEN'S CARVE DIGGER SHIRT

Durable X-stretch flannel fabric | *Durable X-stretch denim fabric| Made from recycled PET fiber | *Made from organic cotton | yarn dyed | *Stone washed | DWR treated (water repellent) | Full silent front snap button closure | 2 chest pockets

Robustes X-stretch Flannel Material | *Robustes X-stretch Denim Material | Gefertigt aus recyceltem PET | *Gefertigt aus Bio Baumwolle | Zwirn gefärbt | *Stone washed | DWR wasserabweisende Imprägnierung | Druchgehende lautlose Druck-Knopfleiste | Zwei Brusttaschen



156 raisin-black



059 Washed blue (organic)



MATERIAL 64% Polyester, 33% Viscose, 5% Elastane
*96% Cotton, 4% Elastane
ITEM-NO. 473-510-1671 (flannel)
*473-510-1675 (organic denim)

EU	34 XS	36 S	38 M	40 L	42 XL	44 XXL
*US	XS	S	M	L	XL	XXL
*ASIA	S	M	L	XL	XXL	3XL



155 taupe



WOMEN'S CARVE DUNGAREES

Durable X-stretch fabric | Made from recycled PET fiber | DWR treated (water repellent) | Multidirectional stretch (4-way) | 2 zippered handpockets & chest pocket | Silent snap button waist closure | Adjustable elastic shoulderstaps & beltloops

Robustes X-stretch Material | Gefertigt aus recyceltem PET | DWR wasserabweisende Imprägnierung | Multidirektionaler stretch (4-way) | 2 RV Hosen- & Brusttasche | Lautloser Druckknopfverschluss an der Taille | Einstellbare elastische Träger & Gurtschlaufen



971 anthracite



MATERIAL 92% Polyester, 8% Elastane
ITEM-NO. 473-510-3695

EU	34 XS	36 S	38 M	40 L	42 XL	44 XXL
*US	XS	S	M	L	XL	XXL
*ASIA	S	M	L	XL	XXL	3XL



133 acacia-charcoal



FLOW X JERSEY

Light X-stretch jersey fabric | Made from recycled PET fiber | Anti-microbial, anti-odor | Open chest pocket | Breathable, fast drying, moisture wicking | Microfiber lens-wipe

Leichtes X-Stretch Jersey Material | Gefertigt aus recyceltem PET | Anti-mikrobiell, anti-odor | Offene Brusttasche | Atmungsaktiv, schnell trocknend, feuchtigkeitstransportierend | Mikrofaser Brillenputztuch



047 storm-marine



003 black



171 olive-dark olive



MATERIAL 95% Polyester, 5% Elastane
ITEM-NO. 473-510-3350 & 473-510-3350K

EU	KS 128	KM 140	KL 152	XS	S	M	L	XL	XXL
*US	KS	KM	KL	XXS	XS	S	M	L	XL
*ASIA	KS	KM	KL	S	M	L	XL	XXL	3XL

**AVAILABLE
IN KIDS SIZING**



155 taupe



FLOW FADE TECH TEE

Medium weight X-stretch jersey fabric | Made from recycled PET fiber | Natural touch and feel | Breathable, fast dry, wicking | Anti-microbial, anti-odor | Microfiber lens wipe

Mittelschweres X-Stretch Jersey Material | Gefertigt aus recyceltem PET | Natürlicher & weicher Griff | Atmungsaktiv, schnell trocknend, feuchtigkeitstransportierend | Anti-mikrobiell, anti-odor | Mikrofaser Brillenputztuch



047 marine



903 coffee



MATERIAL 95% Polyester, 5% Elastane
ITEM-NO. 473-510-3351 & 473-510-3351K

EU	KS 128	KM 140	KL 152	XS	S	M	L	XL	XXL
*US	KS	KM	KL	XXS	XS	S	M	L	XL
*ASIA	KS	KM	KL	S	M	L	XL	XXL	3XL

**AVAILABLE
IN KIDS SIZING**



FLOW CENSORED TECH TEE

Medium weight X-stretch jersey fabric | Made from recycled PET fiber | Natural touch and feel | Breathable, fast dry, wicking | Anti-microbial, anti-odor | Microfiber lens wipe

Mittelschweres X-Stretch Jersey Material | Gefertigt aus recyceltem PET | Natürlicher & weicher Griff | Atmungsaktiv, schnell trocknend, feuchtigkeitstransportierend | Anti-mikrobiell, anti-odor | Mikrofaser Brillenputztuch



FLOW GETOUTANDPLAY TECH TEE

Medium weight X-stretch jersey fabric | Made from recycled PET fiber | Natural touch and feel | Breathable, fast dry, wicking | Anti-microbial, anti-odor | Microfiber lens wipe

Mittelschweres X-Stretch Jersey Material | Gefertigt aus recyceltem PET | Natürlicher & weicher Griff | Atmungsaktiv, schnell trocknend, feuchtigkeitstransportierend | Anti-mikrobiell, anti-odor | Mikrofaser Brillenputztuch

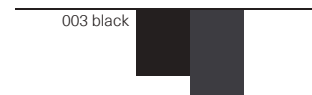

MATERIAL 95% Polyester, 5% Elastane
ITEM-NO. 473-510-3352 & 473-510-3352K

EU	KS 128	KM 140	KL 152	XS	S	M	L	XL	XXL
*US	KS	KM	KL	XXS	XS	S	M	L	XL
*ASIA	KS	KM	KL	S	M	L	XL	XXL	3XL

**AVAILABLE
IN KIDS SIZING**

MATERIAL 95% Polyester, 5% Elastane
ITEM-NO. 473-510-1351 & 473-510-1351K

EU	KS 128	KM 140	KL 152	XS	S	M	L	XL	XXL
*US	KS	KM	KL	XXS	XS	S	M	L	XL
*ASIA	KS	KM	KL	S	M	L	XL	XXL	3XL

**AVAILABLE
IN KIDS SIZING**



171 olive-dark olive



FLOW X LONG SLEEVE JERSEY

Light X-stretch jersey fabric | Made from recycled PET fiber | Anti-microbial, anti-odor | Elastic cuff | Breathable, fast drying, moisture wicking | Microfiber lens-wipe

Leichtes X-Stretch Jersey Material | Gefertigt aus recyceltem PET | Anti-mikrobiell, anti-odor | Elastischer Ärmelbund | Atmungsaktiv, schnell trocknend, feuchtigkeitstransportierend | Mikrofaser Brillenputztuch



MATERIAL 95% Polyester, 5% Elastane
ITEM-NO. 473-510-1370 & 473-510-1370K

**AVAILABLE
IN KIDS SIZING**

EU	KS 128	KM 140	KL 152	XS	S	M	L	XL	XXL
*US	KS	KM	KL	XXS	XS	S	M	L	XL
*ASIA	KS	KM	KL	S	M	L	XL	XXL	3XL



156 graphite-raisin



FLOW XTG LONG SLEEVE HENLEY

NEW Superlight X-stretch jersey & mesh fabric | Made from recycled PET fiber | Breathable, fast drying, moisture wicking | Anti-microbial, anti-odor | Areated mesh back | Super light front snap button closure | Microfiber lens-wipe | Elastic cuff | Size down for a tighter performance fit!

NEUES Superleichtes X-Stretch Jersey & Mesh Material | Gefertigt aus recyceltem PET | Atmungsaktiv, schnell trocknend, feuchtigkeitstransportierend | Anti-mikrobiell, anti-odor | Mesh belüfteter Rücken | Superleichte Druck-Knopfleiste | Mikrofaser-Brillenputztuch | Elastischer Ärmelbund | Wähle eine Größe kleiner für einen Performance-Fit



MATERIAL Body: 95% Polyester, 5% Elastane
Back: 92% Polyester, 8% Elastane
ITEM-NO. 473-510-3370

EU	XS	S	M	L	XL	XXL
*US	XXS	XS	S	M	L	XL
*ASIA	S	M	L	XL	XXL	3XL



003 black



FLOW VEST

Light X-stretch ripstop fabric with laminated insulation | Made from recycled PET fiber | DWR treated (water repellent) | Full chest zipper | Reflective prints (front & back) | Zippered chest & back pocket | Size down for a tighter performance fit!

Leichtes X-Stretch Ripstop Material mit laminiertes Isolierung | Gefertigt aus recyceltem PET | DWR wasserabweisende Imprägnierung | Durchgehender Brust RV | Reflektierende Drucke (vorne & hinten) | RV Brust & Rückenstasche | Wähle eine Größe kleiner für einen Performance-Fit



MATERIAL 96% Polyester, 4% Elastane
ITEM-NO. 473-510-3320

EU	XS	S	M	L	XL	XXL
*US	XXS	XS	S	M	L	XL
*ASIA	S	M	L	XL	XXL	3XL



155 taupe

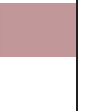

FLOW XTG SHIRT

Light X-stretch ripstop fabric | Made from recycled PET fiber | DWR treated (water repellent) | 3/4 length sleeve fixation | Backvent for improved air circulation | Zippered back pocket | Full silent front snap button closure | Size down for a tighter performance fit!

Leichtes X-Stretch Ripstop Material | Gefertigt aus recyceltem PET | DWR wasserabweisende Imprägnierung | 3/4 Ärmellängen Fixierung | Belüftungsöffnung am Rücken | RV Rückentasche | Durchgehende lautlose Druck-Knopfleiste | Wähle eine Größe kleiner für einen Performance-Fit



MATERIAL 92% Polyester, 8% Elastane
ITEM-NO. 473-510-3375

EU	XS	S	M	L	XL	XXL
*US	XXS	XS	S	M	L	XL
*ASIA	S	M	L	XL	XXL	3XL

003 black





156 raisin



FLOW XTG SHORTS

Superlight boardshorts fabric | Made from recycled PET fiber | 2-way stretch | Elastic loop board-shorts closure | Breathable, fast drying, moisture wicking | Zippered hand & cargo pockets

Superleichtes Boardshorts Material | Gefertigt aus recyceltem PET | Zwei-weg stretch | Elastic Loop Board-Shorts Verschluss | Atmungsaktiv, schnell trocknend, feuchtigkeitstransportierend | RV Hosen- & Cargo-Taschen



003 black



**AVAILABLE
IN KIDS SIZING**

MATERIAL 86% Polyester, 14% Elastane
ITEM-NO. 473-510-1380 & 473-510-1380K

EU	KS	KM	KL	XS	S	M	L	XL	XXL
*US	KS	KM	KL	XXS	XS	S	M	L	XL
*ASIA	KS	KM	KL	S	M	L	XL	XXL	3XL



003 black



FLOW XTG PANTS

Superlight boardshorts fabric | Made from recycled PET fiber | 2-way stretch | Elastic loop board-shorts closure | Back knee venting | Zippered hand & cargo pockets

Superleichtes Boardshorts Material | Gefertigt aus recyceltem PET | Zwei-wege stretch | Elastic Loop Board-Shorts Verschluss | Kniekehlen Belüftung | RV Hosen- & Cargo-Taschen



130 graphite



MATERIAL 86% Polyester, 14% Elastane
ITEM-NO. 473-510-2390

EU	XS	S	M	L	XL	XXL
*US	XXS	XS	S	M	L	XL
*ASIA	S	M	L	XL	XXL	3XL



426 washed black



FLOW XTG BIB SHORTS

Superlight X-stretch fabric with enhanced wicking | Multidirectional stretch (4-way) | Breathable, fast drying, moisture wicking | 3D antibacterial chamois/padding | Silicone anti slip print | 2 open pockets on thigh & 3 on back | 3D preformed and optimized fit

Superleichtes X-Stretch Material mit erhöhtem Feuchtigkeitstransport | Multidirektionaler stretch (4-way) | Atmungsaktiv, schnell trocknend, feuchtigkeitstransportierend | 3D antibakteriells chamois/polsterung | Silikon Anti-Rutsch Print | 2 offene Taschen am Oberschenkel & 3 am Rücken | 3D vorgeformter und optimierter Fit



MATERIAL 80% Polyamid, 20 % Elastane
ITEM-NO. 473-510-2386

EU	XS	S	M	L	XL	XXL
*US	XXS	XS	S	M	L	XL
*ASIA	S	M	L	XL	XXL	3XL



426 washed black



FLOW XTG INNER SHORTS

Superlight X-stretch fabric with enhanced wicking | Multidirectional stretch (4-way) | Breathable, fast drying, moisture wicking | 3D antibacterial chamois/padding | Silicone anti slip print | 2 open pockets on thigh | 3D preformed and optimized fit

Superleichtes X-Stretch Material mit erhöhtem Feuchtigkeitstransport | Multidirektionaler stretch (4-way) | Atmungsaktiv, schnell trocknend, feuchtigkeitstransportierend | 3D antibakteriells chamois/polsterung | Silikon Anti-Rutsch Print | 2 offene Taschen am Oberschenkel | 3D vorgeformter und optimierter Fit



MATERIAL 80% Polyamid, 20 % Elastane
ITEM-NO. 473-510-2385

EU	XS	S	M	L	XL	XXL
*US	XXS	XS	S	M	L	XL
*ASIA	S	M	L	XL	XXL	3XL



133 acacia-charcoal



CARVE X 3/4 JERSEY

Light X-stretch jersey fabric | Made from recycled PET fiber | Anti-microbial, anti-odor | 3/4 sleeves optimized for elbowguard use | Breathable, fast drying, moisture wicking | Microfiber lens-wipe

Leichtes X-Stretch Jersey Material | Gefertigt aus recyceltem PET | Anti-mikrobiell, anti-odor | 3/4 Ärmel optimiert für Ellbogenschoner | Atmungsaktiv, schnell trocknend, feuchtigkeitstransportierend | Mikrofaser Brillenputztuch



MATERIAL 95% Polyester, 5% Elastane
ITEM-NO. 473-510-2460 & 473-510-2460K

EU	KS	KM	KL	XS	S	M	L	XL	XXL
	128	140	152						
*US	KS	KM	KL	XXS	XS	S	M	L	XL
*ASIA	KS	KM	KL	S	M	L	XL	XXL	3XL

**AVAILABLE
IN KIDS SIZING**



047 marine



CARVE EVO SHORTS

Durable X-stretch fabric | Made from recycled PET fiber | Multidirectional stretch (4-way) | Internal waist adjuster | Silicone anti slip print | Zippered hand & cargo pockets

Robustes X-stretch Material | Gefertigt aus recyceltem PET | Multidirektionaler stretch (4-way) | Innenliegende Bundweitenverstellung | Silikon Anti-Rutsch Print | RV Hosen- & Cargo-Taschen

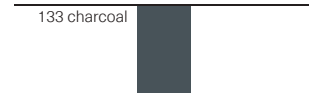

MATERIAL 88% Polyester, 12% Elastane
ITEM-NO. 473-510-0480

EU	XS	S	M	L	XL	XXL
*US	XXS	XS	S	M	L	XL
*ASIA	S	M	L	XL	XXL	3XL



133 charcoal



CARVE PANTS

Durable X-stretch fabric | Made from recycled PET fiber | Multidirectional stretch (4-way) | Internal waist adjuster | Silicone anti slip print | Back knee venting | Zippered hand & cargo pockets

Robustes X-stretch Material | Gefertigt aus recyceltem PET | Multidirektionaler stretch (4-way) | Innenliegende Bundweitenverstellung | Silikon Anti-Rutsch Print | Kniekehlen Belüftung | RV Hosen- & Cargo-Tasche



047 marine



003 black



MATERIAL 88% Polyester, 12% Elastane
ITEM-NO. 473-510-3490

EU	XS	S	M	L	XL	XXL
*US	XXS	XS	S	M	L	XL
*ASIA	S	M	L	XL	XXL	3XL



003 black



CARVE DIGGER EVO HOODED JERSEY

Durable 2.5 layer X-stretch fabric | Made from recycled PET fiber | DWR treated (water repellent) | Multidirectional stretch (4-way) | Microfiber lens-wipe | Thumbhole & Sportswatch supporting cuff (I&R) | Integrated neck tube & facemask | Underhelmet hood | Vent areated back | Zippered back pocket

Robustes 2.5 lagiges X-Stretch Material | Gemacht aus recyceltem PET | DWR wasserabweisende Imprägnierung | Multidirektionaler stretch (4-way) | Mikrofaser Brillenputztuch | Ärmel mit Daumenloch & Sportuhröffnung (I&R) | Integrierter Multifunktionsnackenschlauch | Unter-Helm Kapuze | Lüftungsöffnung am Rücken | RV Rückentasche



156 taupe-raisin



MATERIAL 88% Polyester, 12% Elastane
ITEM-NO. 473-510-3470

EU	XXS	S	M	L	XL	XXL
*US	3XS	XS	S	M	L	XL
*ASIA	XS	M	L	XL	XXL	3XL



005 acacia-black



CARVE DIGGER SHIRT

Durable X-stretch flannel fabric | *Durable X-stretch denim fabric | Made from recycled PET fiber | *Made from organic cotton | yarn dyed | *Stone washed | DWR treated (water repellent) | Silent front snap button closure | Chest pockets

Robustes X-stretch Flannel Material | *Robustes X-stretch Denim Material | Gemacht aus recyceltem PET | *Gefertigt aus Bio Baumwolle | *Zwirn gefärbt | *Stone washed | DWR wasserabweisende Imprägnierung | Druchgehende lautlose Druck-Knopfleiste | Brusttaschen



003 black-graphite



059 Washed blue (organic)



MATERIAL 64% Polyester, 33% Viscose, 3% Elastane
*96% Cotton, 4% Elastane
ITEM-NO. 473-510-1470 (flannel)
*473-510-1475 (organic denim)

EU	XS	S	M	L	XL	XXL
*US	XXS	XS	S	M	L	XL
*ASIA	S	M	L	XL	XXL	3XL



003 black



CARVE DIGGER SHORTS

Durable X-stretch fabric | Made from recycled PET fiber | Multidirectional stretch (4-way) | Internal waist adjuster & beltloops | Silicone anti slip print | Zippered hand & cargo pockets

Robustes X-stretch Material | Gefertigt aus recyceltem PET | Multidirektionaler stretch (4-way) | Innenliegende Bundweitenverstellung & Gurtschlaufen | Silikon Anti-Rutsch Print | RV Hosen- & Cargo-Taschen



MATERIAL 88% Polyester, 12% Elastane
ITEM-NO. 473-510-1480

EU	XS	S	M	L	XL	XXL
*US	XXS	XS	S	M	L	XL
*ASIA	S	M	L	XL	XXL	3XL



047 storm-marine



TRIGGER EVO LONG SLEEVE JERSEY

NEW Superlight X-stretch jersey & mesh fabric | Made from recycled PET fiber | Anti-microbial, anti-odor | Breathable, fast drying, moisture wicking | Areated mesh back | Silicone anti slip print | Elastic cuff | Size down for a tighter performance fit!

NEUES Superleichtes X-Stretch Jersey & Mesh Material | Gefertigt aus recyceltem PET | Anti-mikrobiell, anti-odor | Atmungsaktiv, schnell trocknend, feuchtigkeitstransportierend | Mesh belüfteter Rücken | Silikon Anti-Rutsch Print | Elastischer Ärmelbund | Wähle eine Grösse kleiner für einen Performance-Fit



003 anthracite-black



133 acacia-charcoal



MATERIAL Body: 95% Polyester, 5% Elastane, Back: 92% Polyester, 8% Elastane
ITEM-NO. 473-510-3570 & 473-510-3570K

EU	KS	KM	KL	XS	S	M	L	XL	XXL
*US	KS	KM	KL	XXS	XS	S	M	L	XL
*ASIA	KS	KM	KL	S	M	L	XL	XXL	3XL

**AVAILABLE
IN KIDS SIZING**



047 marine



TRIGGER EVO PANTS

Durable X-stretch fabric | Multidirectional stretch (4-way) | 3D tailored & optimized fit | Internal waist adjuster | Silicone strip on waistband | Two zippered hand pockets

Robustes X-stretch Material | Multidirektionaler stretch (4-way) | 3D vorgeformter und optimierter Fit | Innenliegende Bundweitenverstellung | Silicone strip on waistband | 2 RV Hosentaschen



003 black



133 charcoal



MATERIAL 92% Polyester, 8% Elastane
ITEM-NO. 473-510-3590 & 473-510-3590K

EU	KS	KM	KL	XS	S	M	L	XL	XXL
*US	KS	KM	KL	XXS	XS	S	M	L	XL
*ASIA	KS	KM	KL	S	M	L	XL	XXL	3XL

**AVAILABLE
IN KIDS SIZING**



426 anthracite



CARVE ALL WEATHER PANTS

Durable 2 layer X-stretch fabric | Made from recycled PET fiber | Waterproof & bearthable | WP: 10'000 & MVP 10'000 MVP | Internal waist adjuster & extra beltloops | 2 zippered handpockets

Robustes 2 lagiges X-Stretch Material | Gefertigt aus recyceltem PET | Wasserdich & Atmungsaktiv | WP: 10'000 & MVP 10'000 MVP | Innenliegende Bundweitenverstellung & extra Gurtschlaufen | 2 RV Hosentaschen



MATERIAL 95% Polyester, 5% Elastane
ITEM-NO. 473-510-2990

EU	XS	S	M	L	XL	XXL
*US	XXS	XS	S	M	L	XL
*ASIA	S	M	L	XL	XXL	3XL



971 Anthracite



FLOW WINDBREAKER JACKET

Durable 2 layer X-stretch fabric | Water-resistant & breathable | WR: 5'000 & MVP 10'000 MVP | Internal waistadjustment | 2 zippered handpockets | Integrated stuff sack | Stowable underhelmet hood | Reflective prints (front & back)

Robustes 2 lagiges X-Stretch Material | Wasserabweisend & Atmungsaktiv | WR: 5'000 & MVP 10'000 MVP | Interne Bundverstellung | 2 RV Jackentaschen | Verstaubar in eigener Tasche | Verstaubare Unter-Helm Kapuze | Rückstrahlende Drucke (vorne & hinten)



MATERIAL 100% Polyamide
ITEM-NO. 473-510-1915

EU	XS	S	M	L	XL	XXL
*US	XXS	XS	S	M	L	XL
*ASIA	S	M	L	XL	XXL	3XL

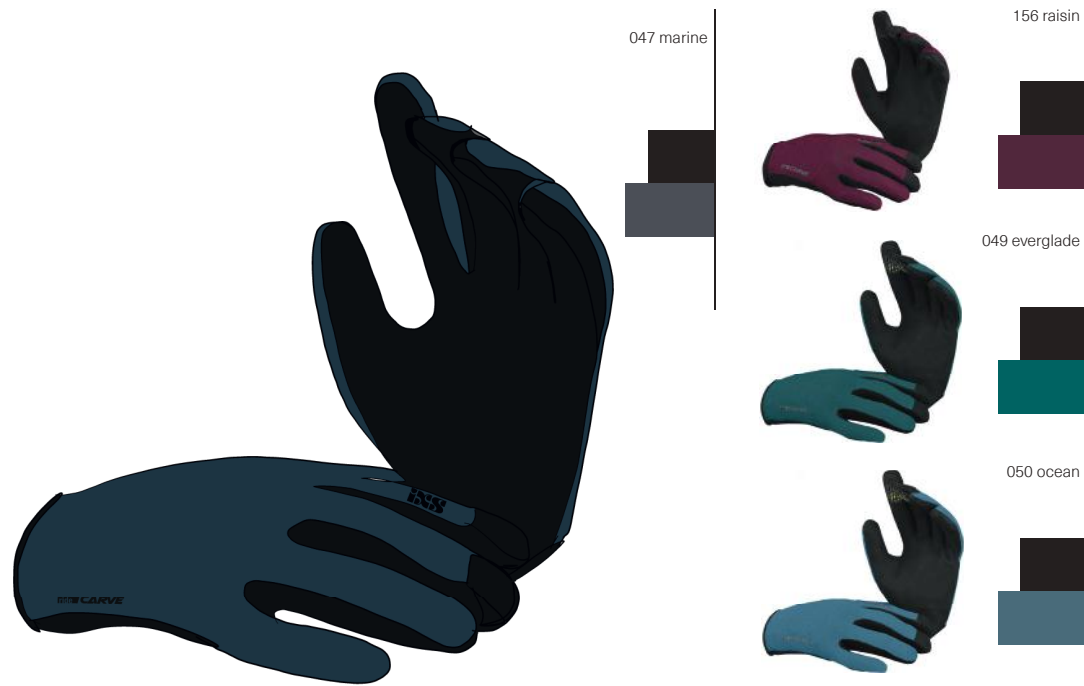

CARVE GLOVES

CARVE DIGGER GLOVES

Preformed ergonomics | Slip-on design | Abrasive palm made of synthetic leather | Reinforced fingertips | Silicone prints on index & middle finger for enhanced grip | Touchscreen compatible | Available in Kids sizing

Preformed ergonomics | Slip-on design with velcro closure | Abrasive palm made of synthetic leather | Reinforced fingertips | Silicone prints on Palm, index & middle finger for enhanced grip | Touchscreen compatible

Ergonomisch vorgeformt | Slip-on design | Robuste Kunstleder Handfläche | Verstärkte Fingerspitzen | Silikon Druck auf Zeig & Mittelfinger für besseren Griff | Touchscreen kompatibel | Erhältlich in Kindergrößen

Ergonomisch vorgeformt | Slip-on design mit Velcro Verschluss | Robuste Kunstleder Handfläche | Verstärkte Fingerspitzen | Silikon Druck auf Handflächen, Zeig & Mittelfinger für besseren Griff | Touchscreen kompatibel



**AVAILABLE
IN KIDS SIZING**

MATERIAL 90% Polyester, 10% Elasthan
ITEM-NO. 472-510-9400

EU	KS 128	KM 140	KL 152	XS	S	M	L	XL	XXL
*US	KS	KM	KL	XXS	XS	S	M	L	XL
*ASIA	KS	KM	KL	S	M	L	XL	XXL	3XL

MATERIAL 90% Polyester, 10% Elasthan
ITEM-NO. 472-510-2450

EU	XS	S	M	L	XL	XXL
*US	XXS	XS	S	M	L	XL
*ASIA	S	M	L	XL	XXL	3XL



WOMEN'S CARVE GLOVES

Preformed ergonomics | Slip-on design | Abrasive palm made of synthetic leather | Reinforced fingertips | Silicone prints on index & middle finger for enhanced grip | Touchscreen compatible

Ergonomisch vorgeformt | Slip-on design | Robuste Kunstleder Handfläche | Verstärkte Fingerspitzen | Silikon Druck auf Zeig & Mittelfinger für besseren Griff | Touchscreen kompatibel



003 black



049 everglade



MATERIAL 90% Polyester, 10% elastane
ITEM-NO. 472-510-9410

EU	XS	S	M	L
*US	XXS	XS	S	M
*ASIA	S	M	L	XL



ILLUSION ORGANIC TEE

Medium weight X-stretch fabric | Made from organic cotton | X-style factor | Regular casual fit | Natural touch and feel

Mittelschweres X-Stretch Jersey Material | Gemacht aus Bio Baumwolle | X-Style Faktor | Regular Casual Fit | Natürlicher & weicher Griff



GETOUTANDPLAY ORGANIC TEE

Medium weight X-stretch jersey fabric | Made from organic cotton | X-style factor | Regular casual fit | Natural touch and feel

Mittelschweres X-Stretch Jersey Material | Gemacht aus Bio Baumwolle | X-Style Faktor | Regular Casual Fit | Natürlicher & weicher Griff



130 graphite



MATERIAL 60% Cotton, 40% Polyester
ITEM-NO. 473-510-2032

EU	XS	S	M	L	XL	XXL	3XL
*US	XXS	XS	S	M	L	XL	XXL
*ASIA	S	M	L	XL	XXL	3XL	4XL

156 raisin



MATERIAL 60% Organic Cotton, 40% Polyester
ITEM-NO. 473-510-2031

EU	XS	S	M	L	XL	XXL	3XL
*US	XXS	XS	S	M	L	XL	XXL
*ASIA	S	M	L	XL	XXL	3XL	4XL



172 olive



BRAND TEE

Medium weight X-stretch jersey fabric | X-style factor | Regular casual fit | Natural touch and feel

Mittelschweres X-Stretch Jersey Material | X-Style Faktor | Regular Casual Fit | Natürlicher & weicher Griff



003 black



050 ocean



MATERIAL 60% Cotton, 40% Polyester
ITEM-NO. 473-510-6030

EU	XS	S	M	L	XL	XXL	3XL
*US	XXS	XS	S	M	L	XL	XXL
*ASIA	S	M	L	XL	XXL	3XL	4XL



130 graphite



CLASSIC TEE

Medium weight X-stretch jersey fabric | X-style factor | Open chest pocket | Regular casual fit | Natural touch and feel

Mittelschweres X-Stretch Jersey Material | X-Style Faktor | Offene Brusttasche | Regular Casual Fit | Natürlicher & weicher Griff



MATERIAL 60% Cotton, 40% Polyester
ITEM-NO. 473-510-6036

EU	XS	S	M	L	XL	XXL	3XL
*US	XXS	XS	S	M	L	XL	XXL
*ASIA	S	M	L	XL	XXL	3XL	4XL



156 raisin



WOMEN'S GETOUTANDPLAY ORGANIC TEE

Medium weight X-stretch jersey fabric | Made from organic cotton | X-style factor | Regular casual fit | Natural touch and feel

Mittelschweres X-Stretch Jersey Material | Gemacht aus Bio Baumwolle | X-Style Faktor | Regular Casual Fit | Natürlicher & weicher Griff*



130 graphite



MATERIAL 60% Cotton, 40% Polyester
ITEM-NO. 473-510-2036

EU	34 XS	36 S	38 M	40 L	42 XL	44 XXL
*US	XS	S	M	L	XL	XXL
*ASIA	S	M	L	XL	XXL	3XL



172 olive



WOMEN'S BRAND TEE

Medium weight X-stretch jersey fabric | X-style factor | Regular casual fit | Natural touch and feel

Mittelschweres X-Stretch Jersey Material | X-Style Faktor | Regular Casual Fit | Natürlicher & weicher Griff



MATERIAL 60% Cotton, 40% Polyester
ITEM-NO. 473-510-6033

EU	34 XS	36 S	38 M	40 L	42 XL	44 XXL
*US	XS	S	M	L	XL	XXL
*ASIA	S	M	L	XL	XXL	3XL



047 marine



WOMEN'S RIDGE TEE

Medium weight X-stretch jersey fabric | X-style factor | Regular casual fit | Natural touch and feel

Mittelschweres X-Stretch Jersey Material | X-Style Faktor | Regular Casual Fit | Natürlicher & weicher Griff



MATERIAL 60% Polyester, 40% Cotton
ITEM-NO. 473-510-1036

EU	34	36	38	40	42	44
	XS	S	M	L	XL	XXL
*US	XS	S	M	L	XL	XXL
*ASIA	S	M	L	XL	XXL	3XL



130 graphite



DIGGER DENIM PANTS

Durable X-stretch denim fabric | X-style factor | Tapered Slim fit | Button fly | Classic five pocket design

Robustes X-stretch Denim Material | X-Style Faktor | Tapered Slim fit | Knöpfe am Hosenschlitz | Klassisches 5 Pocket Design



MATERIAL 70% Cotton, 26% Polyester, 4% Elastane
ITEM-NO. 473-510-1090

EU	28/30	30/32	32/32	34/34	36/34	38/34
	XS	S	M	L	XL	XXL
*US	XXS	XS	S	M	L	XL
*ASIA	S	M	L	XL	XXL	3XL

003 black



172 olive



DIGGER SUNBRERO

Made from organic hemp | X-style factor | DWR treated (water repellent) | Adjustable headband | Venting holes | Secret stash-pocket with velco closure | Adjustable chinstrap

Gefertigt aus Bio Hanf | X-style factor | DWR wasserabweisende Imprägnierung | Kopfumfach einstellbar | Belüftungslöcher | Geheimtasche mit Velcro-Verschluss | Verstellbarer Kordelzug



903 coffee



MATERIAL 55% Cotton, 35% Hemp, 15% Polyester
ITEM-NO. 473-510-3405

EU	OS
*US	OS
*ASIA	OS

130 graphite



BEAN HUGGER BEANIE

Made from wool | X-style factor | Anti-odor & antimicrobial by nature | Yarn dyed | Natural touch and feel

Aus Schafswolle gefertigt | X-Style Faktor | Natürlich Anti-mikrobiell, anti-odor | Faser gefärbt | Natürlicher & weicher Griff



003 black



MATERIAL 60% Wool, 40% Acrylic
ITEM-NO. 473-510-2089

EU	OS
*US	OS
*ASIA	OS



803 camel



BRAND HAT

X-style factor | EMB logo | Snap back | Flat visor | Venting holes
 X-style factor | Gesticktes Logo | Snap back | Flacher Schirm | Belüftungslöcher*



009 grey



PLAYGROUND CURVED HAT

X-style factor | EMB logo | Snap back | Curved visor | Venting holes
 X-style factor | Gesticktes Logo | Snap back | Runder Schirm | Belüftungslöcher



MATERIAL 83% Acrylic, 15 % Wool, 2% Elastane
 ITEM-NO. 473-510-6988

EU	OS
*US	OS
*ASIA	OS

MATERIAL Front:100% Acrylic; Mesh:100% Polyester
 ITEM-NO. 473-510-2046

EU	OS
*US	OS
*ASIA	OS



156 raisin camo



DOUBLE SOCKS

Set of 2 | Made from sheeps wool | Classic crew length | Midfoot & calf compression | fast drying & moisture wicking | Available in 3 colorways

Doppelpack | Gemacht aus Schafswolle | Mittlere Länge | Mittelfuss & Wadenkompression | schnell trocknend & feuchtigkeitstransportierend | Verfügbar in 3 Farbvarianten

172 olive



003 black



MATERIAL 80% Cotton, 15% Polyamide, 5 % Elastane
ITEM-NO. 473-510-2050

EU	S	M	L
	36-39	40-42	43-46
*US	S	M	L
*ASIA	S	M	L



XULT DH HELMET

FRP reinforced helmet shell | Vortex ventilation system with integrated air channels | Xmatter/Xrail impact absorption liner | adjustable visor | washable padding | double-D safety closure | EN1078, CPSC, ASTM, KC

FRP verstärkte Helmschale | Vortex Belüftungssystem mit integrierten Kanälen | Xmatter/Xrail Absorptionseinlage | verstellbares Visier | waschbare Polsterung | double-D Sicherheitsverschluss | EN1078, CPSC, ASTM, KC

005 acacia-black



XULT DH HELMET

FRP reinforced helmet shell | Vortex ventilation system with integrated air channels | Xmatter/Xrail impact absorption liner | adjustable visor | washable padding | double-D safety closure | EN1078, CPSC, ASTM, KC

FRP verstärkte Helmschale | Vortex Belüftungssystem mit integrierten Kanälen | Xmatter/Xrail Absorptionseinlage | verstellbares Visier | waschbare Polsterung | double-D Sicherheitsverschluss | EN1078, CPSC, ASTM, KC

047 marine-black



001 white-black



003 black-graphite



ITEM-NO. 470-510-3000

ALPHA	SM	ML	LXL
CM	53-56	57-59	60-62



003 black



ITEM-NO. 470-510-1510

ALPHA	SM	ML	LXL
CM	53-56	57-59	60-62



050 ocean-marine



XACT EVO HELMET

ABS helmet shell | Voretex ventilation system with integrated air channels | adjustable visor | washable padding | double-D safety closure | EN1078, CPSC, ASTM, KC

ABS Helmschale | Vortex™, Belüftungssystem mit integrierten Luftkanälen | Verstellbares Visier | Waschbare Polsterung | Doppel-D Sicherheitsverschluss | EN1078, CPSC, ASTM, KC



003 black-graphite



XACT EVO HELMET

ABS helmet shell | Voretex ventilation system with integrated air channels | adjustable visor | washable padding | double-D safety closure | EN1078, CPSC, ASTM, KC

ABS Helmschale | Vortex, Belüftungssystem mit integrierten Luftkanälen | Verstellbares Visier | Waschbare Polsterung | Doppel-D Sicherheitsverschluss | EN1078, CPSC, ASTM, KC

001 white-chalk



003 black-graphite



ITEM-NO. 470-510-3010

ALPHA	XS	SM	ML	LXL
CM	49-53	53-56	57-59	60-62

ITEM-NO. 470-510-9008

ALPHA	XS	SM	ML	LXL
CM	49-53	53-56	57-59	60-62



502 chalk

TRIGGER FF MIPS HELMET

Mips brain protection system | Patented all-in-one Inmould technology, external and internal ventilation channels | Adjustable, goggle compatible visor | Dial adjuster with precision interlocking | ErgoFit Ultra system for horizontal and vertical adjustment | Double-Inmould, 360° Inmould shell | Adjustable straps | Magnetic closure | EN1078, CPSC, KC, ASTM | +/- 595g (SM 54-58cm)

Mips brain protection system | Patentierte «all-in-one» Inmould Technologie, externe und interne Belüftungskanäle | Google kompatibles und 2-stufig verstellbares Visier | Verstellrad mit Präzisionsverzahnung | ErgoFit Ultra System mit horizontaler und vertikaler Verstellung | Doppel-Inmould, 360° Inmould Schale | Verstellbare Riemen | Magnetverschluss | EN1078, CPSC, KC, ASTM | +/- 595g (SM 54-58cm)



003 black-camo

TRIGGER FF MIPS HELMET

Mips protection system | Patented all-in-one Inmould technology, external and internal ventilation channels | Adjustable, goggle compatible visor | Dial adjuster with precision interlocking | ErgoFit Ultra system for horizontal and vertical adjustment | Double-Inmould, 360° Inmould shell | Adjustable straps | Magnetic closure | EN1078, CPSC, KC, ASTM | +/- 595g (SM 54-58cm)

Mips brain protection system | Patentierte «all-in-one» Inmould Technologie, externe und interne Belüftungskanäle | Google kompatibles und 2-stufig verstellbares Visier | Verstellrad mit Präzisionsverzahnung | ErgoFit Ultra System mit horizontaler und vertikaler Verstellung | Doppel-Inmould, 360° Inmould Schale | Verstellbare Riemen | Magnetverschluss | EN1078, CPSC, KC, ASTM | +/- 595g (SM 54-58cm)



005 acacia



155 taupe



003 black



009 camo grey

ITEM-NO. 470-510-3020
*All including a second set of padding 15 & 25mm

ALPHA	XS	SM	ML
CM	49-54	54-58	58-62

ITEM-NO. 470-510-1001 & 470-510-1002
*All including a second set of padding 15 & 25mm

ALPHA	XS	SM	ML
CM	49-54	54-58	58-62

HELMETS.



130 graphite

TRIGGER FF HELMET

Patented all-in-one Inmould technology, external and internal ventilation channels | Adjustable, goggle compatible visor | Dial adjuster with precision interlocking | ErgoFit Ultra system for horizontal and vertical adjustment | Double-Inmould, 360° Inmould shell | Adjustable straps | Magnetic closure | EN1078, CPSC, KC, ASTM | +/- 595g (SM 54-58cm)

Patentierte «all-in-one» Inmould Technologie, externe und interne Belüftungskanäle | Google kompatibles und 2-stufig verstellbares Visier | Verstellrad mit Präzisionsverzahnung | ErgoFit Ultra System mit horizontaler und vertikaler Verstellung | Doppel-Inmould, 360° Inmould Schale | Verstellbare Riemen | Magnetverschluss | EN1078, CPSC, KC, ASTM | +/- 595g (SM 54-58cm)

003 black



047 marine



001 white



ITEM-NO. 470-510-9010

*All including a second set of padding 15 & 25 mm

	ALPHA	XS	SM	ML
CM	49-54	54-58	58-62	

HELMETS.



155 taupe

TRIGGER AM MIPS HELMET

Mips protection system | Inmould technology, external and internal ventilation channels | Adjustable, goggle compatible visor | Dial adjuster with precision interlocking | ErgoFit Ultra system for horizontal and vertical adjustment | Double-Inmould, 360° Inmould shell | Adjustable straps | Magnetic closure | EN1078, CPSC, KC

Mips brain protection system | Inmould Technologie, externe und interne Belüftungskanäle | Goggle kompatibles und 3-stufig verstellbares Visier | Verstellrad mit Präzisionsverzahnung | ErgoFit Ultra System mit horizontaler und vertikaler Verstellung | Doppel-Inmould, 360° Inmould Schale | Verstellbare Riemen | Magnetverschluss | EN1078, CPSC, KC

005 acacia



502 chalk



ITEM-NO. 470-510-3110

	ALPHA	SM	M	ML
CM	54-58	56-60	58-62	



TRIGGER AM MIPS HELMET

Mips protection system | Inmould technology, external and internal ventilation channels | Adjustable, goggle compatible visor | Dial adjuster with precision interlocking | ErgoFit Ultra system for horizontal and vertical adjustment | Double-Inmould, 360° Inmould shell | Adjustable straps | Magnetic closure | EN1078, CPSC, KC

Mips brain protection system | Inmould Technologie, externe und interne Belüftungskanäle | Goggle kompatibles und 3-stufig verstellbares Visier | Verstellrad mit Präzisionsverzahnung | ErgoFit Ultra System mit horizontaler und vertikaler Verstellung | Doppel-Inmould, 360° Inmould Schale | Verstellbare Riemen | Magnetverschluss | EN1078, CPSC, KC



TRIGGER AM HELMET

Inmould technology, external and internal ventilation channels | Adjustable, goggle compatible visor | Dial adjuster with precision interlocking | ErgoFit Ultra system for horizontal and vertical adjustment | Double-Inmould, 360° Inmould shell | Adjustable straps | Magnetic closure | EN1078, CPSC, KC

Inmould Technologie, externe und interne Belüftungskanäle | Goggle kompatibles und 3-stufig verstellbares Visier | Verstellrad mit Präzisionsverzahnung | ErgoFit Ultra System mit horizontaler und vertikaler Verstellung | Doppel-Inmould, 360° Inmould Schale | Verstellbare Riemen | Magnetverschluss | EN1078, CPSC, KC



ITEM-NO. 470-510-1111 & 470-510-1112

ALPHA	SM	M	ML
CM	54-58	56-60	58-62



ITEM-NO. 470-510-9110

ALPHA	SM	M	ML
CM	54-58	56-60	58-62

HELMETS.



170 sage



TRAIL EVO MIPS HELMET

Mips protection system | Inmould technology, external and internal ventilation channels | Adjustable visor | Dial adjuster with precision interlocking | ErgoFit Ultra system for horizontal and vertical adjustment | Double-Inmould, 360° Inmould shell | Adjustable straps | EN1078, CPSC, KC

Mips brain protection system | Inmould Technologie, externe und interne Belüftungskanäle | Verstellbares Visier | Verstellrad mit Präzisionsverzahnung | ErgoFit Ultra System mit horizontaler und vertikaler Verstellung | Doppel-Inmould, 360° Inmould Schale | Verstellbare Riemen | EN1078, CPSC, KC

HELMETS.



003 black



TRAIL EVO HELMET

Inmould technology, external and internal ventilation channels | Adjustable visor | Dial adjuster with precision interlocking | ErgoFit Ultra system for horizontal and vertical adjustment | Double-Inmould, 360° Inmould shell | Adjustable straps | EN1078, CPSC, KC

Inmould Technologie, externe und interne Belüftungskanäle | Verstellbares Visier | Verstellrad mit Präzisionsverzahnung | ErgoFit Ultra System mit horizontaler und vertikaler Verstellung | Doppel-Inmould, 360° Inmould Schale | Verstellbare Riemen | EN1078, CPSC, KC

009 grey



023 mars



047 marine



003 black



ITEM-NO. 470-510-1130

ALPHA	XS	SM	ML	XLW
CM	49-54	54-58	58-62	58-62 WIDE

050 ocean



130 graphite



048 lagoon



156 raisin



ITEM-NO. 470-510-9120

ALPHA	XS	SM	ML	XLW
CM	49-54	54-58	58-62	58-62 WIDE



TRAIL XC EVO HELMET

Inmould technology, external and internal ventilation channels
 Adjustable visor | Dial adjuster with precision interlocking | ErgoFit Ultra system for horizontal and vertical adjustment
 Double-Inmould, 360° Inmould shell | Adjustable straps | EN1078, CPSC, KC

Inmould Technologie, externe und interne Belüftungskanäle | Verstellbares Visier
 Verstellrad mit Präzisionsverzahnung | ErgoFit Ultra System mit horizontaler und vertikaler Verstellung | Doppel-Inmould,
 360° Inmould Schale | Verstellbare Riemen | EN1078, CPSC, KC

009 grey



021 fluo red



048 lagoon



ITEM-NO. 470-510-1120

ALPHA	XS	SM	ML
CM	49-54	54-58	58-62



TRIGGER+ POLARIZED GOGGLE

Wide, unobstructed field of vision (178°x78°) | 3-ply foam for increased comfort | 45mm elastic strap | Outriggers with universal helmet compatibility | Polarized and non-polarized lens options, both with anti-fog and anti-scratch treatment | EN1938:2010 | Optional: Low Profile (LP) sizing, 5mm smaller lens profile to compensate smaller heads and/or smaller sized helmets

Weitsichtwinkel für ungehindertes Blickfeld (178°x78°) | 3-Lagen Schaum für verbesserten Komfort | 45mm Brillenband | Outriggers für perfekte Einpassung mit div. Helmen | EN1938 zertifiziert | Roll-Off Kit vorinstalliert (für Links- und Rechtshänder) | Linsen: | Roll-Off Kit | mirrored lens, anti-fog, anti-scratch | clear double lens



ITEM-NO. 469-510-9011

EU	OS
*US	OS
*ASIA	OS



TRIGGER+ ROLL-OFF GOGGLE

Wide, unobstructed field of vision (178°x78°) | 3-ply foam for increased comfort | 45mm elastic strap | Outriggers with universal helmet compatibility | EN1938 certified | Roll-Off Kit pre-assembled (for left and right handed) | Lenses: Roll-Off Kit | mirrored lens, anti-fog, anti-scratch | clear double lens

Weitsichtwinkel für ungehindertes Blickfeld (178°x78°) | 3-Lagen Schaum für verbesserten Komfort | 45mm Brillenband | Outriggers für perfekte Einpassung mit div. Helmen | EN1938 zertifiziert | Roll-Off Kit vorinstalliert (für Links- und Rechtshänder) | Linsen: Roll-Off Kit | mirrored lens, anti-fog, anti-scratch | clear double lens



ITEM-NO. 469-510-9010

EU	OS
*US	OS
*ASIA	OS



003 black-mirror gold

TRIGGER GOGGLE

Wide, unobstructed field of vision (178°x78°) | 3-ply foam for increased comfort | 45mm elastic strap | Outriggers with universal helmet compatibility | EN1938:2010 | Optional: Low Profile (LP) sizing, 5mm smaller lens profile to compensate smaller heads and/or smaller sized helmets

Weitsichtwinkel für ungehindertes Blickfeld (178°x78°) | 3-Lagen Schaum für verbesserten Komfort | 45mm Brillenband | Outriggers für perfekte Einpassung mit div. Helmen | EN1938 zertifiziert | Optional: Polarisierte und nicht-polarisierte Gläser, beide mit Anti-Beschlag- und Anti-Kratz-Ausrüstung



030 racing red-clear

TRIGGER CLEAR GOGGLE

Wide, unobstructed field of vision (178°x78°) | 3-ply foam for increased comfort | 45mm elastic strap | Outriggers with universal helmet compatibility | EN1938:2010 | Optional: Low Profile (LP) sizing, 5mm smaller lens profile to compensate smaller heads and/or smaller sized helmets

Weitsichtwinkel für ungehindertes Blickfeld (178°x78°) | 3-Lagen Schaum für verbesserten Komfort | 45mm Brillenband | Outriggers für perfekte Einpassung mit div. Helmen | EN1938 zertifiziert | Optional: Polarisierte und nicht-polarisierte Gläser, beide mit Anti-Beschlag- und Anti-Kratz-Ausrüstung

001 white-mirror silver



030 racing red-mirror crimson



033 black-mirror rose



001 white-clear



003 black-clear



049 everglade-clear



049 everglade-mirror cobalt



062 burnt orange-mirror rose



172 olive-mirror gold



062 burnt orange-clear



172 olive-clear



ITEM-NO. 469-510-9020

EU	OS	LP
*US	OS	LP
*ASIA	OS	LP

ITEM-NO. 469-510-9021

EU	OS	LP
*US	OS	LP
*ASIA	OS	LP



172 olive-mirror gold

HACK GOGGLE

Wide, unobstructed field of vision (178°x78°) | 2-ply foam for increased comfort | 40mm elastic strap | Polarized and non-polarized lens options, both with anti-fog and anti-scratch treatment | EN1938:2010

Weitsichtwinkel für ungehindertes Blickfeld (178°x78°) | 2-lagiger Schaumstoff für erhöhten Komfort | 40mm Brillenband | Polariserte und nicht-polarisierte Gläser, beide mit Anti-Beschlag- und Anti-Kratz-Ausrüstung | EN1938:2010



043 racing blue-clear

HACK CLEAR GOGGLE

Wide, unobstructed field of vision (178°x78°) | 2-ply foam for increased comfort | 40mm elastic strap | Polarized and non-polarized lens options, both with anti-fog and anti-scratch treatment | EN1938:2010

Weitsichtwinkel für ungehindertes Blickfeld (178°x78°) | 2-lagiger Schaumstoff für erhöhten Komfort | 40mm Brillenband | Polariserte und nicht-polarisierte Gläser, beide mit Anti-Beschlag- und Anti-Kratz-Ausrüstung | EN1938:2010 zertifiziert

003 black-mirror gold



030 racing red-mirror crimson



043 racing blue-mirror cobalt



003 black-clear



030 racing red-clear



172 olive-clear



ITEM-NO. 469-510-9030

EU	OS
*US	OS
*ASIA	OS

ITEM-NO. 469-510-9031

EU	OS
*US	OS
*ASIA	OS



TRIGGER UPPER BODY PROTECTIVE

Xmatter protective foam at back, shoulders and elbows (removable & exchangeable) | Impact absorbing NockOut padding at chest and ribs | FlexZip zipper that bends and flexes with movement | Available in youth sizing | EN1621-2:2014 L1 (back), EN1621-1:2012 L1 (shoulder/elbow)

Xmatter Protektionsschaum am Rücken, Schultern und Ellbogen (herausnehmbar) | NockOut Polsterung im Brust- und Rippenbereich | FlexZip, dehnbarer YKK Reissverschluss für erhöhten ergonomischer Komfort | Kindergrößen erhältlich | EN1621-2:2014 L1 (Rücken), EN1621:2012 L1 (Schulter/Elbogen)



**AVAILABLE
IN KIDS SIZING**

ITEM-NO. 482-510-6895

EU	KS	KM	KL	XS/S	S/M	M/L	L/XL	XXL
	128	140	152					
*US	KS	KM	KL	XS/S	S/M	M/L	L/XL	XXL
*ASIA	KS	KM	KL	XS/S	S/M	M/L	L/XL	XXL



CARVE UPPER BODY PROTECTIVE

Xmatter protective foam at back and shoulders (removable & exchangeable) | Impact absorbing NockOut padding at chest and ribs | FlexZip zipper that bends and flexes with movement | Available in youth sizing | EN1621-2:2014 L1 (back) / EN1621-1:2012 L1 (shoulder)

Xmatter Protektionsschaum am Rücken und den Schultern (herausnehmbar) | NockOut Polsterung im Brust- und Rippenbereich | FlexZip, dehnbarer YKK Reissverschluss für erhöhten ergonomischer Komfort | Kindergrößen erhältlich | EN1621-2:2014 L1 (Rücken), EN1621:2012 L1 (Schulter)



**AVAILABLE
IN KIDS SIZING**

ITEM-NO. 482-510-6900

EU	KS	KM	KL	XS/S	S/M	M/L	L/XL	XXL
	128	140	152					
*US	KS	KM	KL	XS/S	S/M	M/L	L/XL	XXL
*ASIA	KS	KM	KL	XS/S	S/M	M/L	L/XL	XXL



FLOW UPPER BODY PROTECTIVE

Protective Xmatter foam at back (removable & exchangeable) | FlexZip zipper that bends and flexes with movement | Stash pockets | Available in youth sizing | EN1621-2:2014 L1 (back)

Xmatter Protektionsschaum am Rücken | FlexZip, dehnbarer YKK Reissverschluss für erhöhten ergonomischer Komfort | zwei kleine integrierte Hüfttaschen | auch in Kindergrößen erhältlich | EN1621-2:2014 L1 (Rücken)



**AVAILABLE
IN KIDS SIZING**

ITEM-NO. 482-510-6905

EU	KS 128	KM 140	KL 152	XS/S	S/M	M/L	L/XL	XXL
*US	KS	KM	KL	XS/S	S/M	M/L	L/XL	XXL
*ASIA	KS	KM	KL	XS/S	S/M	M/L	L/XL	XXL



HEX UPPER BODY PROTECTIVE

HexMatter, hexagonal 3D energy absorbent impact shell technology | Ventilated and ergonomically designed to perform best comfort and protection | Protected back, chest, shoulders and elbows, adjustable to fit | Shortened upper body comfort mesh jacket | Center zipper | EN1621-2:2014 L1 (back) / EN1621-1:2012 L1 (shoulder/ elbow)

HexMatter, sechseckige energieabsorbierende 3D-Aufprallschalen-Technologie | Belüftet und ergonomisch geformt, um besten Komfort und Schutz zu bieten | Geschützter Rücken, Brust, Schulter- und Ellbogenbereich, anpassbar für verkürzte Oberkörper | Zentraler Reißverschluss | EN1621-2:2014 L1 (Rücken) / EN1621-1:2012 L1 (Schulter/ Ellbogen)



**AVAILABLE
IN KIDS SIZING**

ITEM-NO. 482-510-3700

EU	KL 152	XS/S	S/M	M/L	L/XL
*US	KL	XS/S	S/M	M/L	L/XL
*ASIA	KL	XS/S	S/M	M/L	L/XL



009 graphite



TRIGGER LOWER PROTECTIVE

Integrated chamois | Moisture wicking | Impact certified hip protectors | NockOut thigh padding | Compression fit | EN1621-1:2012 L1 (Hip)

integriertes Sitzpolster | feuchtigkeitstransportierend | Aufprall zertifizierte Hüftpolsterung | NockOut Oberschenkelpolsterung | Kompressions fit | EN1621-1:2012 L1 (Hüfte)



ITEM-NO. 482-510-1100

EU	KS 128	KM 140	KL 152	XS	S	M	L	XL
----	-----------	-----------	-----------	----	---	---	---	----

**AVAILABLE
IN KIDS SIZING**



003 black



TRIGGER RACE KNEE GUARD

Ergonomically formed Xmatter protection foam (removable & exchangeable) | Low friction impact hard-shells to absorb and distribute impact | Asymmetrical design | Anatomically formed for improved comfort, flexibility and function | AeroMesh - light, moisture wicking, breathable, anti-bacterial | LoopLock closures | Silicone stopper | EN1621-1:2012 (L1)

Ergonomisch vorgeformte Xmatter Polsterung (austauschbar) | Protektionsschalen zu zusätzlichen Absorbierung von Aufprallenergie | Asymmetrisches Design | Verbesserter Komfort durch anatomische Passform und Funktion | AeroMesh, leicht, feuchtigkeitstransportierend, atmungsaktiv, antibakteriell, hohe Festigkeit, bester Komfort | LoopLock Verschlüsse | Silikon Stopper | EN1621:2012 (L1)



ITEM-NO. 482-510-1110

EU	S	M	L	XL	XXL
----	---	---	---	----	-----



003 black



CARVE RACE KNEE & ELBOW GUARDS

Xmatter protection foam (removable & exchangeable) | Low friction impact hard-shell to absorb and distribute impact | AeroMesh- light, moisture wicking, breathable, anti-bacterial | LoopLock closures | Silicone stopper | EN1621-1:2012 (L1)

Xmatter Polsterung (austauschbar) | Protektionsschalen zu zusätzlichen Absorbierung von Aufprallenergie | AeroMesh, leicht, feuchtigkeitstransportierend, atmungsaktiv, antibakteriell, hohe Festigkeit, bester Komfort | LoopLock Verschlüsse | Silikon Stopper | EN1621-1:2012 (L1)



elbow guards

ITEM-NO. 482-510-1120 (BLACK - KNEE)
482-510-1121 (BLACK - ELBOW)

EU S M L XL XXL



003 black



HACK EVO RACE KNEE & ELBOW GUARDS

Xmatter, protective padding | Low friction impact hard-shell to absorb and distribute impact | AeroMesh- light, moisture wicking, breathable, anti-bacterial | Silicone stopper | EN1621-1:2012 (L1)

Xmatter, Schutzpolsterung | Protektionsschalen zur zusätzlichen Absorbierung von Aufprallenergie | AeroMesh, leicht, feuchtigkeitstransportierend, atmungsaktiv, antibakteriell | Silikon-Stopper | EN1621-1:2012 (L1)



elbow guards

ITEM-NO. 482-510-1130 (BLACK - KNEE)
482-510-1131 (BLACK - ELBOW)

EU S M L XL XXL



003 black



CARVE 2.0 KNEE & ELBOW GUARDS

Xmatter protection foam (exchangeable & removable) | Elasticated upper & lower hem for improved comfort and security | AeroMesh- light, moisture wicking, breathable, anti-bacterial | LoopLock closures | Silicone stopper | Available in youth sizing | EN1621-1:2012 (L1)

Xmatter Protektionsschaum (herausnehmbar) | Elastischer oberer und unterer Saum für mehr Komfort und Sicherheit | AeroMesh, leicht, feuchtigkeitstransportierend, atmungsaktiv, antibakteriell | LoopLock Verschlüsse | Silikon Stopper | auch in Kindergrößen erhältlich | EN1621-1:2012 (L1)



elbow guards

**AVAILABLE
IN KIDS SIZING**

ITEM-NO. 482-510-3420 (BLACK - KNEE)
482-510-3421 (BLACK - ELBOW)

EU	KS 128	KM 140	KL 152	XS	S	M	L	XL	XXL
----	-----------	-----------	-----------	----	---	---	---	----	-----



009 grey



172 olive



CARVE EVO+ RACE KNEE & ELBOW GUARDS

Xmatter protection foam (exchangeable & removable) | AeroMesh- light, moisture wicking, breathable, anti-bacterial | LoopLock closures | Silicone stopper | Available in youth sizing | EN1621-1:2012 (L1)

Xmatter Polsterung (austauschbar) | AeroMesh, leicht, feuchtigkeitstransportierend, atmungsaktiv, antibakteriell, hohe Festigkeit, bester Komfort | LoopLock Verschlüsse | Silikon-Stopper | auch in Kindergrößen erhältlich | EN1621-1:2012 (L1)



elbow guards

**AVAILABLE
IN KIDS SIZING**

ITEM-NO. 482-510-6616 (KNEE)
482-510-6614 (ELBOW)

EU	KS 128	KM 140	KL 152	XS	S	M	L	XL	XXL
----	-----------	-----------	-----------	----	---	---	---	----	-----



FLOW ZIP KNEE GUARDS

Xmatter protective foam (exchangeable and removable) | FlexZip zipper | AeroMesh- light, moisture wicking, breathable, anti-bacterial | LoopLock closures | Silicone stopper | EN1621-1:2012 (L1)

Xmatter Protektionsschaum (herausnehmbar) | FlexZip, dehnbarer YKK Reissverschluss | AeroMesh, leicht, feuchtigkeitstransportierend, atmungsaktiv, antibakteriell, hohe Festigkeit und bester Komfort | LoopLock Verschlüsse | Silikon-Stopper | EN1621-1:2012 (L1)

ITEM-NO. 482-510-6617

- EU
- S
- M
- L
- XL
- XXL



FLOW 2.0 KNEE & ELBOW GUARDS

Xmatter protection foam (exchangeable & removable) | Elasticated upper & lower hem for improved comfort and security | AeroMesh- light, moisture wicking, breathable, anti-bacterial | LoopLock closures | Silicone stopper | EN1621-1:2012 (L1)

Xmatter Protektionsschaum (herausnehmbar) | Elastischer oberer und unterer Saum für mehr Komfort und Sicherheit | AeroMesh, leicht, feuchtigkeitstransportierend, atmungsaktiv, antibakteriell, hohe Festigkeit und bester Komfort | LoopLock Verschlüsse | Silikon Stopper | EN1621-1:2012 (L1)



elbow guards

ITEM-NO. 482-510-3320 (KNEE)
482-510-3321 (ELBOW)

- EU
- S
- M
- L
- XL
- XXL



FLOW EVO+ KNEE & ELBOW GUARDS

Xmatter protective foam (exchangeable and removable) | AeroMesh- light, moisture wicking, breathable, anti-bacterial | LoopLock closures | Silicone stopper | EN1621-1:2012 (L1)

Xmatter Protektionsschaum (herausnehmbar) | AeroMesh, leicht, feuchtigkeitstransportierend, atmungsaktiv, antibakteriell, hohe Festigkeit und bester Komfort | LoopLock Verschlüsse | Silikon-Stopper | EN1621-1:2012 (L1)



elbow guards

ITEM-NO. 482-510-6618 (KNEE)
482-510-6619 (ELBOW)

EU	S	M	L	XL	XXL
----	---	---	---	----	-----



FLOW LIGHT KNEE & ELBOW GUARDS

Xmatter protective foam (exchangeable and removable) | Lycra mesh - light, moisture wicking, breathable, Anti-bacterial | Silicone stopper | EN1621-1:2012 (L1)

Xmatter Protektionsschaum (herausnehmbar) | Lycra Mesh, leicht, feuchtigkeitstransportierend, atmungsaktiv, antibakteriell | Silikon Stopper | EN1621-1:2012 (L1)



elbow guards

ITEM-NO. 482-510-2620 (KNEE)
482-510-2621 (ELBOW)

EU	XS	S	M	L	XL	XXL
----	----	---	---	---	----	-----



003 black



HACK EVO+ KNEE & ELBOW GUARDS

Qmatter, protective padding | AeroMesh- light, moisture wicking, breathable, anti-bacterial | Silicone stopper | Available in youth sizing | EN1621-1:2012 (L1)

Xmatter Protektionsschaum (herausnehmbar) | Lycra Mesh, leicht, feuchtigkeitstransportierend, atmungsaktiv, antibakteriell | Silikon Stopper | auch in Kindergrößen erhältlich | EN1621-1:2012 (L1)



elbow guards

**AVAILABLE
IN KIDS SIZING**

ITEM-NO. 482-510-2635 (KNEE)
482-510-2636 (ELBOW)

EU	KS 128	KM 140	KL 152	XS	S	M	L	XL	XXL
----	-----------	-----------	-----------	----	---	---	---	----	-----



009 black



CLEAVER KNEE-SHIN GUARDS

ArmadilloDuo compression shells | AeroMesh- light, moisture wicking, breathable, anti-bacterial | Squeezebox flexible joints | KneeGusset for prevention of rolling and optimizes impact absorption | LoopLock closures | Silicone stopper | EN1621-1:2012 (L1)

ArmadilloDuo Kompressionsschalen | AeroMesh, leicht, feuchtigkeitstransportierend, atmungsaktiv, antibakteriell | Squeezebox, bewegliches Gelenk | KneeGusset, verhindert das Wegrollen und optimiert die Aufprallabsorption | LoopLock Verschlüsse | Silikon-Stopper | EN1621-1:2012 (L1)

ITEM-NO. 482-510-3500

EU	S	M	L	XL
----	---	---	---	----



003 black



DAGGER KNEE GUARDS

ArmadilloDuo compression shells | AeroMesh- light, moisture wicking, breathable, anti-bacterial | Squeezebox flexible joints | KneeGusset for prevention of rolling and optimization of impact absorption | LoopLock closures | Silicone stopper | EN1621-1:2012 (L1)

ArmadilloDuo Kompressionsschalen | AeroMesh, leicht, feuchtigkeitstransportierend, atmungsaktiv, antibakteriell | Squeezebox, bewegliches Gelenk | KneeGusset, verhindert das Wegrollen und optimiert die Aufprallabsorption | LoopLock Verschlüsse | Silicon-Stopper | EN1621-1:2012 (L1)

ITEM-NO. 482-510-3605

EU S M L XL



003 black



MALLET KNEE-/SHIN GUARDS

ArmadilloDuo compression shells | AeroMesh- light, moisture wicking, breathable, anti-bacterial | Squeezebox flexible joints | KneeGusset for prevention of rolling and optimization of impact absorption | LoopLock closures | Silicone stopper | EN1621-1:2012 (L1)

ArmadilloDuo Kompressionsschalen | AeroMesh, leicht, feuchtigkeitstransportierend, atmungsaktiv, antibakteriell | Squeezebox, bewegliches Gelenk | KneeGusset, verhindert das Wegrollen und optimiert die Aufprallabsorption | LoopLock Verschlüsse | Silicon-Stopper | EN-1621-1:2012 (L1)

ITEM-NO. 482-510-4500

EU S M L XL



003 black



HEX+ KNEE & ELBOW GUARDS

HexMatter, hexagonal 3D energy absorbent impact shell technology | Ventilated and ergonomically designed to perform best comfort and protection | Protected knees & shins | AeroMesh light, moisture wicking, breathable, anti-bacterial | LoopLock closures | Silicone stopper | EN1621-1:2012 (L1)

HexMatter, sechseckige energieabsorbierende 3D-Aufprallschalen-Technologie | Belüftet und ergonomisch geformt, um besten Komfort und Schutz zu bieten | Geschützte Knie und Schienbeine | AeroMesh leicht, feuchtigkeitstransportierend, atmungsaktiv, antibakteriell | LoopLock-Verschlüsse | Silikon-Stopper | EN1621-1:2012 (L1)



elbow guards

ITEM-NO. 482-510-3720 (KNEE)
482-510-3721 (ELBOW)

**AVAILABLE
IN KIDS SIZING**

EU	KS 128	KM 140	KL 152	XS	S	M	L	XL	XXL
----	-----------	-----------	-----------	----	---	---	---	----	-----



003 black



HEX KNEE & ELBOW GUARDS

HexMatter, hexagonal 3D energy absorbent impact shell technology | LoopLock closures | Silicone stopper | EN1621-1:2012 (L1)

HexMatter, sechseckige energieabsorbierende 3D-Aufprallschalen-Technologie | Belüftet und ergonomisch geformt, um besten Komfort und Schutz zu bieten | LoopLock-Verschlüsse | Silikon-Stopper | EN1621-1:2012 (L1)



elbow guards

ITEM-NO. 482-510-3730 (KNEE)
482-510-3731 (ELBOW)

**AVAILABLE
IN KIDS SIZING**

EU	KS 128	KM 140	KL 152	XS	S	M	L	XL	XXL
----	-----------	-----------	-----------	----	---	---	---	----	-----

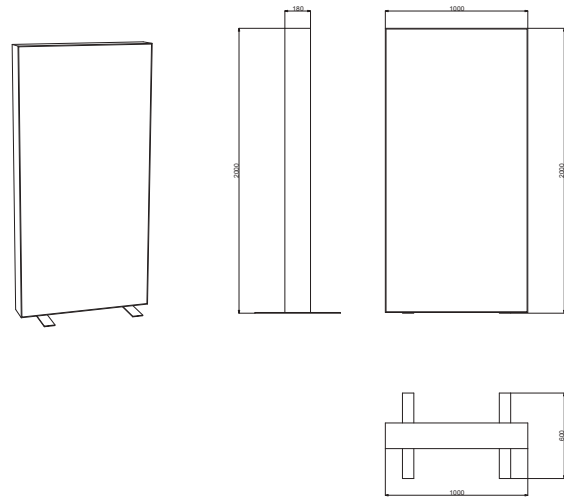

LIGHTBOX

SIZES : 200 x 100 x 18cm
 NO. CODE : 999-510-6004 (INCL. LED LIGHT SYSTEM/EU POWER PLUG 220V)

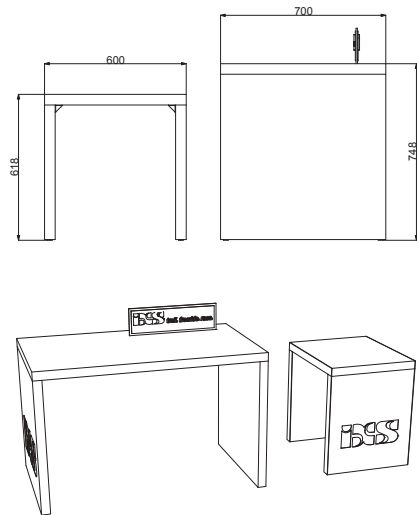

DECO-DESK

SIZES : 120 x 70 x 75cm
 NO. CODE : 999-510-6003

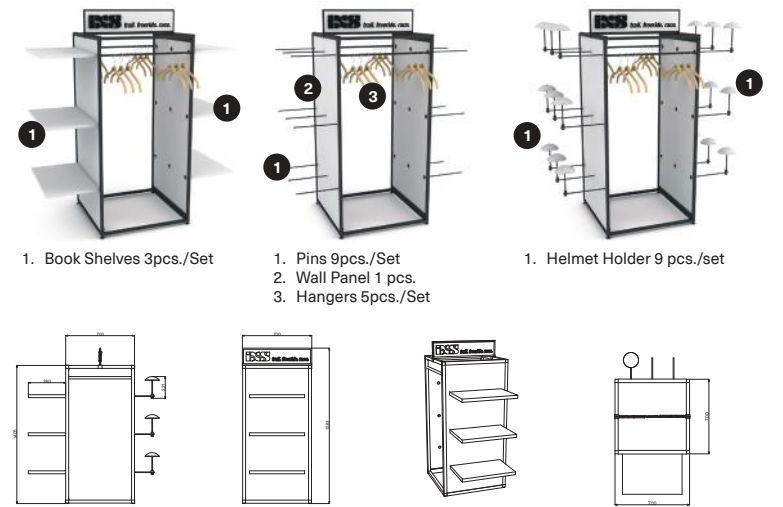

FIG. A

BASIC MODULE (FIG. A)

SIZES : 70 x 70 x 160cm
 NO. CODE : 999-510-6001

Accessories/Assembling options (not included):
 1pc. Wall Panel incl. 9 Pins 999-510-6001-1
 Book Shelves 3pcs./Set 999-510-6001-4
 Pins 9pcs./Set 999-510-6001-8



- 1. Book Shelves 3pcs./Set
- 1. Pins 9pcs./Set
- 2. Wall Panel 1 pcs.
- 3. Hangers 5pcs./Set
- 1. Helmet Holder 9 pcs./set



1. Hangers 5pcs./Set

SPIDER

SIZES : 100 x 100 x 160cm
 NO. CODE : 999-510-6002

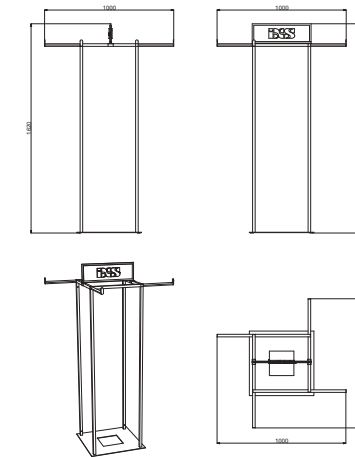

Accessories/Assembling options (not included):

- Shirt Hangers 5pcs. Set 473-510-3000-808
- Pant Hangers 5pcs. Set 473-510-3010-808



Logo stand
577-510-1100 (3pcs/pack)



Goggle slatwall display (5pcs/pack)
577-510-1120-003



Goggle slatwall display (5pcs/pack)
577-510-1125-003



Helmet slatwall display (5pcs/pack)
577-510-1110-003



Rail bar slatwall hook
577-510-1133-003



Straight bar slatwall hook
577-510-1131-003

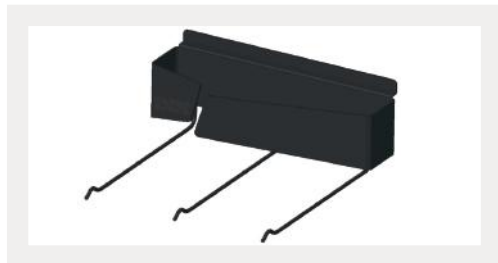

3-Peg slatwall hook (graphic applied)
577-510-1134-003



Waterfall slatwall hook
577-510-1130-003



Head display (helmets)
577-510-585



Arm display (gloves/elbow guards)
577-510-586



Leg display (knee guards)
577-510-587

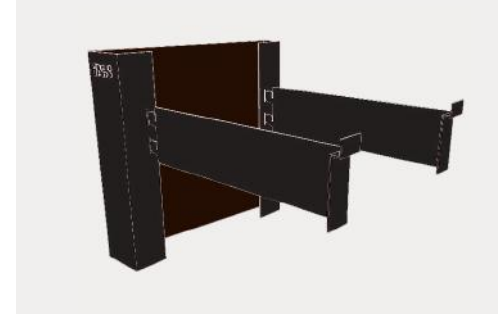

Graphic box slatwall display (graphic applied)
577-510-1135-003



Straight peg slatwall hook
577-510-1132-003



Hanger shirts 5pcs./pack
473-510-3000-808



Hanger shorts 5pcs./pack
473-510-3010-808



Foldable event tent 3x3m
999-510-1010

Side wall (3x3m tent)
999-510-1030



Barrier tape 500m rolled
577-510-3400



Banner 150x100cm
577-510-3500-004



Endless banner 18m
577-510-3600-004



X-Matter Promo Ball
482-510-3999-001



Key chain guardian angle
577-510-581

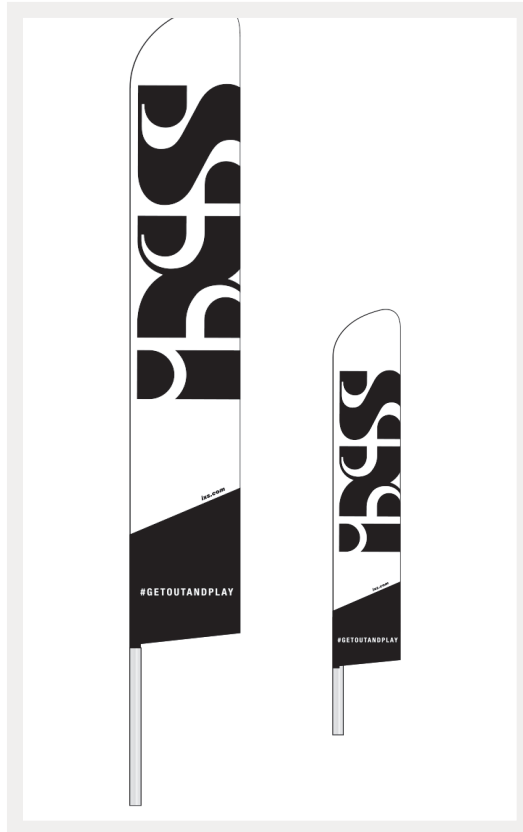

Beach flag 5.5m
577-510-800

Indoor Beach Flag 2.2m
577-510-800-2

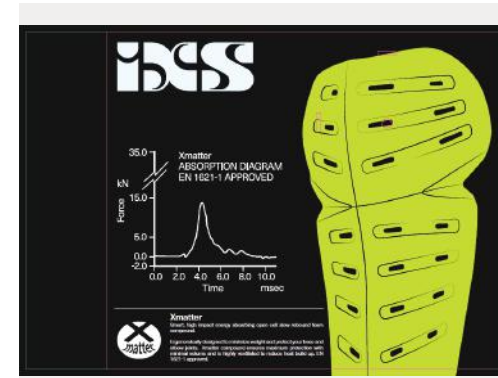

Visual for illustration purposes only.

X-Matter Tech Display
577-510-1230

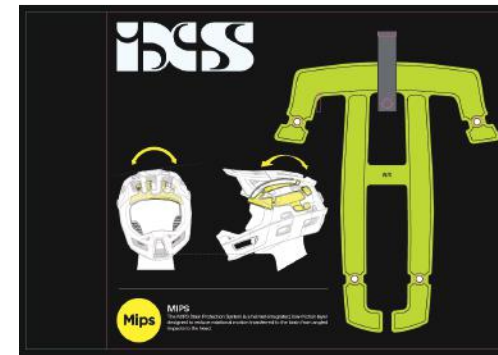

Visual for illustration purposes only.

Mips Tech Display
577-510-1231



A - Assorted Stickers 3 & 5cm (20pcs.) 577-510-590-2
B - Assorted Stickers 15 & 35cm (4pcs.) 577-510-590-3
C - Assorted Stickers 15cm (20pcs.) 577-510-590-5



PET Display (PET process)
577-510-600-41

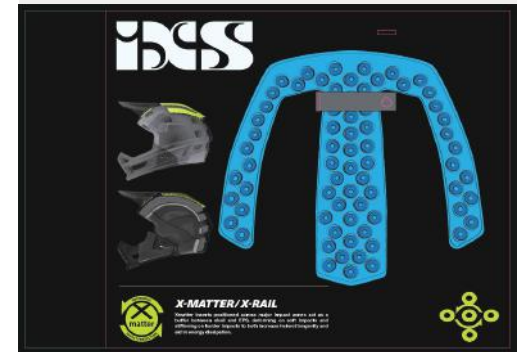

Visual for illustration purposes only.

X-Rail Tech Display
577-510-1232



Sample bag
577-510-1199-003

***LIVE
TRAIL
LIFE***