

BATTERY INSTALLATION GUIDE

Natural Gas Alarm: Model ML-310ES

DeNova Detect[®]
Smarter Gas Leak Safety

WARNING Battery not connected. See diagram to connect battery with wires. Natural Gas alarm will not operate unless battery is properly installed

DO NOT REMOVE the plastic surrounding the battery pack.

CONNECT BATTERIES by inserting battery harness plug into the Gas Alarm as shown.

WATCH for green Power light on front of Gas Alarm to blink for 30 seconds and then stop. **LISTEN** for one beep after green Power light stops to confirm Gas Alarm has completed power-on cycle.

TEST GAS ALARM. Press and hold the test button for 5 seconds. If the Gas Alarm is operating properly, the red light on the front of the Gas Alarm will blink once every 2 seconds for a 12 second period, and you will hear four beeps: *Beep Beep Beep Beep*, and a recorded message:

"Danger. Gas leak explosion risk. Evacuate, then call 911."

"Peligro. Riesgo de explosión por fuga de gas. Evacuar, luego llamar al 911."

NEVER
Remove the
plastic

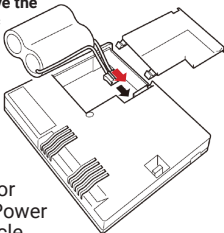

MOUNT GAS ALARM

in every room with a gas appliance—between 3 and 10 feet away from the gas appliance. Gas Alarms should be within 12 inches from the ceiling—where natural gas accumulates first.

CONSULT MODEL ML-310ES USER'S MANUAL

for complete instructions and important safety information.

**Natural Gas Alarm
ML-310ES**

User's Manual

Thank you for purchasing a DeNova Detect® Natural Gas Alarm. Please thoroughly read and understand this user manual before using this Alarm and retain for future reference. When methane (natural gas) is detected, an alarm will be activated. The alarm consists of a flashing red LED light, sounding of a warning alarm and a recorded message.

**⚠ DANGER: ASPHYXIATION & EXPLOSION
NATURAL GAS LEAK ALARM INDICATES
AN EMERGENCY SITUATION AND RISK OF
EXPLOSION**

- Leave building immediately, open doors and windows as you leave. Take others with you. If you are outside when you hear the alarm, leave the area immediately.
- Avoid creating any sparks.
- Find a phone AWAY FROM THE AREA and immediately call 911 and/or your gas utility.
- Do not re-enter the area until source of the leak is found and corrected.

Follow directions from utility employees or emergency responders on site.

⚠ DANGER: ELECTROCUTION

- Do not subject the Gas Alarm to water or liquid by submerging it, spraying liquid on it or otherwise.
- Do not disassemble.

⚠ DANGER: EXPLOSION

Do not use as a short-term testing device. Doing so may cause explosion.

⚠ DANGER: FIRE & EXPLOSION

Improper disposal may result in fire or explosion.

⚠ DANGER: HAZARDOUS CONDITIONS

Follow these instructions completely. Failure to do so may result in an undetected natural gas leak or other hazardous conditions that may cause serious injury or death.

⚠ DANGER: HEARING DAMAGE

Do not place ear directly against or in close proximity to Gas Alarm. Audio alarm may damage hearing.

⚠ WARNING

- Do not block, cover, obstruct or paint over sensor. The Gas Alarm can only detect natural gas that reaches its sensor.
- This Gas Alarm will reach the end-of-service life in approximately 6 years. Replace after end-of-service life signal is initiated.
- Test product regularly. Device must be turned on and connected to power at all times.
- Do not modify, disassemble, submerge, strike, crush, or expose Gas Alarm to high levels of volatile organic compounds. May cause Gas Alarm malfunction.
- Contact manufacturer for replacement battery. Commercially available batteries will not work.
- Keep out of reach of children.
- For indoor use only.

⚠ NOTICE

- Gas Alarm only detects natural gas. It does not detect carbon monoxide, fire, heat, smoke, flames, propane or any other gas.
- Gas Alarm is not a substitute for proper installation, use, and maintenance of natural gas sources. Gas alarm does not prevent natural gas leak from occurring, nor can it solve any existing natural gas problems.

General description & intended use

⚠ DANGER

If you smell natural gas, evacuate the area right away, then call 911 or your gas utility. Do not wait for alarm to sound.

⚠ DANGER

This Gas Alarm is designed to act as a continuous monitor of natural gas that reaches the sensor. This Gas Alarm should not be used as a short-term testing device to perform a onetime check for the presence of natural gas, as starting the device in the presence of natural gas may cause an explosion.

This Gas Alarm detects natural gas. Natural gas is a fossil fuel that is primarily made up of methane. It is commonly used for cooking, home heating and water heating. Natural gas is typically supplied through a main utility line connected to your home. It is a highly flammable chemical compound. Although it happens rarely, a natural gas leak can sometimes occur inside the home. This can be dangerous because it increases the risk of explosion and fire.

Natural gas is typically odorless and colorless, unless your supplier treats it with a chemical to make it smell. Individuals with diminished sense of smell may not be able to detect even treated natural gas. If you are not sure which gas your home uses, contact your utility company.

When this product detects natural gas at a concentration of greater than or equal to 10% LEL for methane, it is designed to beep 4 times and state "Danger - gas leak explosion risk - evacuate, then call 911" followed by 4 additional beeps and state "Peligro - riesgo de explosión por fuga de gas - evacuar, luego llamar al 911."

It is possible that you may smell natural gas before the alarm is activated. If you do smell natural gas, do not wait for the alarm to sound. Evacuate right away, then call 911.

This Gas Alarm is designed to act as a continuous monitor of natural gas that reaches the sensor. This Gas Alarm should not be used as a short-term testing device to perform a onetime check for the presence of natural gas, as starting the device in the presence of natural gas may cause an explosion.

Gas Alarm parts

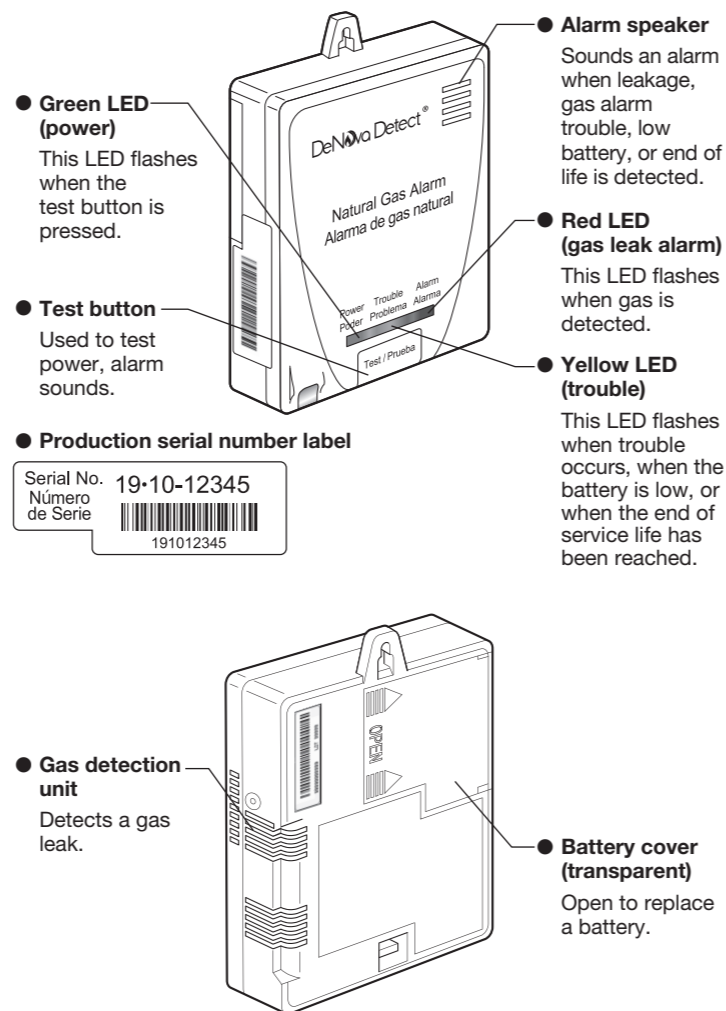

Installing the Gas Alarm

Selecting Gas Alarm location

⚠ WARNING

- Installation in an improper location can affect the sensitive electronic components in this device.
- Improper placement can prevent detection of natural gas.
- Improper placement can prevent you from hearing the alarm. Install in a location where you can hear the alarm sound loudly from all sleeping areas.
- Place out of reach of children. Under no circumstances should children be allowed to handle this device.

Gas Alarms should be installed in all rooms where a gas leak may occur or a gas appliance is located. Examples are a kitchen (gas leaks from gas ovens and cook tops), laundry (gas leaks from a gas clothes dryer), and furnace area (gas leaks from furnace burners or boilers).

It is possible that gas leaks may migrate along pipes so consideration should be given to place Gas Alarms in multiple rooms. Consider placing a Gas Alarm in each bedroom where the occupant closes the door while sleeping.

Although it is important to install Gas Alarms in rooms where gas appliances exist, it is recommended the Gas Alarm be placed as far from these appliances as possible, preferably more than 10 feet (3 meters) away. The placement recommendations are intended to keep these Gas Alarms at a reasonable distance from a gas source, and thus reduce "unwanted" alarms, which can occur if a Gas Alarm is placed directly next to a gas source.

Avoid placing the Gas Alarm near a cooking appliance or cooktop hood. If you must do so, install at least 5 feet (1.5 meters) from cooking appliance or cooktop hood because cooking vapors or grease may contaminate the Gas Alarm.

Product should be installed:

- Between 4 to 12 inches (0.1 to 0.3 meters) from the ceiling.
- In an area where it will not be impeded by items hanging from or near the ceiling such as curtains, drapes, ceiling fans.
- At least 5 feet (1.5 meters) from cooking appliance or cooktop hood.
- At least 10 feet (3 meters) from gas appliances.

Product should NOT be installed:

- In the peak of a cathedral ceiling.
- Directly above or near sources of water or humidity such as a sink, cooktop, dishwasher or shower.
- Next to a door or window.
- Next to a ventilation fan.
- Near a room return or HVAC duct.
- In an area where the temperature will drop below 32°F (0°C) or exceed 122°F (50°C).
- In an area that is dusty or dirty.
- In an area where organic solvents exist or silicone vapors exist.
- In a damp or very humid location, such as a bathroom.
- Outside.

Installing (or replacing) the battery

⚠ DANGER – SHOCK

Do NOT remove the plastic wrap surrounding the battery pack. Doing so may cause electrical short or shock.

⚠ WARNING

After installing or replacing battery, always test the Gas Alarm to ensure it is operational.

⚠ NOTICE

Device uses type of battery that is not available in retail. Contact manufacturer for replacement batteries.

To install the included battery or replace with manufacturer-supplied replacement:

- Open the battery cover on the back of the Gas Alarm. This cover slides out of place. To open, place both thumbs on the back of the battery cover where the battery cover hooks snap into place.
- Push down where the battery cover snaps into place with your thumbs and slide the cover out. Some force is required.

To remove the battery cover, push down at the indicated points with your thumbs and slide the cover in the direction of the arrow.

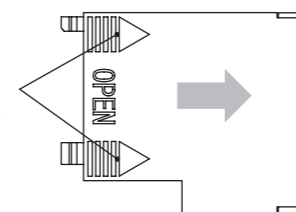

- Connect the included lithium battery by inserting the battery harness connector into the Gas Alarm as shown in the diagram below. Do NOT remove the plastic wrap surrounding the battery pack.

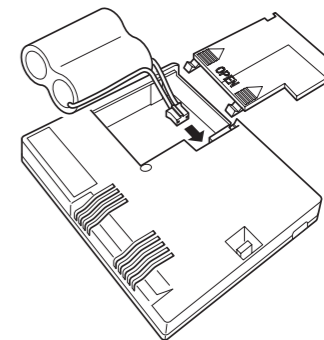

- The battery connector has a large notch on it that faces up when installed correctly. There is only one way in which the connector can be installed. A small portion of the connector will be exposed when connected properly.

If replacing battery, see "Disposal" section for instructions on disposing of the old battery.

Mounting the Gas Alarm

⚠ NOTICE

After mounting the Gas Alarm, test it following instructions in User's Manual.

The Gas Alarm may be mounted to a pipe or wall in a location meeting the criteria discussed in the "Selecting Gas Alarm location" section.

To mount to a pipe:

- (1) Pass a cable tie through the hole at the top of the Gas Alarm. Cable tie is not included with device purchase.

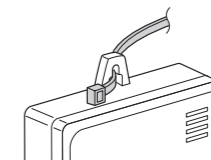

- (2) Wrap the cable tie around the pipe and tie off.

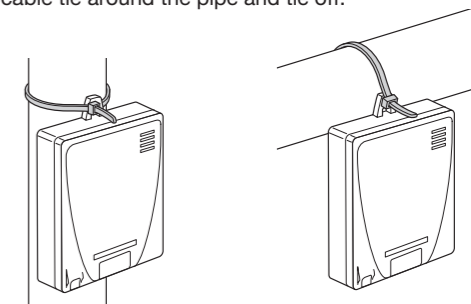

To mount the Gas Alarm to a wall:

- (1) Tools you will need: Drill with 3/16" or 5 mm drill bit, Phillips head screwdriver, hammer.
- (2) Tools supplied: A plastic screw anchor and screw have been provided in the box and can be found under the battery packaging.
- (3) Choose a location on the wall between 4 inches (0.1 meters) to 12 inches (0.3 meters) from the ceiling. Make a mark in the Mounting Tab of the Gas Alarm where you will drill the mounting hole.
- (4) Use a 3/16" (5 mm) drill bit to drill the mounting hole and insert included anchor.
- (5) Tighten the screw into the anchor until the screwhead is about 3/16" (5 mm) away from the wall, leaving enough space for the Mounting Tab.
- (6) Hang the Mounting Tab on the screw.

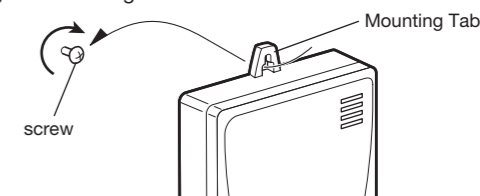

- (7) Lightly tighten the screw to secure the Gas Alarm.

Gas Alarm functions

The Gas Alarm is designed to activate an alarm in the event of a natural gas leak, Gas Alarm error, low battery or end-of-service-life for the Gas Alarm.

Natural gas leak alarm activation

An alarm activates when the concentration of natural gas in the area of the Gas Alarm reaches or exceeds 10%LEL for methane. When activated, alarm is designed to:

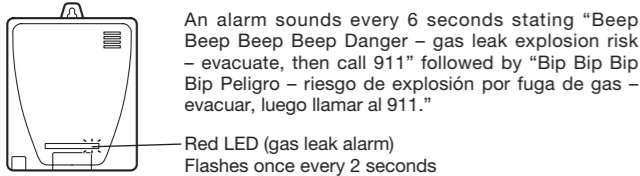

Beep 4 times and state “Danger – gas leak explosion risk – evacuate, then call 911” followed by 4 additional beeps and state “Peligro – riesgo de explosión por fuga de gas – evacuar, luego llamar al 911.” Notification will repeat every 6 seconds for 4 minutes, then every 1 minute after. Red LED flashes once every 2 seconds.

In the event that the natural gas leak dissipates to a concentration below the device’s alarm threshold, the gas alarm notification will automatically reset. The red LED will stop blinking, and the audible tone will stop.

Responding to natural gas leak alarm activation

⚠ DANGER– ASPHYXIATION & EXPLOSION

Follow these instructions carefully in the event that the gas leak alarm activates. Never ignore natural gas leak alarm.

When this product detects natural gas at a concentration of greater than or equal to 10% LEL for methane, it is designed to beep 4 times and state, “Danger – gas leak explosion risk – evacuate, then call 911” followed by 4 additional beeps and state “Peligro – riesgo de explosión por fuga de gas – evacuar, luego llamar al 911.” A red LED light will also flash on the product.

Leave the building immediately, opening doors and windows as you leave. Take others with you. If you are outside when you hear the alarm, leave the area immediately.

Any spark might cause natural gas to explode. Take all appropriate steps to avoid causing a spark near the affected property, including the following:

- **Do not remove the connector from the lithium battery.**
- **Do not light a match or smoke.**
- **Do not turn appliances or lights on or off.**
- **Do not use a flashlight or phone.**
- **Do not start a car.**

Find a phone away from the area and immediately call 911 and/or your natural gas utility. You can report leaks anonymously.

Do not re-enter the area until the source of the leak is found and corrected. Follow directions from utility employees or emergency responders who are on site.

⚠ DANGER: EXPLOSION RISK

Do not reset Gas Alarm after gas leak alarm goes off, unless instructed to do so by emergency personnel. Resetting process can cause an explosion if conducted in an area with high concentrations of natural gas.

Emergency responders or trained personnel may reset or instruct you to reset the Gas Alarm by removing and reinstalling the battery. This will turn off auditory and visual notifications. After removing the battery, hold the test button for at least 10 seconds and leave the battery unplugged for at least 2 minutes. This will reset the device by turning off auditory and visual notifications.

In the event that the natural gas leak dissipates to a concentration below the device’s alarm threshold, the gas alarm notification will automatically reset. The red LED will stop blinking, and the audible tone will stop.

Gas Alarm error activation

An alarm sounds every 60 seconds when a device error occurs, alternating between the following messages each minute: “Beep Beep Beep Detector error” and “Bip Bip Bip Error del detector.”

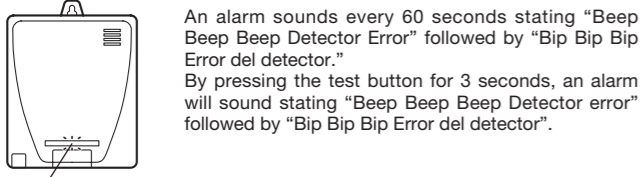

Yellow LED (trouble)
Flashes 3 times every 10 seconds

Yellow LED flashes 3 times every 10 seconds
See “Troubleshooting” section for more information on resolving device errors. See “Installing (or replacing) the battery” section.

Low battery alarm activation

⚠ WARNING

Gas Alarm uses specialized battery not available at retail. Contact DeNova Detect® for replacement.

An alarm sounds when the battery is low. When the low battery alarm first activates, the Gas Alarm will beep 1 time and state “low battery” followed by an additional beep and state “Batería baja”.

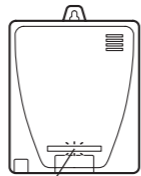

Yellow LED (trouble)
Flashes once every 10 seconds

Yellow LED flashes once every 10 seconds
Contact DeNova Detect® for replacement battery.

End of service life alarm activation

An alarm activates when the end of service life is reached. When the end of service life alarm first activates, the Gas Alarm will beep 2 times and state “Please Replace Detector” followed by 2 additional beeps and state “Por favor, reemplace el detector.”

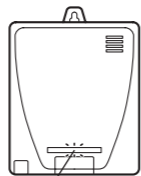

Yellow LED (trouble)
Flashes twice every 10 seconds

Yellow LED flashes 2 times every 10 seconds.

The audible end of service life alarm can be silenced by pressing the test button for 3 seconds and releasing. The Gas Alarm will beep twice and state “Please replace detector” followed by 2 additional beeps and state “Por favor reemplace el detector” after releasing the test button, at which point the end of service life alarm will be silenced for the next 8 hours. The yellow LED will still flash 2 times every 10 seconds during this time. After 8 hours, the audible end of service life alarm will re-activate. This audible alarm can be silenced for up to 30 days after its initial activation, at which point it can no longer be silenced.

Testing the Gas Alarm

⚠ CAUTION

Test your Gas Alarm’s power and gas leak alarm notifications at least once a week.

If the device does not operate properly it cannot alert you to the presence of natural gas. Take immediate action if your Gas Alarm fails a test.

Testing power

Press test button until you hear a “Beep” sound, then quickly release (within 3 seconds from when the button was pressed). If the device is properly powered, the green LED will flash twice every second (for 3 seconds) to indicate that the power is on.

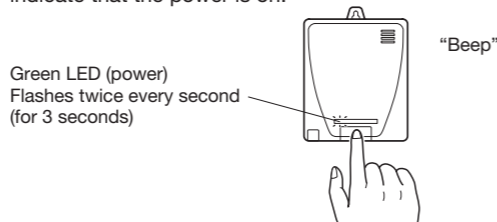

Testing gas leak alarm notifications

Press the test button for 5 seconds and the alarm notification test will begin automatically.

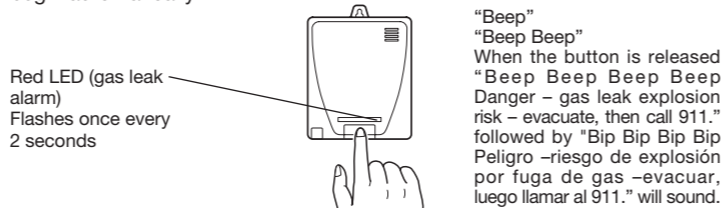

If the device is operating properly, the red LED will flash once every 2 seconds for a 12 second period, and the following alarm message will sound: “Beep Beep Beep Beep Danger – gas leak explosion risk – evacuate, then call 911. Bip Bip Bip Bip Peligro – riesgo de explosión por fuga de gas – evacuar, luego llamar al 911.”

Cleaning

⚠ WARNING

Clean the Gas Alarm in accordance with these instructions once a month. Dirt and dust can cause Gas Alarm malfunction.

After cleaning, always test the Gas Alarm to ensure it has not been damaged.

Clean at least once a month to maintain proper operation, by vacuuming the exterior of the Gas Alarm using a household vacuum’s soft brush attachment.

Never use water, cleaners or solvents since they may damage the unit.

Do not use spray cleaning chemicals or insect sprays directly on or near the device. Do not use any household cleaning agents, ammonia-based cleaners, paints, varnishes, aerosol sprays (including compressed gas dusters), or any other chemical on or near this device.

Troubleshooting

Symptom	Cause	Action
The green LED does not flash even when the button is pressed	Battery connector not plugged in	Plug in the battery connector
	Battery is low	Contact manufacturer for replacement
The yellow LED is flashing.	Flashes three times every 10 seconds: Gas alarm trouble	Replace Gas Alarm
	Flashes twice every 10 seconds: End of gas alarm service life	Replace Gas Alarm
	Flashes once every 10 seconds: Low gas alarm battery	Contact manufacturer for replacement

Disposal

⚠ DANGER

Prior to disposing of product, remove and wrap the removed battery with tape or similar material to avoid potential explosion or ignition that may result in injury or fire.

⚠ DANGER

Do not incinerate. Battery may explode.

When disposing of product, remove the battery and wrap with tape or similar, non-flammable material.

Dispose of battery in accordance with local regulations relating to non-rechargeable (single use) lithium batteries. Dispose of remainder of device following your local regulations for solid waste disposal. Take the device to an electronics recycling facility (where such facilities exist) for disposal.



Specifications

Model number	ML-310ES
Conforming standards	UL standard (UL1484)
Detection principle	MEMS hot wire semiconductor sensor
Target gas	Methane gas (Natural Gas)
Operating temperature range	32°F (0°C) to 122°F (50°C)
Operating humidity range	5% to 95%, no condensation
Power supply	3V Lithium battery
Alarm level	10% LEL*
Speaker output	Gas alarm: 85 dB at 10 feet
Product lifetime	Approximately 6 years
Dimensions	W 85 × H 100 × D 22 mm
Installation	Pipe mount by cable ties or wall mount with hardware.

* LEL, short for “Lower Explosive Limit”, is defined as the lowest concentration (by percentage) of a gas or vapor in air that is capable of producing a flash of fire in presence of an ignition source (arc, flame, heat).

Note: This equipment has been tested and found to comply with the limits for a Class B digital device, pursuant to Part 15 of the FCC Rules. These limits are designed to provide reasonable protection against harmful interference in a residential installation. This equipment generates, uses and can radiate radio frequency energy and, if not installed and used in accordance with the instructions, may cause harmful interference to radio communications. However, there is no guarantee that interference will not occur in a particular installation. If this equipment does cause harmful interference to radio or television reception, which can be determined by turning the equipment off and on, the user is encouraged to try to correct the interference by one or more of the following measures:

- Reorient or relocate the receiving antenna.
- Increase the separation between the equipment and receiver.
- Connect the equipment into an output on a circuit different from that to which the receiver is connected.
- Consult the dealer or an experienced radio/TV technician for help.

This device complies with part 15 of the FCC Rules. Operation is subject to the following two conditions:

- (1) This device may not cause interference.
- (2) This device must accept any interference, including interference that may cause undesired operation of the device.

FIVE YEAR LIMITED WARRANTY

Warranty Coverage: New Cosmos USA warrants that this product will be free of defects in material and workmanship for a period of five (5) years from date of purchase. This warranty does not apply to any batteries used in the product or to any damage which may be caused by such batteries. New Cosmos USA’s liability hereunder is limited to replacement of the product, repair of the product, or replacement of the product with a repaired product at the discretion of the manufacturer. For the avoidance of doubt, this warranty shall not be construed to provide for damages related to loss of use of this product or for any indirect, special, incidental, or consequential damages, or costs, or expenses incurred by the consumer or any other user of this product, whether due to a breach of contract, negligence, strict liability in tort or otherwise. This warranty is void if the product has been damaged by accident, unreasonable use, neglect, tampering, or other causes not arising from defects in material or workmanship. This warranty extends to the original consumer purchaser of the product only and may be enforced only by the original consumer purchaser. Proof of purchase may be required. This warranty is only valid for merchandise purchased from authorized distributors in the United States and Canada.

Warranty Disclaimers: New Cosmos USA specifically disclaims all implied warranties other than those described in the preceding paragraph to the maximum extent allowable by applicable law, and has provided for no express warranties beyond those covered in the preceding paragraph. To the extent any tribunal of competent jurisdiction applies any warranty arising out of this sale beyond those expressed in the preceding paragraph, including but not limited to the implied warranties of description, merchantability and fitness for a particular purpose, all such warranties are limited in duration to the above warranty period. Some states do not allow limitations on how long an implied warranty lasts, so the above limitation may not apply to you.

Returns Under Warranty: During the above warranty period, your product will be replaced with a comparable product if the defective product is returned in a postage paid package together with proof of purchase date to the following address: 650 Warrenville Rd, Suite 101, Lisle, IL 60532. Please include a note describing the problem when you return the device. The replacement product will be in warranty for the remainder of the original device’s warranty period or for six months, whichever is longer. Other than the cost of postage, no charge will be made for replacement of the defective product. In many cases the quickest way to exchange your detector is to return it to the original place of purchase. If you have questions, call New Cosmos USA customer service department at 847-749-3064 or email us at support@newcosmosusa.com.

Lithium Battery Excluded From Warranty. New Cosmos USA makes no warranty, express or implied, written or oral, including that of merchantability or fitness for any particular purpose, with respect to the included battery.

The above warranty may not be altered except in writing signed by both parties hereto.

Supplier's Declaration of Conformity 47 CFR § 2.1077 Compliance Information

Unique Identifier: ML-310ES

New Cosmos USA, Inc.
650 Warrenville Rd. Suite 101
Lisle, IL
60532
847-749-3064

Licenses:

"Denova Detect" and "Denova Detect" logo are registered trademarks in Japan and the United States.

Contact Details

New Cosmos USA, Inc.
650 Warrenville Rd, Suite 101
Lisle, IL, 60532
Phone: (847) – 749 – 3064