

Whats in the box

Your box should contain the following parts:

- 1 x Front Panel
- 1 x Rear Box
- 1 x Accessories pack

Choosing a suitable location

Letterbox can be mounted into a timber fence, a brick or a block wall.

You will need to install it in a location that is easily accessible to Couriers

Tools Required:

- Drill
- Timber Drill Bits
- Jigsaw
- Tape Measure

Disassembling the Front Panel for Installation

Begin by unscrewing the 4 mounting nuts to detach the front panel.

1. Open the front parcel door.
2. Open the rear door and unscrew the 2 mounting nuts.
3. Access the 2 top mounting nuts through the front parcel door.
4. Carefully pull the front panel to detach it from the back box.

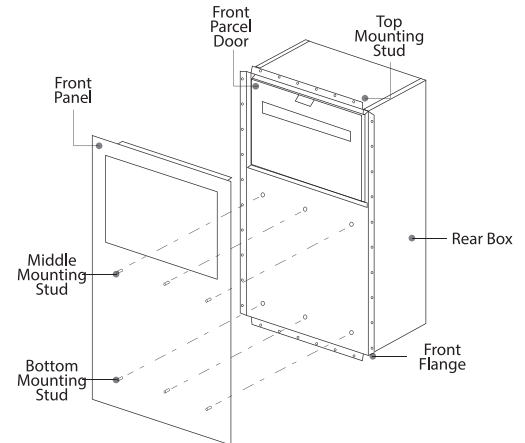

Installing on a Timber Fence

1. Measure the dimensions of the back box, then mark and cut a slightly larger hole in the fence using a jigsaw.

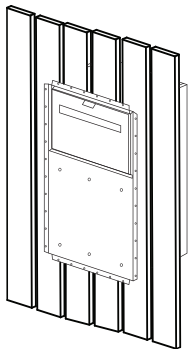
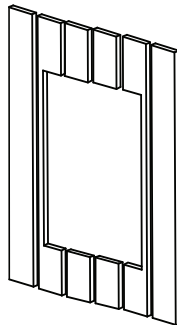

2. Slide the back box through the front side of the fence. Use the provided screws to securely attach it to the fence. For hardwood fences, it's recommended to pre-drill the screw holes for easier installation.

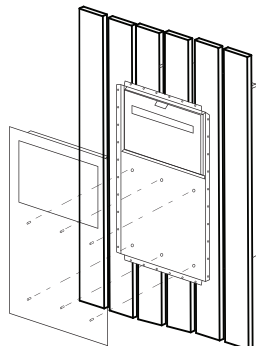

3. Attach the front panel by aligning the 6 mounting studs with the corresponding holes in the back box. Reach through the back door and fasten the panel using the provided nuts.

Secure the 2 top mounting nuts by reaching through the front parcel door.

Installation on a Brick Fence

1. Construct the brickwork up to the desired level and position the back box in place:
For plain brick walls, ensure the front edges are flush with the wall.
In the case of rendered walls, position the back box slightly forward to accommodate the render thickness.

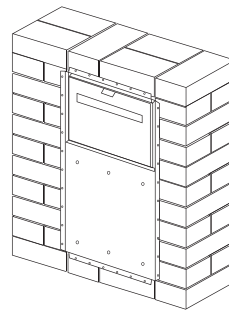
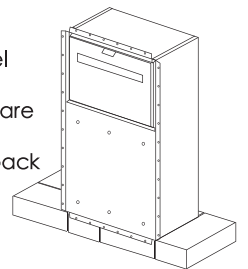

2. Continue building the remaining brickwork around the letterbox.

3. Once the brickwork and any rendering are completed, follow these steps to attach the front panel:

Insert the 6 mounting studs of the front panel through the corresponding holes in the back box.

Access the back door and fasten the panel securely using the provided nuts. Reach through the front parcel door and secure the 2 top mounting nuts.

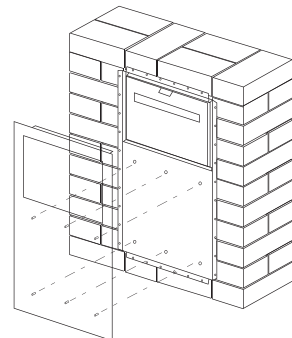

Using the Apex Parcel Letterbox:

The Apex mail + parcel letterbox is uniquely designed for convenient mail and parcel delivery. Mail and parcels measuring up to 28x14x24 cm can be delivered through the front door. The process involves the courier pulling open the front door, inserting the parcel inside, and subsequently closing the door. Upon closure, the parcel will safely descend into the retrieval area located at the bottom. An intricately designed internal mechanism prevents access to the retrieval area whenever the chute is opened.