

# KBAS121600 12V 160Ah



The Kaise Solar Range is mainly used in renewable energy applications, due to its optimal cyclic use performance. It is specially designed for frequent cyclic charge and discharging, providing superior high integrity and reliability. By using strong grids, thick plate and specially active material are designed for repeated deep-discharge applications. Kaise Solar Range offer approx. 30% more cyclic life than the Standard Series.



## Performance Characteristics

Nominal Voltage	12V	
Dimensions	Length (mm / inch)	340±2 / 13.4
	Width (mm / inch)	173±2 / 6.81
	Height (mm / inch)	280±2 / 11.0
	Total Height (mm / inch)	287±2 / 11.3
Approx. Weight	(Kg / lbs) 39.0 / 85.9	
Design Life	12 years (floating charge)	
Terminal	M8	
Container Material	A.B.S. UL94-HB, UL94-V0 Optional.	
Rated Capacity	156.1 Ah / 1.561 A	100hr, 1.60V/c, 25°C / 77°F)
	128.9 Ah / 12.89 A	(10hr, 1.75V/c, 25°C / 77°F)
	78.61 Ah / 78.61 A	(1hr, 1.65V/c, 25°C / 77°F)
Max. Discharge Current	1340A (5s)	
Internal Resistance	Approx 4.4mΩ	
Operating Temp. Range	Discharge : -20 ~ 60°C	
	Charge : 0 ~ 50°C	
	Storage : -20 ~ 60°C	
Nominal Operating Temp. Range	25°C ± 5°C	
Cycle Use	Voltage: 14.6V ~ 14.8V at 25°C (77°F)	
	Temp. Compensation: -4mV/°C / Cell	
Float Voltage Use	Voltage: 13.6V ~ 13.8V at 25°C (77°F)	
	Temp. Compensation: -3mV/°C / Cell	
Capacity affected by Temperature	40°C (104°F)	103%
	25°C (77°F)	100%
	0°C (32°F)	86%
Self Discharge	Fully charged Kaise Solar Series batteries may be stored for up to 6 months at 25°C (77°F) and then a freshening charge is required. For higher temperatures the time interval will be shorter.	

## Constant Current Discharge (Amperes) at 25°C (77°F)

Volts/cell	1h	3h	4h	8h	10h	24h	100h
1.80V	70.42	33.50	26.45	15.27	12.76	5.610	1.487
1.75V	73.70	34.14	27.08	15.52	12.89	5.666	1.502
1.70V	76.09	35.05	27.84	15.78	13.02	5.722	1.516
1.65V	78.61	36.59	28.73	16.03	13.27	5.834	1.546
1.60V	81.38	37.75	29.61	16.16	13.40	5.890	1.561

## Dimensions and Terminal (Unit: mm (inches))

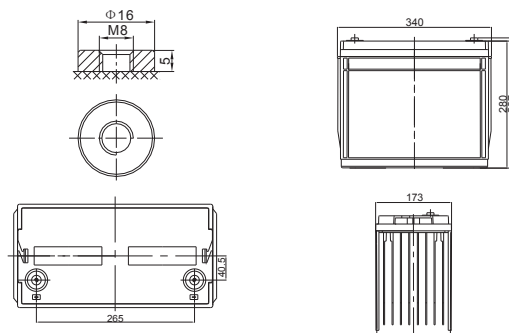

## Applications

- Renewable Energy
- Pump Systems
- Traffic lights
- Street lightening
- Marine equipment
- Caravans & Boats
- Weekend cottage camping
- Telecommunications systems

## Certifications

ISO 9001:2008 ISO 14001:2008



## Discharge Current vs. Discharge Voltage

Final discharge voltage V/CELL	1.8	1.75	1.7	1.6
Discharge current (A)	I ≤ 0.1CA	0.25CA ≥ I > 0.1CA	0.55CA ≥ I > 0.25CA	I > 0.55CA

## Constant Power Discharge (Watts per cell) at 25°C (77°F)

Volts/cell	1h	3h	4h	8h	10h	24h	100h
1.80V	135.94	65.20	51.63	29.85	25.02	11.00	2.914
1.75V	141.73	65.56	52.65	30.35	25.27	11.11	2.944
1.70V	145.70	67.22	53.91	30.86	25.52	11.22	2.973
1.65V	150.17	69.90	55.68	31.24	26.03	11.44	3.032
1.60V	152.79	71.69	57.08	31.49	26.28	11.55	3.062

(Note) The above characteristics data are average values obtained within three charge/discharge cycles not the minimum values.

## Discharge Characteristics Curve

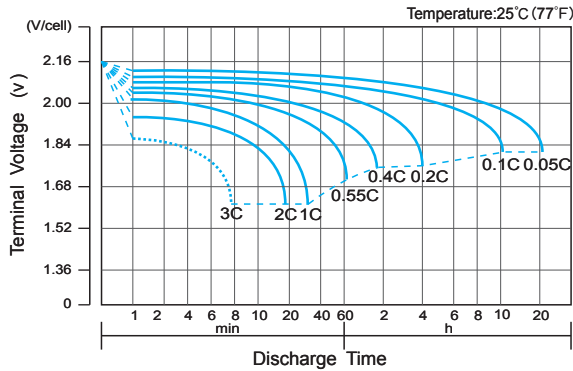

## Charge Characteristic Curve for Cycle Use (IU)

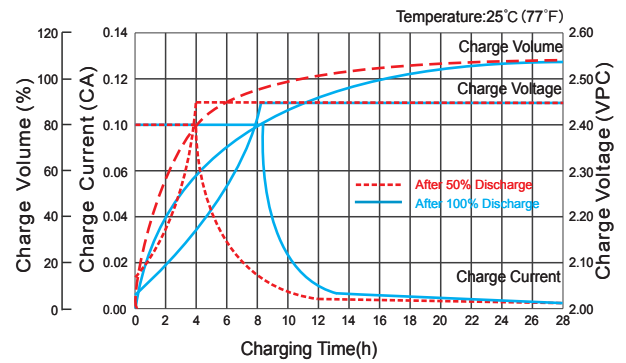

## Cycle Life in Relation to Depth of Discharge

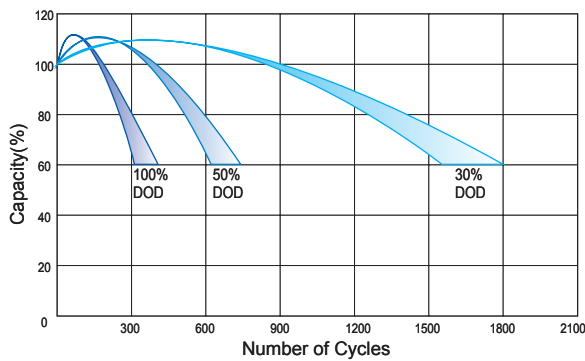

## Relation between Charging Voltage and Temperature

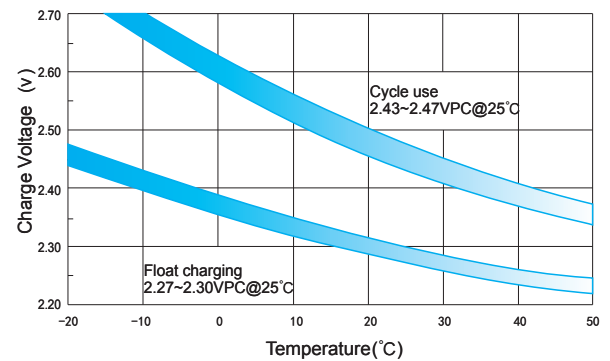

## Temperature Effects on Capacity

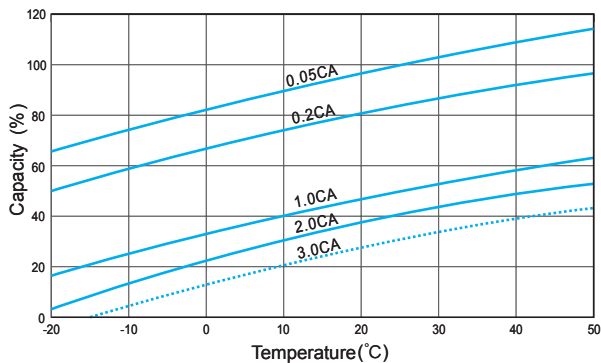

## Storage Characteristics

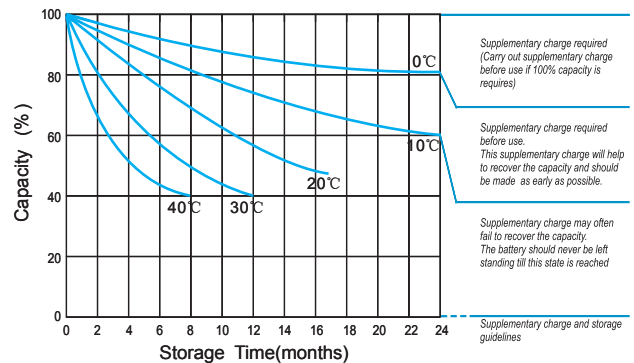

## Effect of Temperature on Long Term Life

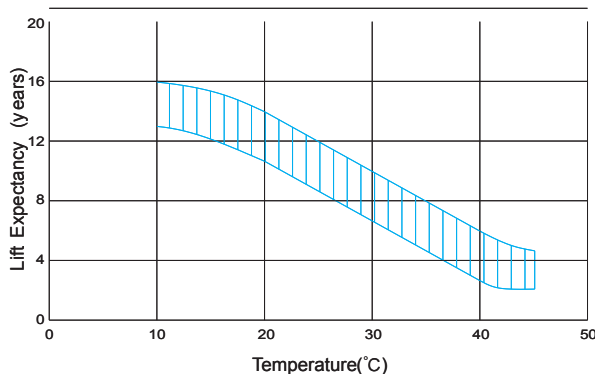

## Relation between OCV and State of Charge (20°C)

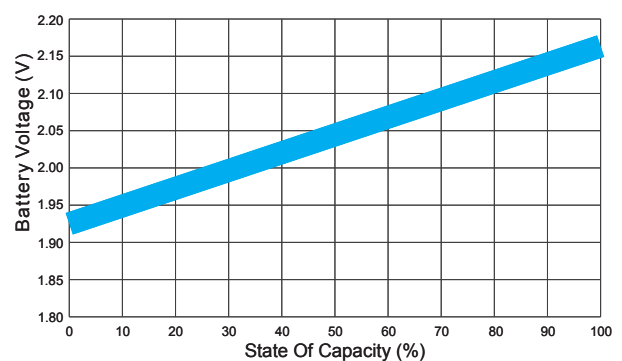

IMPORTANT NOTE: The specifications presented herein are subject to revision without notice.

