

LÈLIOR

DE PARIS

INSTRUCTION

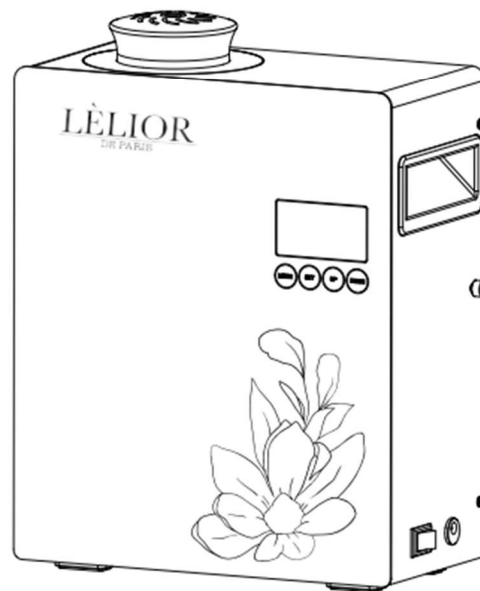

IL1000 Scent Diffuser User Manual

Product introduction

IL1000 diffuser system adopts two-fluid atomization technology. It is a fragrance diffuser in the area, and has a built-in intelligent PCB control program. The products can be placed independently, wall-mounted installation, can also be connected to the central fresh air conditioning system. The appearance of the product is stylish and atmospheric, and the fragrance is accurate and stable. Its main function is to create a different fragrance for life. It is suitable for hotels, airports, office buildings, cinemas, high-end shopping malls, entertainment clubs and other places.

In order to meet the demands of different customers, we have matched the following three types of device:

1. WiFi version: Connect to WiFi through the mobile phone APP and the device to control the working state of the device under the same network without people.
2. Bluetooth version: Connect the device Bluetooth through the mobile APP to control the working status of the device.
3. Ordinary version: Manually control the working state of the equipment through the touch panel.

Attentions

Please read this manual in detail before using the device and keep it carefully.

1. Please do not use overloaded power sockets, broken wire and adapter. It may endanger your safety and cause a fire, please replace in time if it happens.
2. Please do not try to modify, disassemble or repair the device in order to avoid damage to the device, if you are not a technician. If the device is abnormal, please check whether it is operated normally according to the user manual, or check according to the Malfunction Debugging. If it cannot be solved, please contact seller timely.
3. Please do not invert or tilt the device when used. If the device needs to be transported to other sites, please maintain and clean the device (see Maintenance for details) first before package and transportation, in case of oil leakage to damage the device.
4. Please maintain and clean the device regularly to ensure the device in best working states.

Instruction of Essential oil







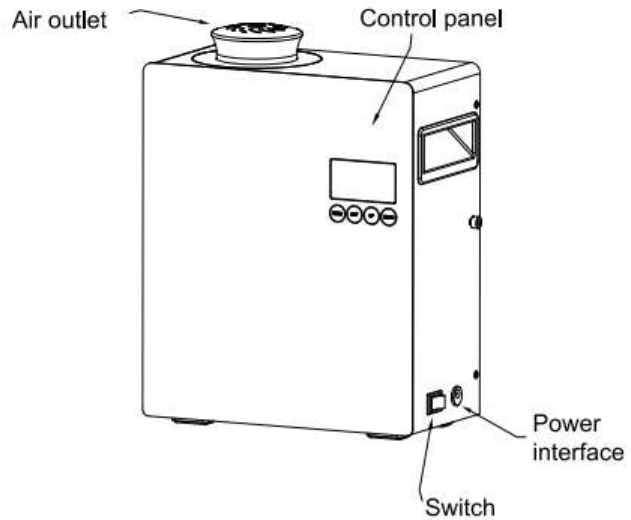

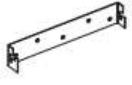

1. Before refill canister with essential oil, please turn off the device for 2 minutes till oil of atomizer back to canister then take off the oil canister.
2. It's recommended to control the amount of essential oil and run out within 45 days, in order to avoid the deterioration of essential oils by oxidation.

Parameters

Model	IL1000
Size	W220*D112*H292(mm)
Capacity	500ml
N.W	3.9KG
Coverage	2000 sqft
Voltage	DC12V-1A
Power	5W
Noise	≤46db
Package	W270*D210*H390(mm)



Accessories

Item	Power adapter	Key	Hanging panel	User manual	Atomizer core	PE seal ring	Screw/Expansion Nail
Diagram							
Name	Hexagonal wrench	HVAC connector	Pipe				
Thumbnail							

Installation

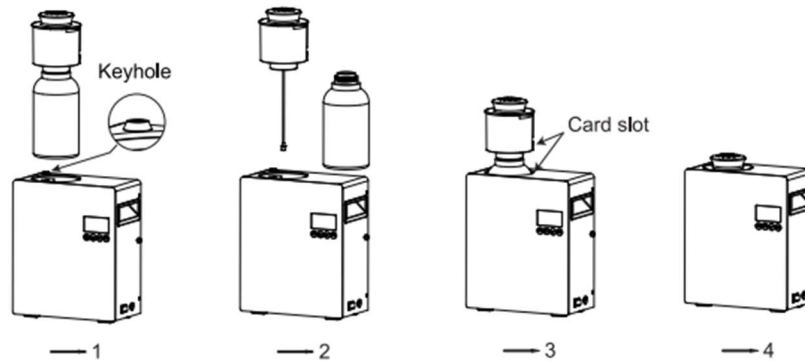

1. Insert the key to unlock the door, then pull up the atomizer head and take out the essential oil bottle.
2. Fill the canister with essential oil and put the canister back into the atomizer head.
3. Put the atomizer head and align the card slot, lock the atomizer head.
4. Connect the power and turn on the power switch, set the working time, device to start working.

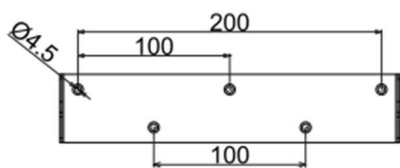

(Dimension of punching (mm))

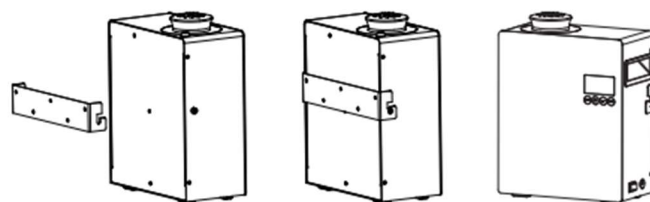

(Diagram of Wall-mounted Installation)

Description of LCD display

1. Button description:

- ① Mode: Switch the working mode.
- ② Set: Set the mode, set the time, move the cursor, press and hold for 5 seconds in the standby interface to restore the factory settings.
- ③ Up: Increase in time and concentration, select/invert the working day.
- ④ Down: Decrease in time and concentration, move to the left when setting the working day, long press to delete the mode.



2. Time setting:

- ① In the main interface state, press Set to enter the week/time setting.
- ② Set moves the cursor in sequence from week, hour, and minute.
- ③ Press Up/Down to move the cursor left and right to select the week.
- ④ Press Up to increase the hour/minute, and press Down to decrease the hour/minute.
- ⑤ Press Set again to confirm and return to the main interface, the setting is complete.

3. Working mode setting:

- ① Press Mode to enter the mode interface, in the mode that needs to be modified, press Set to enter the setting.
- ② Set moves the cursor from working day, start time, end time, and concentration in sequence.
- ③ When selecting the working day, press Up to select/invert the working day, and press Down to move the cursor one space to the left.
- ④ Up/Down set the start/end time, increase or decrease of concentration.

Tips

- ① The motherboard defaults to a 24-hour system and cannot be set across days, that is, the end time cannot be less than the start time. After the start working time is set, the end time can only be adjusted backwards. If the end time cannot be less than the start time, the next step cannot be set, and need to readjust the running time.
- ② Press Mode to exit the current mode setting and save it directly during any operation.
- ③ Ten seconds of no operation will automatically return to the main interface without saving any settings.
- ④ The working day in the factory mode defaults to the selected state from Monday to Sunday.
- ⑤ When selecting the working day, the cursor is first on Saturday.
- ⑥ The device displays the initial (local time) interface, press and hold the SET key for 10 seconds to restore the initial settings: the first running time period defaults from Monday to Sunday, starting time is 08:00, ending time is 22:00, and working time is 60 seconds, the pause time is 60 seconds. There is no setting for the 2/3/4 running time period.
- ⑦ Press and hold [UP] and [DOWN] at the same time for 10 seconds, the keys will be locked, a lock icon will appear, and the parameters cannot be modified at this time. Press and hold again 10 seconds to unlock, key function restore.

Maintenance

In order to ensure the best diffusing effect, please check and maintain the device every six month, or when you replace a new fragrance, or when the diffusing effect get weak as the following steps.

1. Take off the oil canister which is spent.
2. Filling industrial alcohol into the canister and clean it.
3. After clean the oil canister, refill canister with little alcohol and install it on the device then make the device stay in working status for 5-8 minutes.
4. Turn off the power when finishing cleaning.

Malfunction Debugging

Please try to solve the problem as below before fixing the machine.

Break down	Solution	Break down	Solution
Not working	<ul style="list-style-type: none">- Check if power adapter is DC12V-1A, and check if DC power interface is well-connected or not.- Check if device is not in work period.	Oil leakage	<ul style="list-style-type: none">- Check if canister connects to atomizer closely.- Check if seal ring is deformed or damaged.- Check if atomizer is damaged.
No mist Mist gets weak	<ul style="list-style-type: none">- Check if pump works or not, and if airflow from air outlet.- Check if atomizer core and oil tube are loose or blocked.- Check if seal ring gets damaged or fall off.	Abnormal noise	<ul style="list-style-type: none">- Check if air pump is loose, please fix it correctly.- Check if air pump is damage, please replace a new one.

After-sales Service

The warranty is 1 year from the date of sale, not including device shell, adapter, electric wires, seal ring and the other vulnerable parts, as well as the damage caused by human or accident. Permanent maintaining for value will be provided if the machine exceed the warranty.

If there is any issue of after-sales, please contact authorized sales service in corresponding area, or contact Sales Center directly.

Warranty Card

This card is the warranty for device's quality, please fill it with actual information.

Warranty card one		Warranty card two	
Start Date of Warranty Period		Start Date of Warranty Period	
Malfunction Description		Malfunction Description	
Date of Verify		Date of Verify	
Maintenance Result		Maintenance Result	
Maintainer's Signature		Maintainer's Signature	

LÈLIOR
DE PARIS

MANUFACTURED BY:
LÈLIOR GROUP LLC
1226 NW 23RD AVE FORT LAUDERDALE, FL 33311
INFO@LELIOR.COM



FOR MORE INFORMATION