

CONTENT & INSTRUCTIONS

THREAD YOUR BENCH 04

Follow steps 1-25 of the manual

MAKE A KNOT 14

Follow steps 26-31 of the manual

SHARING IS CARING 18

GUARANTEE & RETURNS 19

PACKAGE CONTENT FOR BENCH WITH 6 ELEMENTS

ASSEMBLY INSTRUCTIONS
6X BENCH PARTS
10X 88CM 4MM ROPE
4X 36CM 4MM ROPE
18X FELT PADS



FIND VIDEO TUTORIALS ON:
WWW.MOWO.STUDIO/PAGES/ASSEMBLY
OR SIMPLY SCAN THE QR-CODE

THREAD YOUR BENCH

STEP 1

Let's start by assembling two parts of your bench.

Place them next to each other on flat ground and pull the cord through the hole in the back of part 1.

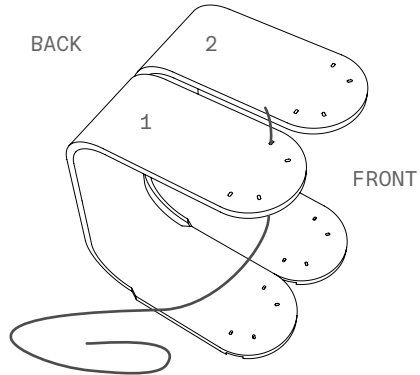

STEP 2

Thread it downwards through the front hole of the same part.

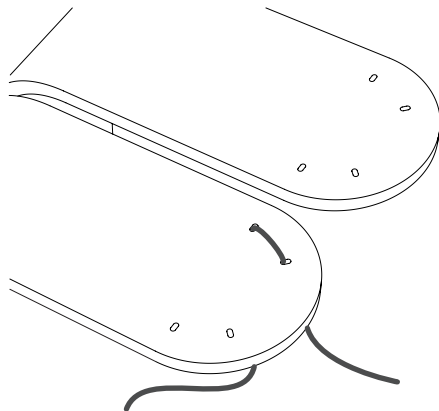

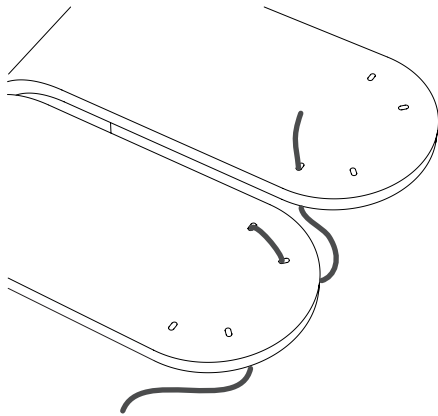

STEP 3

Now pull the cord up through the back hole of part 2.

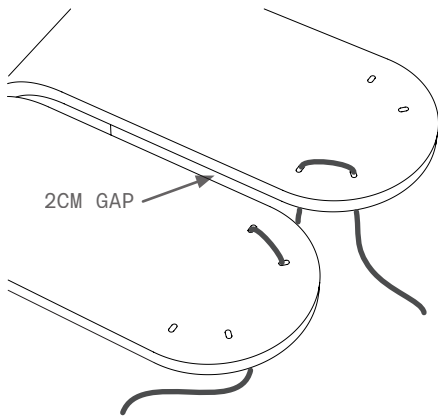

STEP 4

And thread it through the front hole of the same part. Don't pull the cords too tight to keep the intended 2cm gap between the parts.

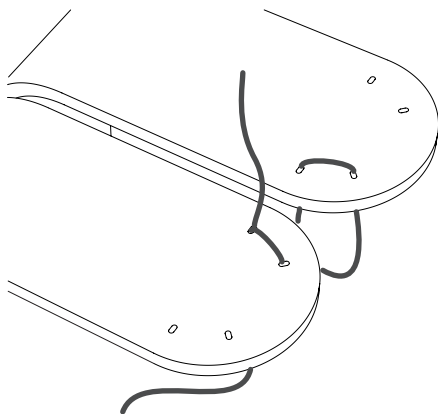

STEP 5

Now we repeat the last 4 steps to create a double line pattern.

Pull the cord through the hole in the back of part 1. The hole is big enough to accommodate two cords.

STEP 6

Thread it downwards through the front hole of the same part.

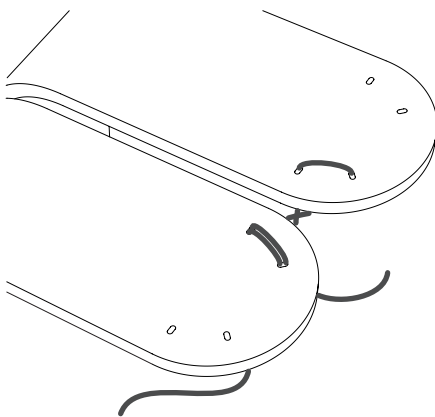

STEP 7

Pull the cord up through the back hole of part 2.

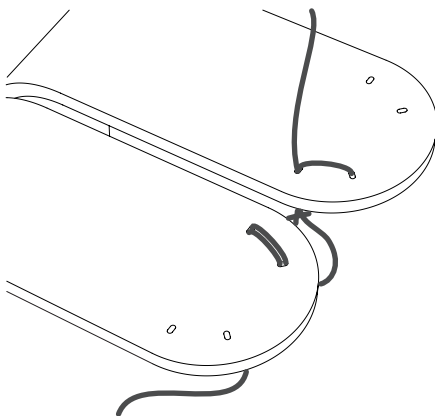

STEP 8

And thread it through the front hole of the same part.

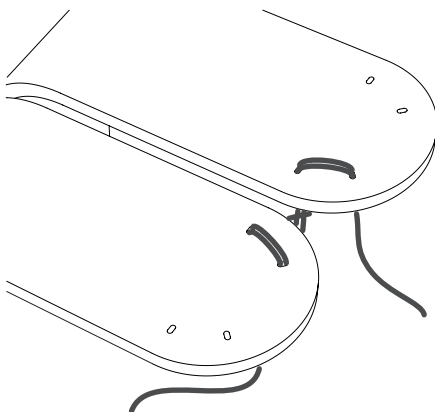

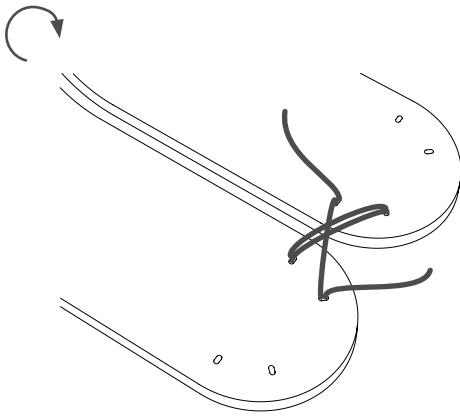

STEP 9

If you turn the stool around, this is what it should look like on the underside.

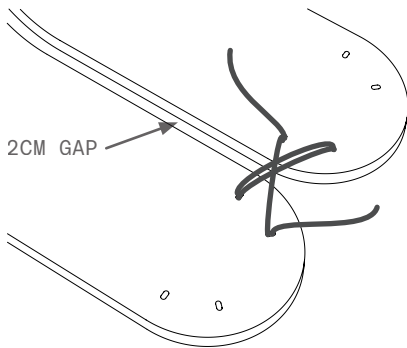

STEP 10

Check if the cord sits tight. Wherever it's loose, tighten it but make sure, to leave the gap between the parts as we want them to move independently later ;).

To make the knot jump to page 14.

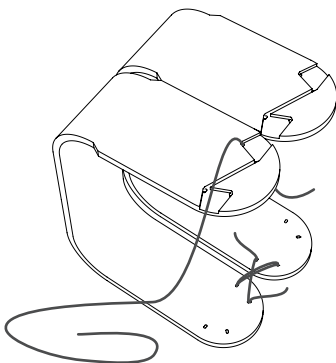

STEP 11

Let's continue with the foot part. The two parts are still upside down. Thread the cord downwards through the back hole of part 1.

STEP 12

Pull the cord up between the two parts.

We use a different pattern here, which ties the parts closer together for less movement.

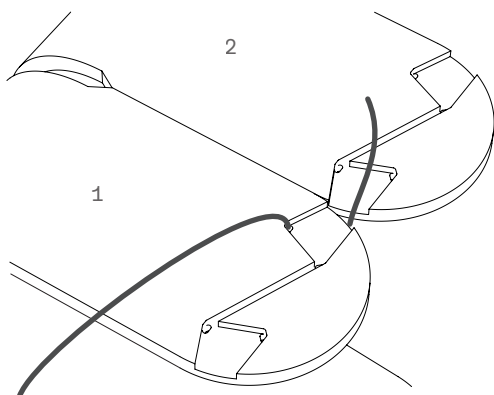

STEP 13

Thread it downwards through the front hole of part 2.

For better understanding, we're showing the previous threads in grey and the current one in black

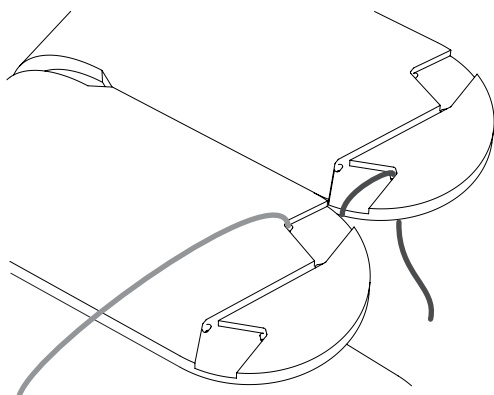

STEP 14

Pull it upwards through the back hole of the same part.

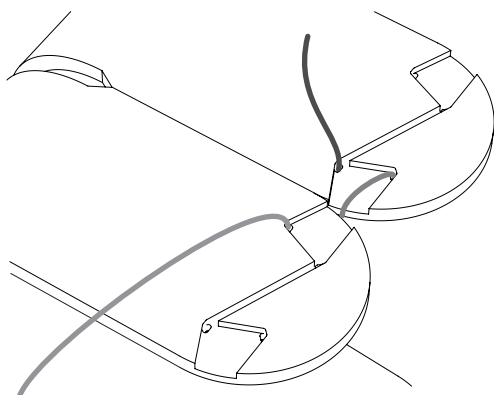

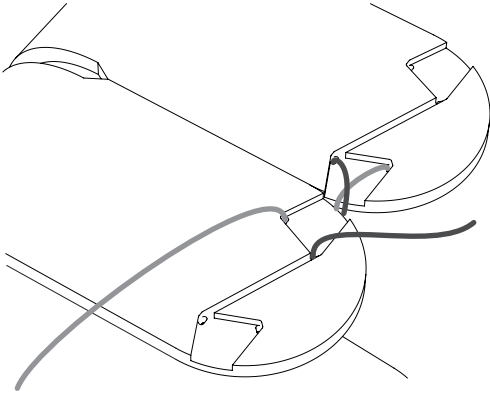

STEP 15

Thread the cord downwards between the parts and pull it upwards through the front hole of part 1.

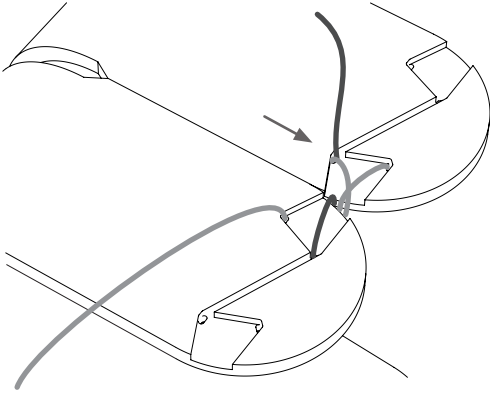

STEP 16

Again, we're going downwards between the two parts, then threading the cord upwards through the back hole of part 2.

The hole is big enough to accommodate two cords.

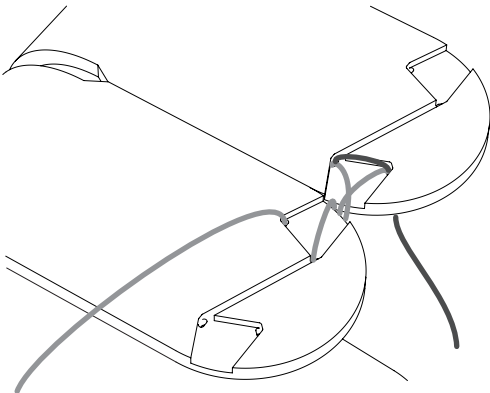

STEP 17

From here, you go to the front hole of the same part and thread the cord downwards.

STEP 18

Now go up between the parts and downwards through the back hole of part 1.

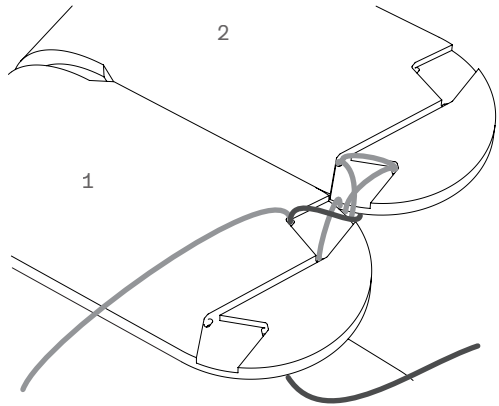

STEP 19

At last, you thread the end of the cord upwards, through the front hole of the same part. Pull the cords tight – the two parts should meet gaplessly this time.

To make the knot jump to page 14.

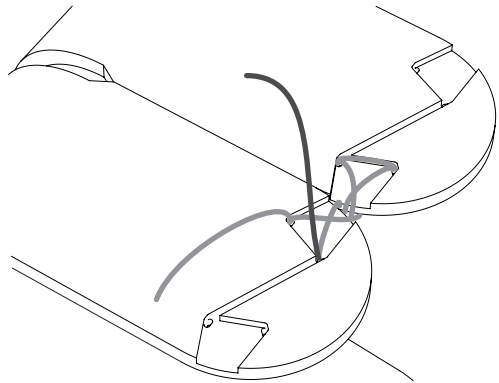

STEP 20

When you turn the two parts around, it should look like this.

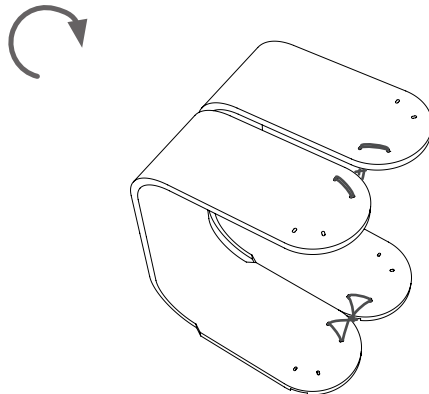

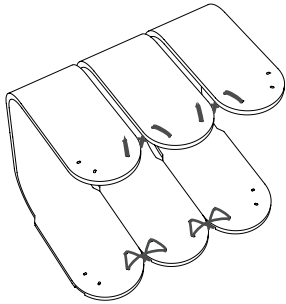

STEP 21

Now add the remaining pieces of your bench by repeating the same thread pattern.

Jump to [page 4](#) for the top pattern, to [page 7](#) for the bottom pattern.

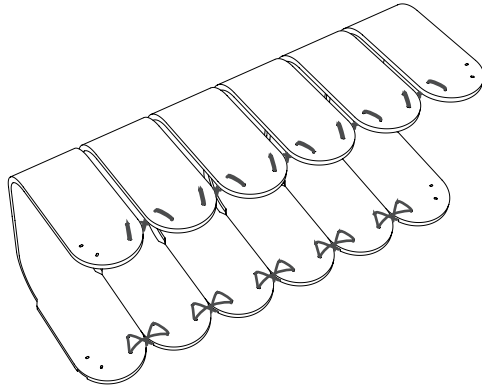

STEP 22

Once you've added all your elements your bench is ready for the final details.

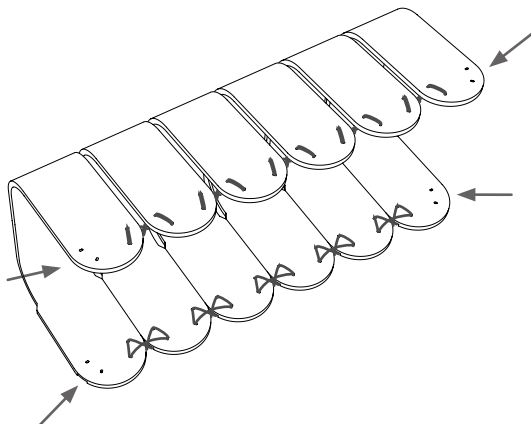

STEP 23

Let's thread some cords through these last empty holes, shall we?

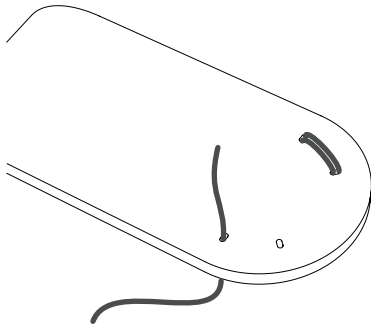

STEP 21

These last cords are just decorative, so have fun with them. Below is our suggestion on how to thread them, but you might wanna get creative ;).

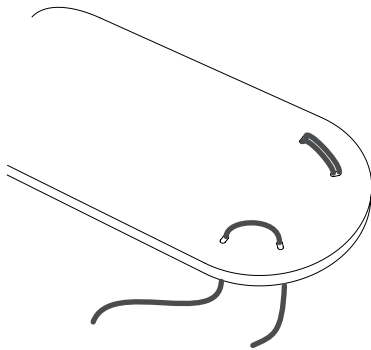

STEP 22

We make a double loup through the each set of holes.

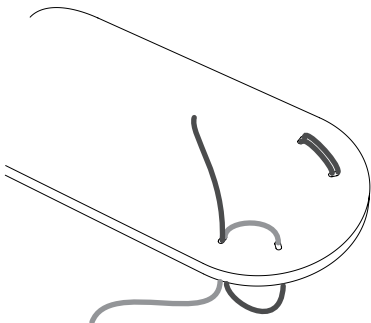

STEP 23

STEP 24

That's it. Repeat steps 21-24 for the three other ends of your bench.

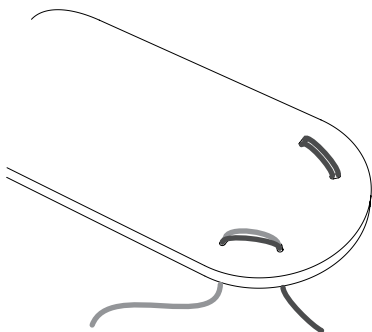

STEP 25

The loose cord ends should be on the underside, as we want to hide the knots.

Now, tie the remaining knots following the steps on the next pages.

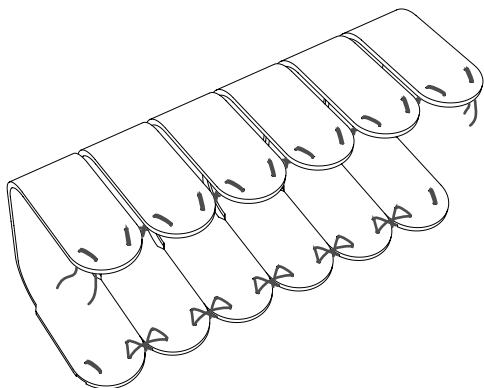

MAKE A KNOT

SQUARE KNOT

MOST OF YOU WILL KNOW THIS KNOT AS IT IS COMMONLY USED. HOWEVER, THE SECOND LOOP MIGHT BE DIFFERENT TO WHAT YOU ARE USED TO, SO TAKE A CLOSE LOOK.

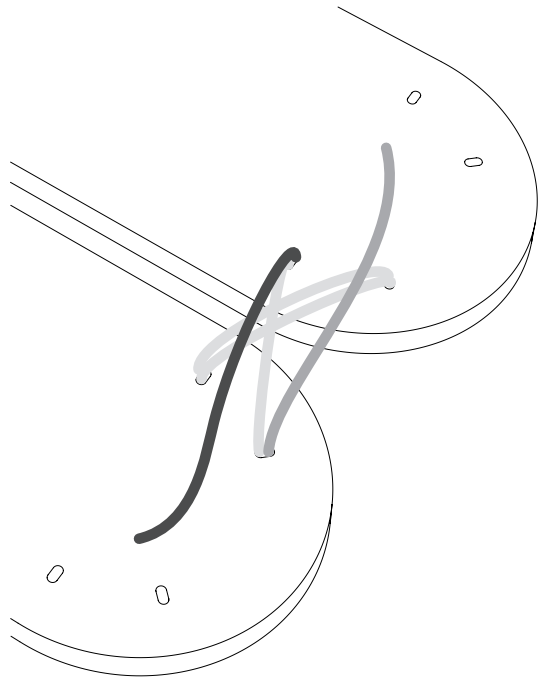



For better understanding we're showing the two cord ends in different shades.

STEP 26

Let's start!



STEP 27



STEP 28



STEP 29



STEP 30



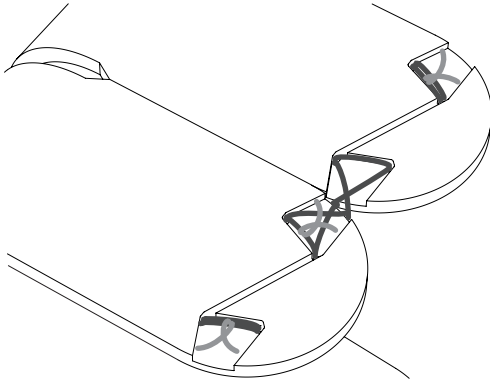

STEP 31

The knots on the foot part should fit into the pockets so the stool can sit flat on the ground.

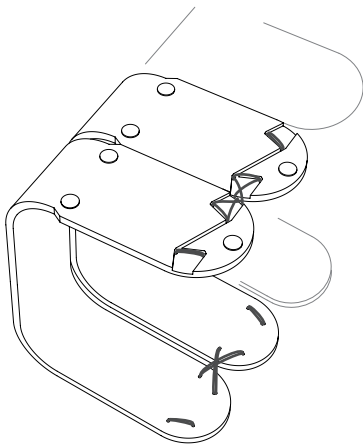

FELT PADS ON AND GO!

Apply the included felt pads – three on each part – to protect the wooden surface from scratching.

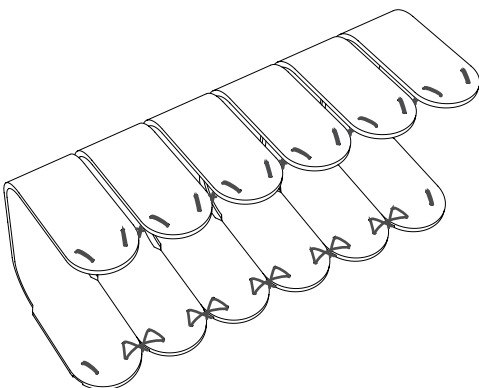

Congrats, you're done!

SHARING IS CARING

HELLO@MOWO.STUDIO
@MOWO_MOVEWITHWOOD
MOWO.STUDIO

CONGRATULATIONS!

You are now ready to swing, bounce, wiggle and rock... Find your own way to sit on the VIVI BENCH and change position to keep your body engaged.

All of our products are unique through their wood grain and cord colour. We'd love to see your creations and hear about your experience, your favourite sitting position and any other feedback you want to share.

Simply write us an email, send us a photo or link us on social media.

GUARANTEE & RETURNS

GUARANTEE

We offer a 2-year guarantee on all our stools.

RETURNS

We accept returns up to 30 days after you have received the parcel. For more information please visit the 'terms of service' and 'returns' section on our website.

MOVE

WITH

WOOD

THIS BOOKLET IS PRINTED ON
RECYCLED PAPER, MADE IN AUSTRIA

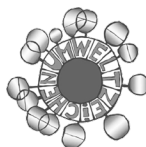

MOWO . STUDIO