

PARTS LIST

- A.** 1x Type A Main Harness (BB8K001)
- B.** 2x Short Y Splitter Adapters (BB8S001)
- C.** 2x Long Y Splitter Adapters (BB8S002)
- D.** 2x Extension Harness for Perimeter Strobe (BB8SE01)
- E.** 1x Type A Switch Harness
- F.** 1x 5 Core Pigtail
- G.** 6x Connector Caps
- H.** 18x Connector Retainers
- I.** 1x Inline Fuse Holder + 15 Amp Fuse

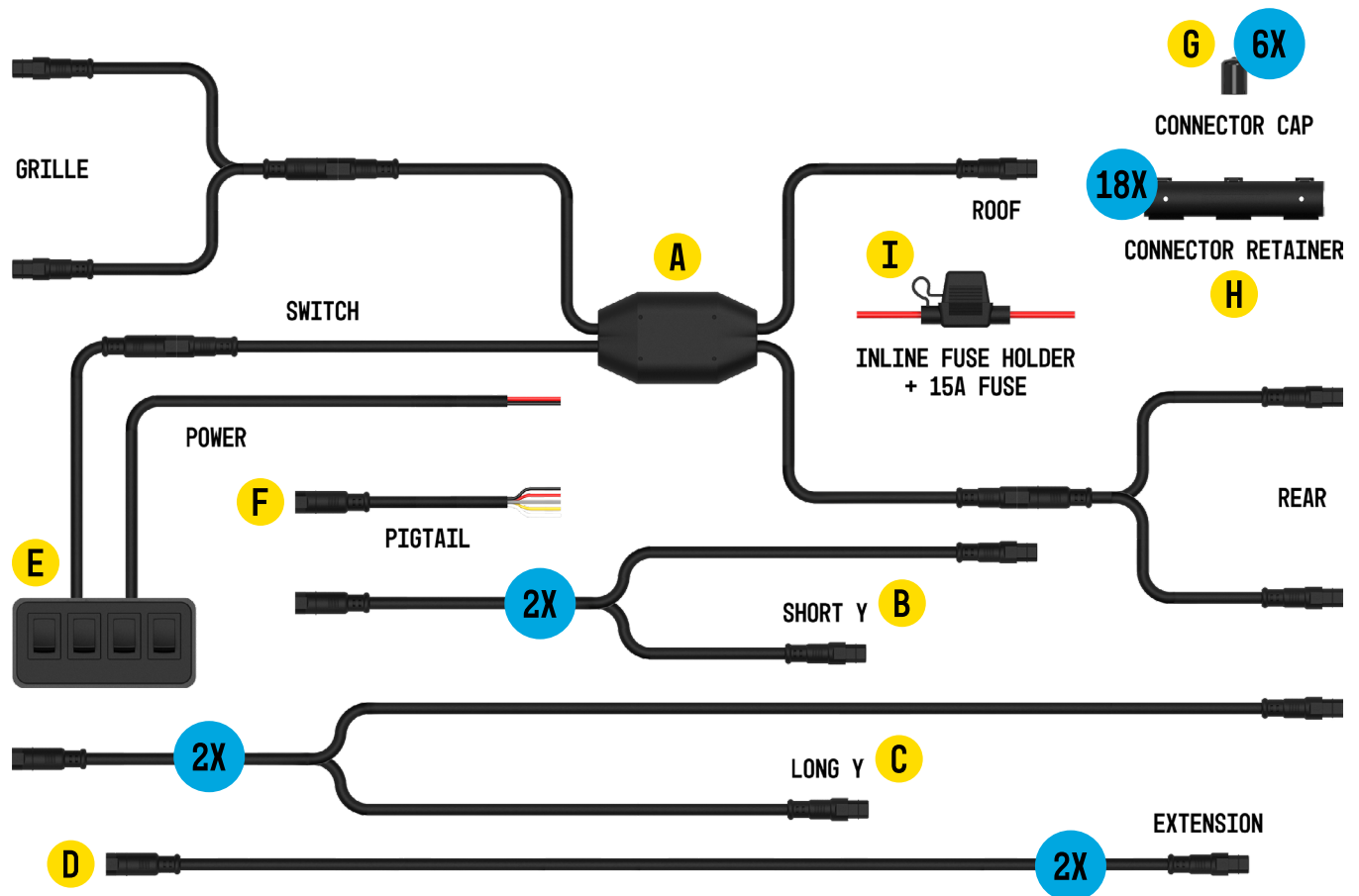

REQUIRED TOOLS

- Zip Ties
- Cable Clips



INSTALL NOTES

- No cutting or drilling is required for the installation of the front grille strobes or roof top mini bar.
- Drilling is only required when mounting the lights on the rear tail gate, bumper or on the body of the truck.
- Approximate installation time is 2 hours (not including bracket installation).
- **Lights are not included in this kit. Compatible lights are listed below.**

COMPATIBLE LIGHTS

SKU	PERIMETER STROBE	COLOR
BB6110A	4" Strobe Light, Amber (1EA)	Amber
BB6110B	4" Strobe Light, Amber/White (1EA)	Amber/White
BB6110C	4" Strobe Light, Amber/Blue (1EA)	Amber/Blue
BB6110D	4" Strobe Light, Amber/Green (1EA)	Amber/Green
BB6010A	4" Strobe Light, Amber (1EA)	Amber
BB6010B	4" Strobe Light, Amber/White (1EA)	Amber/White
BB6010C	4" Strobe Light, Amber/Blue (1EA)	Amber/Blue
BB6010D	4" LED Strobe Light, Amber/Green (1EA)	Amber/Green
BB6001BK	Mini Light Bar 12", Amber/White (1EA)	Amber/White
BB6001CK	Mini Light Bar 12", Amber/Blue (1EA)	Amber/Blue
BB6001DK	Mini Light Bar 12", Amber/Green (1EA)	Amber/Green
BB6011AK	Mini Light Bar 15", Amber (1EA)	Amber
BB6011BK	Mini Light Bar 15", Amber/White (1EA)	Amber/White
BB6011CK	Mini Light Bar 15", Amber/Blue (1EA)	Amber/Blue
BB6011DK	Mini Light Bar 15", Amber/Green (1EA)	Amber/Green

DIMENSIONS

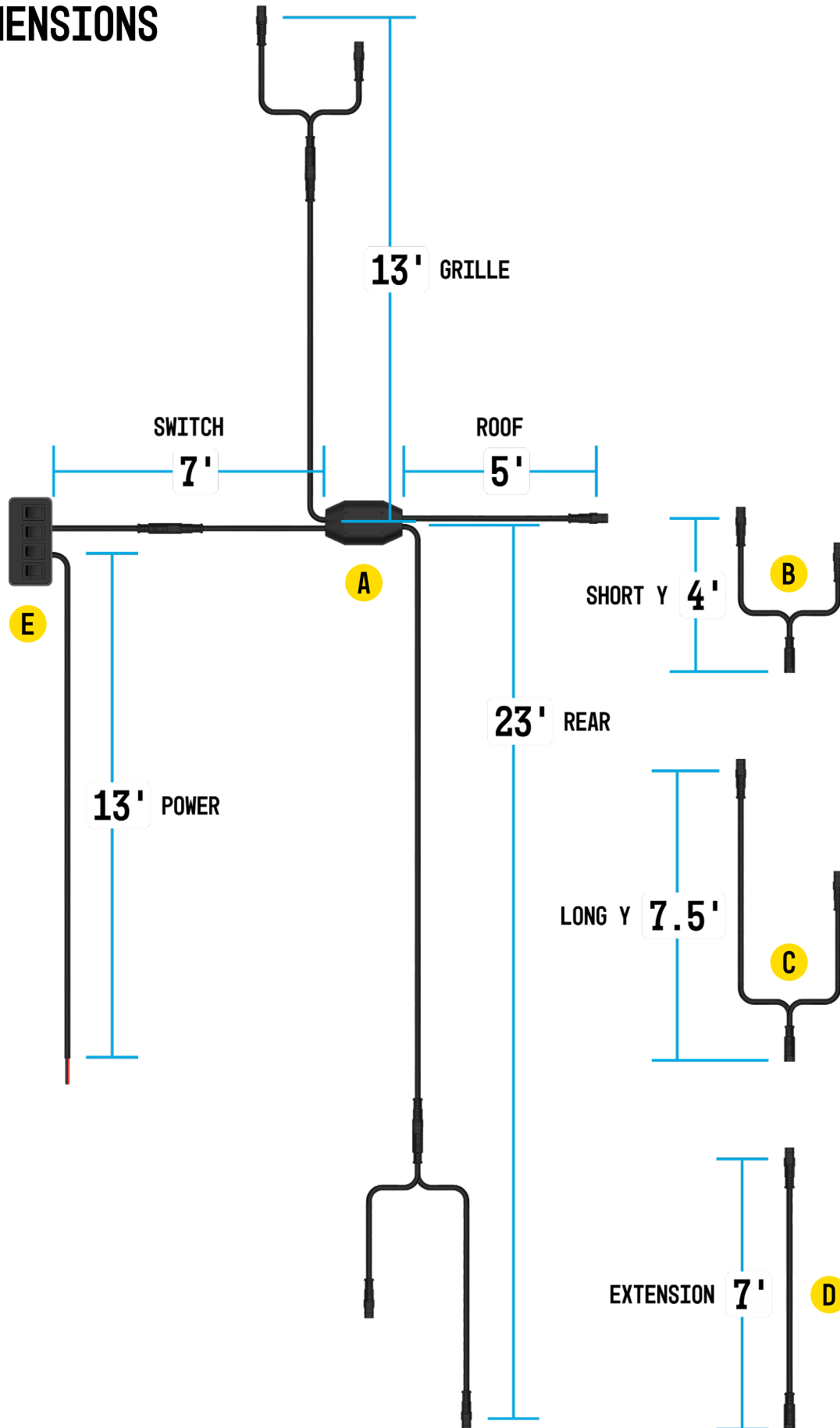



STEP 1 – PLAN THE INSTALL

1. Unbox your harness kit and verify that all parts are present.
 2. Lay out the harness and plan where to install the perimeter strobes (sold separately). Plan and lay out the necessary adapters and extensions alongside the Main Harness (A).
- **Note:** There are 2x Short Y Splitter Adapters (B) and 2x Long Y Splitter Adapters (C) included in this kit. Please choose the proper adapter according the location you want to install your lights. Examples:
 - The Short Y Splitter Adapters (B) are long enough if you install the front perimeter strobes in the grille. If you want to install the lights on the bumper or side of the vehicle, you may need to use the Long Y Splitter Adapters (C).
 - The Short Y Splitter Adapters (B) are long enough if you install the rear perimeter strobes under the tail gate. If you want to install the lights on the side of the vehicle, you may need to use the Long Y Splitter Adapters (C).
 - The standard harness and splitter adapters are long enough for standard pick up truck beds or flat beds up to 10' long. If you choose to install the rear perimeter strobes on a truck body and route the harness through the cabin, you may need to use the Extension Harness for Perimeter Strobe (D).
 - **An example configuration is shown on the next page for reference.**



EXAMPLE CONFIGURATION

This example uses Harness Kit #BB8KA08, 8x Perimeter Strobe #BB6110B, 1x 12" Mini Light Bar #BB6001BK, 2x Grille Bracket Kit #BB96GFA and 1x 3rd Brake Light Mount Bracket Kit #BB96RFA.

Lights and brackets are sold separately.

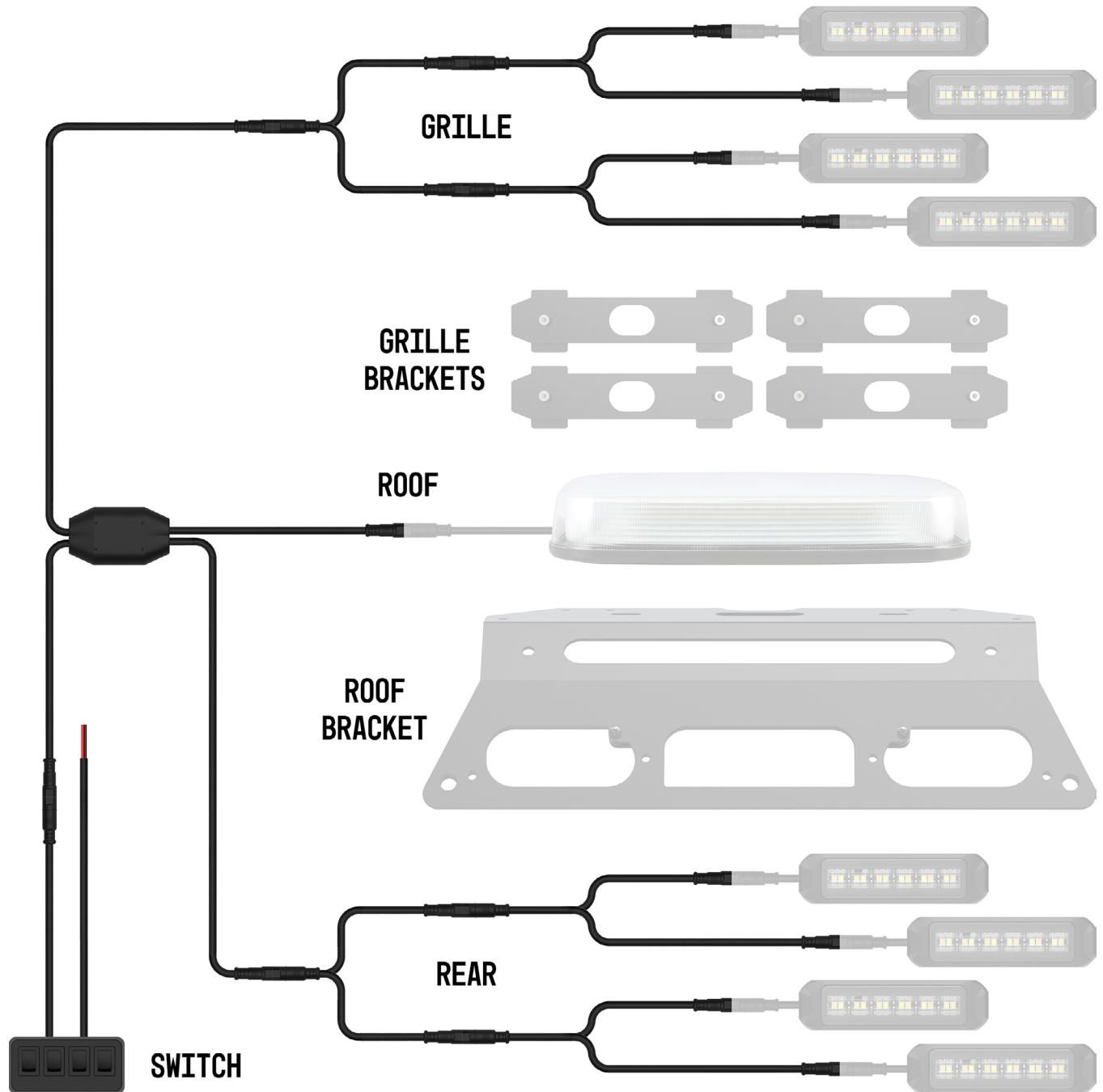

STEP 2 – PROGRAM THE PERIMETER STROBE LIGHTS

We suggest programming the lights and testing harness functionality before beginning installation on the vehicle.

1. Unbox all of the perimeter strobe lights. A waterproof 5 pin male connector and a female pigtail are included in the package of each light.
2. Unplug the lights from the pigtails (Fig. 1) and plug the lights into the Y splitter adapters of the Main Harness (A).
3. After all lights are plugged into their locations, unplug the grille and rear connectors from the Main Harness (A) (Fig. 2).



FIG. 1

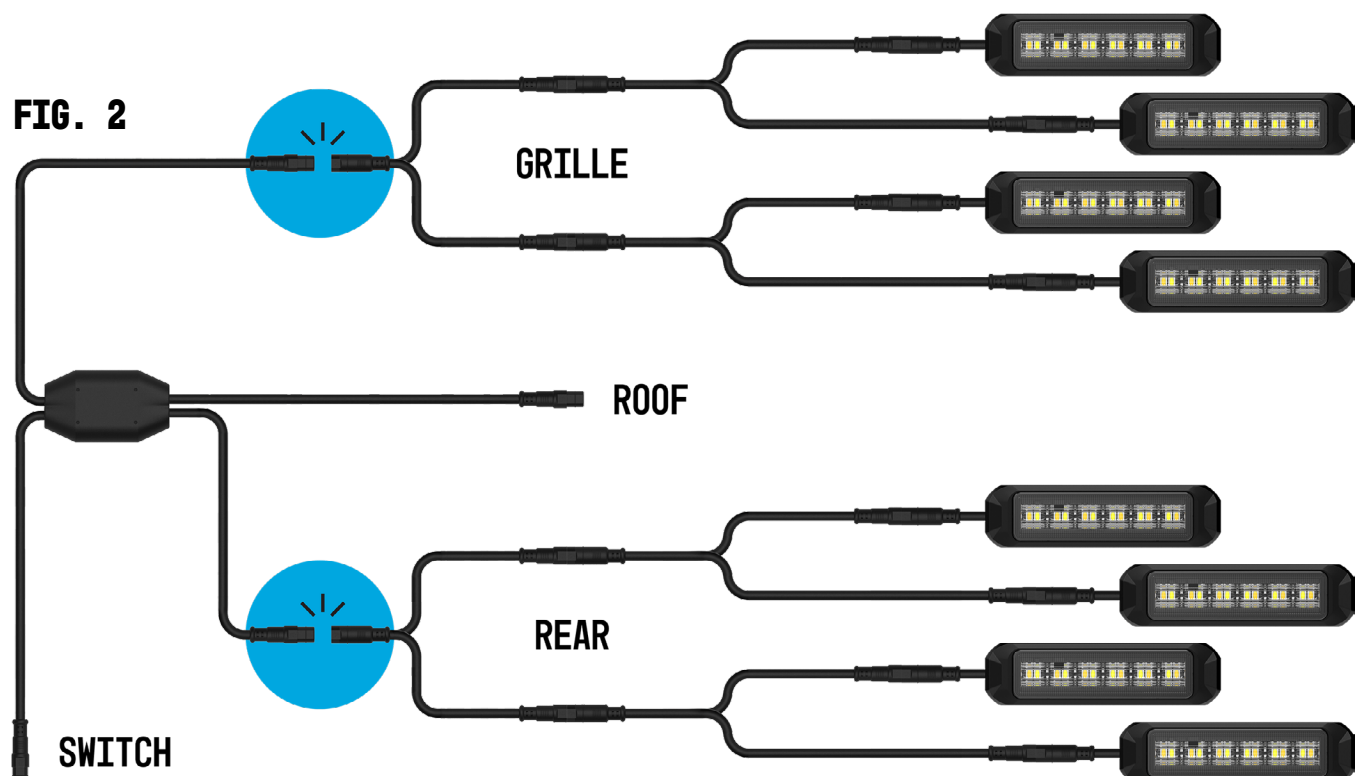
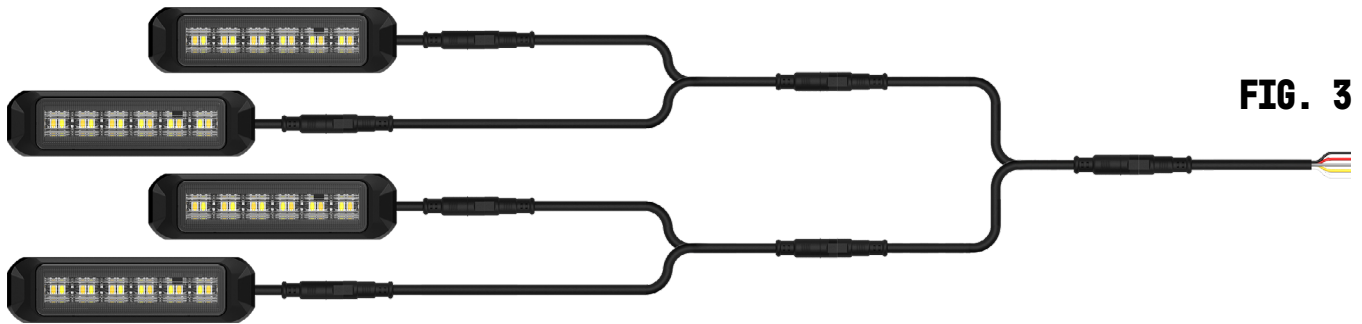

FIG. 2

STEP 2 – PROGRAM THE PERIMETER STROBE LIGHTS

- Use two of the 5 core pigtails that come with the perimeter strobe lights to program each of the light bundles separately (Fig. 3). If preferred, connect the wires of the pigtails together to program all 8 lights at once.



- See Fig. 4 for individual wire functions. Refer to the perimeter strobe light instructions to program the **RED** and **GREY** wires to desired strobe patterns.
- Unplug the programming pigtail and leave the light bundles unplugged from the Main Harness (A). They will be connected to the Main Harness (A) once it's routed through the vehicle.

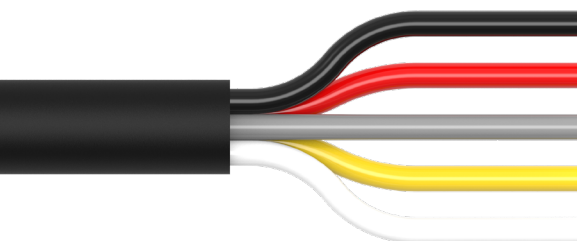

FIG. 4

BLACK - Ground

RED - To +V DC, Programmable Mode 1

GREY - To +V DC, Programmable Mode 2

YELLOW - Pattern Selection

WHITE - Inactive

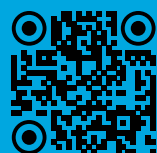

SCAN FOR VIDEO PROGRAMMING
INSTRUCTIONS OR VISIT
BUILT-BRIGHT.COM/PROGRAM

STEP 3 – INSTALL THE HARNESS AND LIGHTS

1. Prior to routing through the vehicle, cap the Main Harness (A) connectors with provided Connector Caps (G). Capping the connectors is highly recommended to prevent dirt or grease getting into the female connectors during installation.





STEP 3 – INSTALL THE HARNESS AND LIGHTS

2. Locate the vehicle's main harness along the frame rail. Route the StrobeLink™ Main Harness (A) alongside it, starting under the cab and working towards the rear.
 3. Remove the Connector Cap (G) and connect the Y splitter adapter for the rear strobe lights.
 4. Route the front portion of the harness under the cab and into the engine bay. Secure to the vehicle's wiring on the firewall or inner fender. **Do not rest the wires against the exhaust.**
 5. Remove the Connector Cap (G) and connect the Y splitter adapter for the front strobe lights.
 6. Locate the Main Harness (A) wire labeled "Top" and route it through the vehicle towards the top of the cab. Connect the mini light bar.
- **An example configuration is shown on the next page for reference.**



EXAMPLE CONFIGURATION





STEP 4 – INSTALL THE LIGHT CONTROL

There are 3 options to control your strobe lights:

1. Use Provided Switch Panel
 2. Use Upfitter Switches
 3. Use 3rd Party Switches
- Note: If the battery or fuse box of the vehicle is on the passenger side , you will need Power Extension Cable BBSE02 (sold separately) to extend between the power connector on the Switch Harness (E) and the pigtail to reach the power source.

Each option is outlined individually on the next 2 pages.

STEP 4 OPTION 1 – USE PROVIDED SWITCH PANEL

1. Connect the Switch Harness (E) to the Main Harness (A). Temporarily connect to a 12V DC power source to test switch functionality. Disconnect the Switch Harness (E) once verified.
2. Enlarge the main harness boot hole on the firewall and route the switch wire of the Main Harness (A) into the cab.
3. Determine the switch panel location and route the Switch Harness (E) switch wire through or under the dashboard and connect it to the Main Harness (A).
4. Route the Switch Harness (E) power wire in the previously cut hole (main harness boot on firewall) and route to the battery.
5. Connect the **BLACK** wire to ground. Connect the **RED** wire to battery power. Add Inline Fuse Holder + 15 Amp Fuse (I).

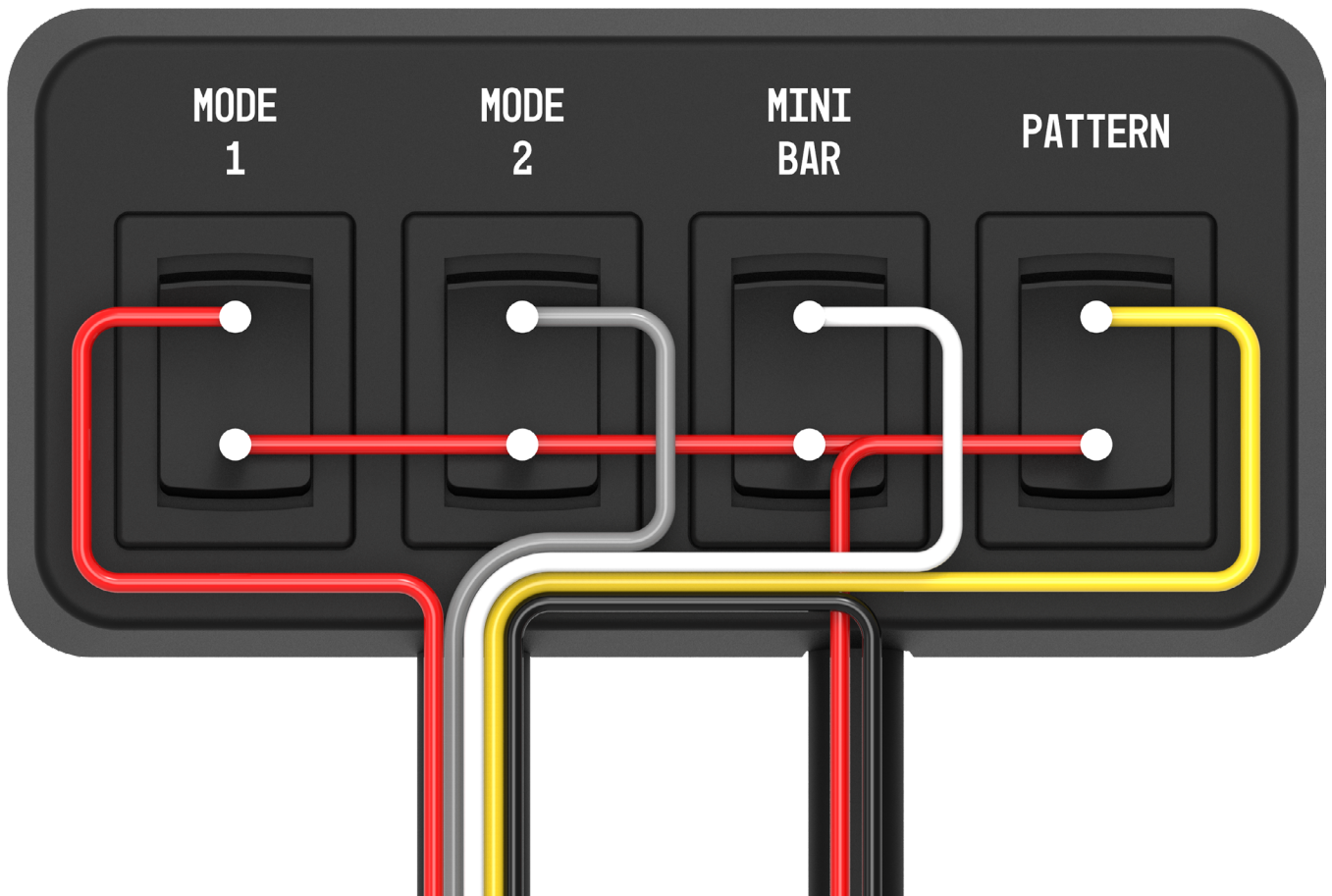

STEP 4 OPTION 2 – USE UPFITTER SWITCHES

1. Plug the provided 5 Core Pigtail (F) into the switch connector on the Main Harness (A). See Fig. 5 for individual wire functions.
2. Locate the upfitter switch relay in the engine bay.
3. Connect the **BLACK** wire to ground.
4. Connect the **RED**, **GREY** or **WHITE** wire to the desired upfitter switch relay. When the upfitter switch is activated, that light and pattern will trigger.
5. Secure any slack with zip ties. Unused wires should be separated and protected using heat shrink or tape.

STEP 4 OPTION 3 – USE 3RD PARTY SWITCHES

1. Plug the provided 5 Core Pigtail (F) into the switch connector on the Main Harness (A). See Fig. 5 for individual wire functions.
2. Follow the same wiring instructions from Option 2 above.

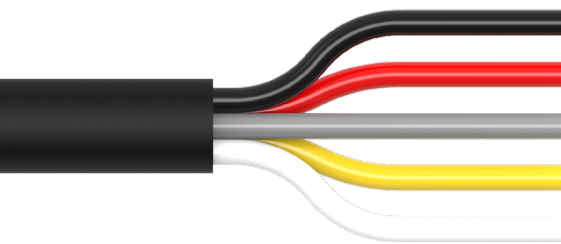

FIG. 5

BLACK - Ground

RED - To +V DC, Programmable Mode 1*

GREY - To +V DC, Programmable Mode 2*

YELLOW - Mini Bar Pattern Selection

WHITE - Mini Bar On/Off

* Perimeter Strobe Lights Only

STEP 5 – TEST + COMPLETE

1. Test the StrobeLink™ setup for desired functionality. Once verified, secure any wire slack with zip ties.
2. Use the provided Connector Retainers (H) to secure connections. If your vehicle is operated in a high-corrosion environment, apply dielectric grease in the connectors for additional corrosion protection.
3. If there is an unused connector exposed, use a Connector Cap (G) to cap it off. Wrap tape around the cap to secure.

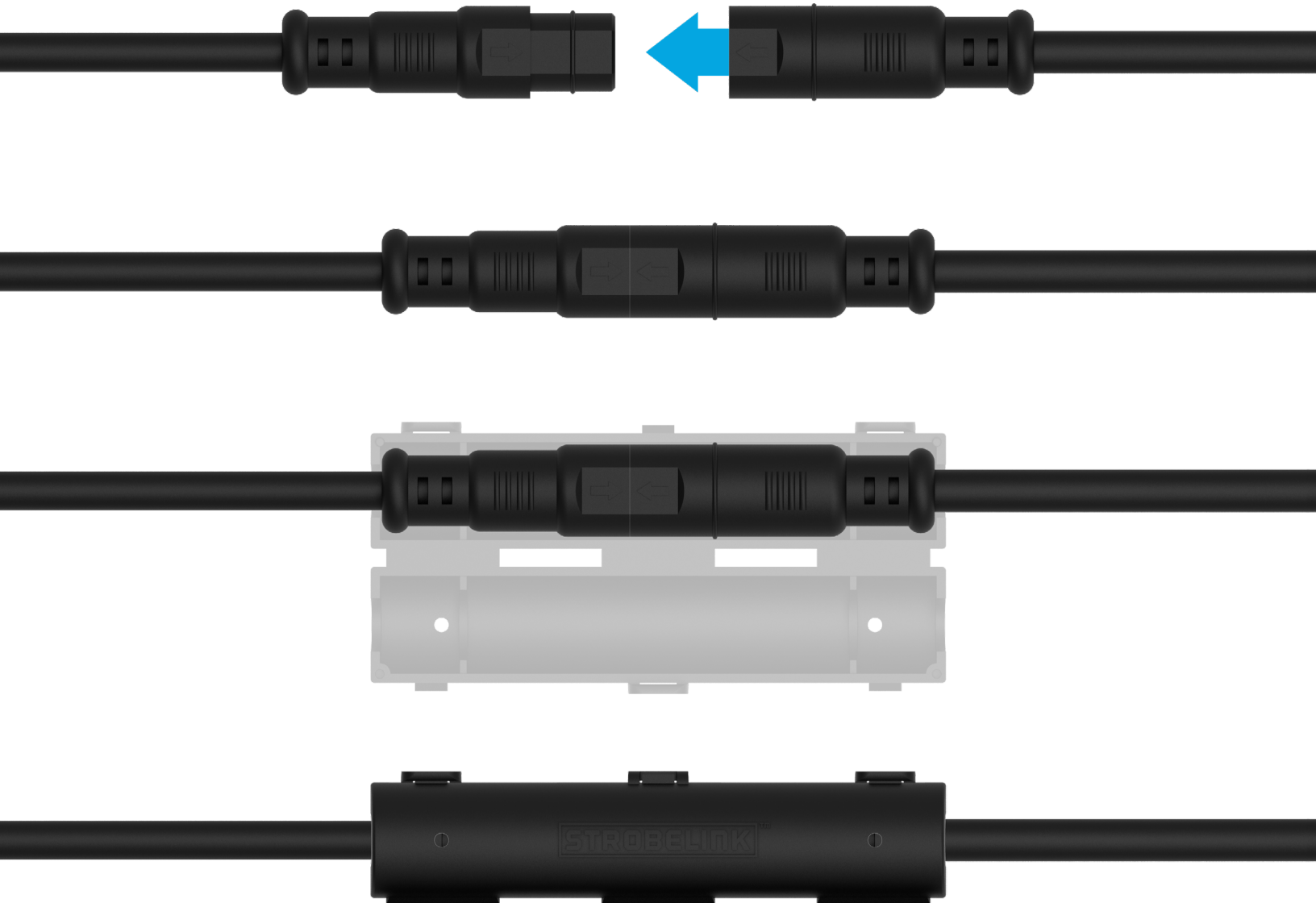

STROBELINK™

ALL-IN-ONE STROBE LIGHT KIT

BUILTBRIGHT

BASTROP, TEXAS 78602
UNITED STATES OF AMERICA
WWW.BUILT-BRIGHT.COM

