

Floor Area - 75 sq ft

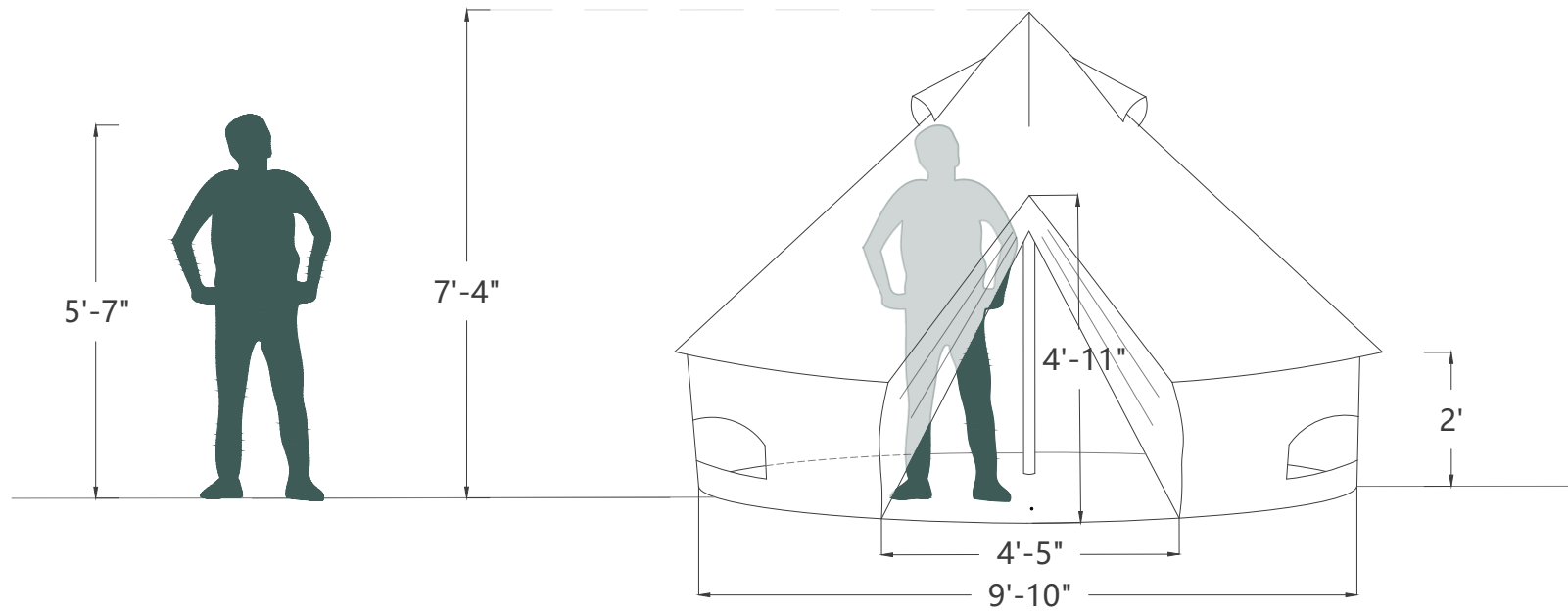

3D VIEW

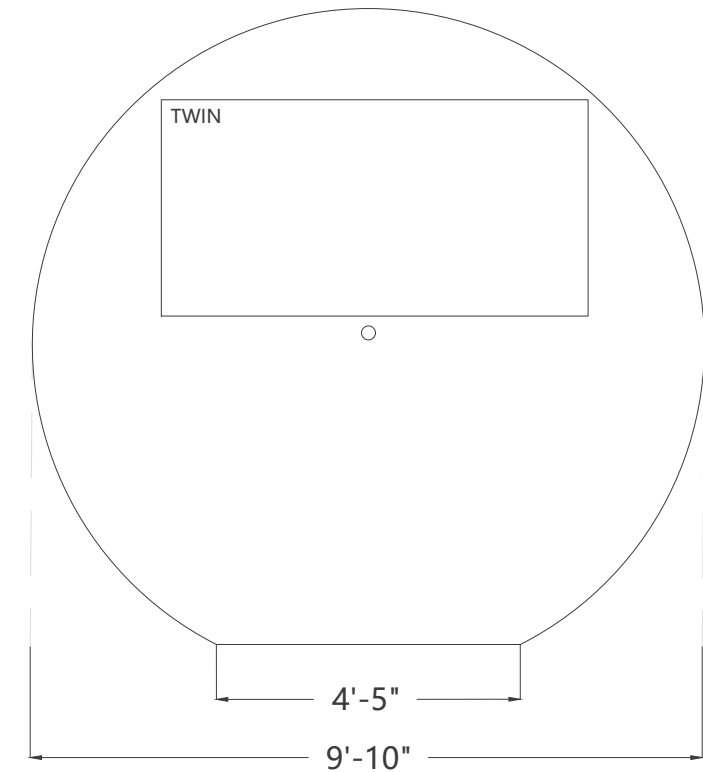

PLAN 1

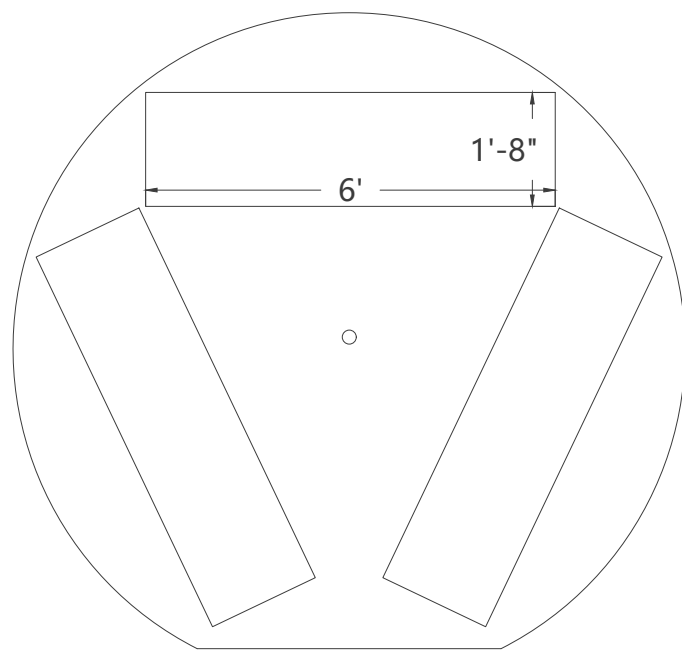

PLAN 2

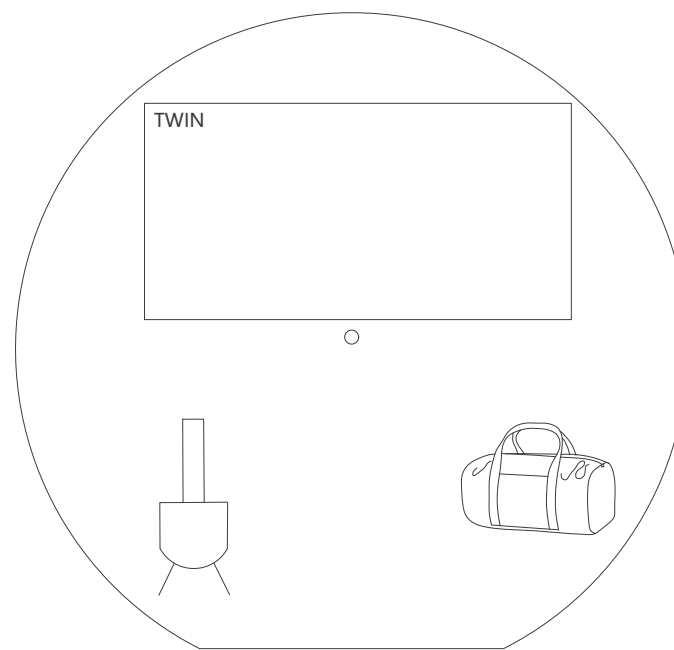

PLAN 3

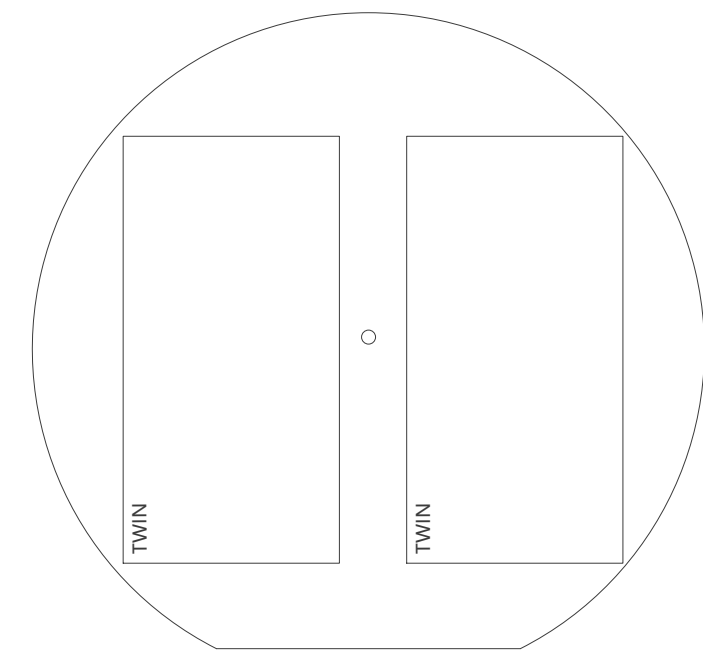

PLAN 4

NOTE - KING - 6'2" X 7'3"
 QUEEN - 5'0" X 6'8"
 DOUBLE - 4'6" X 6'2"
 TWIN - 3'2" X 6'2"

DWG NO.	01 - 300	A3
SCALE:1:1	SHEET 1 OF 8	