

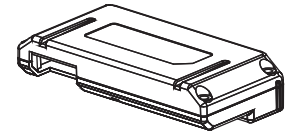

Yale *real* Living

Yale Real Living® Assure Lock™ Key Free Touchscreen Deadbolt Installation and Programming Instructions (YRD246/YRD446)

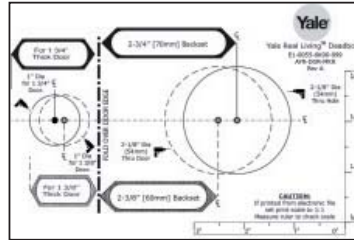
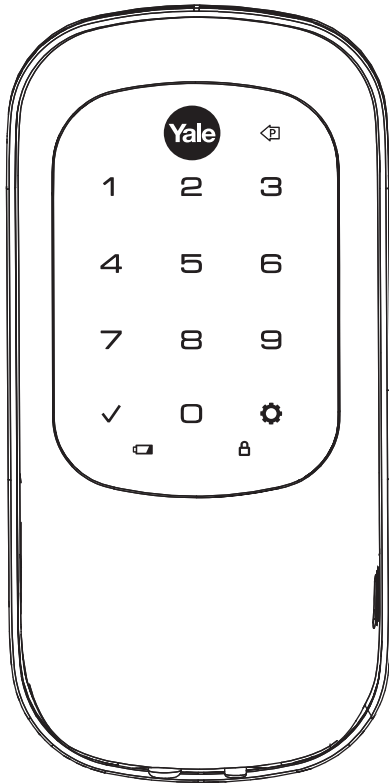

Optional Network Module

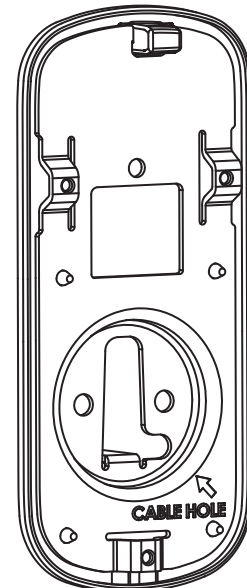
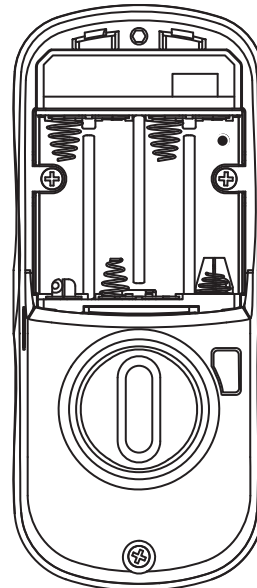

CABLE HOLE

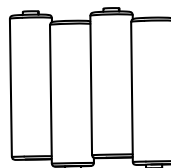
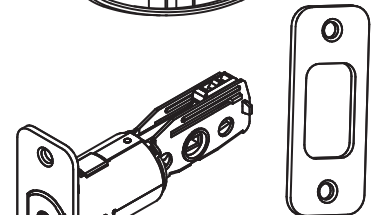
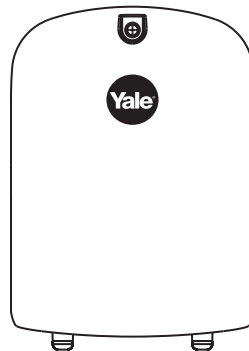

x4
#7 wood & #8-32 machine x 20mm Combination screws



x3
#8-32 x 5/16" Machine screws

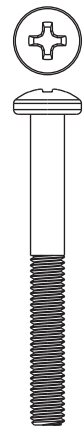

x2
M6x55mm Long through bolt

Before you begin

DOWNLOAD THE BILT APP

for 3D interactive instructions & to register your product



BILT.



FAILURE TO FOLLOW THESE INSTRUCTIONS
COULD RESULT IN DAMAGE TO THE PRODUCT
AND VOID THE FACTORY WARRANTY

1

Installing Latch & Strike Plate



x4

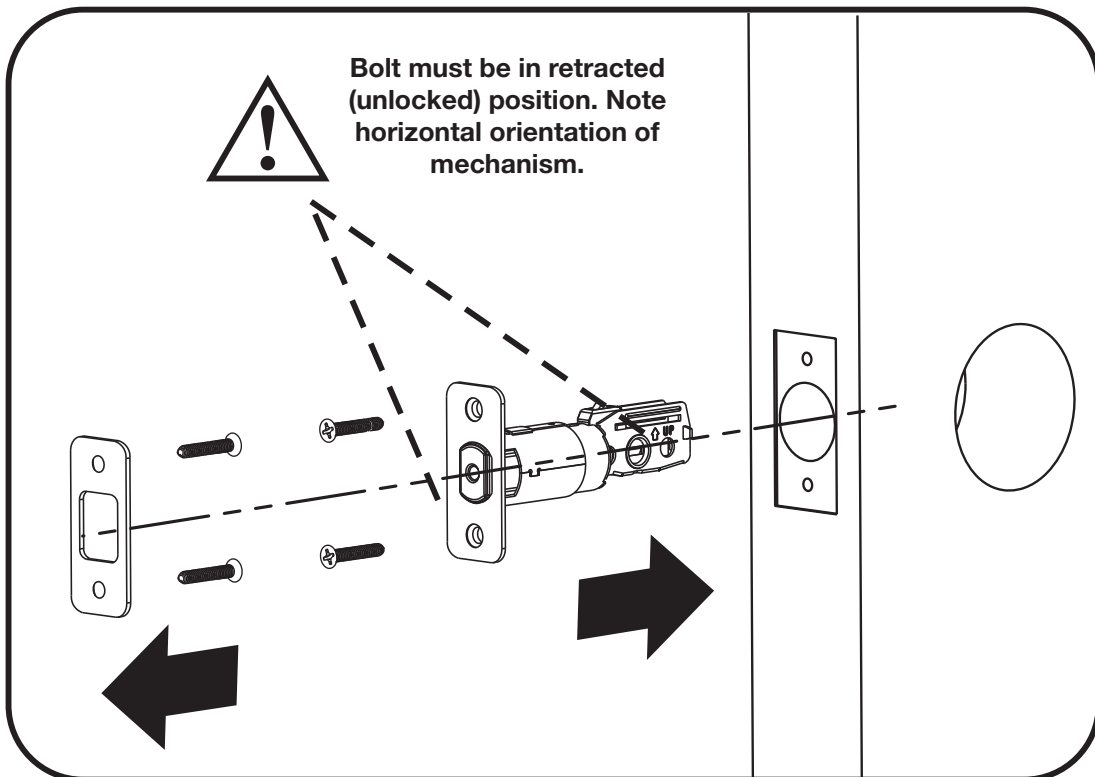
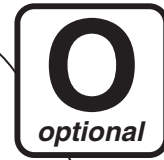
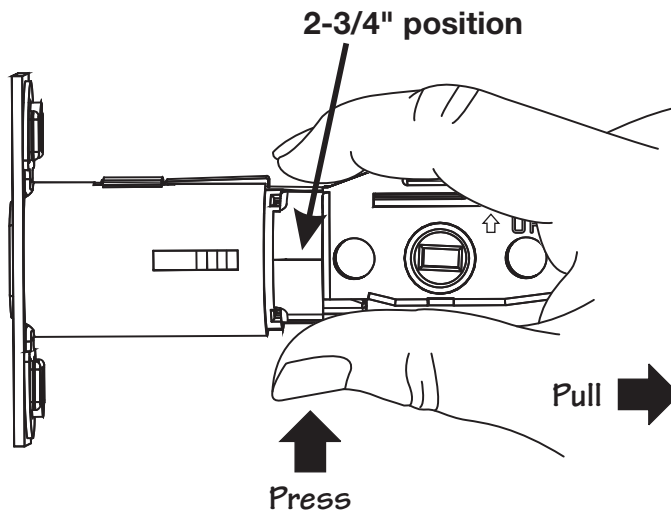
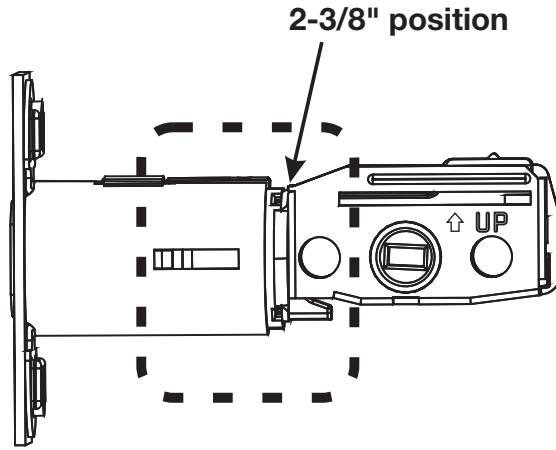

2

Installing Touchscreen Escutcheon

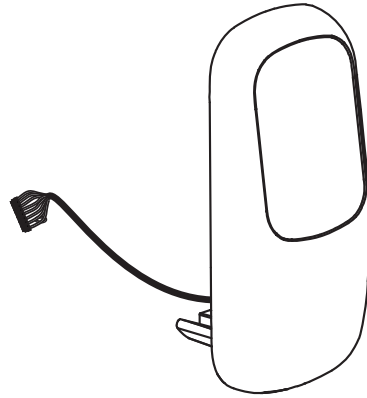

Inside of Door

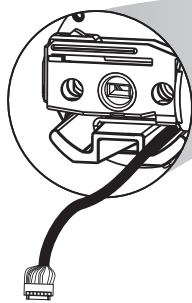

Outside of Door

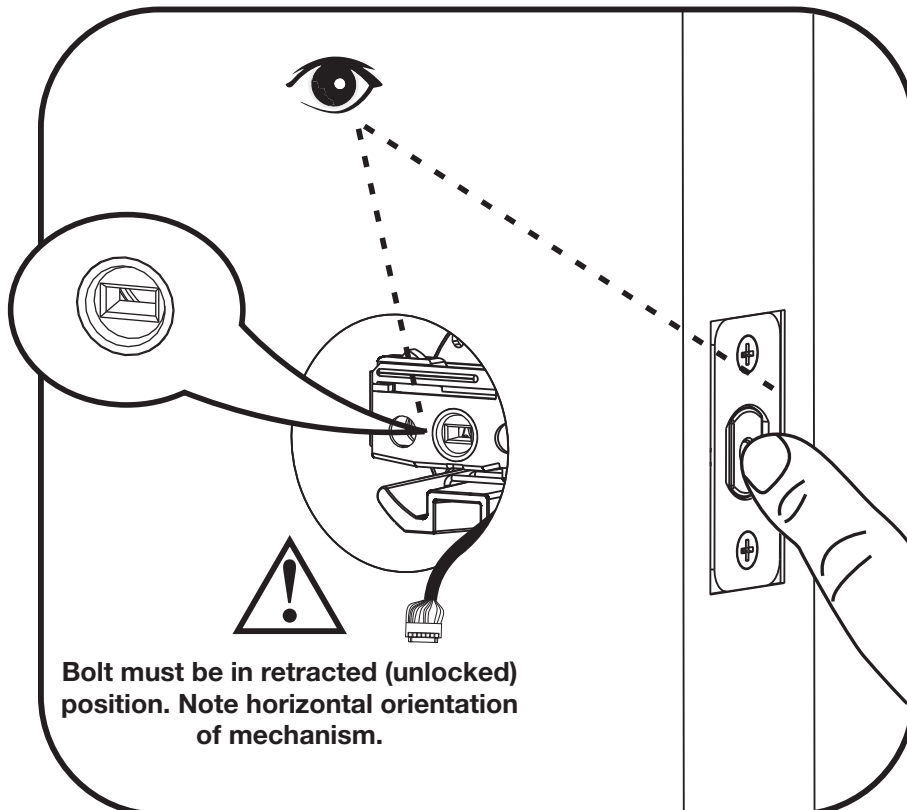
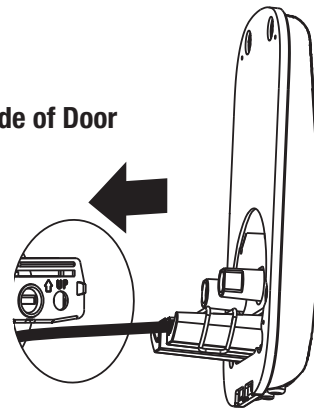

3

Installing Interior Mounting Plate

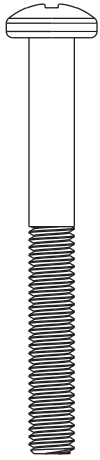

x2

Loosen screw to
remove cover.

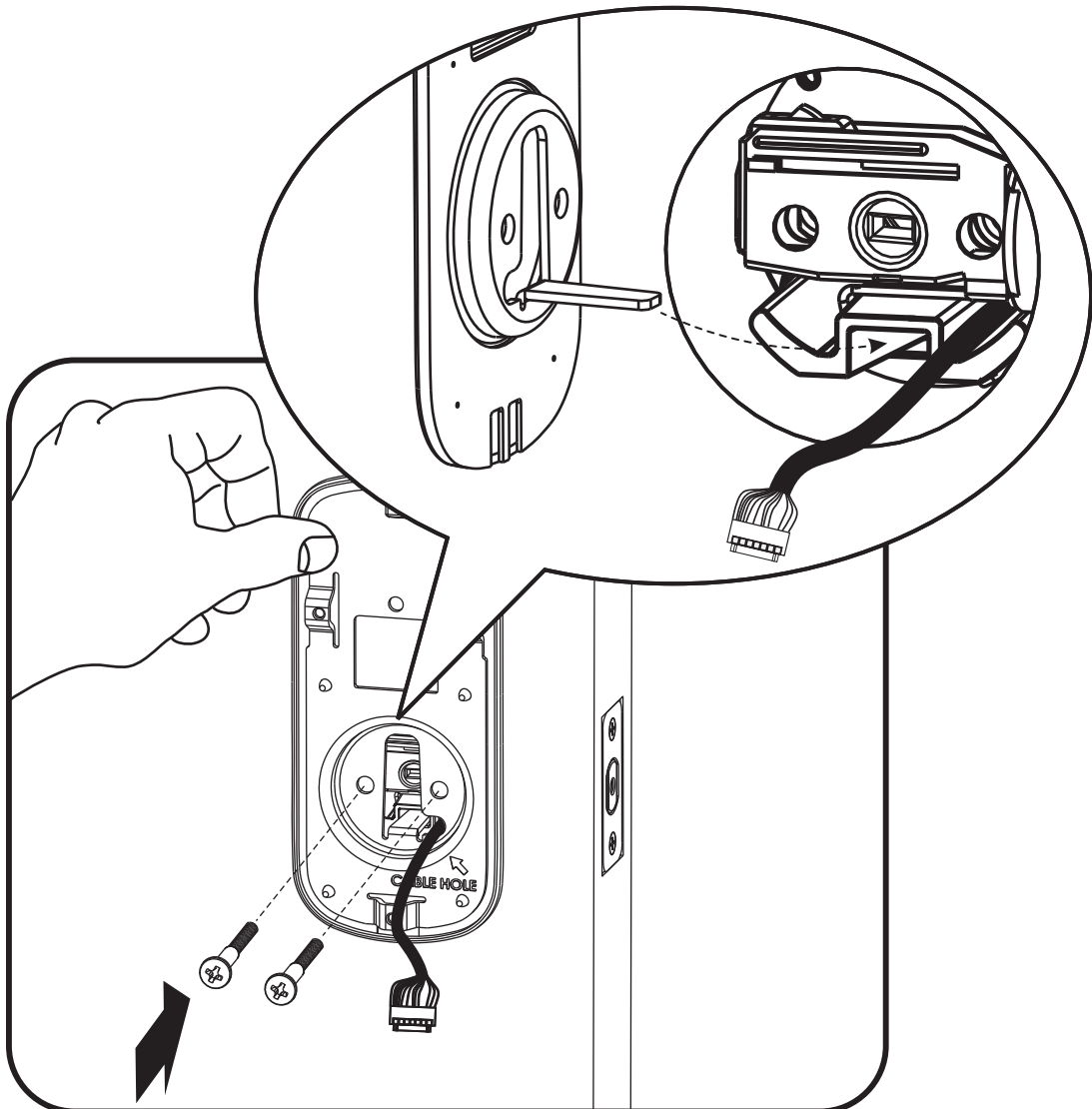
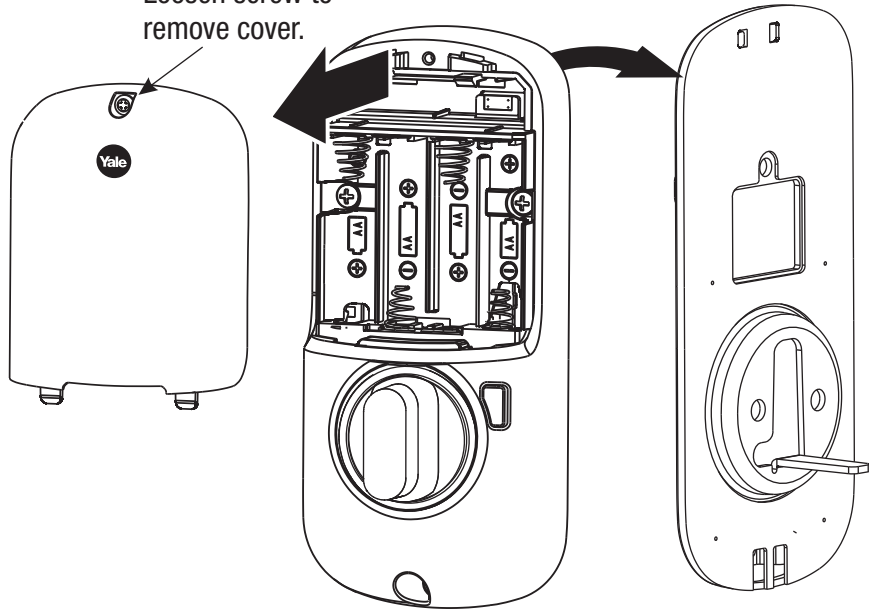

4

Attaching the Cable Assembly

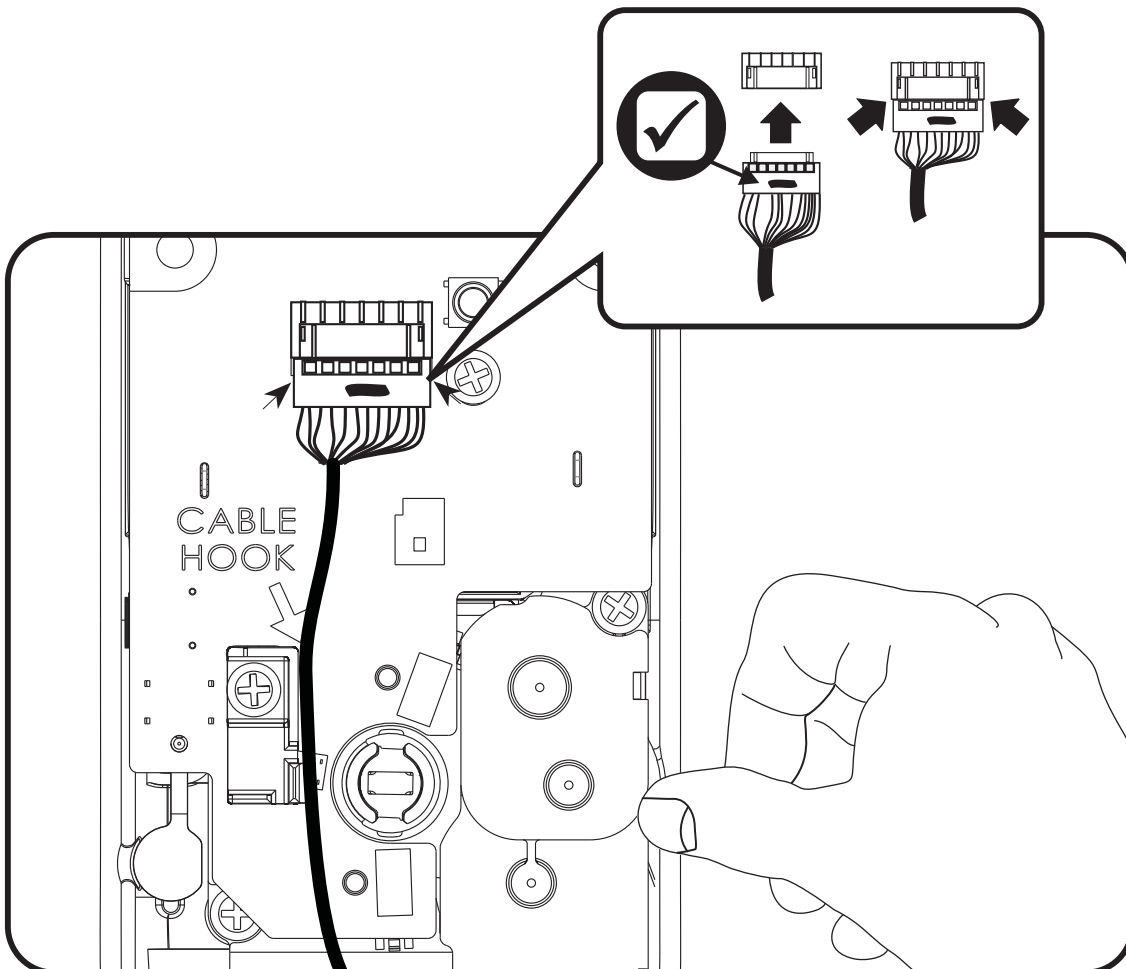
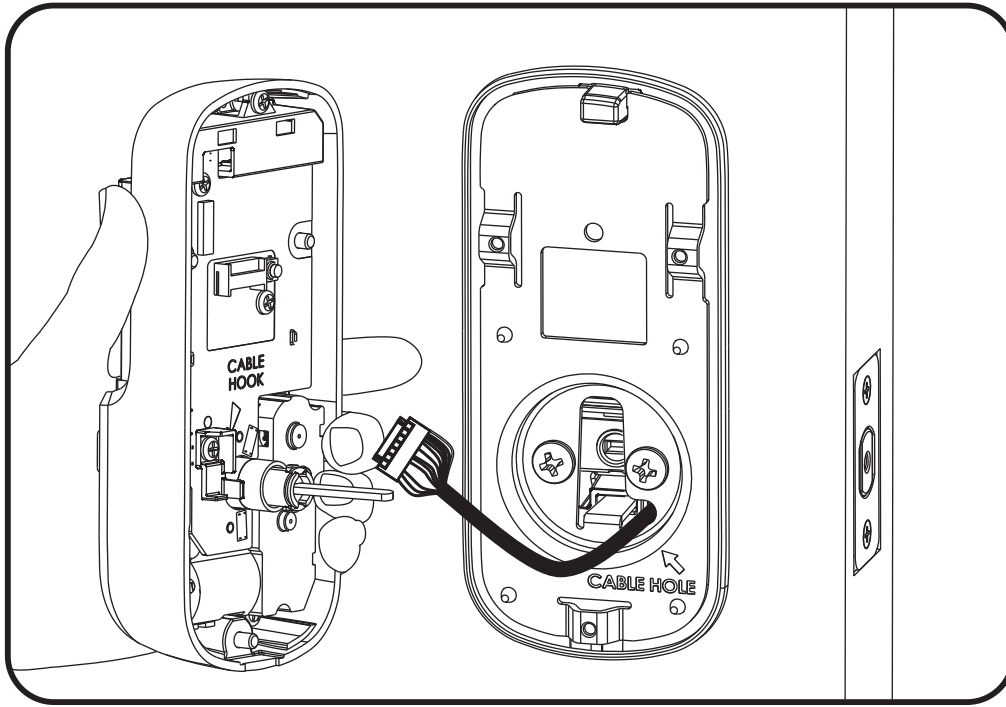

5

Installing Interior Escutcheon



x3

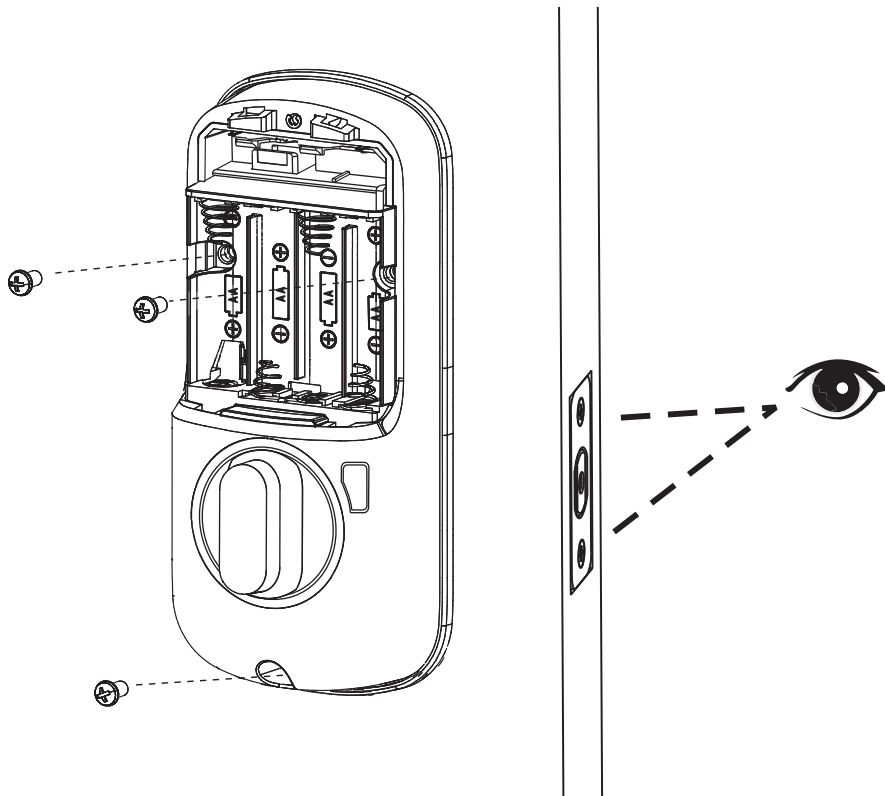
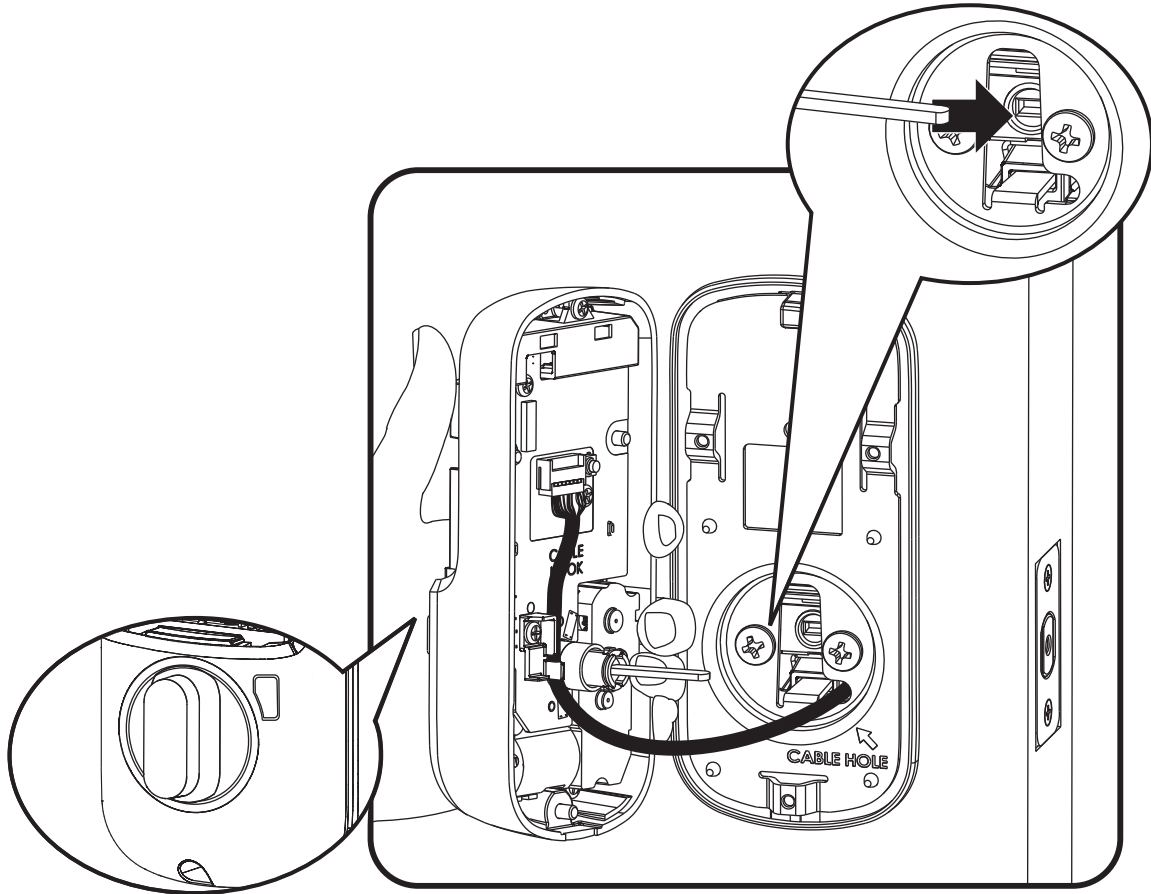



Testing Operation

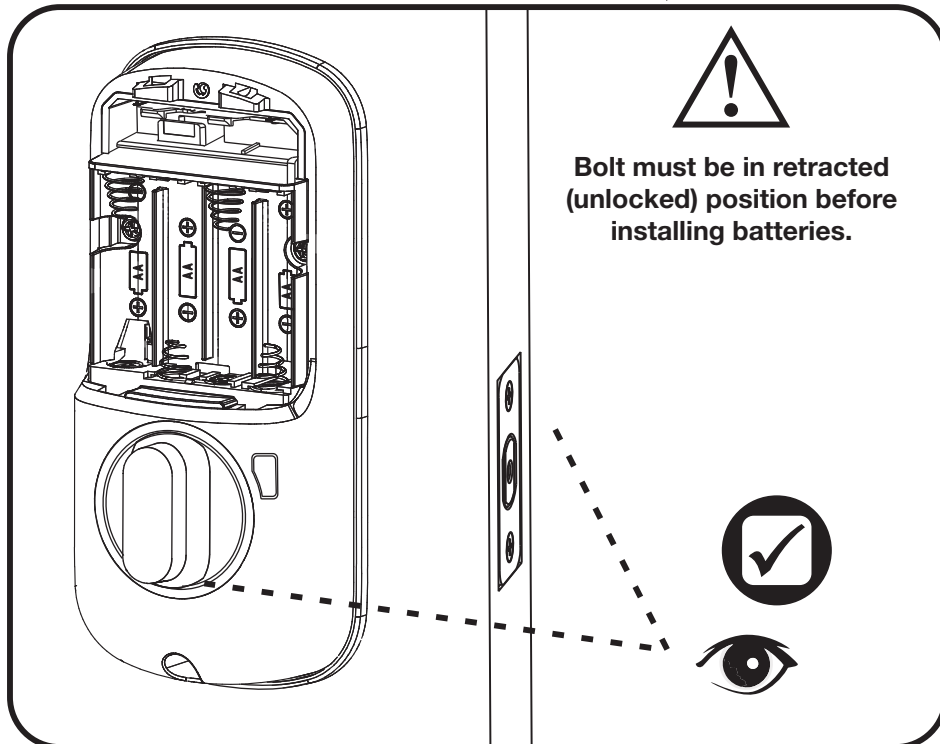
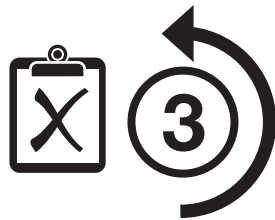
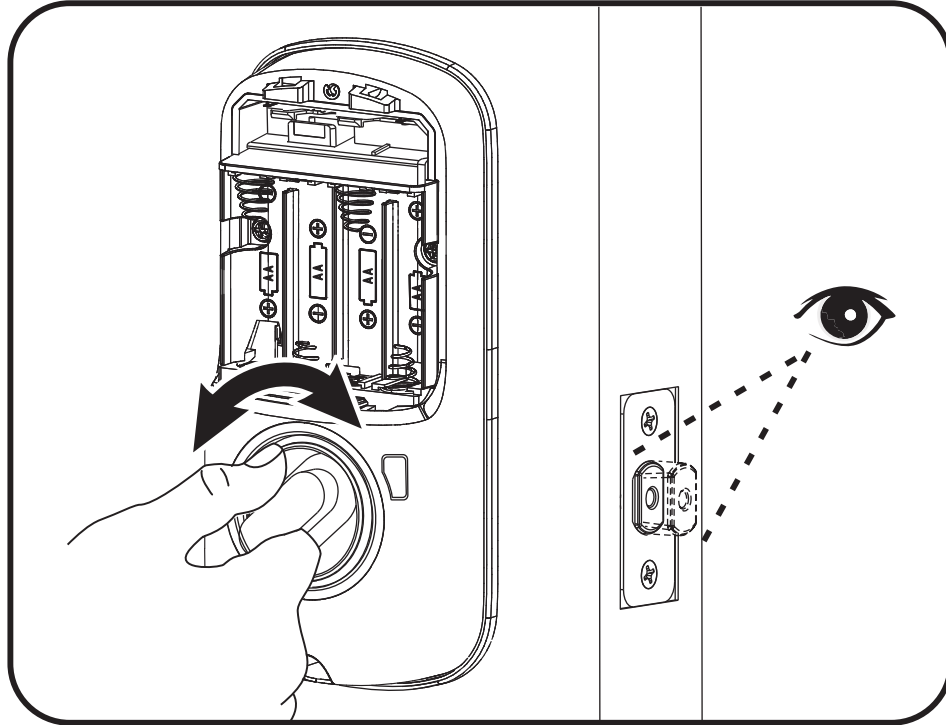

6

Installing Batteries/Handing the Lock

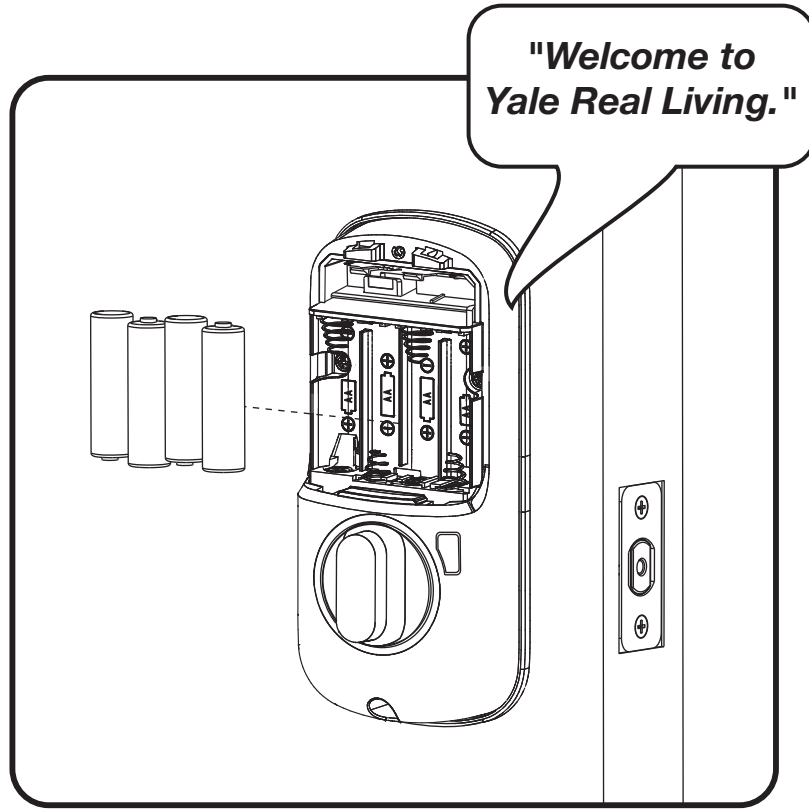

Lock automatically adjusts for proper handing.

7

Installing Optional Network Module

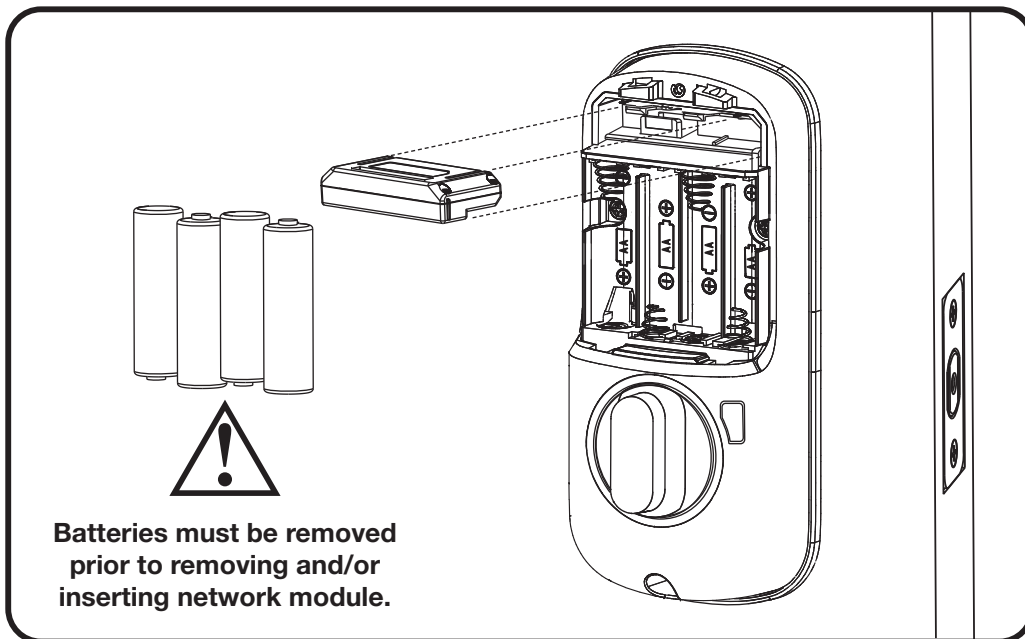

8

Installing Cover

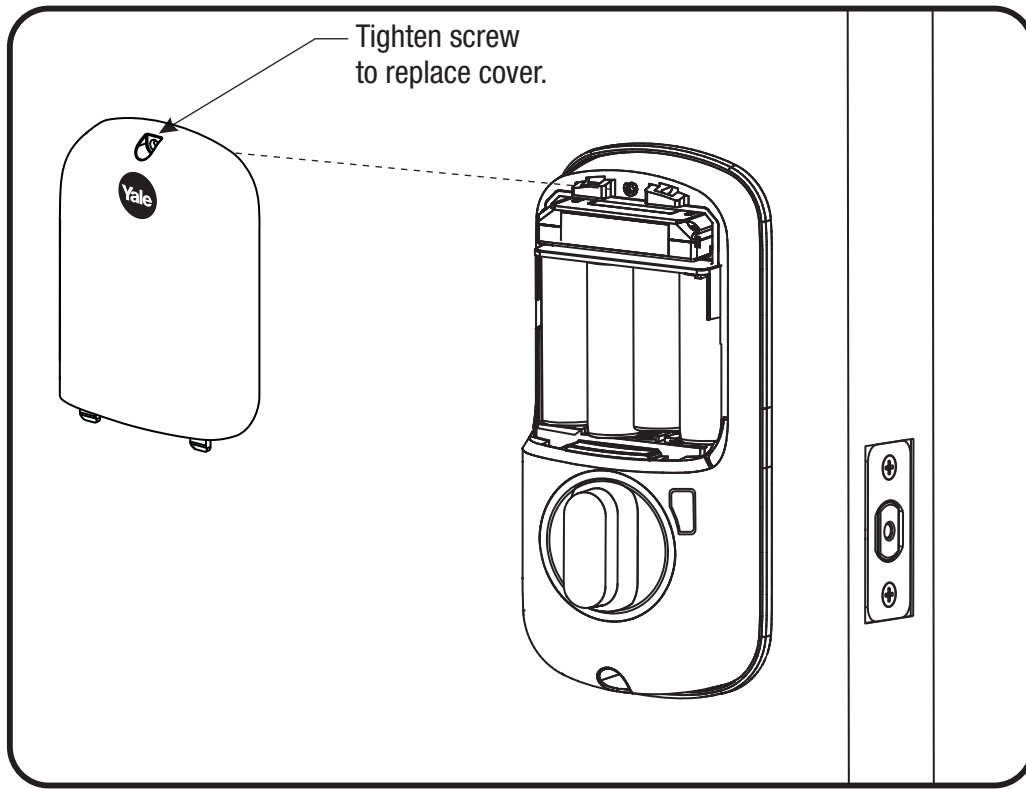

Congratulations, you've installed the Yale Real Living® Assure Lock™
Key Free Touchscreen Deadbolt (YRD246/YRD446)!
Continue with Programming Instructions to customize your product.

Programming Instructions

Exterior Escutcheon

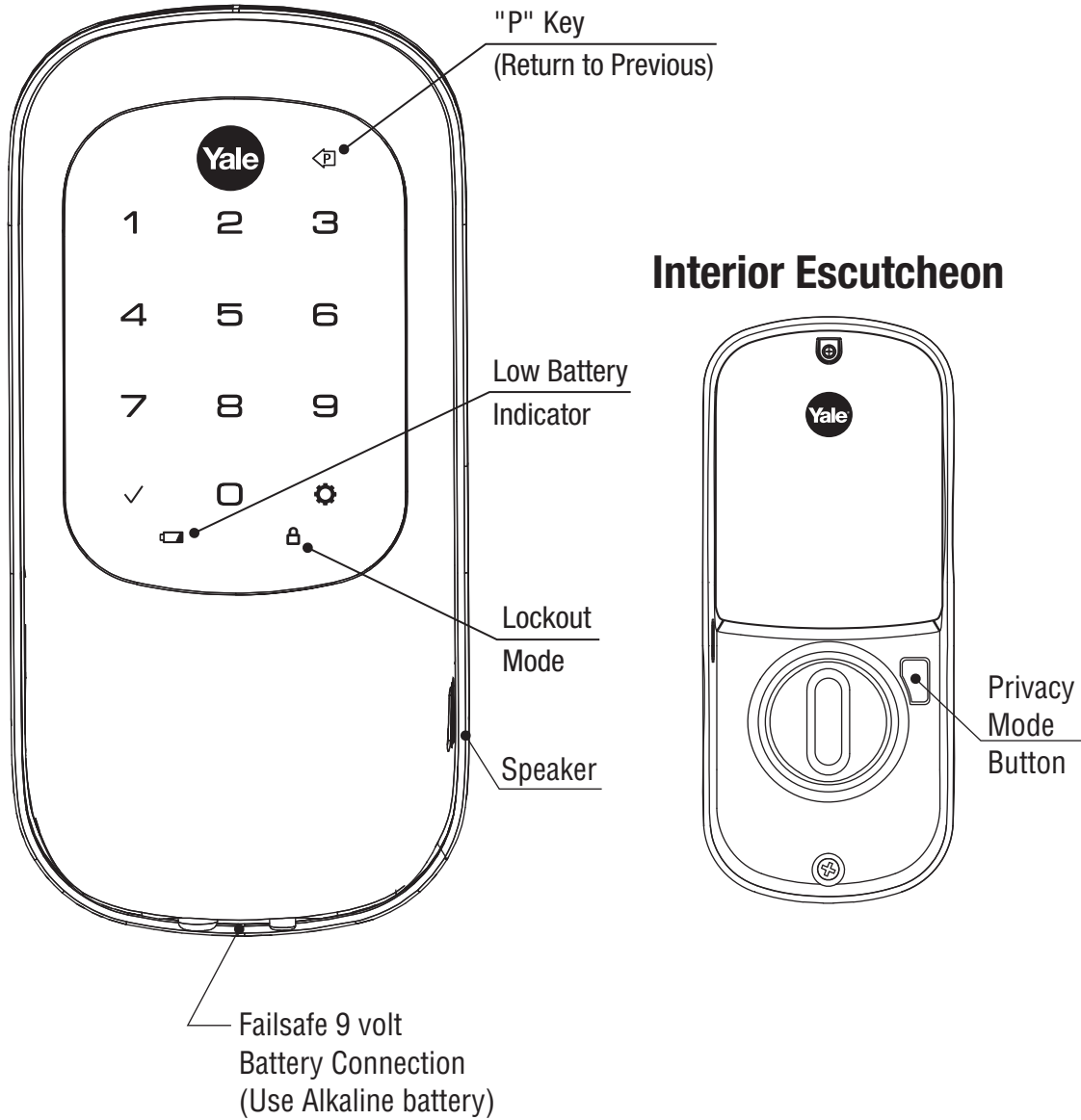

Interior Escutcheon

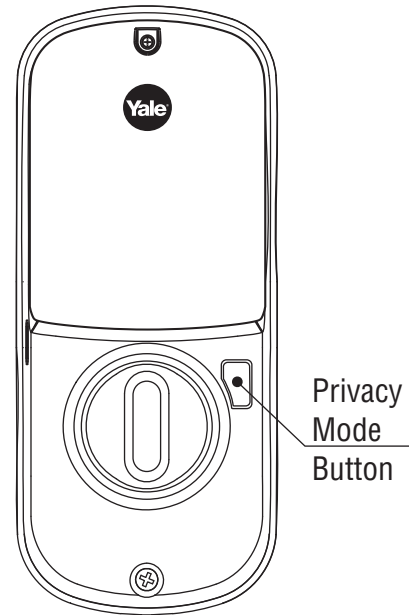

Lock Activation

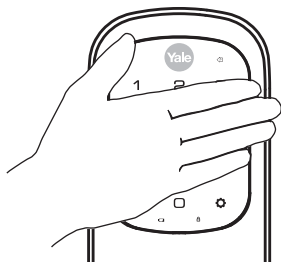

OR

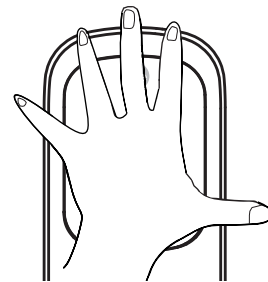

Master PIN Code must be created before any further programming.
Max User Codes = 250 with Network Module.
YRD246 Max User Codes = 25 without. YRD446 Max User Codes = 12 without.

1

Creating Master PIN Code

Creating a Master PIN Code must be performed upon installation or after resetting the lock to factory default. Programming and use of lock is not possible until this step has been successfully completed.

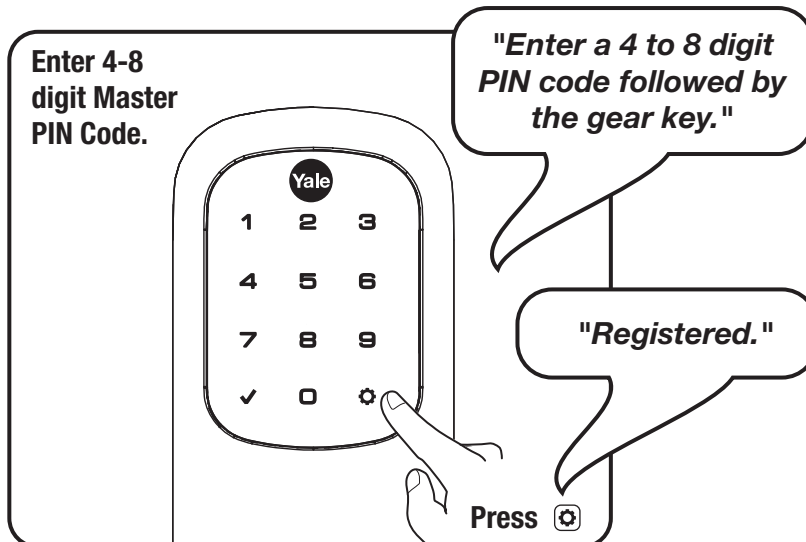
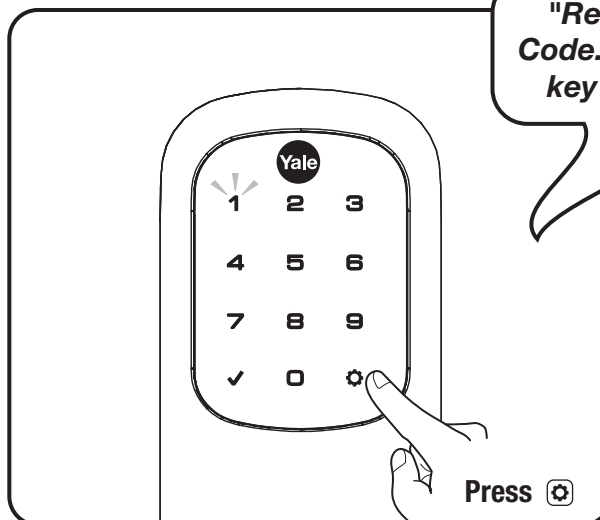
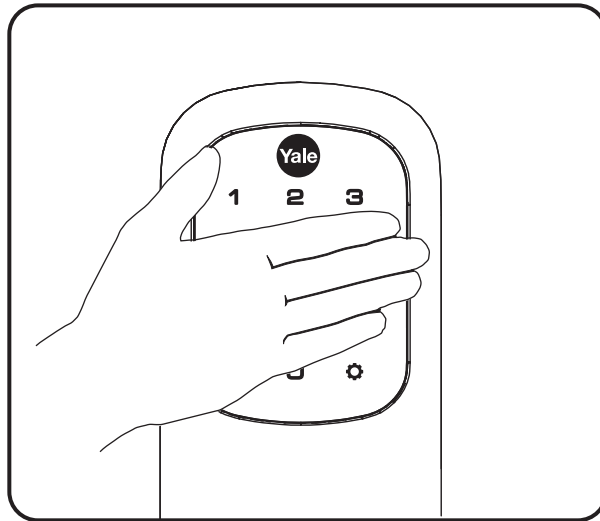

2

Creating User PIN Codes

Master PIN code must be created first.

*Max User Codes = 250 with Network Module. YRD246 Max User Codes = 25 without.

YRD446 Max User Codes = 12 without.

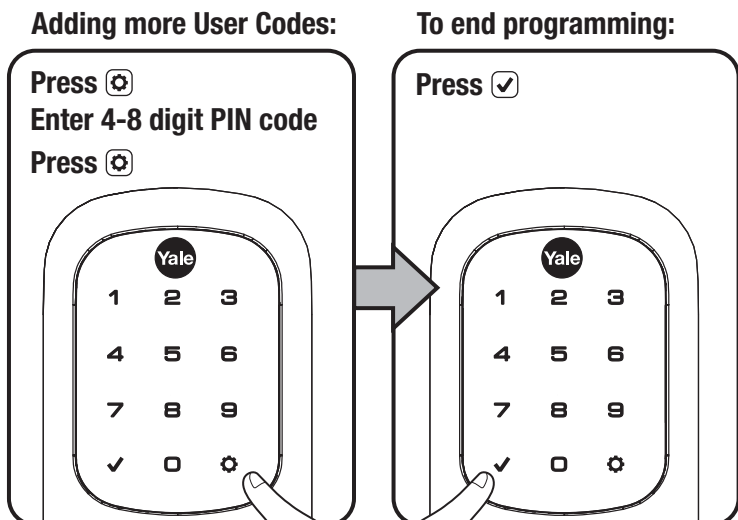
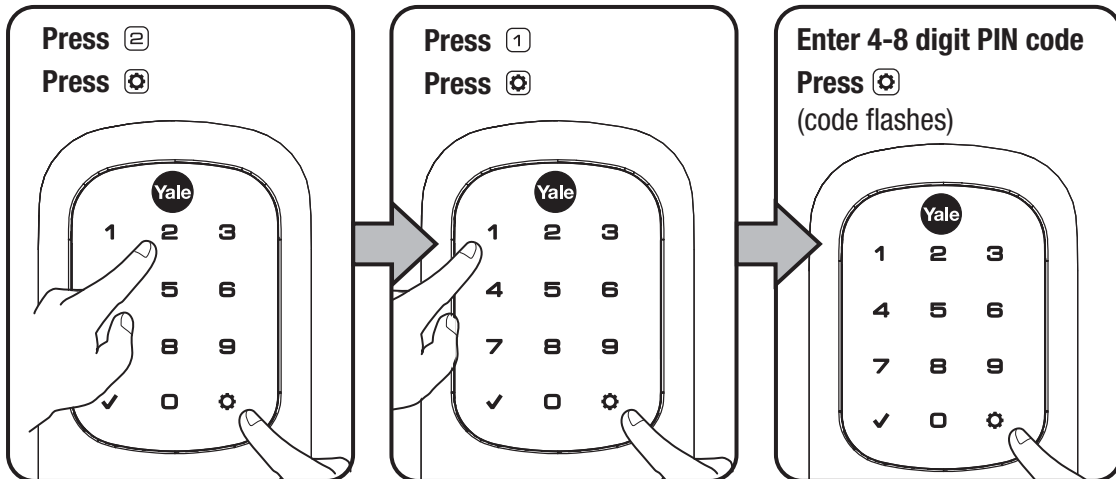
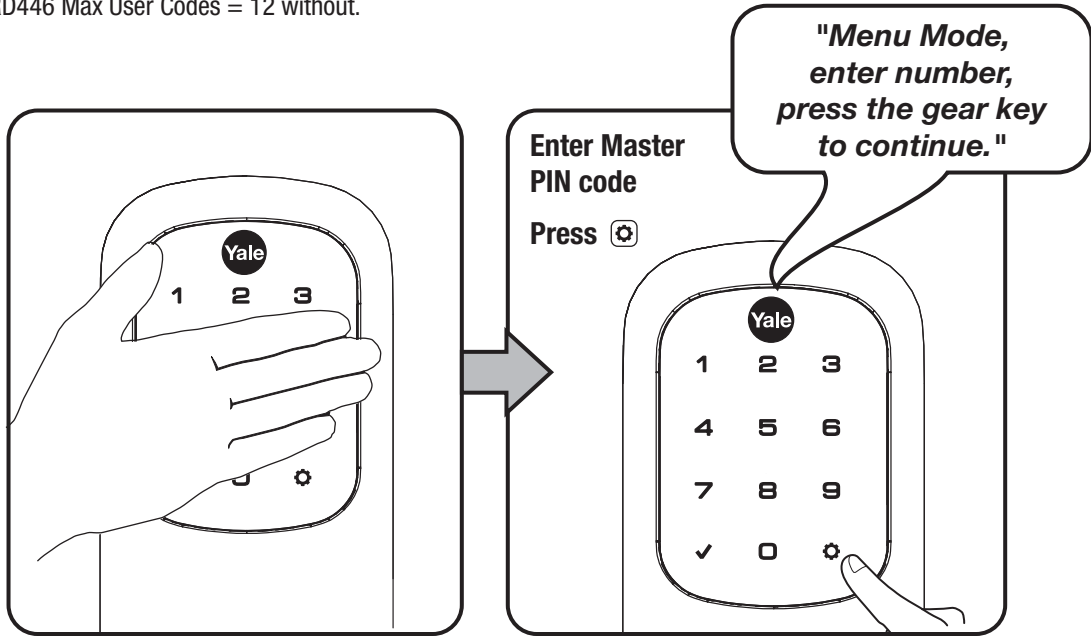

Resetting Lock to Factory Default

When lock is reset to factory defaults all user codes (including the Master PIN code*) are deleted and all programming features are reset to original default settings (see below).

1. Remove the battery cover and batteries.
2. Remove the interior escutcheon to access the reset button.
3. The reset button (see image at right) is located beside the PCB cable connector.
4. While pressing the reset button (minimum of 3 seconds) reinstall batteries. Release reset button.
5. Replace battery cover.

Upon reset, Master PIN Code creation is the only option available and must be performed prior to any other programming of the lock.

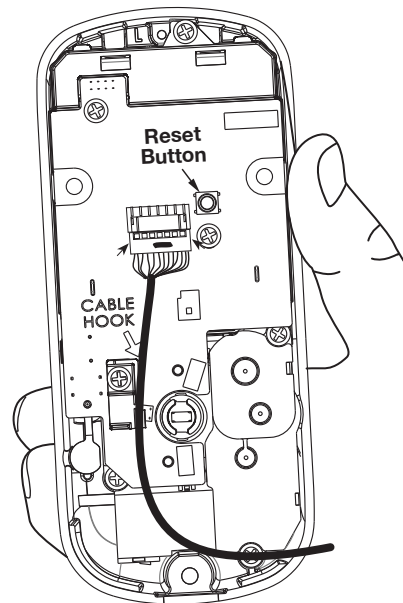

Interior Escutcheon

Factory Settings

Settings	Factory Setting
Master PIN Code	Registration <i>required</i> *
Automatic Re-lock	Disabled
Inside Indicator Light	Disabled (Off)
One Touch Locking	Enabled
Privacy Button Setting	Disabled
Volume Setting	Enabled (Low)
Language Setting	English
Lockout Mode	Disabled
Automatic Re-lock Time	30 Seconds
Wrong Code Entry Limit	5 Times
Shutdown Time	60 Seconds

*The Master PIN code must be registered prior to any other programming of the lock.

Definitions

All Code Lockout Mode: This feature is enabled by the Master code. When enabled, it restricts all user (except Master) PIN code access. When attempting to enter a code while the unit is in Lockout, the RED locked padlock will appear on the screen.

Automatic Re-lock Time: After a successful code entry and the unit unlocks, it will automatically re-lock after thirty (30) seconds.

Inside Indicator Light: Located on the interior escutcheon. Shows active status (Locked) of lock and can be enabled or disabled in the **Advanced Lock Settings** (Main Menu selection #3).

Language Setting Mode: Choosing English (1), Spanish (2) or French (3) becomes the (default) setting for the lock's voice prompts.

Low Battery: When battery power is low, the Low Battery Warning indicator flashes RED. If battery power is completely lost, use the 9Volt battery override. To use the 9V battery override apply 9V battery, in either direction, to terminals below the touchscreen for backup power option. Wake up the lock and enter your pin code to unlock the door.

Master PIN Code: The Master PIN code is used for programming and for feature settings. **It must be created prior to programming the lock.** The Master code will also operate (unlock/lock) the lock.

Network Module Setting: With the optional Network Module installed, this setting becomes available thru the Main Menu (7) and allows the lock to connect with a network controller.

One Touch Locking: When the latch is retracted, activating the keypad will extend the latch (during Automatic Re-lock duration or when Automatic Re-lock is disabled). When One-Touch Re-lock is **not** in use (**disabled**), any valid PIN code will re-lock the lock.

Previous: While in Menu Mode, pressing this icon cancels the current operation and returns the user to the previous step.

Privacy Mode: Privacy mode is disabled by default. Enable Privacy mode by pressing the privacy button for 4 seconds to put the lock in do-not-disturb mode (all pin codes are disabled).

Shutdown Time: The unit will shutdown (flashing RED) for sixty (60) seconds and not allow operation after the wrong code entry limit (5 attempts) has been met.

Tamper Alert: Audible alarm sounds if attempting to forcibly remove outside lock from door.

User PIN Code: The User code operates the lock. Maximum number of user codes is 250 with Network Module; without Network Module, maximum is 25 user codes. Note: When deleting User PIN code(s), screen will display User Number (not PIN code) being deleted.

Volume Setting Mode: The volume setting for PIN code verification is set to **Low (2)** by default; otherwise it can be set to **High (1)** or **Silent (3)** for quiet areas.

Wrong Code Entry Limit: After five (5) unsuccessful attempts at entering a valid PIN code, the unit will shut down and not allow operation.





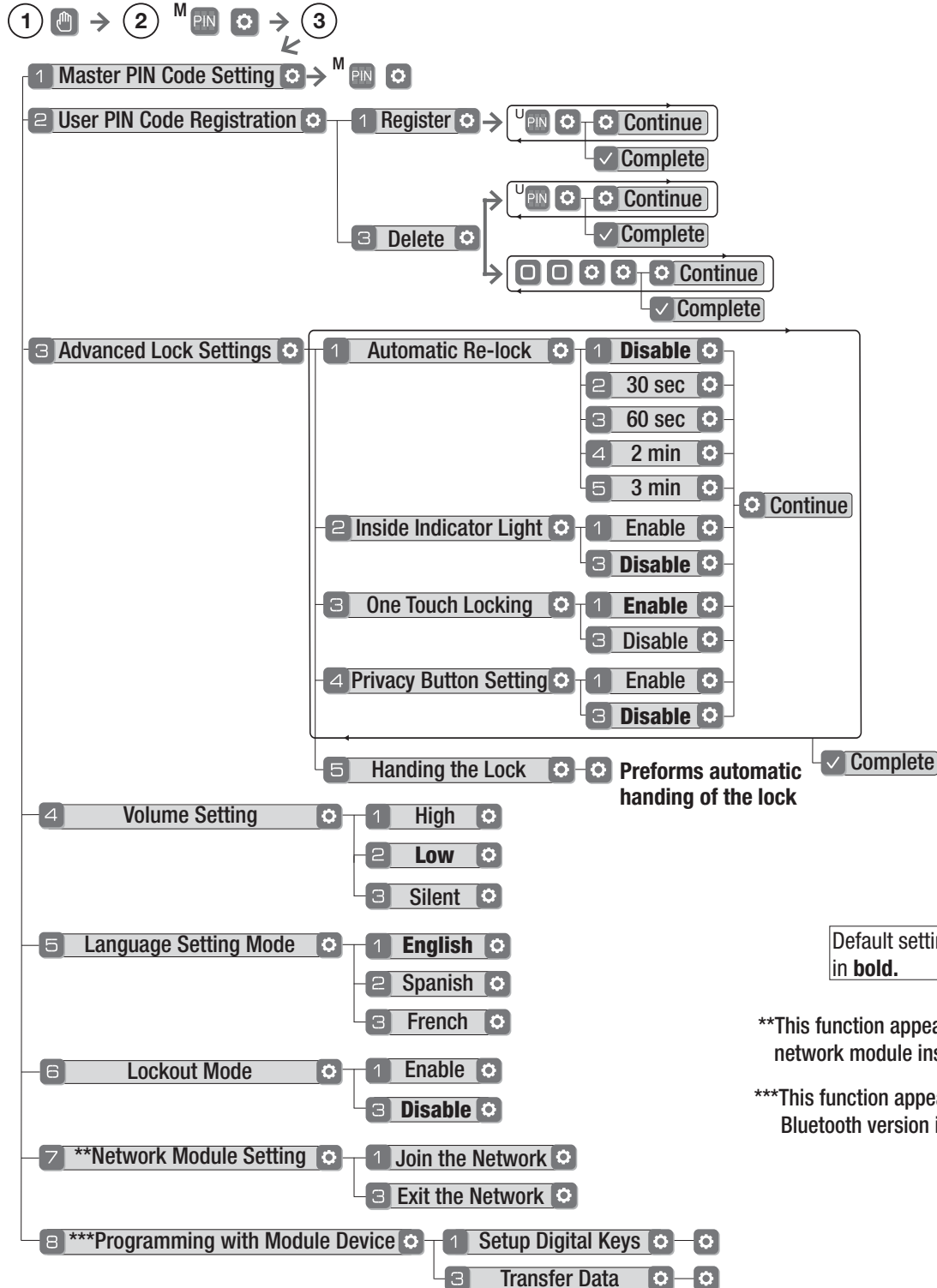

Feature Programming Through Menu Mode Using Master PIN code*

1. Touch screen with back of hand or palm to activate.
2. Enter 4-8 digit master PIN code* followed by key.
Lock Response: "Menu mode, enter number, press key to continue."
3. Enter digit corresponding to the function to be performed followed by the key.
Follow the voice commands.

*The Master PIN code must be registered prior to any other programming of the lock.



Programming Troubleshooting

Lock does not respond – door is open and accessible.	<ul style="list-style-type: none"> • Touchscreen becomes active when pressed w/whole hand. Use a larger area of the hand or fingers and verify contact with at least 3 areas. • If touchscreen numbers are visible, check to see if they respond when pressed. • Check batteries are installed and oriented correctly (polarity) in the battery case. • Check batteries are in good condition; replace batteries* if discharged. • Check to see if touchscreen harness is fully connected and not pinched.
Lock does not respond – door is locked and inaccessible.	<ul style="list-style-type: none"> • Batteries may be completely discharged. • Apply 9V battery to terminals below the touchscreen for backup power option.
Unit is on for a while then shows no reaction. Lights dim.	<ul style="list-style-type: none"> • Batteries do not have enough power. Replace batteries*.
Unit chimes to indicate code acceptance, but the door will not open.	<ul style="list-style-type: none"> • Check the door gaps for any foreign objects between door and frame. • Check that the wire harness is firmly connected to the PCB.
Unit operates to allow access, but will not automatically re-lock.	<ul style="list-style-type: none"> • Check to see if Auto Re-lock Mode is enabled. • Disable Auto Re-lock Mode to lock the door (automatically). • If low battery indicator is lit (see below), change batteries*.
PIN codes will not register.	<ul style="list-style-type: none"> • PIN codes must consist of 4 to 8 digits to register. • The same PIN code cannot be used for multiple users. • Registration/management of PIN codes is set by the authority of the Master Code, which is set first. • Contact the Master user. • User codes must be entered within 5 seconds (while touchscreen is active) or process will have to be restarted. • Check  or gear  cannot be used as part of the PIN code.
Upon entering a PIN code and pressing  key, the unit displays "invalid code" error or lock times out without responding.	<ul style="list-style-type: none"> • Lockout Mode is enabled. • Only the Master can enable/disable Lockout Mode. • Contact the Master user.
Upon entering a PIN code and pressing the  key, the red padlock icon appears and there are different tones.	<ul style="list-style-type: none"> • Check to see if the lock is set to Lockout Mode. • Setting/managing Lockout Mode is done through Master Code only. Contact the Master user.
The unit operates, but it makes no sound.	<ul style="list-style-type: none"> • Check to see if Silent Mode is enabled (see Feature #4).
The unit responds "Low Battery"	<ul style="list-style-type: none"> • This is the alert to replace the batteries. Replace all four (4) batteries* with new AA Alkaline batteries.
Upon entering a PIN code and pressing the  key, the unit responds "Wrong number of digits".	<ul style="list-style-type: none"> • The digits entered were incorrect or incomplete. Re-enter the correct code followed by the check  key.

* When batteries are replaced, Network Module locks have a real time clock that will be set through the User Interface (UI); it is recommended to verify correct date and time particularly those locks operating under Daylight Saving Time (DST).

** Network Module locks only

Hardware Troubleshooting

Cycle lock in both the locked and unlocked positions. If problems are found:

Door is binding

- a. Check that door and frame are properly aligned and door is free swinging.
- b. Check hinges: They should not be loose or have excessive wear on knuckles.

Bolt will not deadlock

- a. Check for sufficient clearance of the bolt within the strike-side jamb. Correct this by increasing the depth of the pocket for the bolt.
- b. Check for misalignment of bolt and/or strike which may be preventing bolt from properly entering the strike. With the door open, extend and retract the bolt; if it is smooth, check the strike alignment.

Bolt does not extend or retract smoothly

- a. Bolt and strike are misaligned, see above.
- b. Check the backset of door relative to adjustments already made to bolt.
- c. Verify proper door preparation and re-bore holes that are too small or misaligned.
- d. Verify keypad wire harness is routed under the bolt (see Fig. A).
- e. Verify bolt is installed with correct side up (Fig. A).

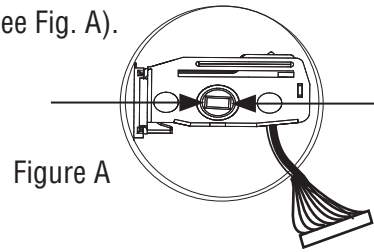

Keypad numerics are scrolling

Remove interior escutcheon and check to ensure that the wire harness lies flat against the back recessed area and is properly routed along the side of the escutcheon and tucked under the plastic cable guide.

NOTE TO INSTALLER AND CONSUMER

While Yale® has included several features to prevent lockout (9-Volt battery jumper, low battery warnings), it is still possible for a lockout situation to occur. Because this product does not have a mechanical override (a key), Yale® recommends to use this product in an environment where there are additional entry points into the dwelling.

FCC:*Class B Equipment*

This equipment has been tested and found to comply with the limits for a Class B digital device, pursuant to Part 15 of the FCC Rules. These limits are designed to provide reasonable protection against harmful interference in a residential installation. This equipment generates, uses, and can radiate radio frequency energy and, if not installed and used in accordance with the instructions, may cause harmful interference to radio communications. However, there is no guarantee that interference will not occur in a particular installation. If this equipment does cause harmful interference to radio or television reception, which can be determined by turning the equipment off and on, the user is encouraged to try to correct the interference by one or more of the following measures:

- Reorient or relocate the receiving antenna.
- Increase the separation between the equipment and receiver.
- Connect the equipment into an outlet on a circuit different from that to which the receiver is connected.
- Consult the dealer or an experienced radio/TV technician for help.

Warning: Changes or modifications to this device, not expressly approved by **Yale Security Inc.** could void the user's authority to operate the equipment.

Industry Canada:

This Class A digital apparatus meets all requirements of the Canadian Interference Causing Equipment Regulations.
Cet appareillage numérique de la classe A répond à toutes les exigences de l'interférence canadienne causant des règlements d'équipement.

Yale Locks & Hardware

Product Support Tel 800.810.WIRE (9473) • www.yalelocks.com

Yale Locks & Hardware is a division of Yale Security Inc., an ASSA ABLOY Group company.

Yale® and Yale Real Living® are registered trademarks of Yale Security Inc., an ASSA ABLOY Group company.

Copyright © 2016, Yale Security Inc., an ASSA ABLOY Group company.

All rights reserved. Reproduction in whole or in part without the express written permission of Yale Security Inc. is prohibited.

YALE, with its unique global reach and range of products, is the world's favorite lock
–the preferred solution for securing your home, family and personal belongings.

ASSA ABLOY is the global leader in door opening solutions,
dedicated to satisfying end-user needs for security, safety and convenience.