

smooth B2S

**ACTIVE IRONING BOARD WITH INTEGRATED
STEAM BOILER AND PROFESSIONAL IRON**



INSTRUCTION MANUAL

Before using this appliance, please read this instruction manual and keep it for future reference.

IMPORTANT SAF

SAVE THESE INSTRUCTIONS

Dear Customer,

We are delighted that you have purchased the Euroflex Smooth Active Ironing Board (B2S). Through proper assembly, use and maintenance the board will provide excellent ironing results for a long time. Before using this ironing system for the first time, please read carefully through the instructions in this manual and store them for future reference. These instructions are to accompany the appliance when it is used by another person who is unfamiliar with its operation or when ownership is transferred to another person. The manufacturer, importer and the distributor assume no liability in the event that the information in these instructions has not been strictly followed.

GENERAL SAFETY WARNINGS

- This appliance is solely for household domestic use.
- If the electrical cord is damaged, it must be replaced by the manufacturer or an authorised service agent in order to avoid a hazard.
- Do not use the board if visible damage is present. In this case get it checked by an authorised technical service center before using it again.
- Children should be supervised to ensure that they do not play with the appliance or its cord.
- This appliance should not be used by children and persons with reduced physical, sensory or mental capabilities.
- Children should not play with the appliance.
- Cleaning and user maintenance should not be carried out by children without supervision.
- This appliance must not be left unattended while it is connected to the power supply.
- The plug must be removed from the socket-outlet before the water reservoir is filled with water.
- The ironing board must be rested and used on a stable surface.
- When placing your iron on its stand, ensure that the surface on which the stand is placed is stable.

ETY INFORMATION

- This appliance is not to be used if it has been dropped, if there are visible signs of damage or if it is leaking.
- Keep the appliance and its cord out of reach of children when it is in operation or cooling down.
- The symbol 5041  relates to IEC 60417-1 and warns operators that surfaces are liable to get hot during use!
- This appliance complies with European Directives regarding “electromagnetic compatibility” and “Electrical product safety”. The appliance carries CE marking.

IMPORTANT NOTICES

- **WARNING!** If neither of the suction or blowing function is active, use the iron in dry-ironing mode (without steam) to avoid condensation inside the board.
- Repairs should be carried out solely by personnel authorised by the manufacturer. Equipment repaired by personnel who are not authorised to do so, represent a risk and, as such, are not covered by the warranty.
- The manufacturer reserves the right to make changes to the design and features of the appliance without notice.
- Do not connect the appliance before having made sure that electrical voltage supply corresponds to the required voltage shown on the product.
- The electric socket should be earthed and equipped with a 10A automatic circuit breaker.
- Do not connect the appliance to the electricity power supply with an unsuitable multi socket or an unsuitable extension lead. These do not guarantee the required safety of the appliance (e.g. danger of over heating).
- Prior to using the appliance, make sure the iron is securely connected to the ironing board steam valve. Failure to secure the connection could potentially lead to steam escaping, and the risk of scalding.
- The manufacture, importer or distributor assume no responsibility for damage to property or injury to persons, in the event that this appliance is damaged as result of improper use or assembly; unauthorised repairs carried out or unauthorised spare parts have been used; and for not properly following the care and maintenance instructions found in this manual.

IMPORTANT SAF

SAVE THESE INSTRUCTIONS

- Do not expose the appliance to water, dampness or heat. Only use indoors, not intended for outdoor use.
- Use a dry or slightly damp cloth to clean this appliance.
- Use solely manufacturer-recommended accessories or spare parts.
- The steam released from the appliance is extremely hot. Both appliance and accessory tools may scald. Avoid direct contact. The steam symbol  (symbol 5597 relative to IEC 60417-1) warns operators that there is the risk of scalding!
- Do not iron without the ironing board cover. The ironing board reaches potentially high temperatures, do not touch under any circumstances. High temperatures may potentially scald.
- Keep the appliance in a safe dry place (not outdoors) and out of the reach of children when not in use.
- Do not pull on the electrical cable. Do not use the cable to move the appliance. Do not exert undue pressure on the cable (i.e. when closing a door). Avoid any contact with sharp edges and corners. Keep the cable away from hot surfaces.
- No parts which are connected to an electrical power supply (switch, plug, electronic components, etc) should come in contact with water.
- Disconnect the appliance from the power supply prior to any maintenance or cleaning operations. Always allow the appliance to completely cool down.
- Remove the power supply in the event the appliance remains unattended for a long period of time.
- Loosen the security cap only when the steam in the boiler has been released by holding down the steam supply button (10), and the appliance has been turned off and completely cooled.
- Boiler filling should only be carried out with water that is free of additives, perfumes, or any other chemical substances.
- Do not overturn or lean the appliance unduly to one side.
- Do not point the jet of steam in the direction of persons, animals or plants.
- Do not point the jet of steam in the direction of electrical or household appliances.
- Do not insert any object in the various openings and do not use the appliance if any opening is obstructed.
- Do not use the appliance with wet hands or bare feet.
- Do not use the appliance when close to flammable or explosive substances.

ADVICE ON DISPOSAL

1. When this crossed-out bin symbol appears on a product it means that the product is covered by European Directive 2002/96/EC
2. All electrical and electronic products should be disposed of separately from the municipal waste stream via specific collection facilities designated by the government or the local authorities.
3. Proper disposal of your old appliance will help prevent potential negative consequences for the environment and human health.
4. For more detailed information about disposal of your old appliance, please contact your municipality, the waste disposal service or the shop where you purchased the product.



INDICATIONS OF USE

This manual can not take into account every possible use. For further information or for any problems that are not covered in detail in this manual, please contact the Service Center or retailer. **Keep this manual in a safe place for future reference .**

Destroy all plastic bags and packaging material, they can be a risk for children!

NOTE: Keep the packaging for possible future transport (eg relocations, repairs, etc.)

Attention: the photographs and/or drawings in this document are for illustrative purposes only. Actual appliance and the accessories may vary due to product enhancement.

Safety Informations in Digital Format: www.plastecs.it/warning



PRODUCT OVERVIEW

- | | |
|---|---|
| 1. Power ON-OFF button | 12. Iron soleplate |
| 2. Power Indicator Light | 13. Board height adjustment lever |
| 3. Low water warning light | 14. Iron steam socket |
| 4. Steam ready indicator light | 15. Iron steam/power cord |
| 5. Function switch: blowing position | 16. Iron cord support |
| 6. Function switch: suction position | 17. Filler Bottle |
| 7. Mode switch: synchro selection | 18. Power supply cable |
| 8. Mode switch: continuous selection | 19. Safety hot iron protection cover |
| 9. Power supply socket for detachable cable | 20. Iron rest pad |
| 10. Steam supply button | 21. Boiler cap fitted with safety valve |
| 11. Iron indicator light | |

BEFORE USE

Before starting the appliance for the first time, always remember that an improper use, assembly or maintenance can be hazardous. Please, carefully read the instructions on page 2,3,4,5.

1 PREPARE YOUR IRONING BOARD

POSITIONING

When setting up the ironing board please note the following:

- Place the ironing board on a flat, even, dry surface, near an earthed power socket
- Position the ironing board securely so that nobody can knock it over or get hurt.
- Never put the appliance on or near warm surfaces or near flames
- Use the appliance indoors only.
- To avoid scalding, keep the appliance away from children.
- Use only the correct extension cables in accordance with the advice given on page 2,3,4,5; pay attention not to trip over the cord.

Put up the ironing board as follows:

- Place the ironing board upright on the floor (steam generator downward).
- Hold the end of the ironing board with one hand.
- With the other hand hold the upper part of the ironing board legs.
- Firmly pull the ironing board wide apart (1) until the adjustment height device locks in place (2).
- Place the ironing board in a horizontal position (3).

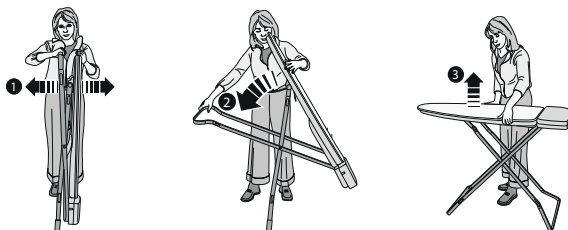

Note: Be careful that the feet of the ironing board don't slip on smooth floors while opening/closing the ironing board.

To assemble the iron rest pad proceed as follows:

- Pull out the metal frame from the rear part of integrated steam generator.
- Put the rest pad on the metal frame following the instruction on it's reverse side.
- Press the rest pad hard on the metal frame to ensure it is fixed properly.

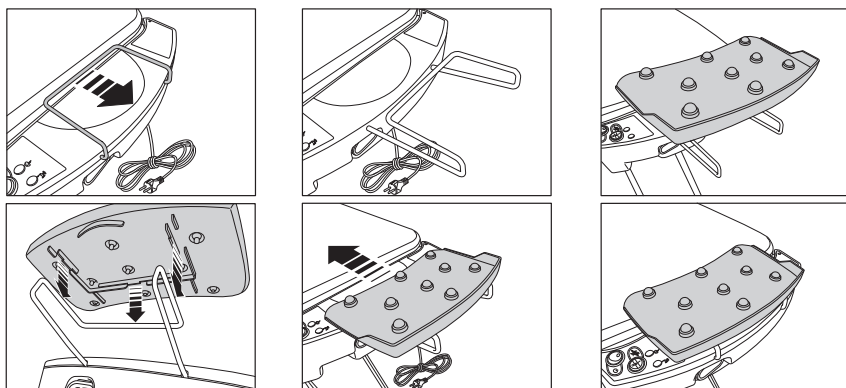

Insert the iron cord support in one of the small holes on each side of the ironing board and hang the iron steam cord. The iron cord support keeps the iron cord away from the surface of the board while ironing to avoid the cord moving or dragging the garment. The iron cord support also prevents “wear and tear” of the iron cord due to rubbing against the edges or surface of the board.

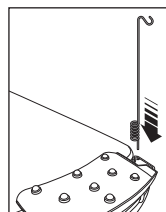

PREPARE YOUR IRONING BOARD

- Remove the iron from the iron protection cover.
- Plug the iron cable into the board steam socket.
- Put the iron (soleplate down) on the rest pad.

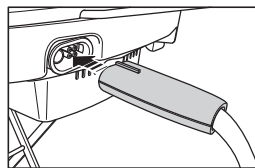

FILL THE TANK WITH WATER

- Ensure that the electrical cable is disconnected from the power socket.
- Slide the iron rest pad out horizontally to access the boiler cap.
- Unscrew and remove the safety boiler cap carefully, ensuring that no steam is present.
- Fill the bottle with ordinary tap water.
- Put the bottle into the hole for filling the steam generator tank and push it down to release the water to go in.
- Carefully screw in the safety cap without forcing it too much (tightening too hard is not necessary and may cause the gasket to wear out).
- Close the iron rest pad. Iron only when the iron rest pad is in the closed position.

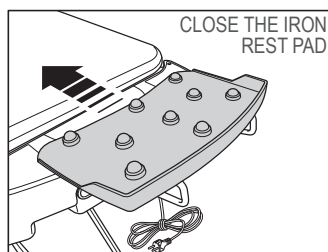
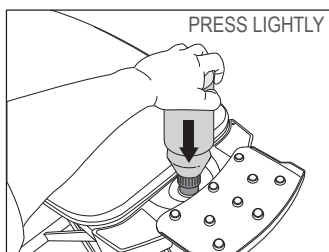
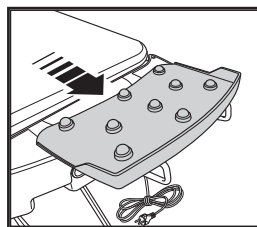

Important! The maximum capacity of the steam generator is 0.8L. Do not forget that residual water is always left in the tank. When water is poured, air bubbles in the filling-hole of the steam generator can hinder the subsequent filling. Therefore, we recommend that you slightly move the bottle from side to side during filling. Never fill the steam generator directly from the tap: spilled water could cause a short circuit!

Information about the water

This iron works with **ordinary tap water**. Decalcified water of any kind or water from tumble-dryers is not suitable, since it may be very corrosive. **Never use water treated with filter cartridges**, since the residues (e.g. particles of activated carbon) may block the mechanical parts of the appliance. Never add in perfumes, oils, starch into the water. Water with additives may damage the steam generator leaving you with subsequent costs of cleaning and service. Hard water and/or a frequent use may cause the formation of scale deposits in your steam generator. If you wish to slow down the scale forming, we recommend to regularly rinse out your steam generator (see maintenance, page 14) or use distilled water.

This ironing board comes with a steam generating unit and a steam iron with professional-style soleplate offering several advantages.

- Unlike a “normal” iron, an iron with a professional-style soleplate has steam holes only at the tip and it emits a large amount of concentrated steam, which quickly removes wrinkles and creases in any fabric.

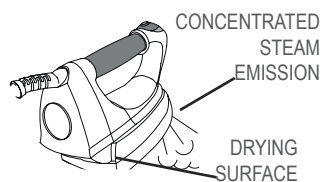

The strong concentrated steam easily penetrates through several layers of fabric to avoid having to iron the underside.

- The large smooth area underneath the steam holes is heated and it is used to dry and set the fabric.

This unique design based on commercial-style ironing systems reduces ironing time significantly while achieving professional ironing results.

2 IRONING BOARD START UP

- Plug the power supply cord into its socket.
- Place the iron on the iron rest pad.
- Switch the appliance on using the power on/off switch. The control warning light integrated into the iron will be on and remain on. It will switch off as soon as the iron soleplate reaches the working temperature. The iron heating time is about 3-5 minutes. The power on/off switch also activates the ironing board and the steam generator. During the heating phase the equipment may emit noises.

As soon as the “steam ready” indicator light is on, the pressure is reached in the steam generator and the iron is ready for use. The heating time for the steam generator is about 10 minutes and can be reduced by using lukewarm tap water.

No temperature regulation

The iron has been designed to offer you the peace of mind of steam ironing any type of fabric. You no longer have to worry about adjusting the temperature and/or the steam or arranging the garments according to the fabric type. When ironing very delicate fabrics, it's recommended to perform an ironing test on a hidden point of the garment or to cover the garment with a cloth. Alternatively, it is recommended to use the teflon insole (optional) to avoid any risk of damaging the garment.

STEAM IRONING

- To steam-iron push the “steam” button on the iron (10).

Warning! The steam emitted is very hot.

Danger of scalding!

Note! The appliance may give out some smoke when using it for the first time. It is a technical issue that will cease after a short while.

During use and after a long pause, direct the first steam jet toward the air or into a piece of cloth, but not on the garment to be ironed, so that any condensed water still in the iron may be expelled without staining the garment.

After the first steam jet the pressure slows down rapidly. It is not a fault. This is due to the emission of the air that entered the boiler during the filling.

Attention! To interrupt the emission of steam simply release the “steam” button on the iron. When you are not ironing place the iron (soleplate down) on the iron-rest mat.

After steam-ironing

- Turn off the appliance (on/off switch1).
- Pull the plug out of the mains socket (9).
- Let the appliance completely cool down.
- Remove the iron cord support.

Important! Store the appliance only when it has completely cooled down.

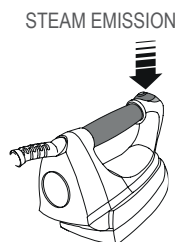

DRY IRONING

- Put the iron on the iron-rest mat (20).
- Turn the appliance on (power button 1). Simultaneously, the orange warming-up indicator light on the iron lights up (11). Later it switches off as soon as the soleplate reaches the required temperature. The iron reaches the required temperature after 3-5 minutes.
- To dry iron **DO NOT press** the steam button.

After dry ironing

- Turn off the appliance (on/off switch 9).
- Pull the plug out of the mains socket. Let the appliance cool down completely.

3 SUCTION/BLOWING FUNCTION AND HEATING OF THE BOARD

The suction absorbs the excess steam, which is no longer used after the ironing process. The suction helps hold the garment on the ironing surface and helps to dry the garment. Garment ironed with this board are ready to be placed straight in the wardrobe without further airing.

The heated ironing surface stays dry, and keeps the steam hot so that it passes through the board to be expelled without condensing.

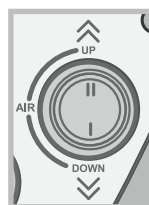

FUNCTION SWITCH

SUCTION FUNCTION

With the suction function, light fabrics (silk etc.) can be held in place on the ironing board, preventing them from slipping. The suction function cools and sets the fabric during ironing, guaranteeing no wrinkles.

- To activate the **suction function** set the selector switch on position “I” (6).

BLOWING FUNCTION

The blowing function allows you to iron on a pillow of air without applying downward pressure. This makes ironing of delicate items, or difficult areas (trousers folds, pockets, seams, difficult areas to reach), much easier and avoids the visible signs or seam crushing.

- To activate the **blowing function** set the selector switch on position “II” (5).

SYNCHRO MODE

In synchro mode the suction/blowing function is activated when you press the steam button on the iron (10).

- To activate the **synchro mode** set the selector switch on position “II” (7).



MODE SWITCH

CONTINUOUS MODE

In continuous mode the suction/blowing function is activated without interruption.

- To activate the **continuous mode** set the selector switch on position “I” (8).

Important! Do not rest the hot iron directly on the Ironing board. Always use the iron-rest mat included.

4 AFTER IRONING

- After use, leave the board open for 10 minutes to dry the cover and to avoid the formation of condensation in the board.
- Turn off the ironing board using the power on/off switch. (1)
- Remove the plug from the socket (9).
- Let the equipment cool completely.
- Remove the iron cord support.
- Place the iron on the iron rest pad.
- Unplug the iron/steam generator from the auxillary socket and remove it from the board.
- Fold the shelf back over the ironing surface.
- Wrap the power supply cord around two cord supports beneath the board.
- Hold the board leg with your foot to stop it skidding.
- Operate the height adjustment lever and close the board.

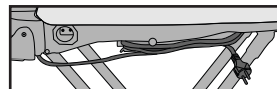

Note: do not entangle the power cord. Store the closed board in a vertical position with the folded shelf end towards the floor. Always ensure that the board does not skid and tilt. Store the appliance in a dry place and out of reach of the children.

5 MAINTENANCE

BOILER CLEANING (recommended every 6 months)

- Always disconnect the power supply cord and ensure that the equipment is completely cool and the boiler contains no water.
- Disconnect the iron from the steam supply.
- Slowly unscrew the safety cap and remove it.
- Incline the board (1) and unscrew the boiler unit. We recommend you begin carefully from the lower screws, making sure that the boiler unit does not fall.
- Using the bottle fill the boiler with 0.8 litres of water. Close the cap and shake vigorously then unscrew the cap and tip the liquid into the sink.
- Repeat the operation, two or three times.
- When you have finished reassemble the boiler unit to the board ensuring that it is properly connected.

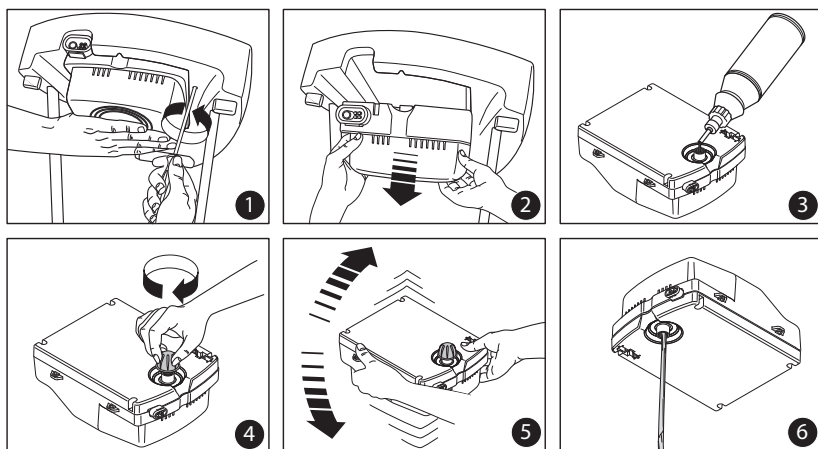

Note: If you have damaged the boiler, or it has developed a fault, disassemble it as described above and either take it or send it to an authorised repair centre.

Important!

Never pour any kind of detergents or decalcifiers into the generator. Never perform Maintenance when the steam generator is under pressure. Perform maintenance only when the equipment is completely cooled.

Changing the Cover

With continuous use, the cover which is fitted with a drawstring is subject to wear and should be replaced regularly. Due to the design of this ironing system which incorporates a heated ironing surface and to guarantee the correct performance of the product, we recommend that you use only Euroflex ironing board covers.

Metallised heat reflective covers and covers with thick lining are not suitable for this ironing system and may cause overheating of the suction motor.

Warning!

In case of failure due to faulty material or if damage results due to the appliance falling over or being dropped, immediately remove the plug from the socket. Repairs should be performed exclusively by an authorised Service Centre. Repairs performed by unauthorised personnel may cause serious hazards for users. No responsibility or liability is assumed for injury to persons or damage to property caused by repairs performed by unauthorised personnel or where parts have been used that are not approved by the manufacturer. In such cases the manufacturer's warranty is voided.

6 TECHNICAL DATA

Voltage:	220-240V ~ 50/60Hz
Rating:	1950W
Board dimension:	117 x 50 x 14 cm
Net weight:	14.6 kg
Cable length:	2.5 mt
Tank capacity:	0.8 L

Distributed by:

Echidna Sewing

56 Neumann Road
CAPALABA QLD 4157
PH 07 33903600

Email: support@echidnasewing.com.au

Imported by:

Euroflex Australia Pty Ltd

79 Furniss Road
DARCH WA 6065
AUSTRALIA
TEL: 08 9302 2526

Email: admin@euroflex.com.au

Website: www.euroflex.com.au



Manufactured by:

Plastecs SRL

Via dei Colli, 59
31058 Susegana (TV) - ITALY
Tel: +39 0438 453334

Email: info@plastecs.it

Website: www.euroflex-appliances.com