

Snubby Back-to-wall toilet suite

SNUBBY



- Rimless Flush
- Full Sweep action flush
- Soft close lid
- Non-marking surface
- 4 star water efficiency rating

Parts List

Description	Code
Pan	Snubby-P
Tank	Snubby-T
Seat	TSC
Bolt Kit	CTPFBB
Inlet Valve	TV.2-SIV
Donut Seal	TV.2-TPDS
Pan Connector	PC-60

WATER RATING
4 Star

- SNUBBY-GW
Gloss White
- SNUBBY-GB
Gloss Black
- SNUBBY-MB
Matte Black

SNUBBY

DIMENSIONS

UNIVERSAL INLET
Left and Right Bottom Feed

CONNECTIONS

ALLFIT
ALL-IN-ONE COMBINATION CONNECTOR

ALLFIT S-TRAP
60mm-225mm
This item comes included in box

IMPORTANT: Dimensions provided are as accurate as possible at the time of publication and may vary within a reasonable tolerance range. Measurements are subject to change or cancellation as products are improved. No responsibility is assumed for use of superseded or voided dimensions. Be sure to measure product before installation and visit the Propel Industries website for the most up to date measurements
Version Date: 25/10/2023



CHECK GOODS THOROUGHLY BEFORE INSTALLATION

Installation of received goods that are damaged, warped or faulty will void warranty. Ensure all items meet your plumbing requirements.

All installations should be carried out by a qualified tradesman in compliance with the National Plumbing & Draining Code or Local Authority Regulations, in accordance with AS/NZS 3500 series of standards and AS/NZS 6400. All Measurements are in millimeters and are subject to change without notice. For ceramic products, please allow +/- 10mm tolerance for manufacturing variance. Please refer to propelindustries.co.nz for the latest product specification.

S-Trap Installation

1. The S-pipe should be put into position and cut to suit your set out, then attached to the wall using the thread bolt and plate provided.
2. Now push the pan hard into position to ensure the ceramic outlet is pushed into the S-pipe by approx 50mm. This is so the rubber inside the S-pipe gets a good seal to stop water leaking.

PLEASE DO NOT SILICONE PAN TO FLOOR UNTIL TOILET HAS BEEN CHECKED FOR LEAKS.

Cistern Installation

1. Parts required to mount tank to pan.



2. Attach tank bolts to pan. Tighten from underneath.

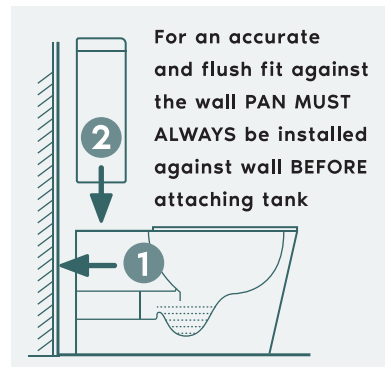

3. Ensure outlet rubber is fitted to tank.



4. Sit tank onto pan.



5. Use supplied bolts to fasten tank to pan.



NOTE: There should be no play or movement between the pan and the tank after you have tightened the screws.

PLEASE, MAKE SURE YOU DO NOT OVER TIGHTEN THE SCREWS AS THIS MAY CRACK OR DAMAGE THE WASHERS

Seat Installation

1. Open the box and check all components.
2. Insert the expansion fittings (4) into the seat bolt holes in the pan.
3. Assemble hinge fixings (3) and bolts (2) as shown in the diagram. Leave loosely attached.
4. Align the hinge housing of the seat with the hinge fixings and adjust the seat to desired position.
5. Remove the seat by depressing the release buttons and lifting upwards.
6. Tighten the bolts with a Phillips head screwdriver ensuring that the expansion fittings are secure. Put the decorative cap in the position then attach the seat on the hinges.

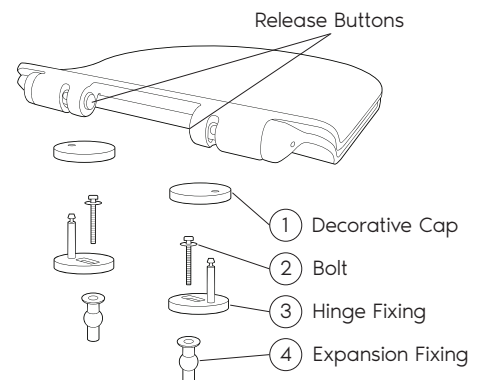

All installations should be carried out by a qualified tradesman in compliance with the National Plumbing & Draining Code or Local Authority Regulations, in accordance with AS/NZS 3500 series of standards and AS/NZS 6400. All Measurements are in millimeters and are subject to change without notice. For ceramic products, please allow +/- 10mm tolerance for manufacturing variance. Please refer to propelindustries.co.nz for the latest product specification.



WARNING

Do not use chlorine/chemical sanitisers in the cistern tank. Such use may result in damage to tank components and will void the product warranty.

Inlet Valve Service

1. Water Level Adjustment

Turn screw to raise/lower the float

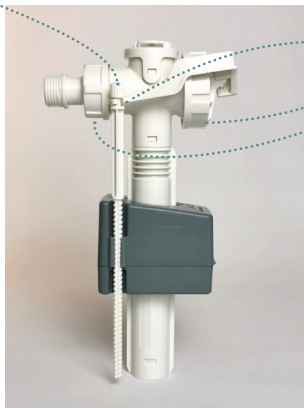

2. Cleaning the Diaphragm

It is possible for dirt/debris to prevent the valve shutting off. To remedy this the diaphragm may be cleaned as follows:

1. Unclip the float arm from the adjustment screw
2. Twist the plastic top-assembly firmly anti-clockwise and remove it from the valve body
3. Inspect both rubber diaphragm and valve seat
4. Rinse under running water to remove debris
5. Re-assemble in reverse order

Outlet Valve Service

Removal

Valve may be removed for service - twist to unlock

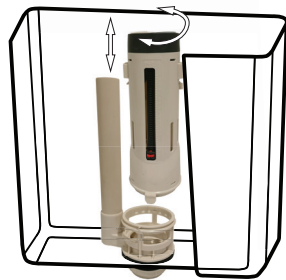

Assembly

Hoses are not shown on this diagram



Push Button Rod Settings

Button rods must be just clear of the valve pads

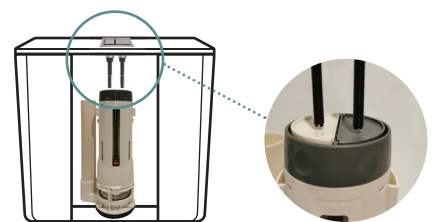

Button rods can be adjusted by screwing up or down

Ensure that buttons match valve pads

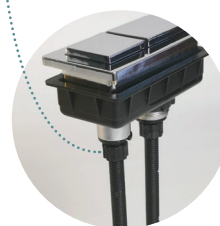

Full flush Half flush

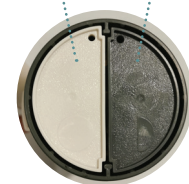

All installations should be carried out by a qualified tradesman in compliance with the National Plumbing & Draining Code or Local Authority Regulations, in accordance with AS/NZS 3500 series of standards and AS/NZS 6400. All Measurements are in millimeters and are subject to change without notice. For ceramic products, please allow +/- 10mm tolerance for manufacturing variance. Please refer to propelindustries.co.nz for the latest product specification.

Warranties

Warranty Periods

Applies to domestic and commercial uses of Propel Industries products, such as private dwellings and retirement villages as well as including, but not limited to: commercial food premises such as restaurants; commercial accommodations such as hotels; hospitals and healthcare facilities; public amenities; and industrial, laboratory and manufacturing facilities.

Parts List

TOILETS*	
Range	Warranty Period
Vitreous China	5 years replacement parts or products
R&T Cisterns (Tanks & Frames)	5 years replacement parts or products
R&T Cisterns (Valves)	5 years replacement parts or products
Accessories & Spare Parts	5 years replacement parts or products

*Excludes parts subject to wear and tear such as rubber seals. Labour is not included unless otherwise specified.



Warranty Conditions

- Installation has been carried out by a licensed plumber in accordance with the plumbing code of New Zealand.
- All maintenance and adjustments to the product after the installation have been carried out by a licensed plumber.
- No additives have been introduced to the cistern tank.
- Only mild household detergents and soft (non-abrasive) cloth has been used to clean the product.
- All goods of standard quality manufacture (excluding imperfections permitted within AS1976 - Vitreous China used in Sanitary Applications) will be credited or replaced by Propel Industries when advised within the warranty period, subject to prior inspection and agreement.
- Proof of purchase is required for warranty claims.

Warranty Limitations

To the extent permitted under the Trade Practices Act and other relevant legislation, Propel Industries liability is limited to:

- The cost of replacing the goods, or
- The cost of obtaining equivalent goods, or
- The cost of having the goods repaired
- Propel Industries is not responsible for any lack of operation or performance of goods (or any loss or damage) where goods are used or adapted for use with other goods not supplied by Propel Industries.
- It is the responsibility of the customer and installer before installation to ensure that all components are correct and free of obvious visible faults.
- Propel Industries is not responsible for the labour and rectification costs incurred in the above circumstance.

Conditions for On-Site Warranty Service Calls

Propel Industries will charge a service fee for each visit to an installation by its technician where it is determined that the fault is due to poorly executed or unlicensed installation work or where the product is not a genuine Propel Industries product or where the product is outside the warranty period. This may be paid in advance by credit card over the phone to a Propel Industries technician attending the site and will be refunded if the Propel Industries product is found to be at fault.

Cleaning & Care

- The toilet seat may be removed for cleaning - depress the release buttons and lift up.
- Clean only with a soft cloth or sponge using warm water and mild soap or detergent. Do not use any abrasive cleaning materials.
- Do not use any solvents or corrosive liquids.
- Note that the use of clip-on deodorisers will affect flushing performance on rimless suites.

For warranty support, please contact Propel Industries



P 0800 427 335 **E** orders@propelindustries.co.nz
www.propelindustries.co.nz

All installations should be carried out by a qualified tradesman in compliance with the National Plumbing & Draining Code or Local Authority Regulations, in accordance with AS/NZS 3500 series of standards and AS/NZS 6400. All Measurements are in millimeters and are subject to change without notice. For ceramic products, please allow +/- 10mm tolerance for manufacturing variance. Please refer to propelindustries.co.nz for the latest product specification.