

## Familia

### Installation manual

Dimensions:

120x180 cm

150x180 cm

150x200 cm

200x200 cm

200x250 cm

Handedness:

Right

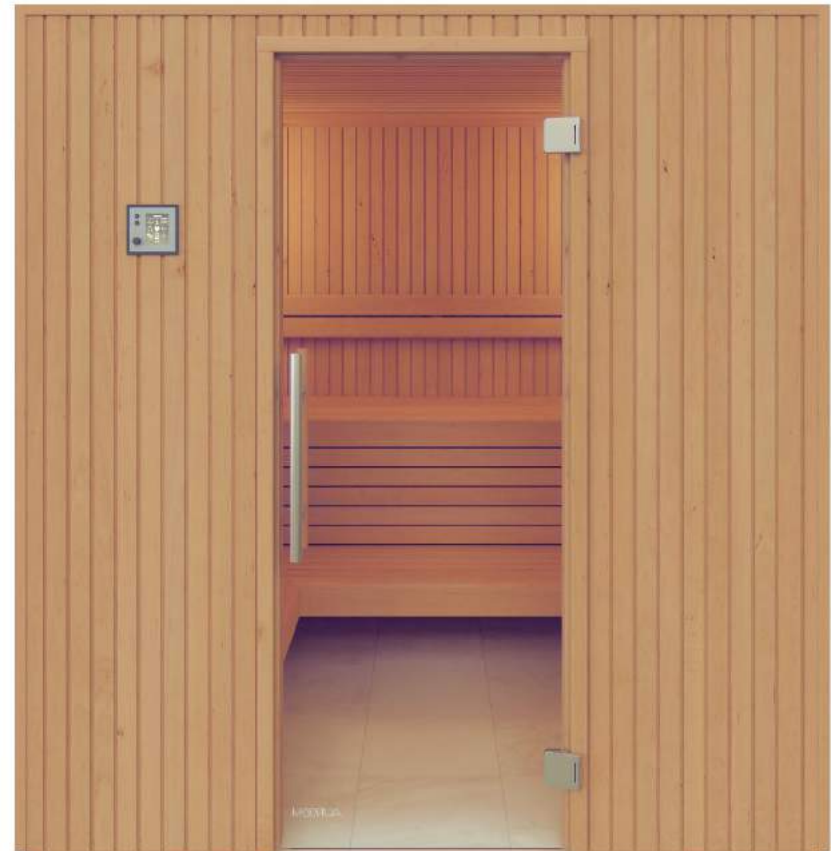

# Leave space for better assembly

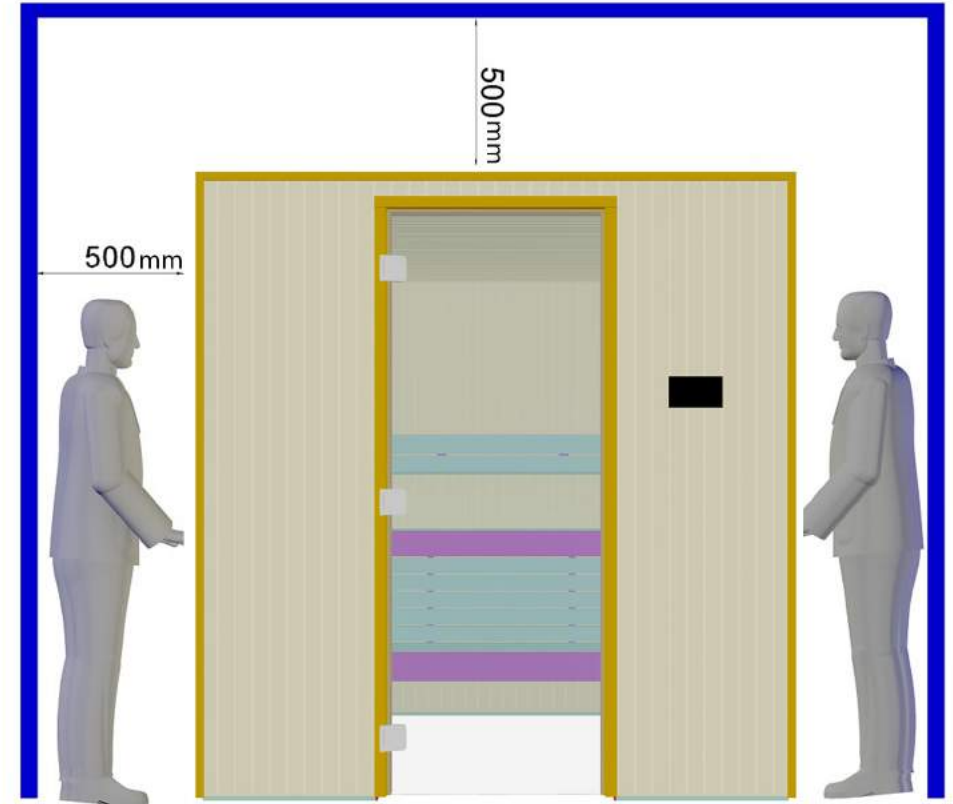
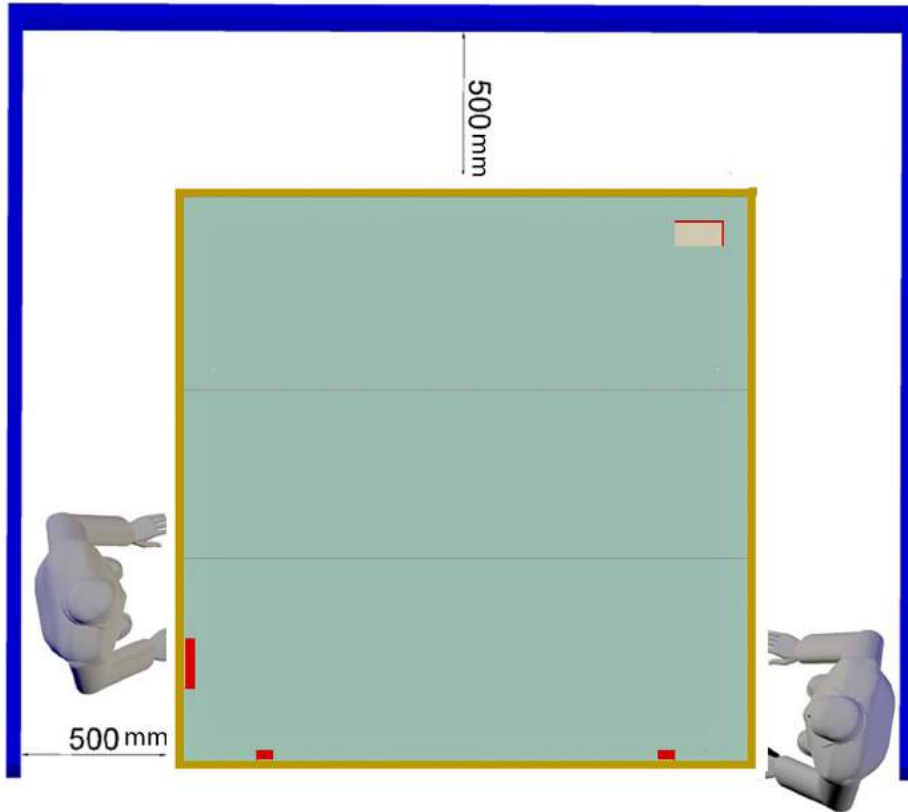

# Tools



# 1. Base frame

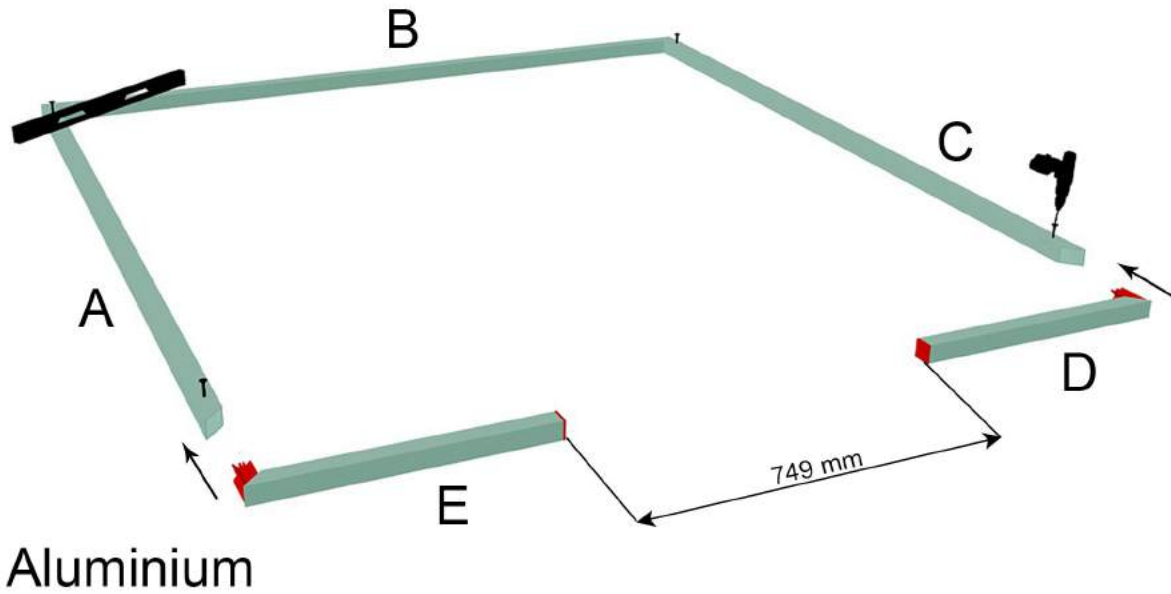

	A/C	B	D	E
120x180 cm	1160 mm	1760 mm	483 mm	483 mm
150X180 cm	1460 mm	1760 mm	483 mm	483 mm
150x200 cm	1460 mm	1960 mm	583 mm	583 mm
200x200 cm	1960 mm	1960 mm	583 mm	583 mm
200x250 cm	1960 mm	2460 mm	1083 mm	583 mm

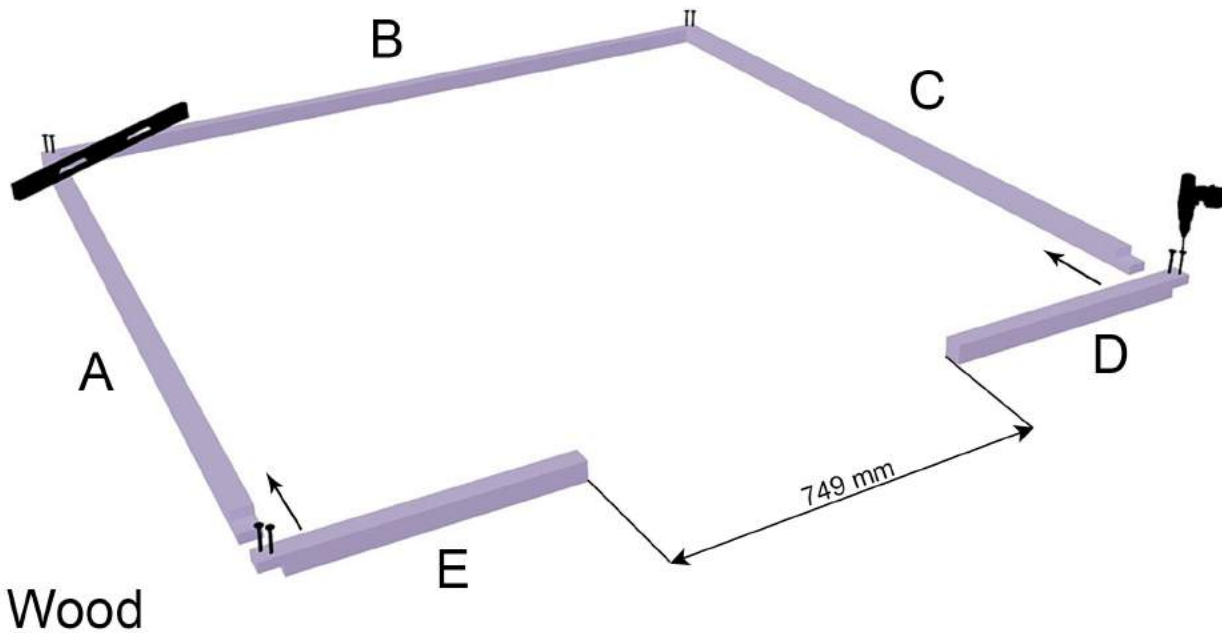

	A/C	B	D	E
120x180 cm	1160 mm	1760 mm	483 mm	483 mm
150X180 cm	1460 mm	1760 mm	483 mm	483 mm
150x200 cm	1460 mm	1960 mm	583 mm	583 mm
200x200 cm	1960 mm	1960 mm	583 mm	583 mm
200x250 cm	1960 mm	2460 mm	1083 mm	583 mm

## 2. Walls

Number of wall elements				
	A	B	C	D
120x180 cm	2	3	2	3
150x180 cm	2	3	2	3
150x200 cm	2	3	2	3
200x200 cm	3	3	3	3
200x250 cm	3	4	3	4

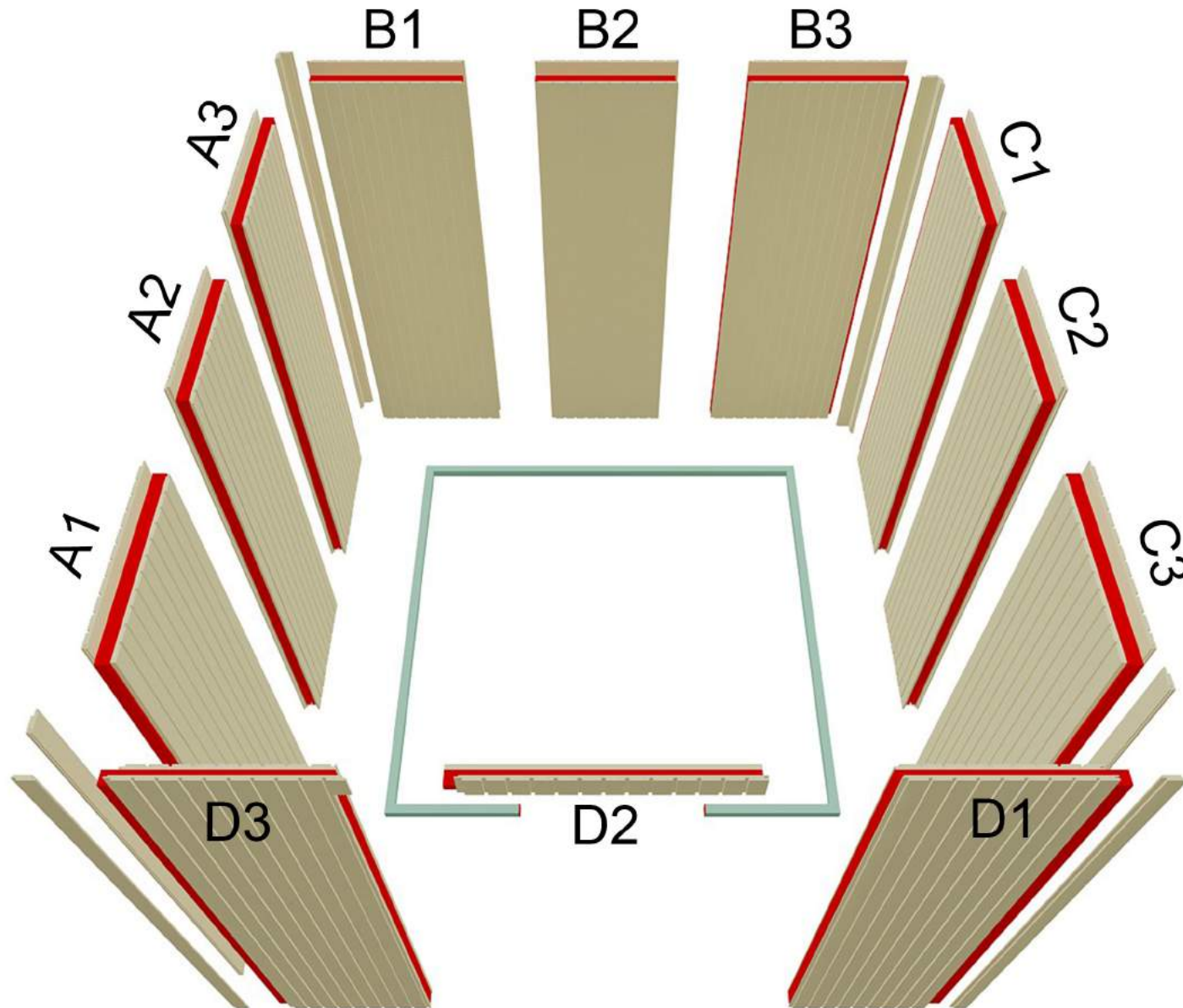

### 3. Multiclip closing system

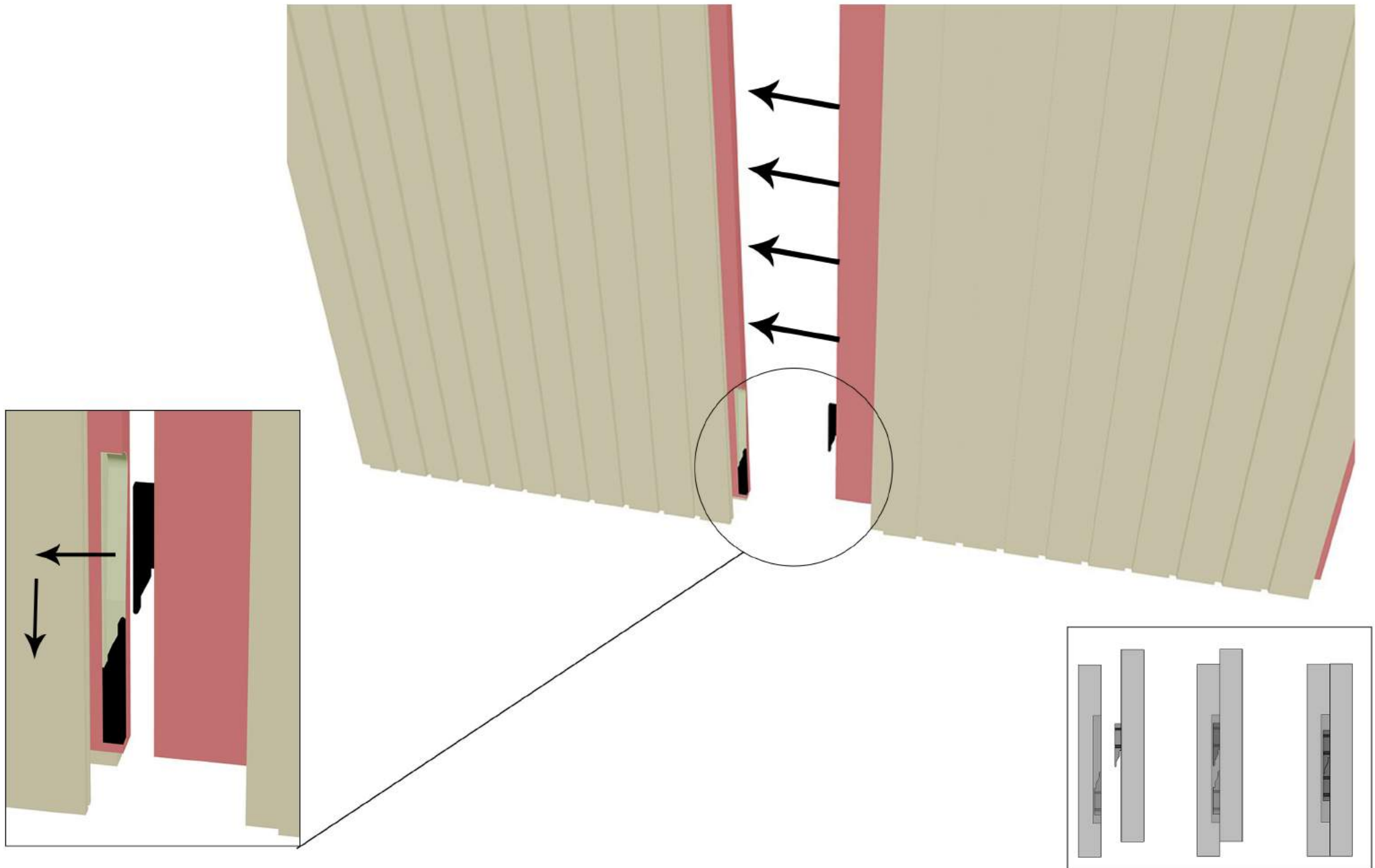

# 4. Fixing first corner walls

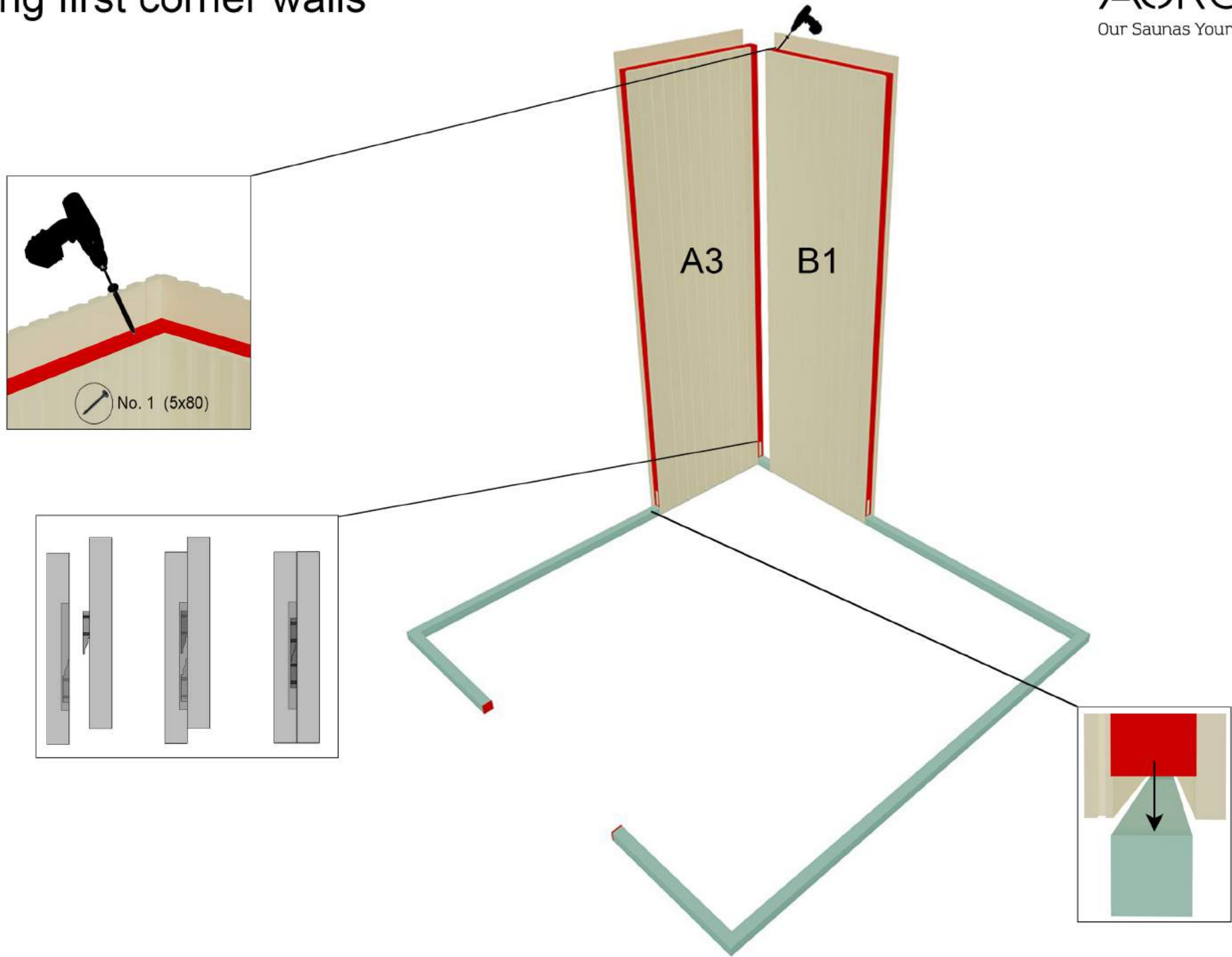

## 5. Fixing A1 & A2

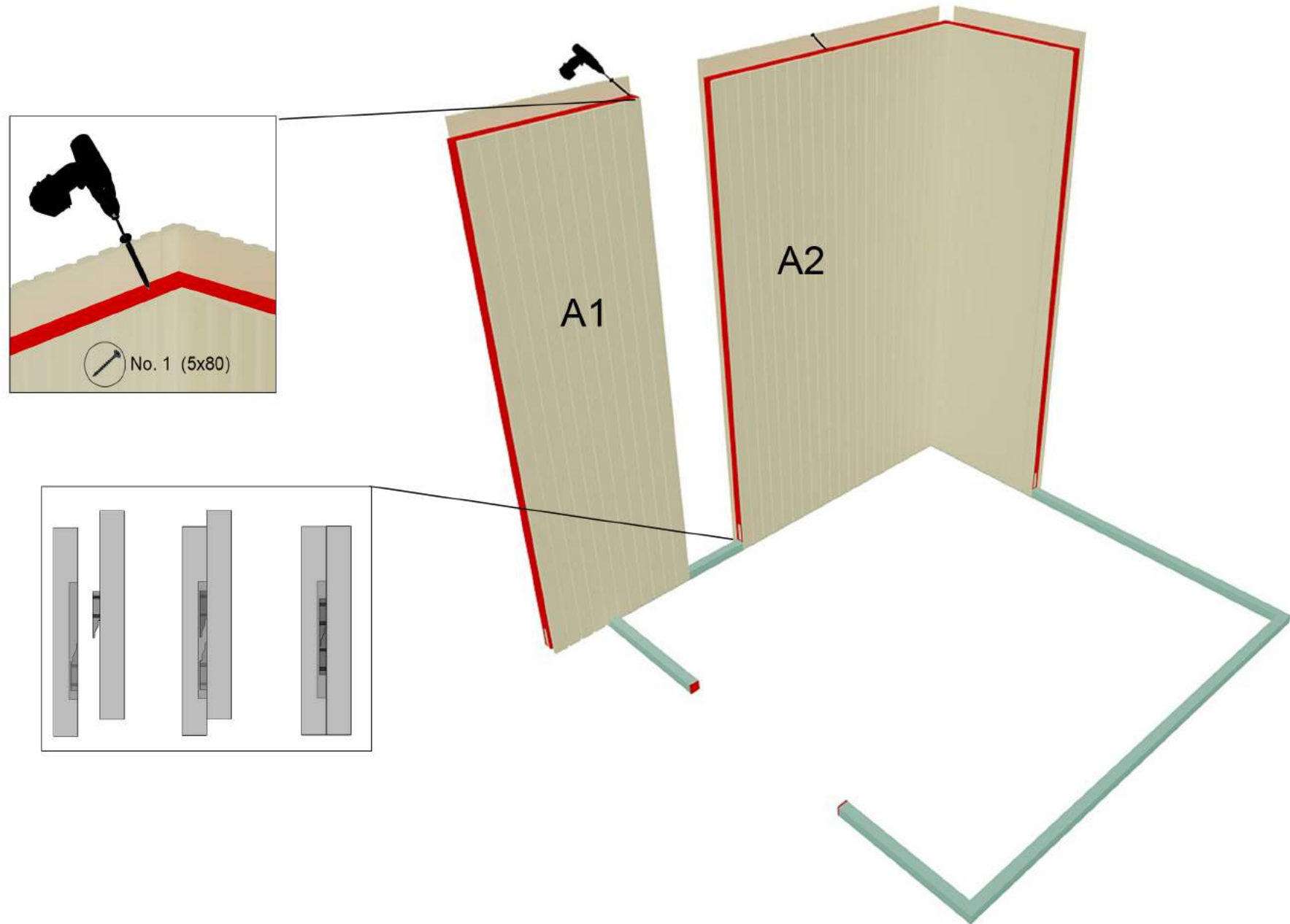



## 6. Fixing B2 & B3

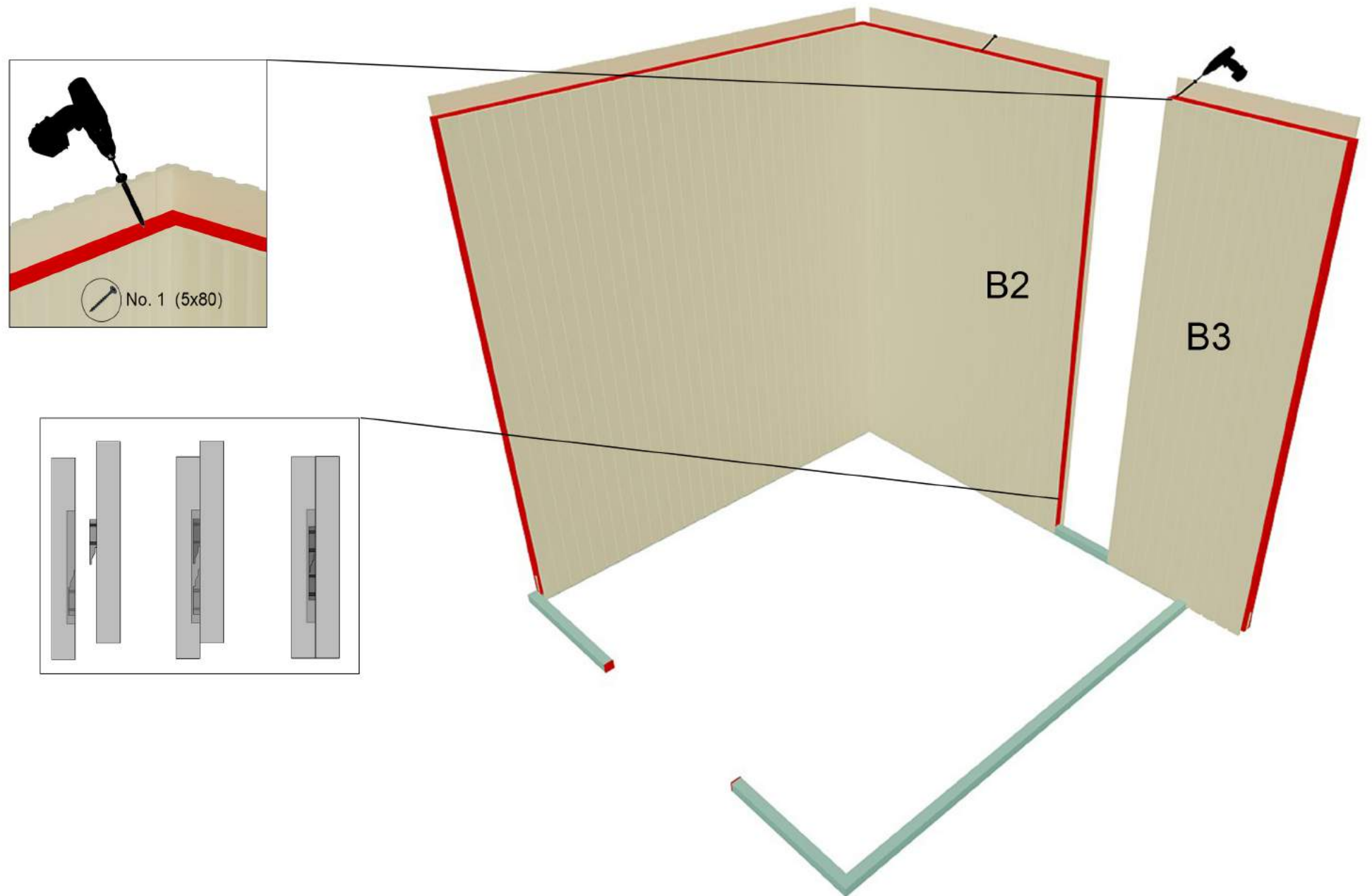

# 7. Fixing C walls

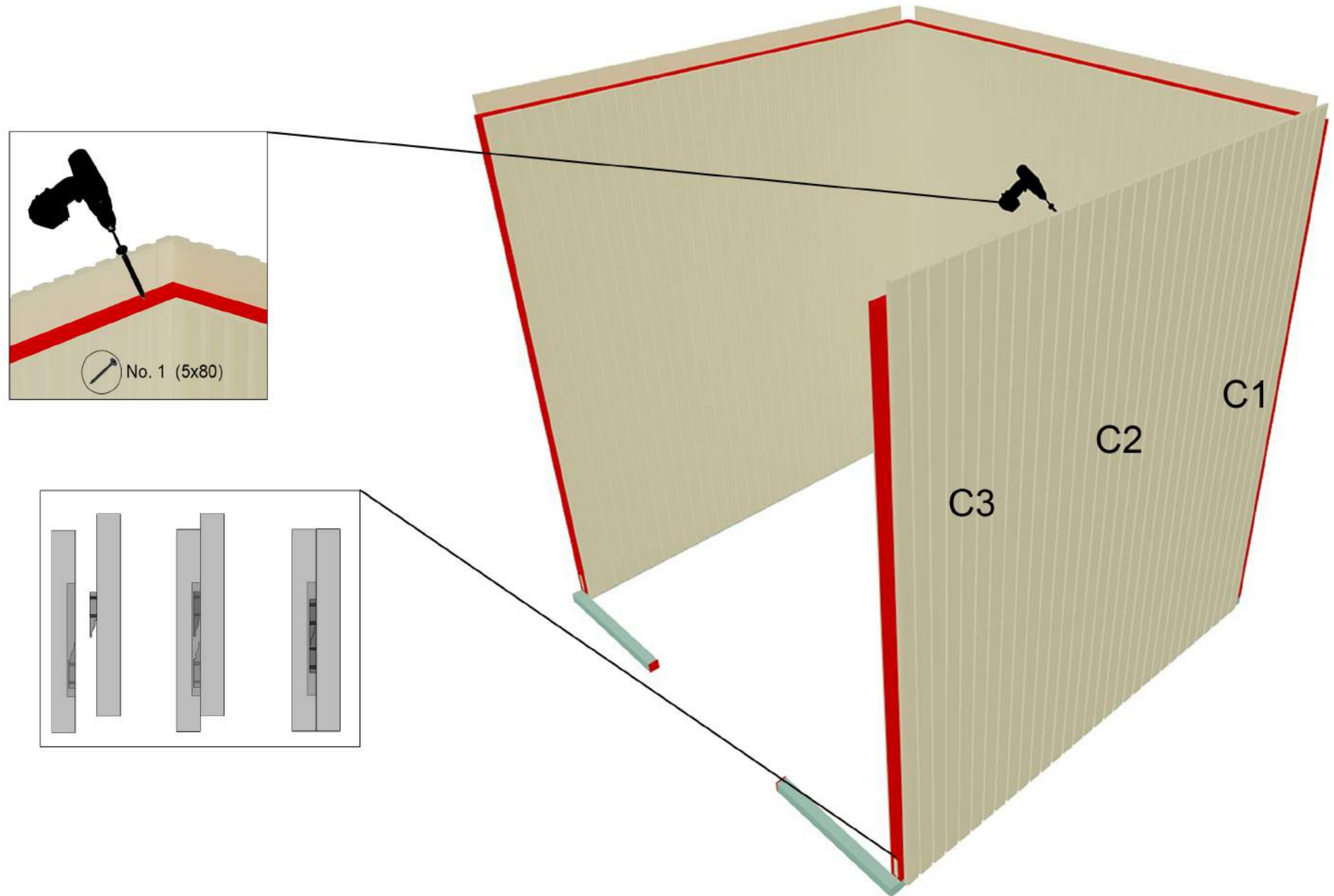

# 8. Support & glass removing

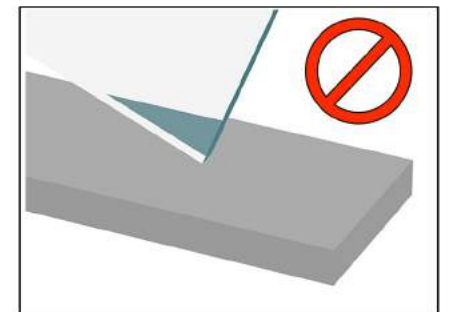
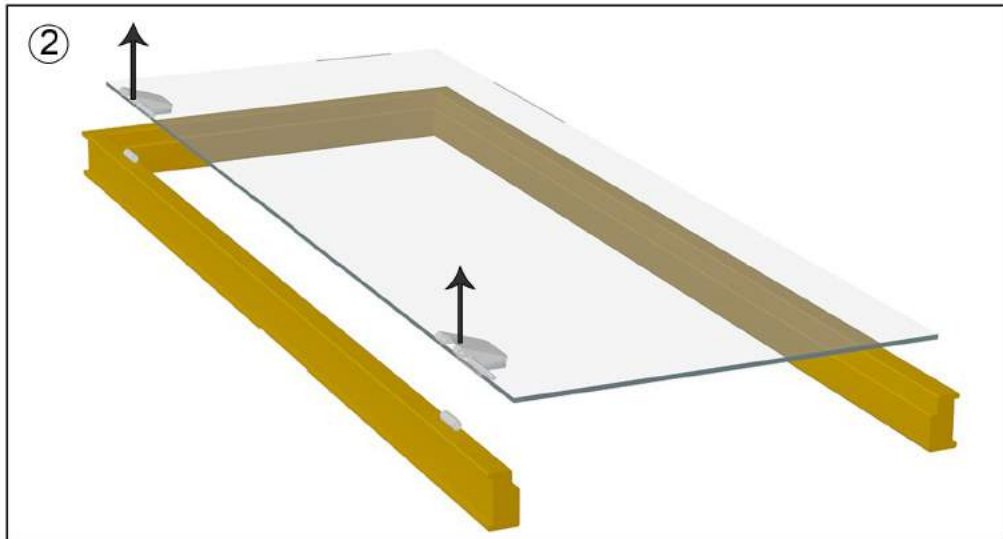
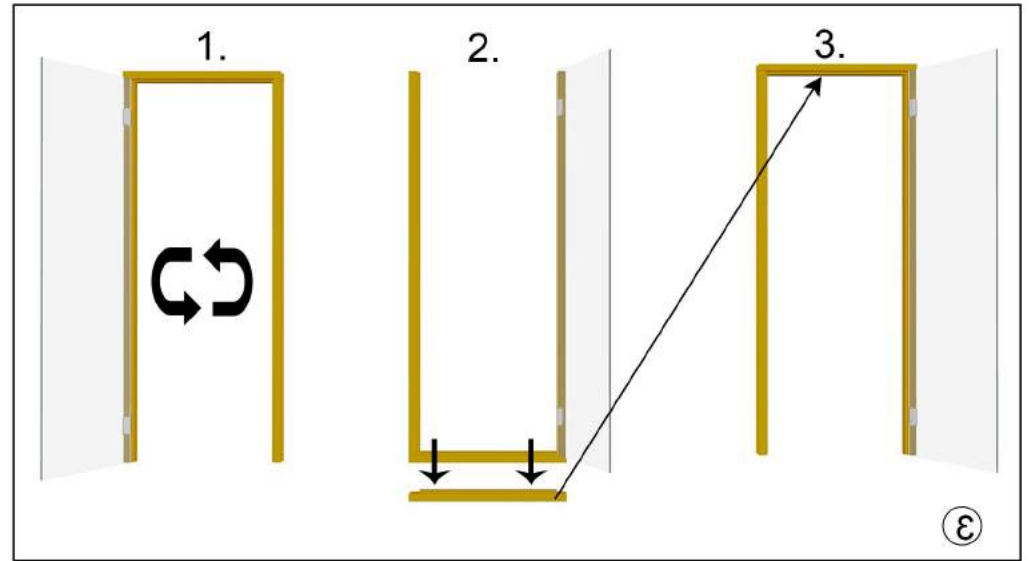
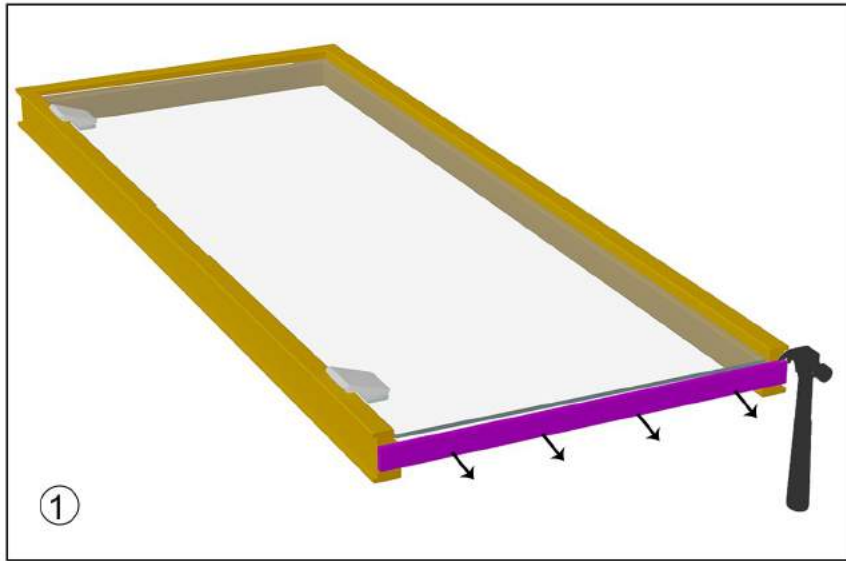

# 9. Fixing D1 & Door & D3

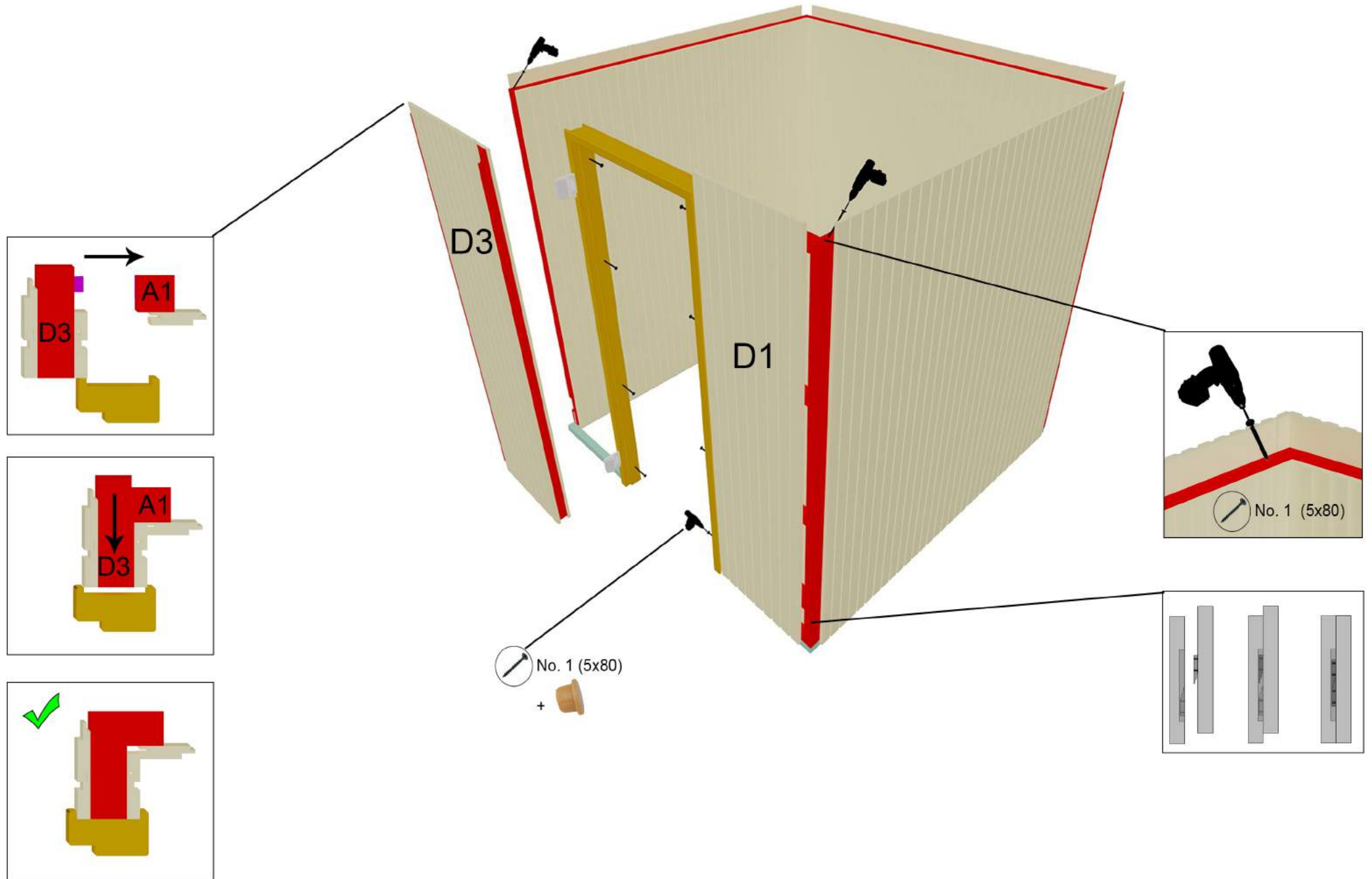

# 10. Fixing D2 & all corners

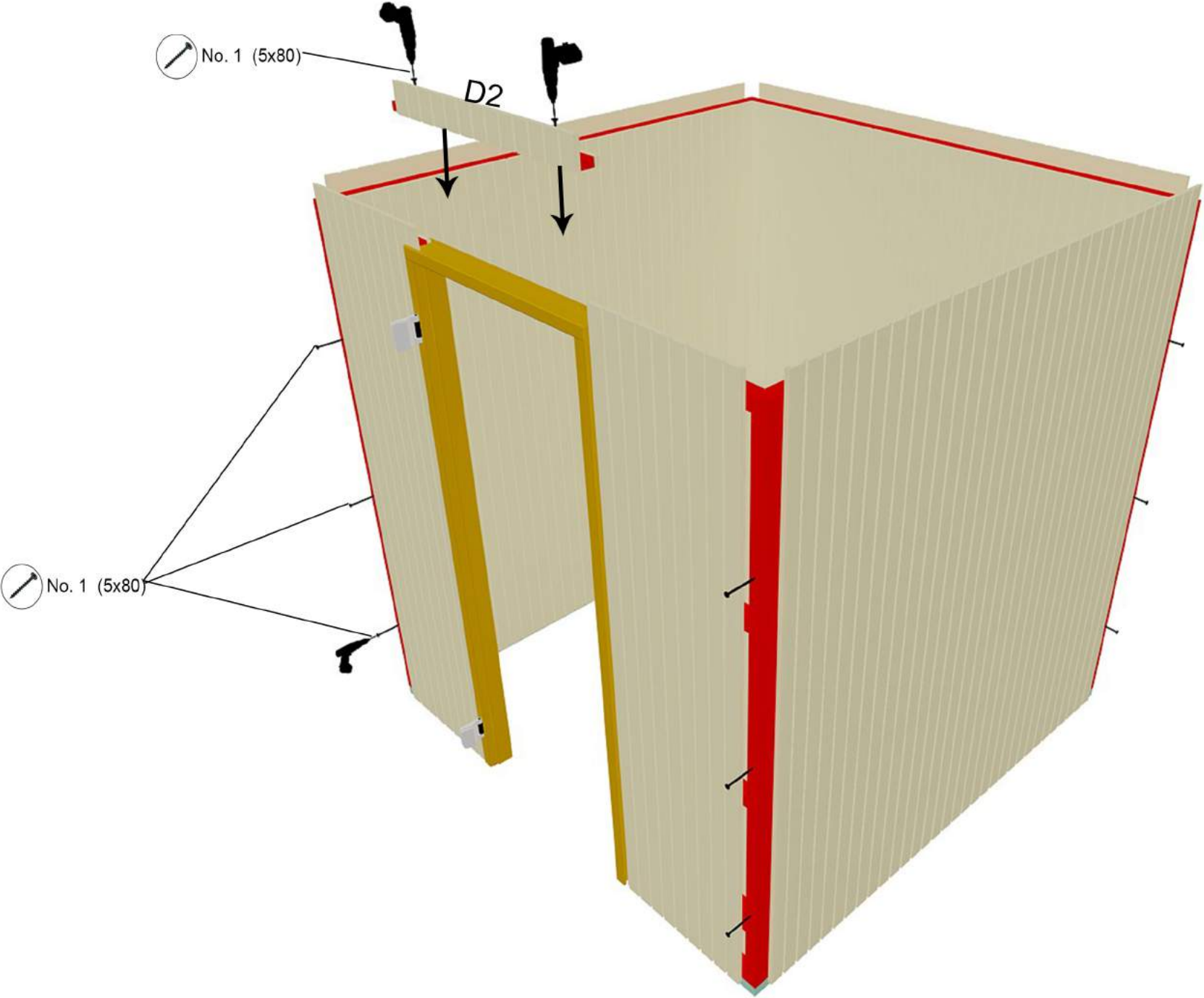

# 11. Fixing ceilings

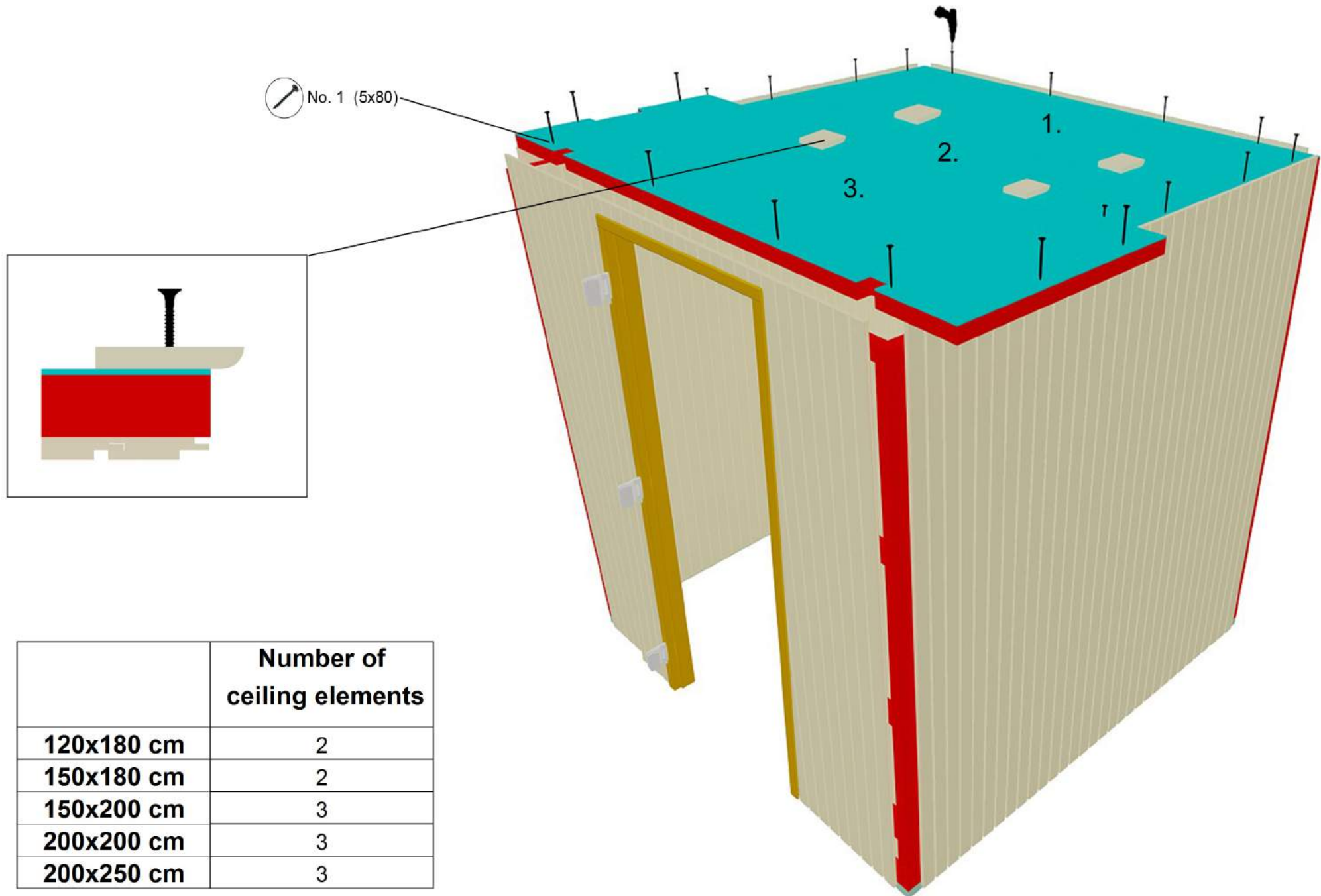

## 12. Interior 120x180 cm

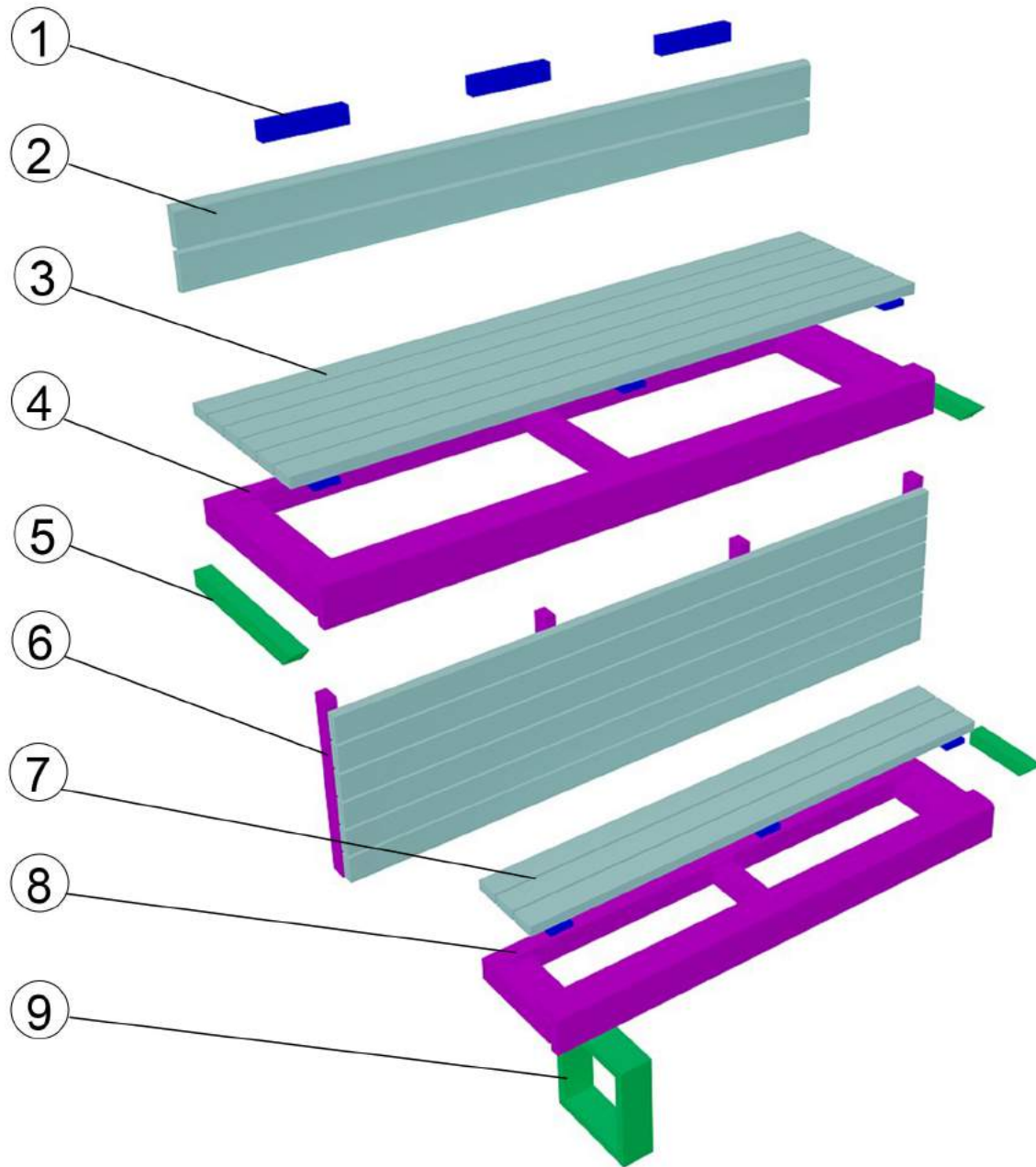

1. Blocks for fixing backrest (3 pcs)
2. Backrest
3. Upper bench grid
4. Upper bench frame
5. Horizontal bench supports(3 pcs)
6. Bench skirt
7. Lower bench grid
8. Lower bench frame
9. Vertical support

## 12.1 Interior 150x180 cm

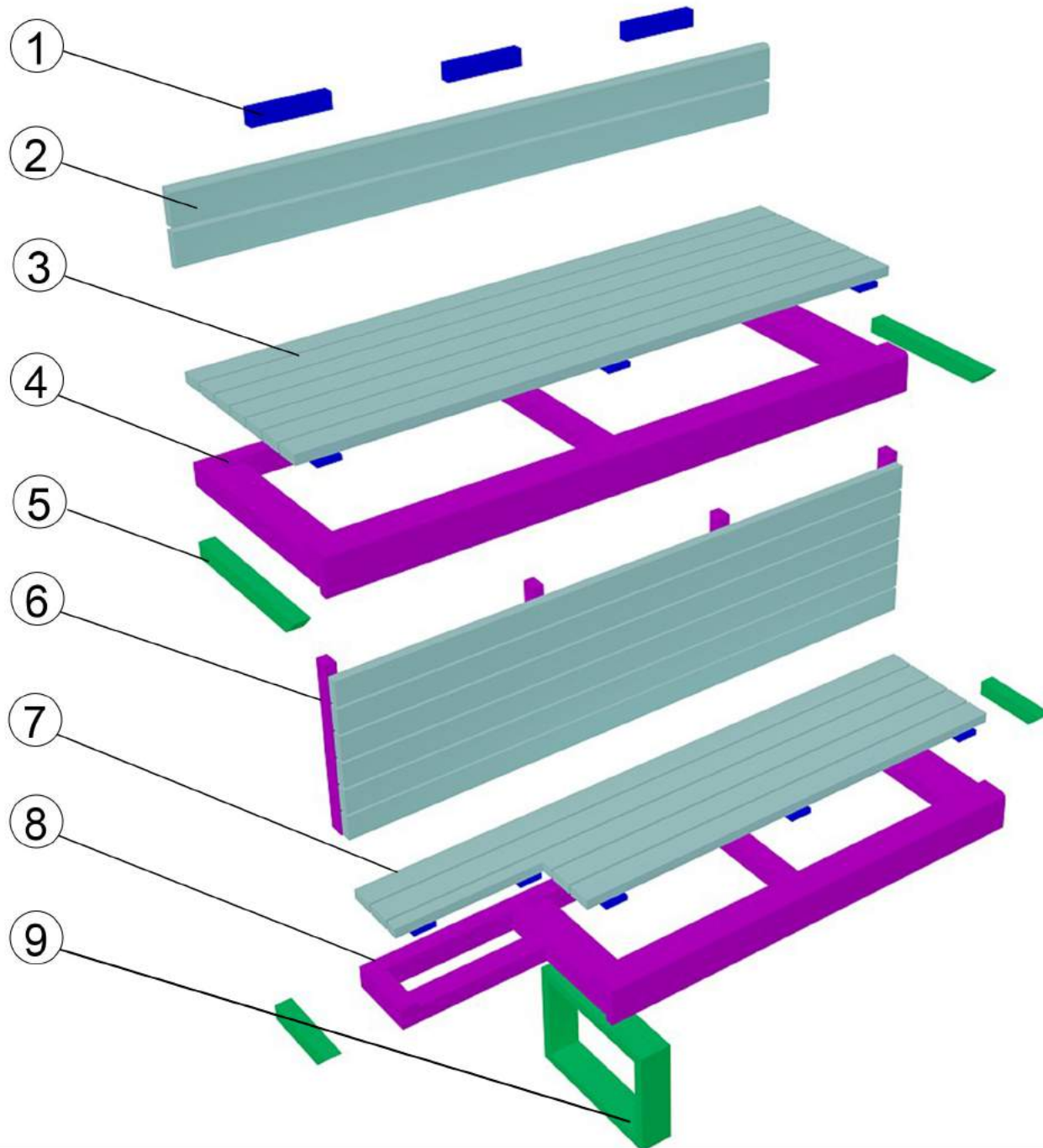

1. Blocks for fixing backrest (3 pcs)
2. Backrest
3. Upper bench grid
4. Upper bench frame
5. Horizontal bench supports(4 pcs)
6. Bench skirt
7. Lower bench grid
8. Lower bench frame
9. Vertical support



## 12.2 Interior 150x200 cm

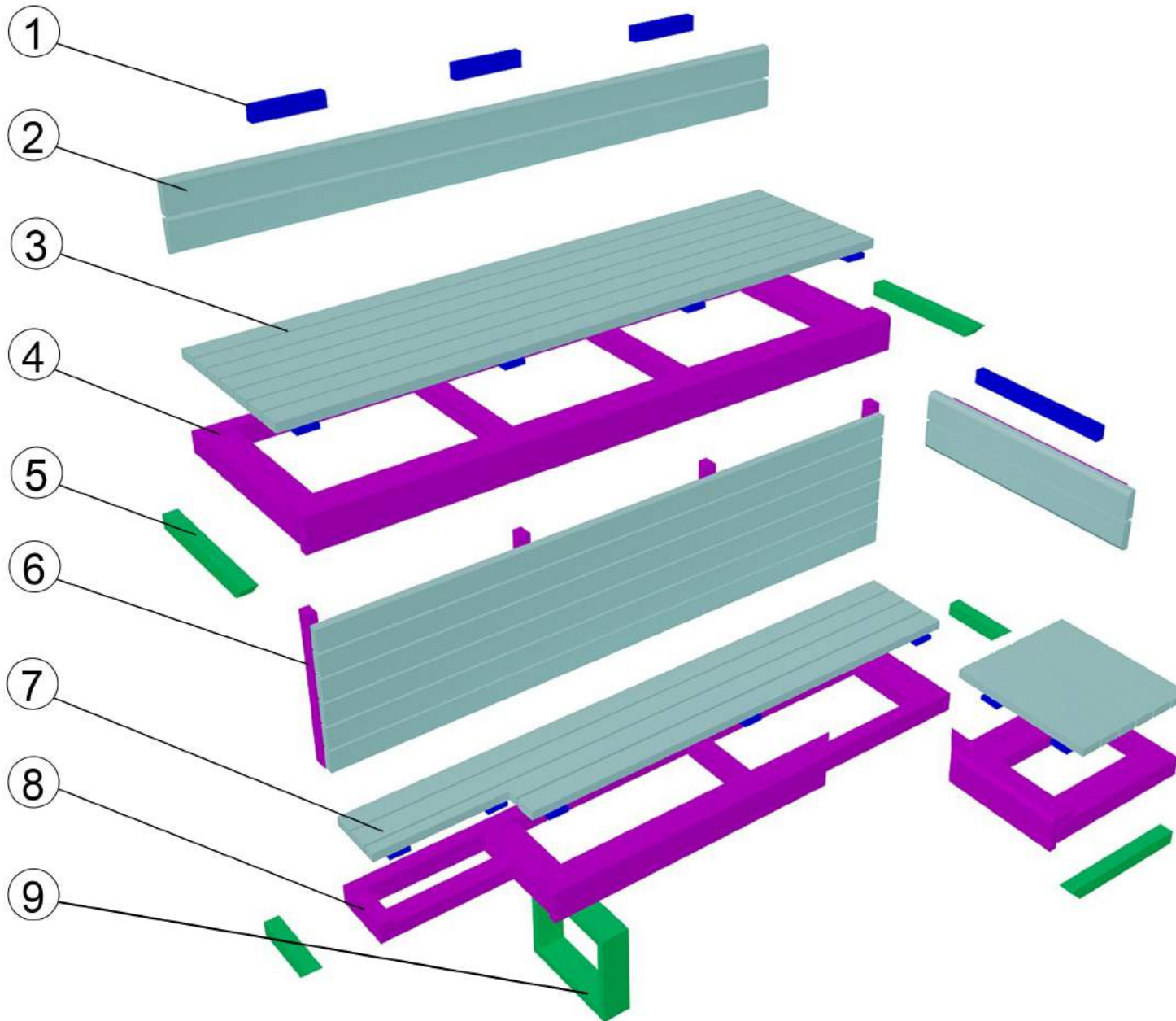

1. Blocks for fixing backrest (4 pcs)
2. Backrest (2 pcs)
3. Upper bench grid
4. Upper bench frame
5. Horizontal bench supports(5 pcs)
6. Bench skirt
7. Lower bench grid (2 pcs)
8. Lower bench frame (2 pcs)
9. Vertical support

## 12.3 Interior 200x200 cm

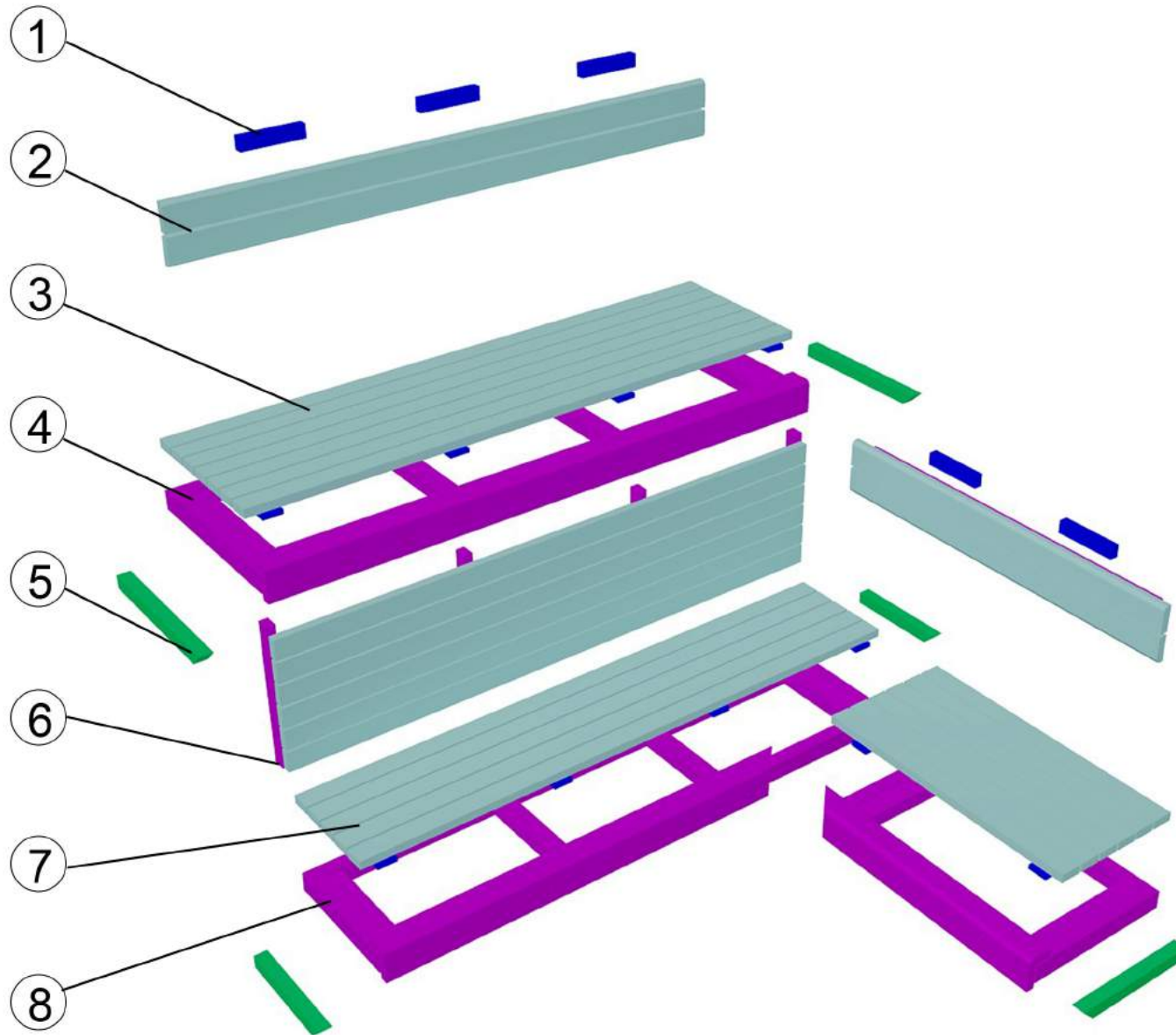

1. Blocks for fixing backrest (5 pcs)
2. Backrest (2 pcs)
3. Upper bench grid
4. Upper bench frame
5. Horizontal bench supports(5 pcs)
6. Bench skirt
7. Lower bench grid (2 pcs)
8. Lower bench frame (2 pcs)

## 12.4 Interior 200x250 cm

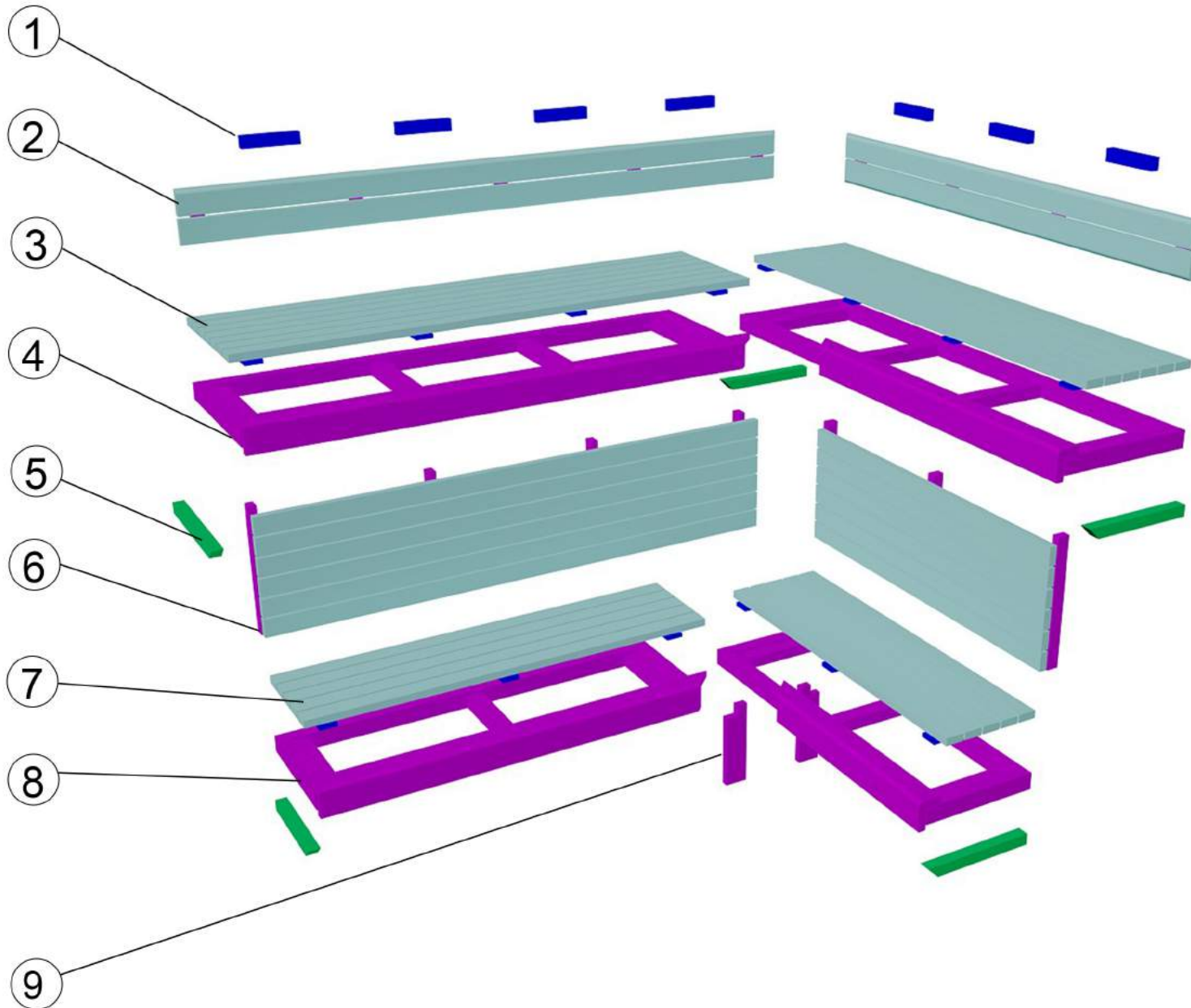

1. Blocks for fixing backrest (7 pcs)
2. Backrest (2 pcs)
3. Upper bench grid (2 pcs)
4. Upper bench frame (2 pcs)
5. Horizontal bench supports(5 pcs)
6. Bench skirt (2 pcs)
7. Lower bench grid (2 pcs)
8. Lower bench frame (2 pcs)
9. Vertical support (2 pcs)

# 13. Supports fixing (200x200 cm as example)

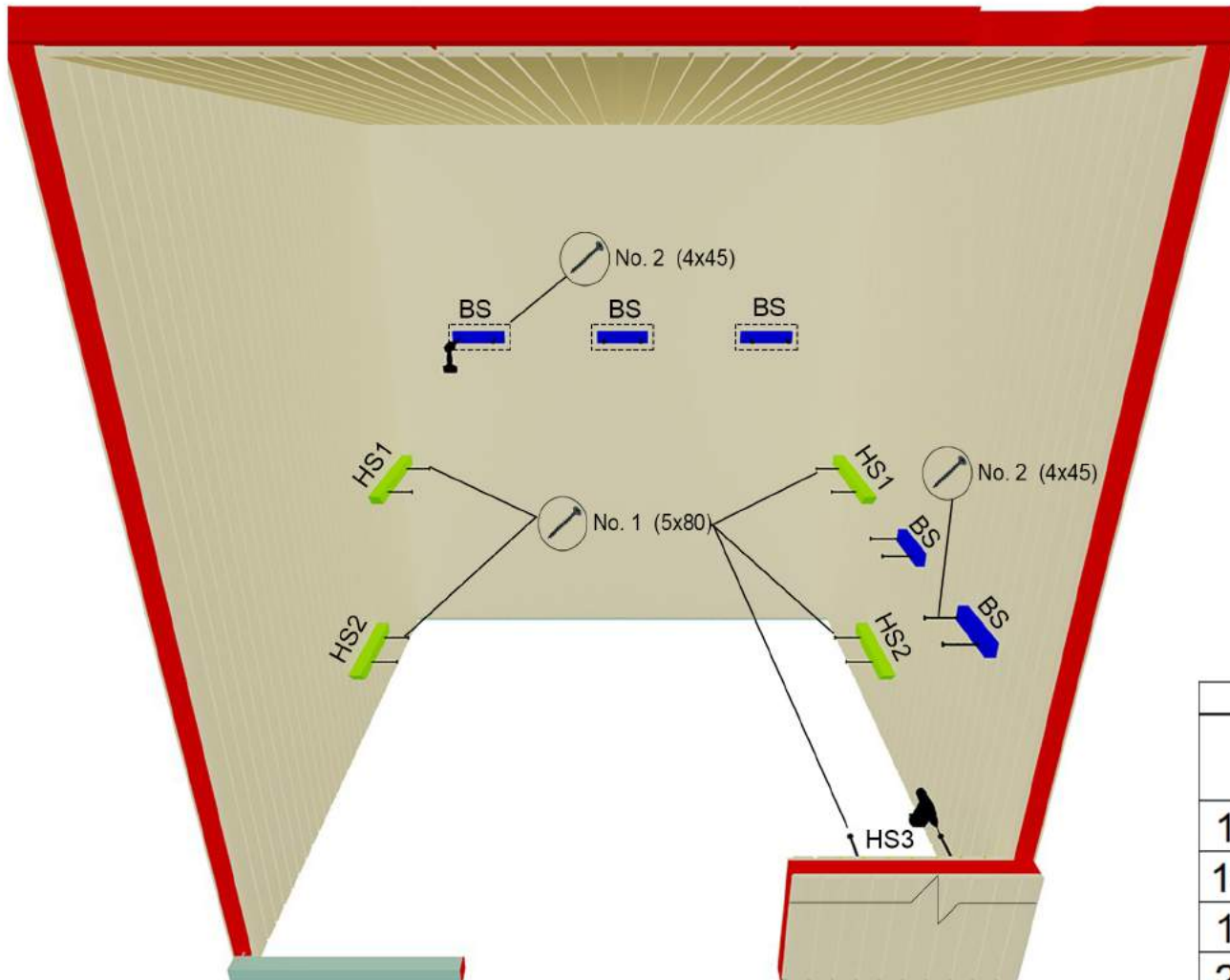

\*All supports have marked boxes where they fit

	Backrest supports(BS)	Horizontal supports(HS)
120x180 cm	3	3
150X180 cm	3	4
150x200 cm	4	5
200x200 cm	5	5
200x250 cm	7	5

# 14. Fixing bench frames & backrests

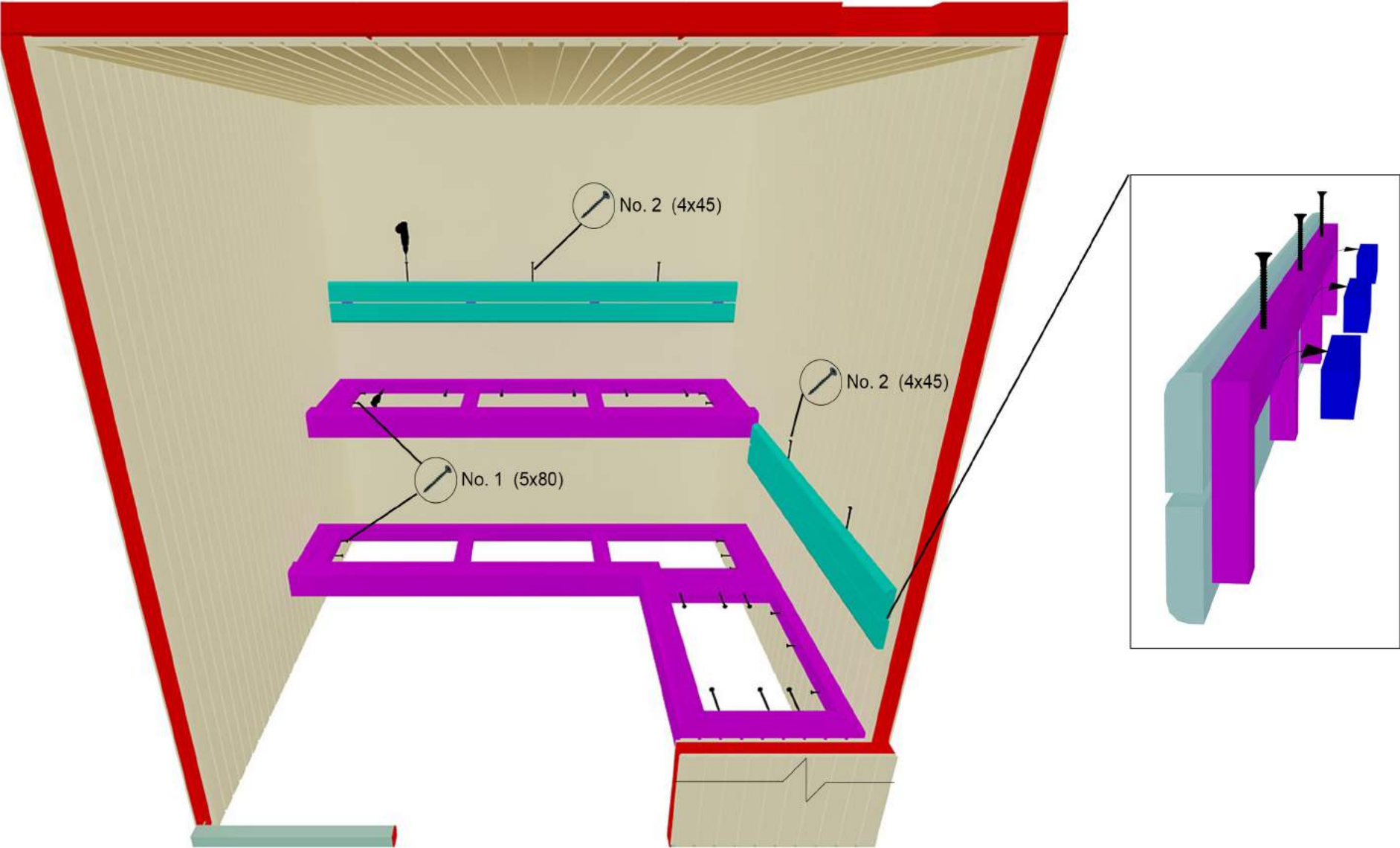

# 15. Fixing vertical support

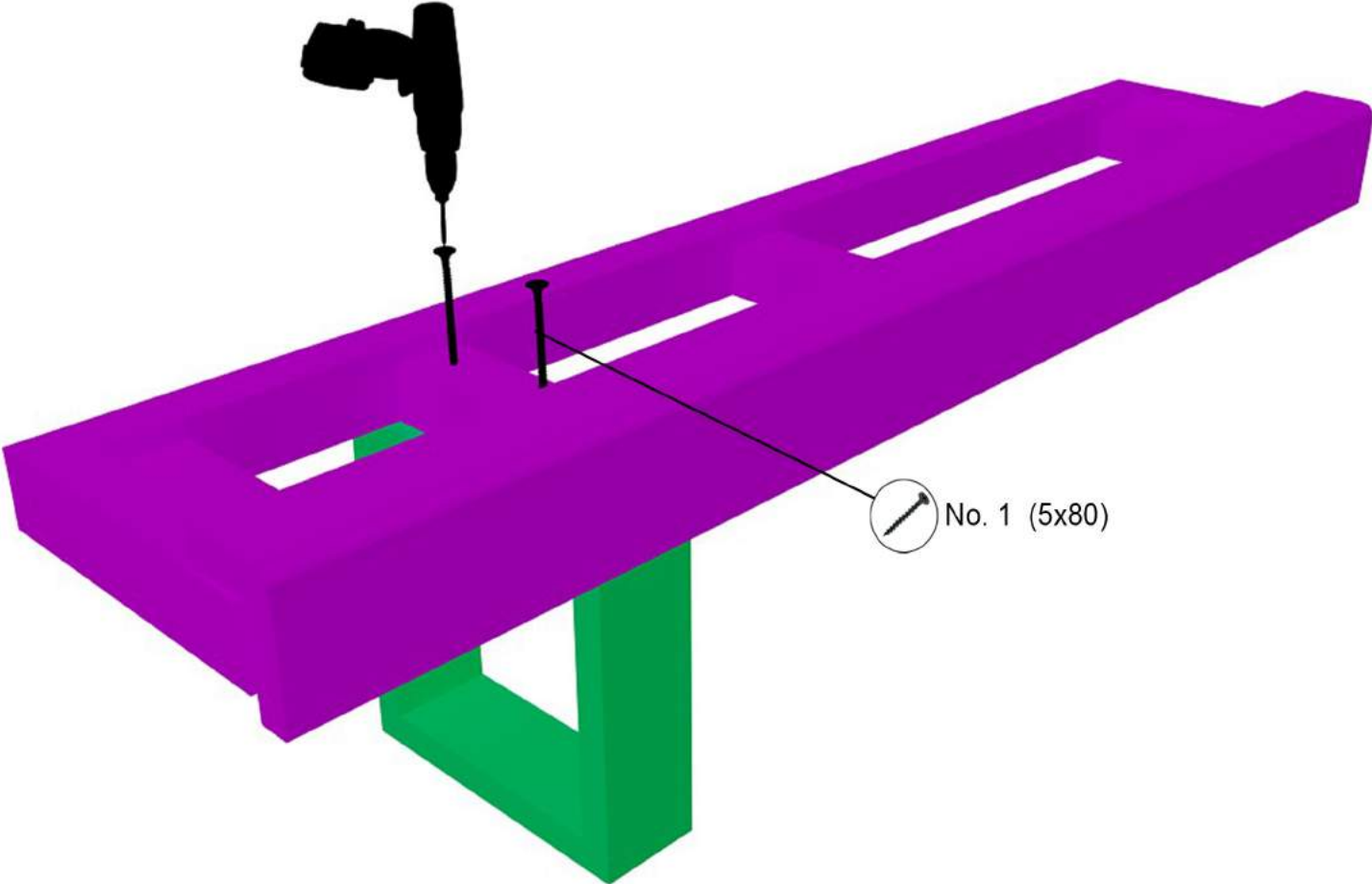

# 16. Fixing bench skirt

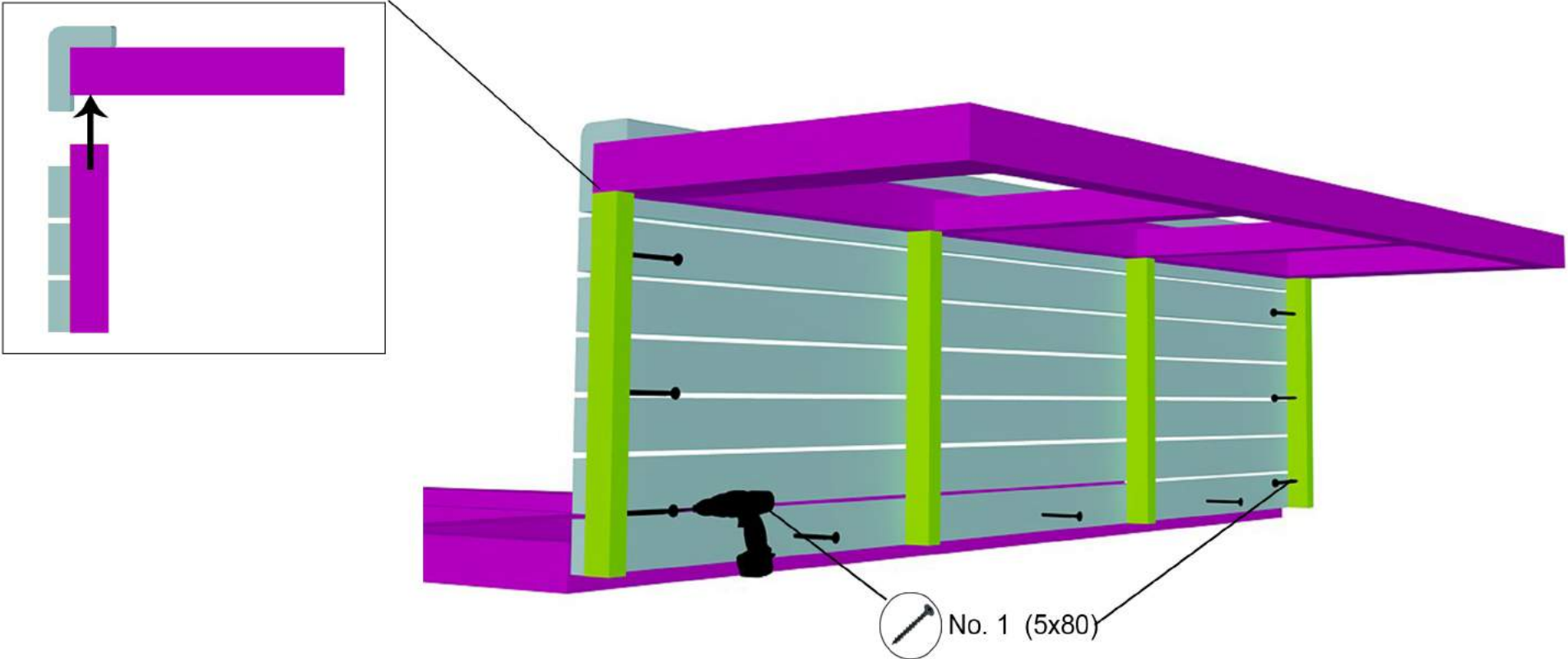

# 17. Bench grids & floor grids

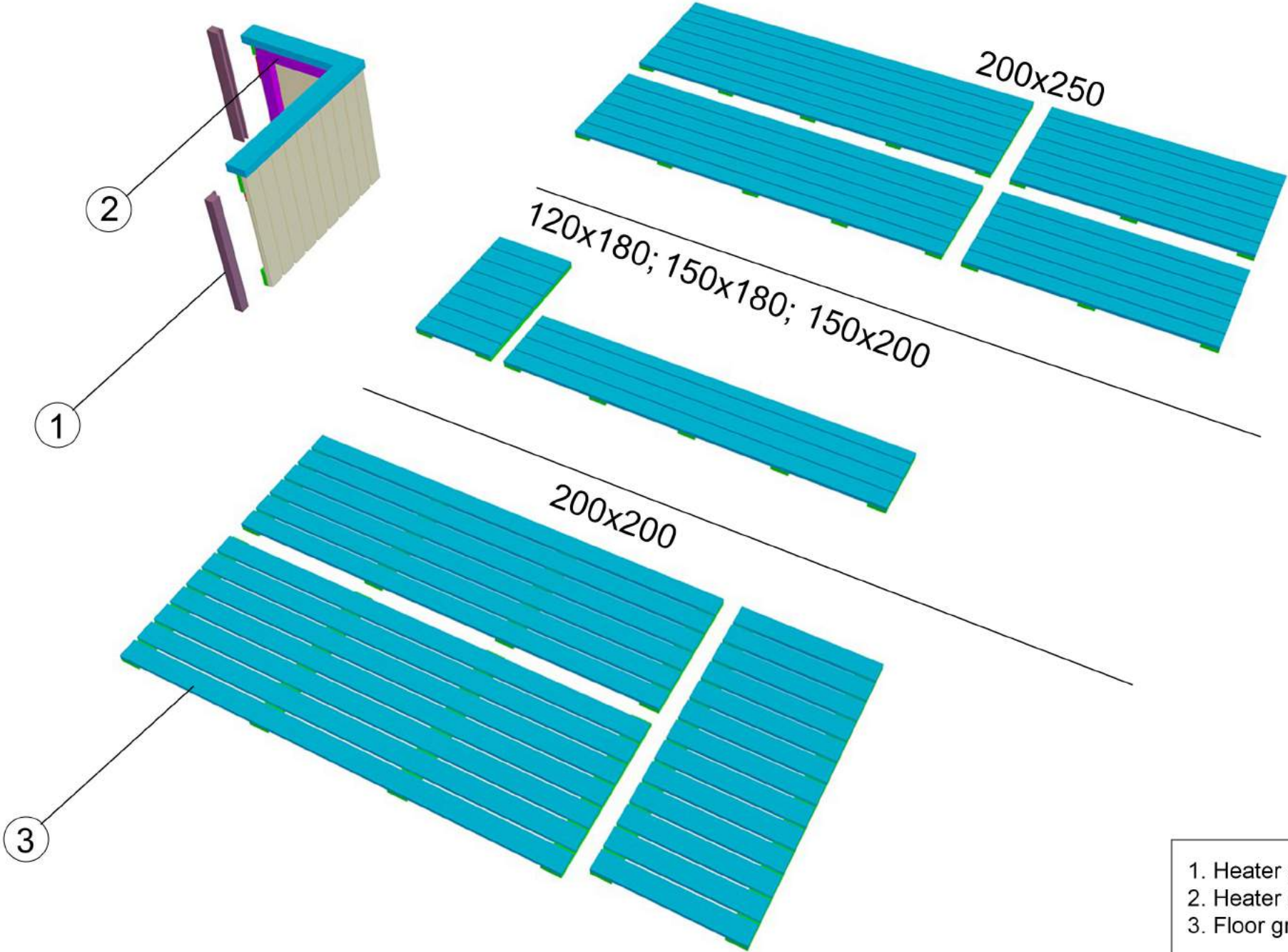

- 1. Heater guard holders
- 2. Heater guard
- 3. Floor grids by model



# 18. Bench grids & floor grids

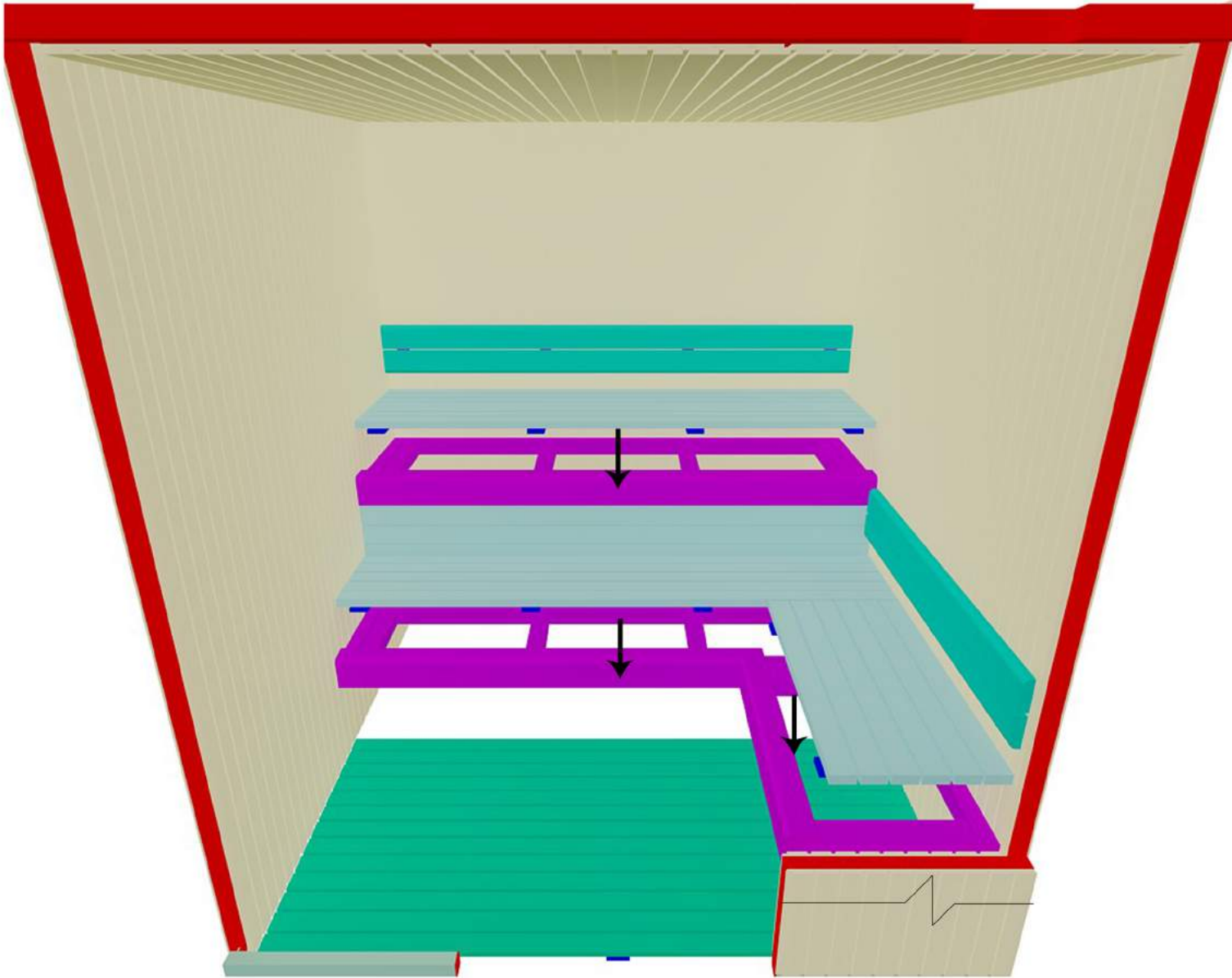

# 19. Fixing heater guard

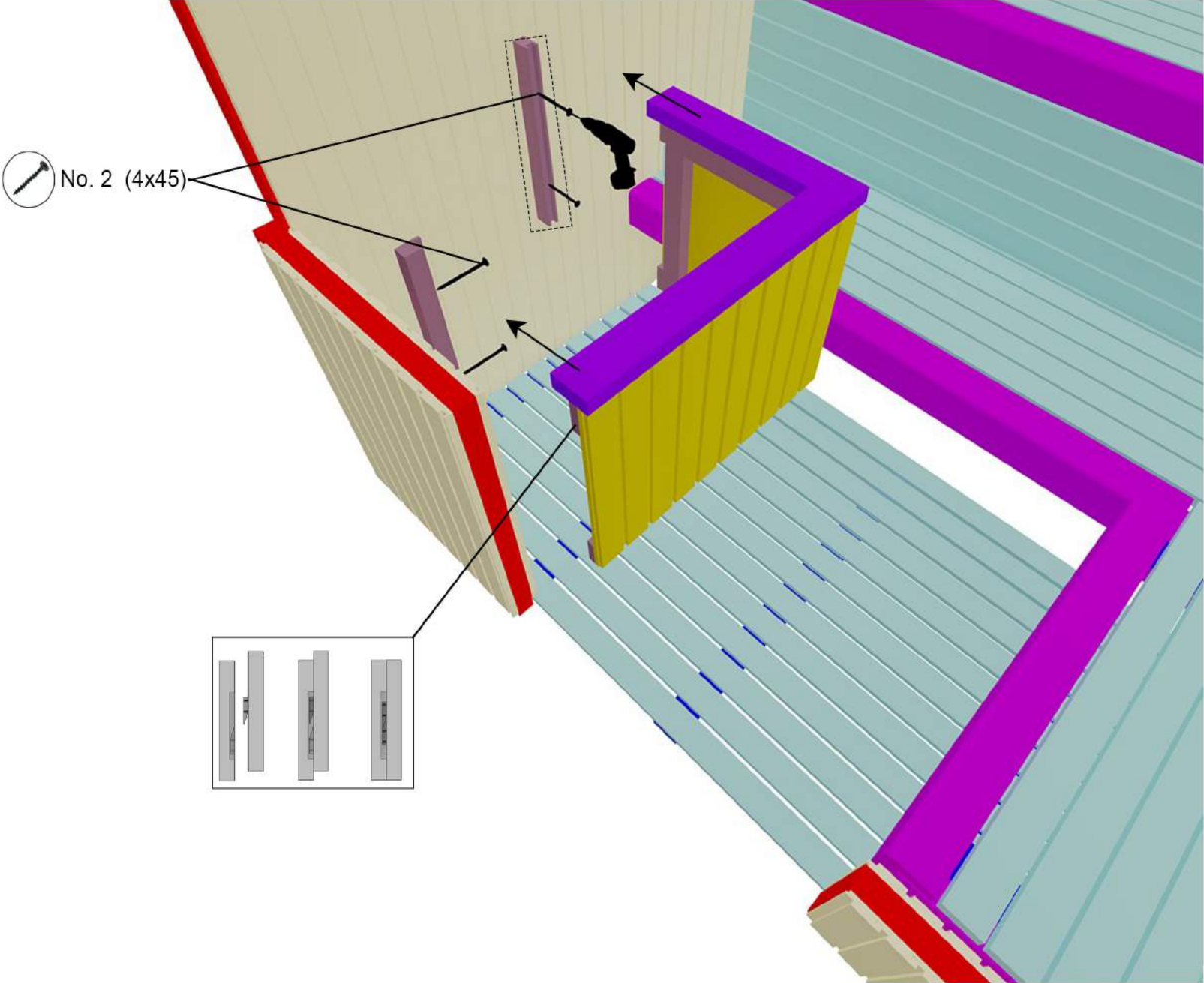

# 20. Fixing horizontal mouldings

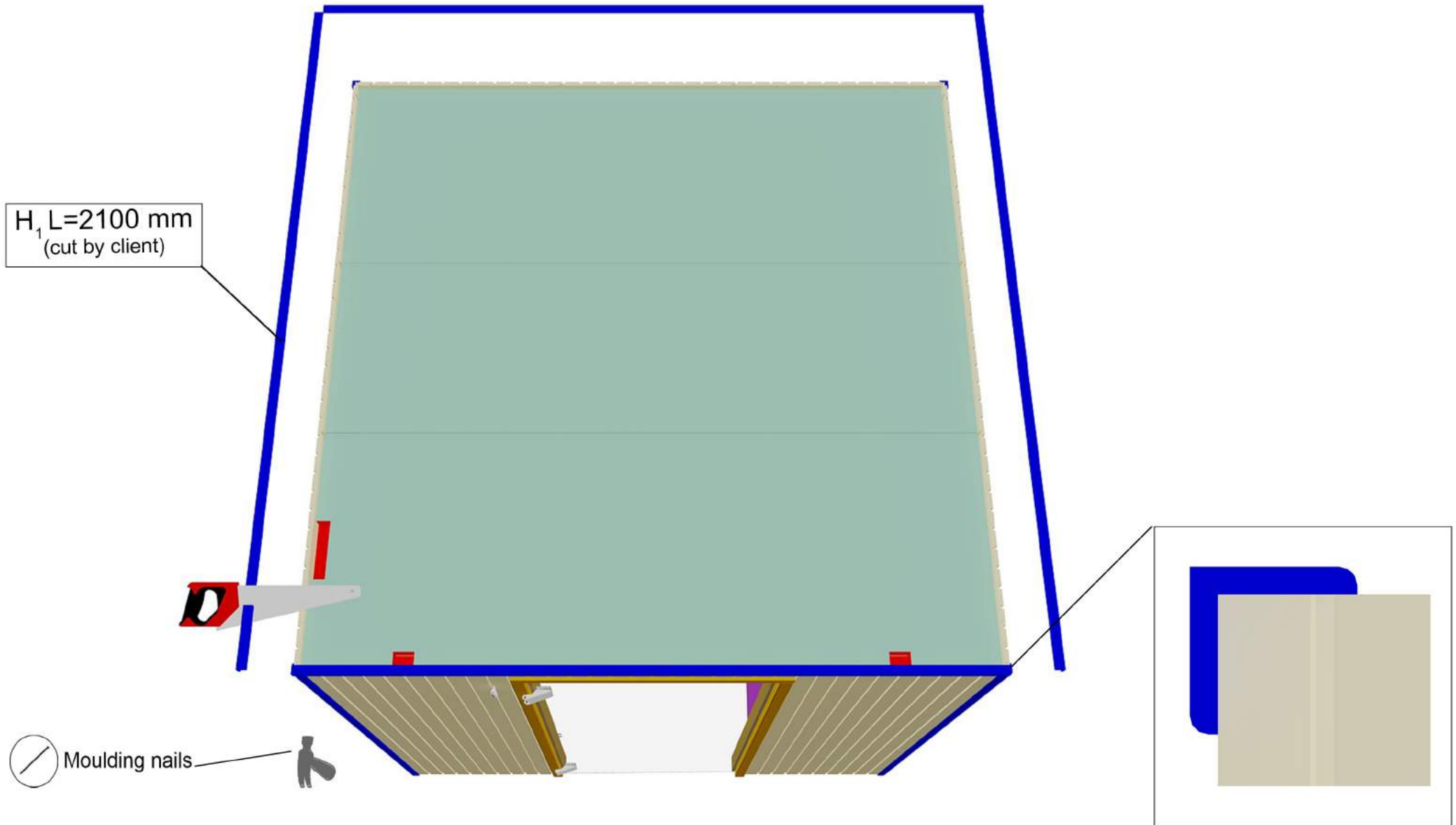

# 21. Fixing vertical mouldings

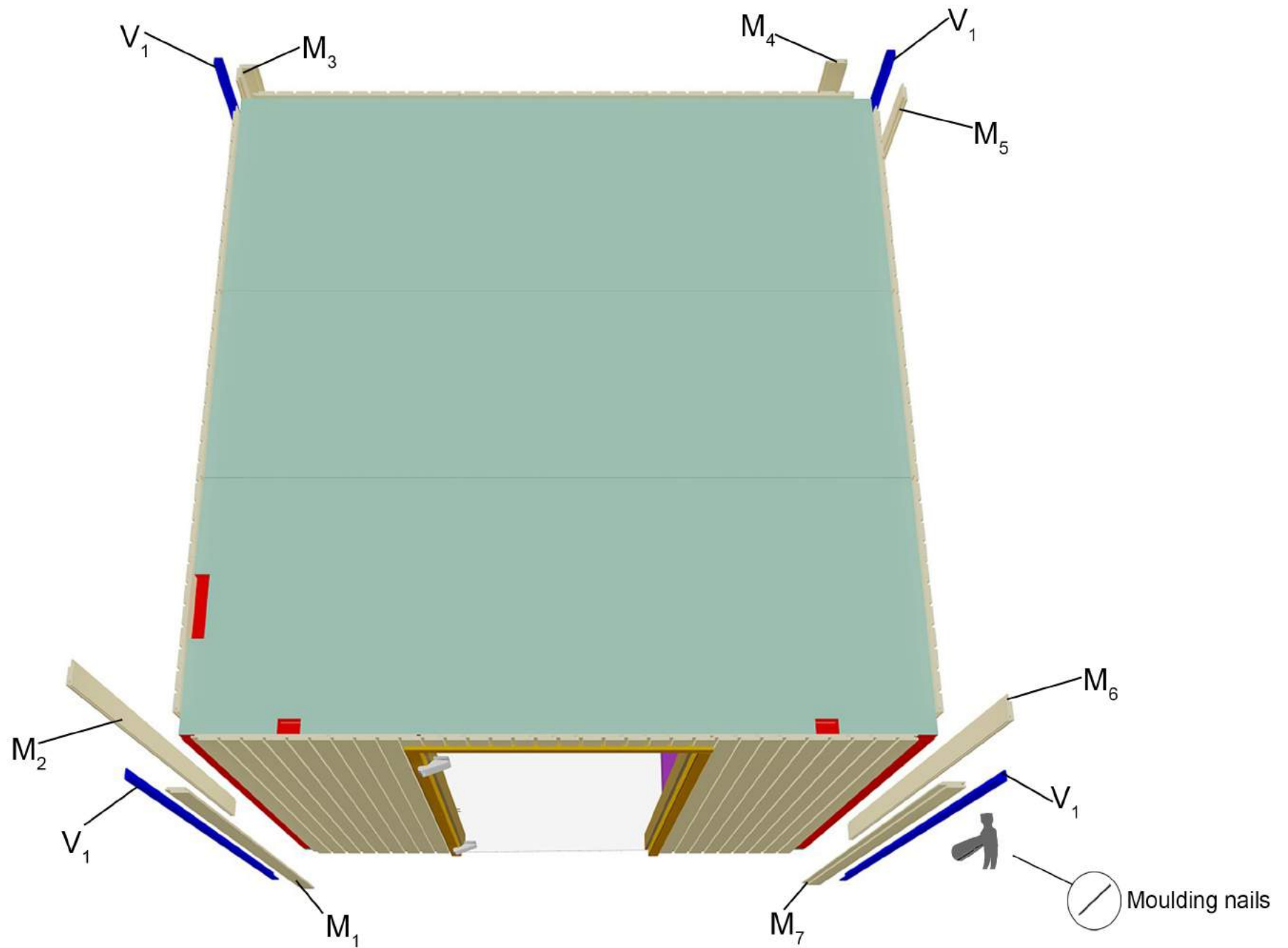

## 22. Fixing wall lights

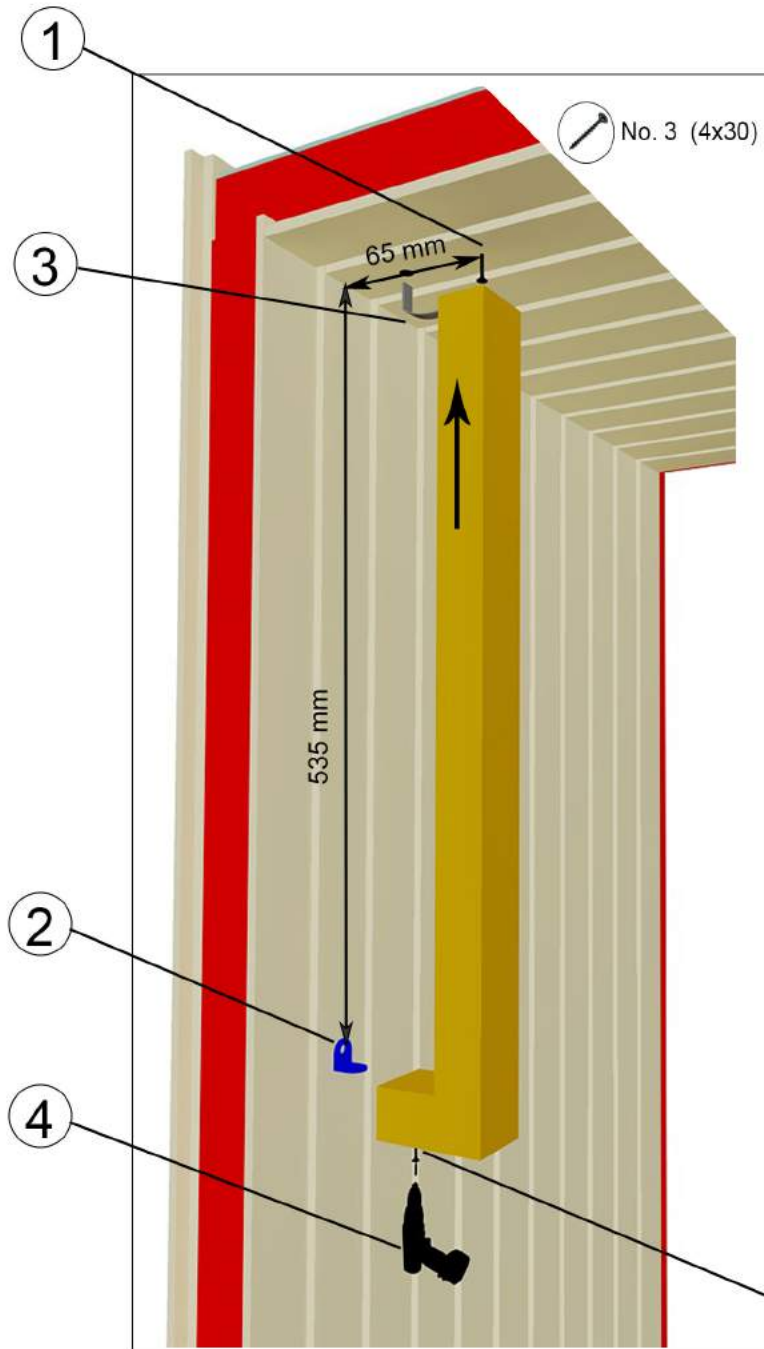

Cable holes in ceiling shows the right position for wall lights

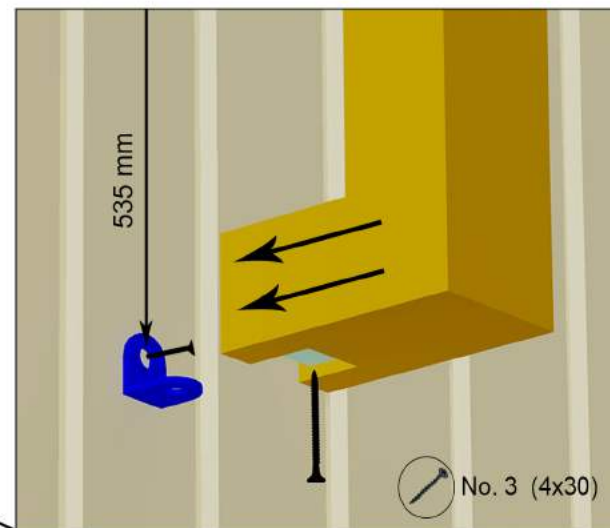

## 23. Wiring inside walls



1. Push down wires from precut holes on ceiling

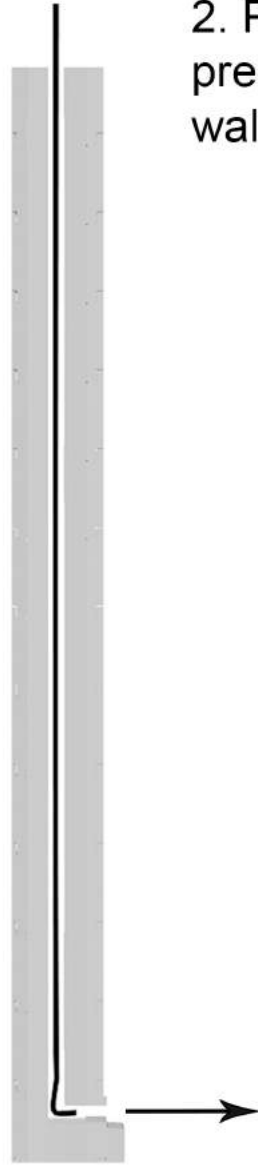

2. Pull out wires from precut holes in the walls

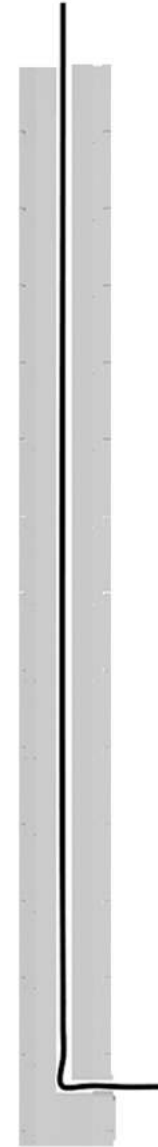

3. Connect wires

## 24. Wiring on ceilings

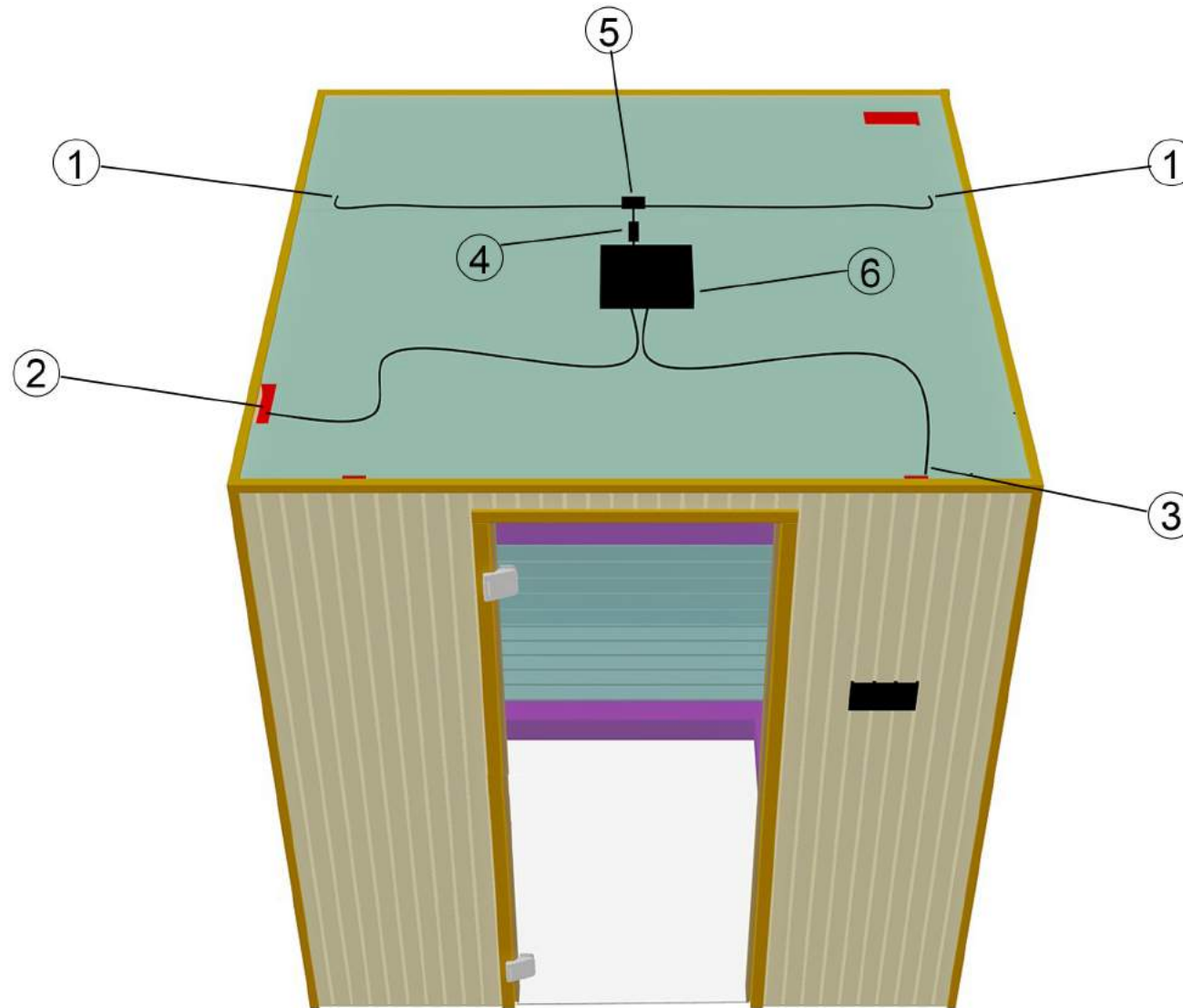

Always use certified electrician !

1. Wall lights cables
2. Heater cable
3. Control unit cable
4. Transformer
5. LED-strip junction boxes
6. Power unit

## 25. Fixing handle

