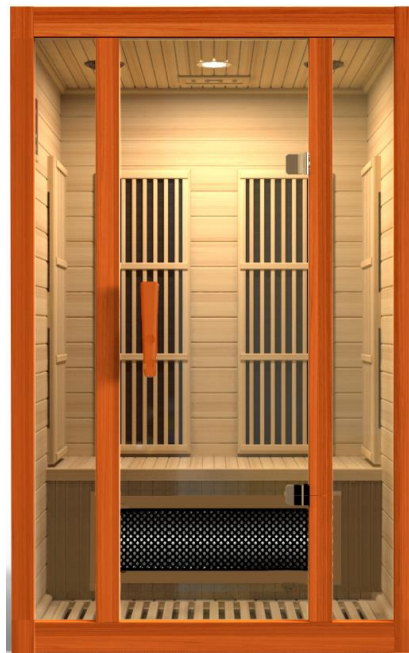


## **Model: MX-J206-02S & MX-J306-02S**



FOR CARBON MODEL SAUNAS

HEMLOCK AND RED CEDAR MODELS

FOR INDOOR USE ONLY

MX-J206-02S: 120V/15AMP DEDICATED CIRCUIT REQUIRED

MX-J306-02S: 120V/20AMP DEDICATED CIRCUIT REQUIRED

# Thank you for your purchase of the Infrared Sauna!

## Index

=====

	Page
Important Safety Guides.....	2
Introduction.....	3
Health & Beauty Benefits.....	3
Highlights.....	4
Assembly.....	4
Operating Your Sauna.....	12
Tips For Using Your Sauna.....	14
Safety Instructions.....	15
Safeguards For Your Sauna.....	16
Troubleshooting Guide.....	16
Warranty.....	19
Warranty Card.....	20

**WARNING:** Visually inspect all heaters before assembly to make sure they are not damaged. Any excessive vibrations during transport could cause damage to the heating elements. **DO NOT START** the sauna if damage is detected! Contact your dealer or manufacturer for troubleshooting and replacement parts.

### DISCLAIMER

The infrared rays emitted by your sauna are reported to offer a wide range of possible therapeutic benefits based on research completed over the last 25 years from all around the world. These benefits are presented for reference purposes only and no implication of infrared saunas creating a cure for or treating any disease is implied nor should it be inferred. If you have a health condition, are taking prescription drugs, or have acute joint injuries, please consult your medical physician before starting infrared therapy. Persons with surgical implants (metal pins and rods, artificial joints, silicone, or other types of surgical implants) typically do not experience any adverse effects, but should also consult their physician or surgeon before starting infrared therapy. Models are subject to change without notice. Pictures shown are for representation only and may not resemble your exact model.

# **READ IMPORTANT SAFETY GUIDES BEFORE USING!**

## **READ AND FOLLOW ALL INSTRUCTIONS**

- A). Please following all warning labels and markings on the sauna room before using.**
- B). Do not install any receptacles on the interior or exterior walls of the sauna room.**
- C). No locking devices are installed or shall be installed on the door of the sauna room which could result in entrapment within the sauna room.**
- D). During use, the ceiling vent can be in the opened position.**
- E). CAUTION! Hyperthermia Danger: the normal body temperature can't rise above 103°F. Symptoms of excessive hyperthermia include dizziness, lethargy, drowsiness, and fainting. The effects of excessive hyperthermia may include failure to perceive heat, physical inability to exit sauna, unawareness of impending hazard, unconsciousness and fetal damage in pregnant women. Hyperthermia could make your body's core temperature rise. You should not set the temperature to an excessively high temperatures.**
- F). Do not use drugs, medications, or consume alcohol prior to or during the sauna session as they may lead to unconsciousness and/or other harmful physical injuries. If absolutely necessary, persons using medications should consult a physician before using the sauna. Some medications may induce drowsiness while others may affect the heart rate, blood pressure, and/or blood circulation.**
- G). WARNING! Your hands must be dry and free of moisture before plugging and unplugging cords and wiring harnesses from the power supply and circuit boards. Never operate the sauna with wet hands or wet feet to avoid risk of electric shock. Never touch the metal prongs of the plug.**
- H). Persons suffering from obesity or with a medical history of heart disease, low or high blood pressure, circulatory system problems, or diabetes should consult a physician prior to using the sauna.**
- I). Do not pour water or any other liquids on the infrared emitters. Do not place combustible materials near on or on the heaters. Do not bump, hit, or break the heating elements as it may cause an electrical short and pose a safety risk.**
- J). To reduce the risk of injury, do not allow children to use the sauna unless they are closely supervised by an adult and use of the sauna has been prescribed by a medical physician.**
- K). If the power supply cord becomes damaged, it must be replaced immediately by the manufacturer or its agent. If you find the power cord is too hot or that the electrical equipment may be experiencing technical problems, please contact the manufacturer or its agent immediately to avoid hazardous conditions.**
- L). Pregnant or possibly pregnant women should contact their physician prior to using the sauna. Excessive temperature has the potential for causing fetal damage during pregnancy.**

- M). Never sleep inside the sauna.
- N). Do not use any type of cleaning agents on the interior of the sauna. Only wipe down with a cloth and water.
- O). Do not stack or store any object on top or inside the sauna.
- P). Do not use the sauna during an electrical storm to avoid risk of shock.
- Q). Do not attempt to make any repairs yourself. If a problem occurs with the sauna, please contact seller, distributor, or the manufacturer to avoid safety risks. Unauthorized repair attempts will void the manufacturer's warranty.
- R). Please make sure the outlet power supply meets the specifications required. Failure to meet the requirements may cause safety risks.
- S). Some sauna models are equipped with reading and roof lamps. Because the lamp temperature will become very hot once powered on, do not attempt to touch the lamp to avoid being burned. Do not attempt to touch it for at least 20 minutes after it has been powered off.
- T). Do not make any modifications to the sauna, the sauna structure, or the sauna components.

## SAVE THESE INSTRUCTIONS

### Introduction

We welcome you to the most affordable infrared sauna in the nation! We also congratulate you on your new path to better health! Thousands of users enjoy the benefits of infrared saunas every day. Infrared saunas help you burn calories, reduce toxins, relieve pain and even clear complexions. Now you can enjoy the great benefits of far infrared heat within the privacy of your own home.

### Health & Beauty Benefits

**Relieve pain:** The far infrared rays of a sauna accelerate the blood circulation and supply more oxygen to the body. Increased blood circulation diminishes inflammation, relieves pain, and speeds up recovery. Infrared saunas have also been used to treat bursitis, rheumatism, arthritis, and hemorrhoids. Increased blood circulation not only alleviates internal ailments, but also skin conditions such as psoriasis, eczema and scars. Good circulation is essential for smooth and healthy skin.

**Burn calories & fat:** The far infrared rays of the sauna eliminate extra salt and subcutaneous fat. Burn up to 600 calories in a half hour session versus a half hour of jogging which burns 300 calories or a half hour of cycling- which burns 225 calories.

**Relax your body and mind:** Use the built-in CD player to listen to your favorite music to relax and reduce stress. Infrared saunas also improve symptoms of insomnia and other stress related disorders.

**Reduce toxins and improve complexions:** Perspiring in a lower temperature environment activates the sweat glands and expels toxins and heavy metals from the body.

## Highlights

- High quality craftsmanship
- Automatic thermostat for constant temperature
- Timer and buzzer: buzzer sounds 5 minutes before the end of the sauna session
- Digital sensor and thermometer
- Infrared carbon heat emitter panels
- Power supply:

**Main Power:** main power to sauna room

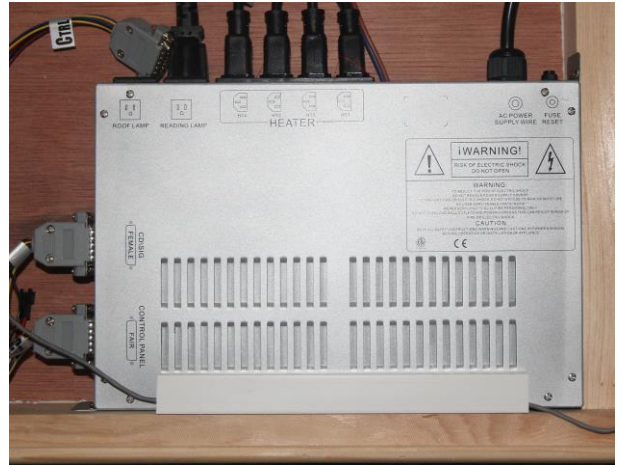
**HT1, HT2, HT3, & HT4:** power to heaters

**Light:** power to reading lamp

**CTRL:** power to control panel

**CD/SIG:** communication to MP3 Jack,  
Speakers, and temperature sensor

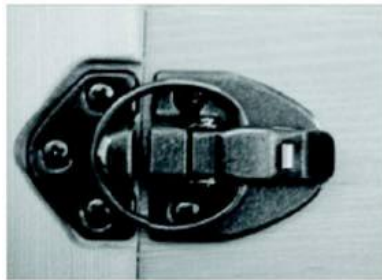
**Fuse Reset:** resets the power supply



- MP3 Jack



- Buckles



## Assembly

**PLEASE NOTE:** The pictures and diagrams shown within this owner's manual are for representation only. Actual model may vary. Please note that your sauna has been completely assembled and tested at the factory prior to packaging. Please further note that the rear wall panel is intentional warped as part of the overall design. Two adults will be needed to assemble the sauna room.

## Assembly Requirements

- You will need a Philips screwdriver, ladder, and two adults to assemble.
- Do not plug any other appliances into the power supply of the sauna room other than the designated sauna connections/plugs.
- Assemble the sauna room on a completely level surface.
- Do not spray or get water on the exterior/interior walls of the sauna room. If the floor is damp, install a floor separator to keep the sauna high & dry.
- Do not store flammable objects or chemical substances near the sauna.

### Sauna Room Assembly:

- Structure of Infrared Sauna. **See FIG-1**
- Make sure all parts are present before installing the unit. See packing list below.

- |                       |                              |                      |                           |                            |
|-----------------------|------------------------------|----------------------|---------------------------|----------------------------|
| <b>A.</b> Front Panel | <b>B.</b> Floor Panel        | <b>C.</b> Back Panel | <b>D.</b> Left Side Panel | <b>E.</b> Right Side Panel |
| <b>F.</b> Bench       | <b>G.</b> Bench Heater Panel | <b>H.</b> Roof Panel | <b>I.</b> Roof Cover      | <b>J.</b> Floor Heater     |
| <b>K.</b> Handle      |                              |                      |                           |                            |



1. Power Supply	6. Left Side Panel	1000 x 300mm	200W
2. Color Lights	7. Rear Wall Panels	1000 x 400mm	300W
3. Temperature Sensor		1000 x 400mm	300W
4. Speakers	8. Rights Side Panel	1000 x 300mm	200W
5. Control Panel	9. Bench Support Panel	18 x 570mm	300W
	10. Floor Panel	1000 x 400mm	300W

**FIG-1a**

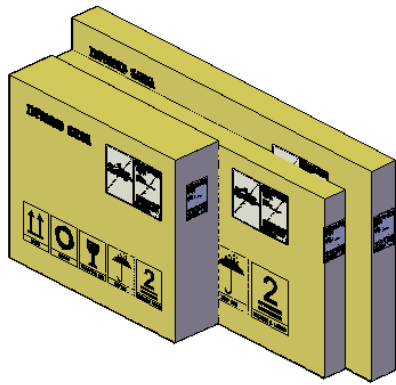
## MX-J306-02S



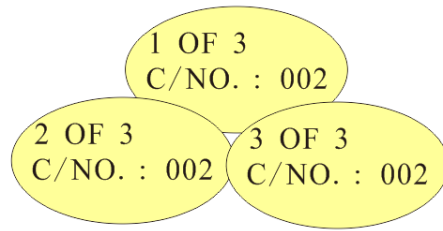
1. Power Supply	6. Left Side Panel	1000 x 400mm	300W
2. Color Lights	7. Rear Wall Panels	1000 x 400mm	300W
3. Temperature Sensor		1000 x 400mm	300W
4. Speakers		1000 x 400mm	200W
5. Control Panel	8. Right Side Panel	1000 x 400mm	300W
	9. Bench Support Panel	18 x 570mm	300W
	10. Floor Panel	1000 x 400mm	300W

**FIG-1b**

4. 2-person saunas are packed into two cartons. For example: C/NO: 002 1 OF 2 and C/NO: 002 2 OF 2.  
 3-person sauna and 4-person saunas are packed in three cartons. For example: C/NO: 002 1 OF 3, C/NO: 002 2 OF 3, and C/NO: 002 3 OF 3. **See FIG-2.1 & 2.2**



**FIG-2.1** Cartons



**FIG-2.2** C/No.

- Place the Floor Panel on a smooth/flat surface and make sure which side is the front and which side is the back. The front of the floor has **no** stain finish as the other three sides do. **See FIG 3.**



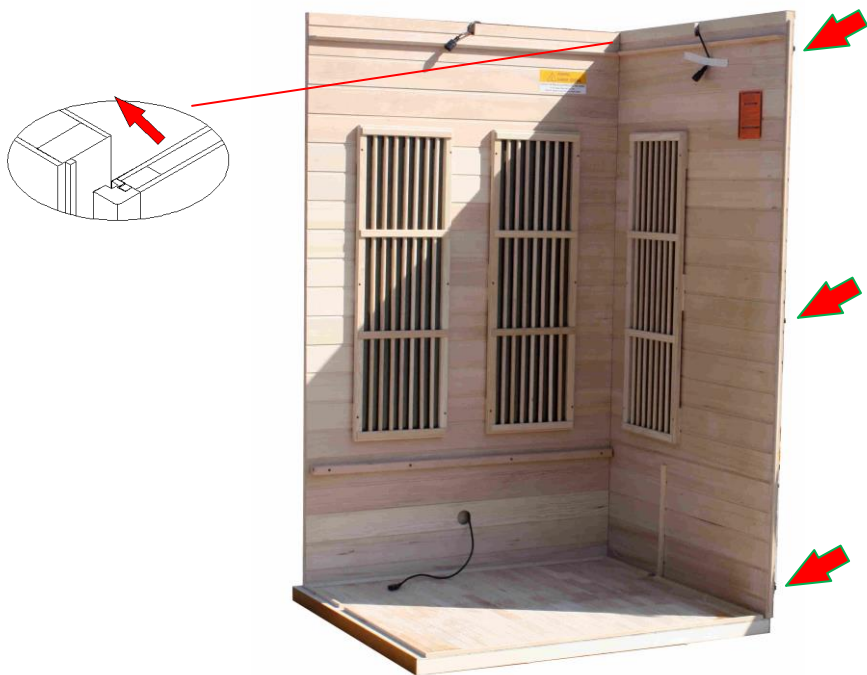
**FIG 3** Placing Floor Panel



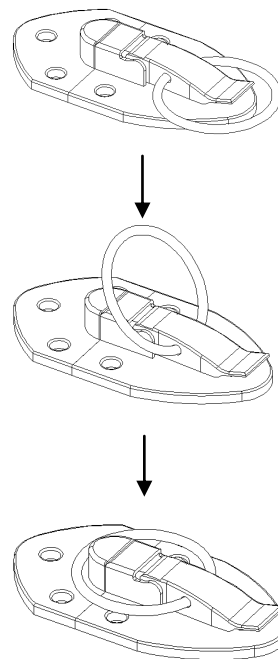
**FIG 4** Assembling Back Panel

- Align the Back Panel by placing it up and onto the Floor Panel. It should sit up against the quarter round trim molding on the Floor Panel. One person should hold the Back Panel while the other person continues to the next step. **See FIG 4**
- Align the Right Side Panel by placing it up and onto the Floor Panel; make sure the Right Side Panel fits flush into the Back Panel. **See FIG 5**





**FIG 5** Assembling Right Side Panel

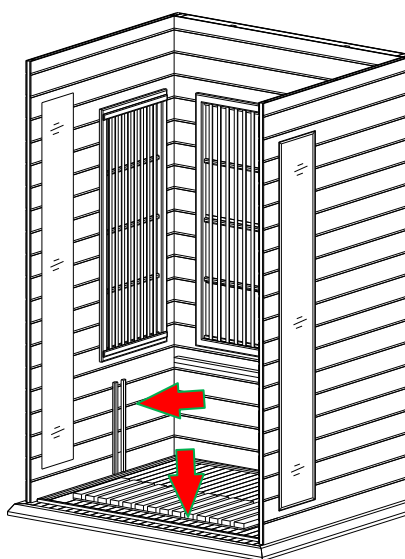


**FIG 6** Buckle

7. Latch the Right Side Panel with the Back Panel. The buckle has a guide tab that must be placed in the guide slot for alignment. When the Back Panel and the Side Panel are attached together on the floor panel, make sure all the buckles are latched. **See Figure 6**
  
8. Align the Left Side Panel by placing it up and onto the Floor Panel; make sure the Right Panel fits flush into the Back Panel and latch together. **See FIG 6 and FIG 7**

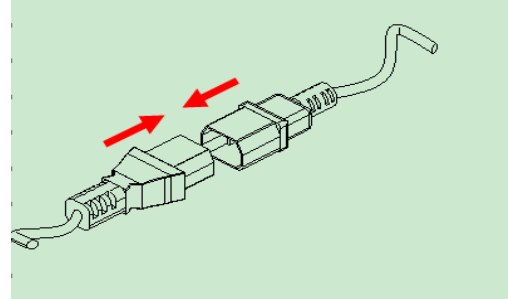
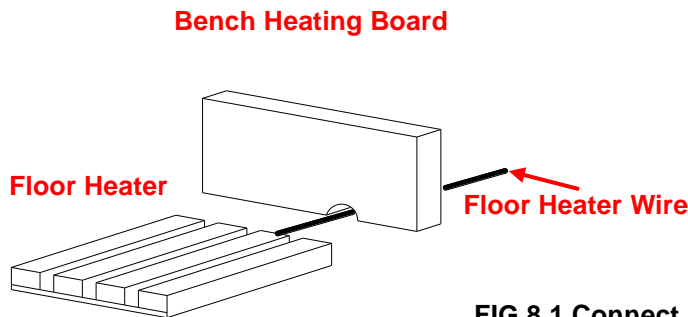


**FIG 7** Assembling Right Panel



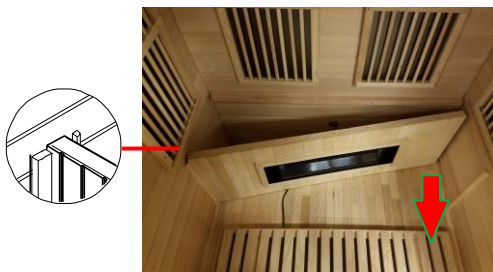
**FIG 8** Placing Floor Heater

9. Place the Floor Heater on the Floor Panel making sure that the Floor Heater is in front of the Bench Heater Panel slots. Please note there is a pre-cut small hole under the Bench Heater Panel which is provided for the Floor Heater cord. Connect the Floor Heater cord to the cord coming from the Left Side Panel. **See FIG 8 & 8.1**

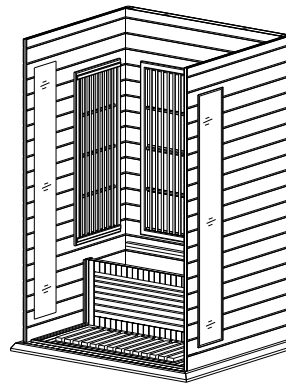


**FIG 8.1 Connect Floor Heater**

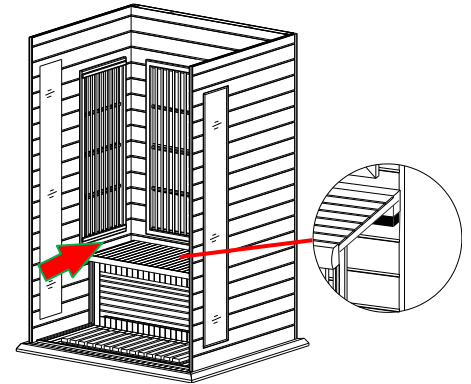
10. Slide the Bench Heater Panel down (vertically) into the slot at an angle and pull it forward as seen in FIG 9. Connect the Bench Heater Panel cord with the cord coming from the Rear Wall Panel. Next, place the Bench on top of the Bench Heater Panel and slide it into place all the way back against the Rear Wall Panel. **See FIG 9, 9a & 10** Note: Make sure the cords are connected snug and tight, otherwise the heaters will not work.



**FIG 9 Installing Bench**



**FIG 9 Connecting Cord**

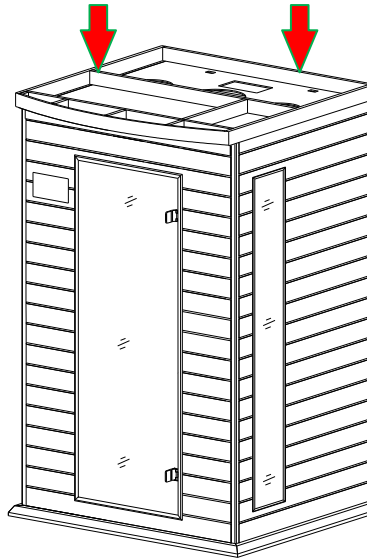


**FIG-10 Installing Bench**

11. Align the Front Panel up against the Floor Panel. Remember, this side of the Floor Panel has **no** stain finish. Next, latch the Front Panel with the Left and Right Side Panels respectively. **Note: Be cautious with the glass door to avoid breakage. See FIG 11.**

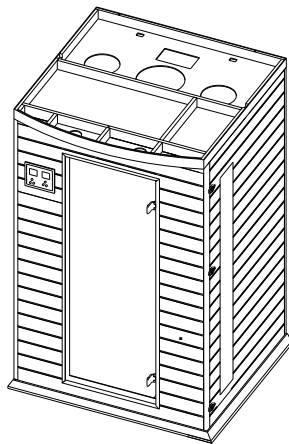


**FIG 11** Assembling Front Panel



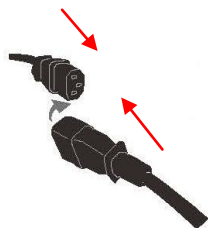
**FIG 12** Installing Roof Cover

12. Place cords/wires of Side Panel and Back Panel into the sauna room area to avoid damaging the cords/wires during the roof installation. Open the door, lift the Roof Panel up and over the sauna room, and gently lower it into place resting it on the wall panels. **See FIG 12.** Make sure that all cords/wires are slipped through the corresponding holes in the Roof Panel. Proceed in screwing the Roof Panel down. **See FIG 13**



**FIG-13** Slip cords/wires through corresponding holes

13. Connect all the wires and connectors to the corresponding outlets on the Roof Panel. Please be sure all the plugs are connected snug and tight. **See FIG 14.**



**FIG-14** Connecting cords/wires connectors

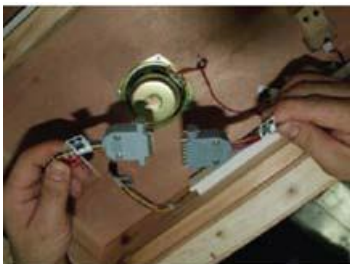
Connect the plugs according to the respective labels. Connect the CTRL plug from the power supply to the CTRL plug from the control panel. Then screw the two connections together. Last, connect the buzzer connection. **See FIG 14 – FIG 18.**



**FIG 15**



**FIG 16**

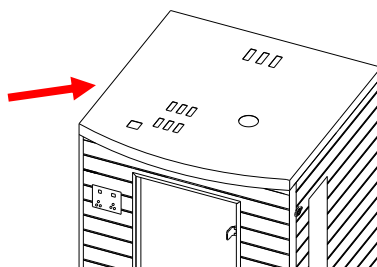


**FIG 17**



**FIG 18**

14. Make sure all steps are completed correctly. Plug in the power cord to your wall outlet. Turn on the sauna at the control panel to confirm that the control panel is responding. If the control panel responds accordingly, then proceed in putting the Roof Cover onto the Roof Panel. Make sure to pull the power cord through the corresponding hole in the Roof Cover. **See FIG 19**



**FIG 19** Slip the power cord through Roof Cover

15. Screw down the Roof Cover to the Roof.
16. Attach the door handle and screw into place. Screw cup-holder and magazine rack to the interior wall panel. (Cup-holder and/or magazine rack are not available on all models.)
17. Enter the sauna and remove the protective covering from the TEMPERATURE SENSOR. Situate the TEMPERATURE SENSOR so that it is vertical, pointing downward.



FIG 19

## Installation Completed.

### Operating the Sauna

**NOTE:** Before the sauna is turned on, remove plastic protective covering from the CONTROL PANELS. Please check and confirm that the connections to the POWER SUPPLY, HEAT EMITTERS, CD/RADIO, and TEMPERATURE SENSOR are connected properly. The power supply voltage and frequency must match the requested voltage and frequency of the sauna (120VAC 15AMP Dedicated Circuit or 120VAC 20AMP Dedicated Circuit).

Since many materials absorb the infrared rays, minimal clothing is recommended for maximum effect. The infrared sauna emitters are designed to heat you and not necessarily the air inside the sauna. It is not a hot box like a traditional sauna. The temperature gauge is a guide for your safety. It is recommended that you drink water before, during, and after sauna use to prevent dehydration since body fluids will be lost through perspiration. It is not recommended to shower after use since the pores in your skin will be open and could possibly absorb anything in the water.

1. Plug the sauna into the outlet receptacle.
2. Press the POWER button once. The POWER light will come on, the TIME DISPLAY will show 90 (minutes), the TEMPERATURE DISPLAY will show 66 (degrees Celsius), and the control panel will flash.
3. Press the up/down arrows under the TIME DISPLAY to adjust the amount of time you want the sauna to remain on. Press the C/F button to choose between Celsius and Fahrenheit. Press the up/down arrows under the TEMPERATURE DISPLAY to adjust the temperature setting. Once you have set these adjustments to the desired settings, press the START/WORK button. If you don't press the button for 5 seconds, the control panel will stop flashing and the set-up values will be memorized. The WORK and HEAT lights will now be on and the emitters will now be generating heat. You will need to pre-heat the sauna room to the set temperature before entering. Please keep in mind that you will increase the time it takes for the sauna room to reach the set temperature if you enter the sauna room before it has reached the set temperature.

4. During your sauna session, set-up time will count down the minutes one by one. When the time remaining is 5 minutes, the buzzer will make a warning sound for approximately 15 seconds letting you know you only have 5 minutes remaining. At this point, you can let the time run out or adjust the time by pressing the up/down arrows under the TIME DISPLAY. If you do choose to adjust the time, the control panel will flash and the emitters will stop generating heat. Once you set the time to the desired setting, then press the START/WORK button twice and the control panel will stop flashing and heat will began coming from the emitters once again.
5. Heating times do vary. Generally, it will take approximately twenty to thirty minutes to preheat the sauna to 50 degrees Celsius / 122 degrees Fahrenheit. When the ambient temperature is low, heating requires additional time. For the first few times of use, you may use 46 degrees Celsius / 115 degrees Fahrenheit as a reference starting point for a time period of about 15 minutes (this represents the actual time you are in the sauna at the desired temperature). As you become more comfortable and familiar with the sauna, you can increase the temperature and time period according to personal preference.
6. When the temperature is at the set-up value, the digital control will maintain the set temperature. The WORK light will remain on and the HEAT light will turn off. The emitters will stop generating heat. Once the inside temperature drops approximately 4 degrees, the HEAT light will turn back on and heat will again be generated by the emitters. With the digital control, the inside temperature will always remain around the set-up value.
7. Reading lamps and/or roof lamps and/or color therapy lamps are operated by pressing the respective buttons located towards the center of the control panel. These lamps are offered on some models and are not available on all models.
8. **Chromotherapy/Color Therapy Lighting (optional)** can be operated as follows. First, you will need to install the battery. Once the battery has been inserted into the remote, you are ready to operate the chromotherapy/color therapy lighting system. Press the READING LIGHT button on the sauna control panel. The white light will come on. While pointing the remote at the ceiling light, you can press any of the colors on the remote and that color will be displayed. You can use the SHADE button on the remote to go through a sequence of colors. If you want to turn the light off during your sauna session, you can press the POWER button on the remote. **Please note: You must be inside the sauna room for the remote to work. Remote may vary in appearance.**





**Power On/Off:** Press to control the main power of the sauna

**Power Indicator:** Indicates the status of the sauna's main power

**Work Start/Stop:** Press to control the working functions of the sauna

**Work Indicator:** Indicates the working status of the sauna

**Heat Indicator:** Indicates the status of heating function

**Light:** Press to control the lighting function

**Time Display:** Displays the heating time of the sauna in minutes

**Time:** Press to adjust the setting of the timer

**Temperature Display:** Displays the actual interior temperature of the sauna room in °C/°F

**Temperature:** Press to adjust the temperature setting

**°C/°F:** Press to change the temperature display between °C/°F

**Pictures shown are for representation only and may not resemble your exact model.**

## Tips for using Your Sauna

- 1) If you take a hot/warm shower or bath before using your sauna, you may perspire more and experience more comfort.
- 2) Drink water prior to, during, and after your sauna session to replenish body fluids.
- 3) To regulate the set temperature inside the sauna to your comfort level, use the movable roof ventilation or leave the door open slightly. The roof ventilation is installed on the sauna and used based on personal preference.
- 4) Use 2 or 3 towels during your sauna session. Fold one of the towels several times and place it on the bench. This towel will absorb some of your perspiration while adding comfort as you sit on the bench. Place another towel on the floor to absorb perspiration as it falls from your body (only on Ceramic Model Saunas). Be sure not to place any towels over the floor heat emitters. Use a third towel to wipe perspiration from your body from time to time.
- 5) At the first sign of a cold or flu, increasing your sauna sessions may be beneficial in boosting your immune system and decreasing the reproductive rate of viruses.
- 6) To help relieve sore and tense muscles, massage the affected areas during your sauna session.
- 7) To treat your ankles and feet more effectively, you can elevate them and move them close to one of the heat emitters to achieve a deep heating effect.

- 8) To utilize the sauna's heat therapy effect, put oil or treatment into your hair and wrap it with a towel. After your sauna session is over, rinse your hair thoroughly. Please follow the product directions for the intended benefits.
- 9) The peaceful and relaxed state rendered by a sauna session may help you to sleep easier and deeper.
- 10) To conserve energy consumption, please unplug your sauna when not in use.
- 11) After the sauna session is over, do not jump into the shower or bath immediately. Because your body was heated up during the sauna session, it will continue to perspire even after the heat emitters are off. Sit in the sauna with the door open slightly and let your body cool down. Once your body has cooled down and you feel comfortable, you can exit the sauna. After about twenty minutes and when your body has completely cooled down, you can take a shower to rinse the perspiration off your body.

## Safety Instructions

- 1.) Read and follow all instructions carefully before using the sauna.
- 2.) When installing and using the electrical equipment, safety precautions should always be followed.
- 3.) To reduce the risk of injury, do not allow children to use the sauna unless they are closely supervised at all times by an adult.
- 4.) Do not use the sauna immediately following strenuous exercises. Wait at least 30 minutes to allow the body to cool down completely.
- 5.) Pregnant or possibly pregnant women should contact their physician prior to using the sauna. Excessive temperature has a high potential for causing fetal damage during pregnancy.
- 6.) **Hyperthermia Danger:** the normal body temperature can't rise above 39°C (103°F). Symptoms of excessive hyperthermia include dizziness, lethargy, drowsiness, and fainting. The effects of excessive hyperthermia may include failure to perceive heat, physical inability to exit sauna, unawareness of impending hazard, unconsciousness and fetal damage in pregnant women. Hyperthermia could make your body's core temperature rise. Setting desired temperature to an excessively high temperature is not recommended.
- 7.) The use of alcohol, drugs, or medications prior to or during the sauna session may lead to unconsciousness and/or other harmful physical injuries.
- 8.) Persons suffering from obesity or with a medical history of heart disease, low or high blood pressure, circulatory system problems, or diabetes should consult a physician prior to using the sauna.
- 9.) Persons using medications should consult a physician before using the sauna. Some medications may induce drowsiness while others may affect the heart rate, blood pressure, and/or blood circulation.
- 10) Exercise care before and after sauna use.
- 11) Never sleep inside the sauna.
- 12) Do not use any type of cleaning agents on the interior of the sauna. Only wipe down with a cloth and water.
- 13) Do not stack or store any object on top or inside the sauna.
- 14) If the power supply cord becomes damaged, it must be replaced immediately by the manufacturer or its agent. If you find the power cord is too hot or that the electrical equipment may be experiencing technical problems, please contact the manufacturer or its agent immediately to avoid hazardous conditions.
- 15) Do not use the sauna during an electrical storm to avoid risk of shock.



- 16) Do not continuously switch the power on and off as it will compromise the life of the electrical components.
- 17) Your hands must be dry and free of moisture before plugging and unplugging cords and wiring harnesses from the power supply and circuit boards. Never operate the sauna with wet hands or wet feet to avoid risk of electric shock. Never touch the metal prongs of the plug.
- 18) Do not attempt to make any repairs yourself. If a problem occurs with the sauna, please contact seller, distributor, or the manufacturer to avoid safety risks. Unauthorized repair attempts will void the manufacturer's warranty.
- 19) Please make sure the outlet power supply meets the specifications required. Failure to meet the requirements may cause safety risks.
- 20) Some sauna models are equipped with reading and roof lamps. Because the lamp temperature will become very hot once powered on, do not attempt to touch the lamp to avoid being burned. Do not attempt to touch it for at least 20 minutes after it has been powered off.
- 21) Do not pour water or any other liquids on the infrared emitters. Do not bump, hit, or break the heating elements as it may cause an electrical short and pose a safety risk.
- 22) Do not make any modifications to the sauna, the sauna structure, or the sauna components.
- 23) Prior to each sauna session, the sauna room is to be inspected for correct operation. If for any reason your sauna room does not seem to be operating properly, discontinue use and contact the manufacturer.

## Safeguards For Your Sauna

1. Do not install the sauna near water, near a bathtub, near a shower, in a wet basement, or near a swimming pool.
2. Do not use liquid cleaners or aerosol cleansers inside the sauna. Unplug the sauna from the wall outlet before cleaning. Use plain water and a soft cloth for cleaning.
3. The power supply cord should be routed so that it is not walked on or pinched by any object that may be placed against it.
4. When replacement parts are required, be sure they meet the specified requirements of the manufacturer. Unauthorized substitutes may result in fire, electric shock, or other hazardous conditions. After any repairs, please ask the service technician to perform safety checks to determine that your sauna is working properly.
5. Do not use any wall receptacle adapter or extension cord between the sauna cord and wall receptacle.

## Troubleshooting Guide

### 1. No Heat Coming From Some Of The Heat Emitters

**Solution:** Check to make sure all the heat emitter cords are properly connected, including the cord to the heat emitter underneath the bench (if applicable). Go to the roof, and also check that the heat emitter cords are

properly connected to the cords on the roof and that those cords are properly plugged into the power supply.

**Solution:** If some of the heat emitters are working, then the ones which are not working may have been damaged. Do not continue to operate. Contact the manufacturer for replacement parts.

**Solution:** If the heat emitters are not working but the control panel displays the time and temperature, then the temperature sensor may not be plugged in properly or it may be damaged. Turn the control panel off and then go to the roof of the sauna and locate the red and black wires near the air vent towards the rear of the sauna. After you have located the red and black wires labeled “TEMP SENSOR”, disconnect them. Connect the spare temperature sensor. For testing purposes, insert the “TEMP SENSOR” (you just connected) down the vent on the roof so that it is now inside the sauna. Then go to the control panel and press the power button. If the heat emitters now have heat, then the “TEMP SENSOR” was the cause of the problem. You may have to wait about five minutes to confirm if the heat emitters are generating heat. Remove the original temperature sensor from its hole and replace it with the spare one.

## 2. Control Panel Malfunctioning

**Solution:** The control panel will turn on, but not off and the displayed numbers flash. The issue may be a connection problem. Go up to the roof and locate the “CTRL” wire harness you connected when the roof was installed onto the sauna room. Disconnect the “CTRL” wire harness, check the pins to make sure they are straight and not bent, and firmly reconnect the “CTRL” wire harness. Attempt to turn the sauna on at the control panel and check to see if the buttons are now responding. Contact the manufacturer for any additional troubleshooting.

**Solution:** The control panel will not turn off, the power/work/or heat lights do not come on, or the temperature and timer buttons do not work means the control panel may have been damaged and will need to be replaced. Contact the manufacturer for additional troubleshooting.

## 3. Sauna Shows Signs Of No Power

**Solution:** There could be one of a few problems causing this. First, check to see if the cord from the power supply is plugged into the wall outlet. Also check your main circuit breaker to confirm that it has not tripped. Check the power supply on the roof of the sauna to make sure there are no signs of malfunctioning, such as a high temperature, burning odor, or strange sounds. Also, check to make sure none of the power cords are damaged. If the power supply is malfunctioning or power cords are damaged, then unplug the sauna immediately and contact the manufacturer.

**Solution:** If your sauna is plugged in and you have no power at the control panel, then the power supply may need to be reset. Go to the roof of the sauna and locate the power supply. Press the

RESET button to reset the power supply. The RESET button is on the same side of the power supply as all the heater cord connections. Attempt to turn the sauna on at the control panel. Contact the manufacturer for any additional troubleshooting.

**Solution:** There could be damage to the temperature sensor. If your sauna arrived with a spare temperature sensor, turn the control panel off and go to the roof of the sauna and locate the red and black wire near the air vent towards the rear of the sauna. After you have located the red and black wires labeled "TEMP SENSOR", disconnect them. Connect the spare temperature sensor. For testing purposes, insert the "TEMP SENSOR" (you just connected) down the vent on the roof so that it is now inside the sauna. Then go to the control panel and press the power button. If the heat emitters now heat, then the temperature sensor was the cause of the problem. You may have to wait about five minutes to confirm if the heat emitters are generating heat. Remove the original temperature sensor from its hole and replace it with the spare one.

**Solution:** Check the wiring harnesses coming from the power supply located on the roof of the sauna. Make sure the wiring harness labeled "CTRL" is connected to the power supply at one end and connected to another wiring harness labeled "CTRL" at the other end. If this wiring harness is not properly connected, then the sauna will show signs of having no power.

## Limited Lifetime Warranty

**5 Year Limited Warranty:** Golden Designs, Inc. warrants the wood, structure, heating elements, and electronics against defects in material and workmanship for a period of 1 to 5 years from the original date of purchase. **This sauna is for INDOOR use only. Placing your sauna outdoors will VOID this warranty. Any damage due to exposure to outdoor elements such as rain, snow, sun, wind or extreme temperatures will not be covered by this warranty. Any damages as a result of modifications made to the sauna or its components will void this warranty.**

---

**Extent of Warranty:** This limited warranty applies to products manufactured or distributed by Golden Designs, Inc. under the Dynamic brand name, delivered in the continental United States or Canada and extends to the original purchaser at the original site of installation only. This warranty becomes valid at time of purchase and terminates either by specified time frame listed above, owner transfer, or relocation. **Your sales receipt showing the date of purchase of the product is your proof of purchase.**

### Manufacturer Warranty

All Golden Designs, Inc. products are manufactured with the highest quality appliances and are warranted to be free from defects in material and workmanship at the time of delivery. The appliance warranty is extended through the manufacturer for the product including, but not limited to: stereos, CD/DVD players, etc. All exchanged parts and products replaced under this warranty will become the property of Golden Designs, Inc. Golden Designs, Inc. reserves the right to change manufactures of any part to cover any existing warranty. Any parts determined to be defective must be returned to Golden Designs, Inc. to obtain warranty service. You must prepay any shipping charges, export taxes, custom duties and taxes, or any other charges associated with the transportation of the parts. In addition you are responsible for insuring any parts shipped or returned. You must present Golden Designs, Inc. with proof of purchase documents (including the date of purchase). Any evidence of alteration, erasing or forgery of proof of purchase documents will be cause to **VOID** this limited warranty. Products on which the serial number has been defaced or removed is not eligible for warranty service.

### Warranty Limitations

This warranty does not apply if the unit has been subject to negligence, alteration, modification, misuse, abuse, repairs by non-Golden Designs, Inc. authorized personnel, inappropriate installations, or any case beyond the control of Golden Designs, Inc. invalidating this warranty including but are not limited to:

- Use of lacquer or paints
- Sauna and other Golden Designs, Inc. products accessories placed on non-approved surfaces
- Outdoor applications
- Normal wear and tear or weathering
- Use of product not in accordance with instructions

**Surface cracks are not considered defects in material or workmanship, as they are normal characteristics of all woods. This includes minor cracks due to wood expansion and contraction. Note: Since the wood used in construction has been kiln dried, a certain amount of expansion and contraction occurs in the wood in a sauna environment.**

### **Disclaimers**

Golden Designs, Inc. shall not be liable for loss of use of sauna or other Golden Designs, Inc. products or other secondary or incidental or consequential costs, expense or damages - which may include the removal of permanent deck or other custom fixtures or the necessity for crane removal - arising directly or indirectly out of the use or inability to use the product. Any implied warranty shall have duration equal of the applicable warranty stated above. Under no circumstances shall Golden Designs, Inc. or any of its representatives be held liable for injury to any person or damage to any property, however arising. Specifications are subject to change without notice or obligation.

### **Legal Remedies**

This limited warranty gives you specific legal rights. You may have other rights, which may vary from state to state.

### **Customer Service**

For customer service, contact your authorized dealer. If you need additional information or assistance, please email Golden Designs, Inc. at [info@goldendesignsinc.com](mailto:info@goldendesignsinc.com) or call (909) 212-5555.

\*Limited Lifetime Warranty of Sauna Products is 5 years on heating elements and electronics from the date of purchase. The radio and wood structure have a 1 year limited warranty.

**Page  
Intentionally  
Left  
Blank**

**WARRANTY CARD**

Congratulations on your purchase of an Infrared Sauna from Golden Designs, Inc. Please take the time to complete the following Warranty Card and mail it back to:

**Golden Designs, Inc.  
3550 Jurupa Street, Unit B  
Ontario, CA 91761**

Please include a copy of your sales receipt showing date of purchase as this will serve as proof of purchase.

**Warranty will be VOID if the following warranty card is not mailed back within 60 days of purchase date along with proof of purchase.**

**\*\*Serial number (S/N) is located on the sauna's front panel, rear panel, or on the carton.\*\***

DETACH HERE



**WARRANTY CARD**

All fields must be completed to validate the warranty. Name: \_\_\_\_

Address: \_\_\_\_\_

City: \_\_\_\_\_ State: \_\_\_\_\_ Zip Code: \_\_\_\_\_

Phone Number: \_\_\_\_\_

Purchase Date: \_\_\_\_\_

Purchase From: \_\_\_\_\_

Serial Number: \_\_\_\_\_