

# 8000BTU AIR CONDITIONER



**BTU**  
8000

**WEIGHT**  
22KG

**TIMER**  
24 HOURS

**WARRANTY**  
365 DAYS

**Thank you for purchasing this NETTA product.**

Please read the user manual carefully before operating this appliance.

We will update our instruction manuals if necessary.

For the most up-to-date user manual, please visit our official website: [www.nettadirect.com](http://www.nettadirect.com).

You can download a copy of up-to-date user manuals at any time in electronic format. We do not supply you with a paper-based user manual after each revision.

**Require a larger version of this  
Instruction Manual?**

**Please download electronically  
from our website and use PDF  
reader on your device to enlarge  
the text if needed.**

**[www.nettadirect.com](http://www.nettadirect.com)**

## Safety and Warnings

### Intended Use

NETTA Design is for domestic and indoor use only. This product is not intended for use by people who have lack of experience and knowledge or have reduced ability, or sensory and metal capabilities.

### Regular Check-Ups

Ensure the power cable and plug are not damaged before plugging into a socket.

Check all the buttons are functioning correctly.

## General Warnings

- To prevent death or injury to the user or other people and property damage, the following instructions must be followed. Incorrect operation due to ignoring the instructions may cause death, harm or damage.
- Installation must be performed according to the installation instructions. Using non-standard parts can cause water leakage, electrical shock, fire, injury and/or property damage.
- Make sure that the outlet you are using is grounded and has the appropriate voltage. The power cord is equipped with a three-prong grounded plug to protect against shock. Voltage information can be found on the nameplate of the unit.
- Your unit must be used in a properly grounded wall receptacle. If the wall receptacle you intend to use is not adequately grounded or protected by a time delay fuse or circuit breaker, have a qualified electrician install the proper receptacle.
- Install the unit on a flat, sturdy surface. Failure to do so could result in damage or excessive noise and vibration.
- The unit must be kept free from obstruction to ensure proper function and to mitigate safety hazards.
- Do not modify the length of the power cord or use an extension cord to power the unit.
- Do not share a single outlet with other electrical appliances. Improper power supply can cause fire or electrical shock.
- Do not install your air conditioner in a wet room such as a bathroom or laundry room. Too much exposure to water can cause electrical components to short circuit.
- Do not install the unit in a location that may be exposed to combustible gas as this could cause fire.

## General Warnings

- This unit has wheels to facilitate moving. Make sure not to use the wheels on thick carpet or to roll over objects, as these could cause tipping.
- Do not operate the unit if it has been dropped or damaged.
- Do not touch the unit with wet or damp hands or when barefoot.
- If the air conditioner is knocked over during use, turn off the unit and unplug it from the main power supply. Visually inspect the unit to ensure there is no damage. If you suspect the unit has been damaged, contact our customer service team.
- In a thunderstorm, the power must be cut off to avoid damage to the machine due to lightning.
- Your air conditioner should be used in such a way that it is protected from moisture e.g., condensation, splashed water, etc. Do not place or store your air conditioner where it can fall or be pulled into water or any other liquid. Unplug immediately if this occurs.
- All wiring must be performed strictly in accordance with the wiring diagram located inside of the unit.
- The unit's circuit board is designed with a fuse to provide overcurrent protection. The specifications of the fuse are printed on the circuit board.
- When the water drainage function is not in use, keep the upper and lower drain plug firmly in the unit to get rid of choking. When the drain plug is not in use, keep it away from children to prevent choking.
- This appliance can be used by children aged from 8 years and above and people with reduced physical, sensory or mental capabilities or lack of experience and knowledge if they have been instructions concerning the use of the appliance in a safe way and are supervised. Children shall not play with the appliance. Cleaning and user maintenance shall not be made by children without supervision.
- If the supply cord is damaged, it must be replaced by the manufacturer, its service agent or similarly qualified people to avoid a hazard.
- Prior to cleaning or other maintenance, the appliance must be disconnected from the supply mains.
- Do not remove any fixed covers. Never use this appliance if it not working properly, or if it has been dropped or damaged.
- Do not run the power cord under carpeting. Do not cover the cord with rugs, runners or similar coverings. Do not route the cord under furniture or appliances. Arrange the cord away from busy areas to avoid accidents and injuries.
- The appliance shall be installed in accordance with national wiring regulations.

## General Warnings

- Contact an authorised service technician or our customer service team for repair or maintenance of this unit.
- Do not cover or obstruct the inlet or outlet grilles.
- Do not use this product for functions other than those described in this instruction manual.
- Before cleaning, turn off the power and unplug the unit.
- Disconnect the power if strange sound, smells, or smoke come from the unit.
- Do not press the buttons on the control panel with anything other than your fingers.
- Do not remove any fixed covers. Never use this appliance if it is not working properly, or if it has been dropped or damaged.
- Do not operate or stop the unit by inserting or pulling out the power cord plug.
- Do not use hazardous chemicals to clean the unit. Do not use the unit in the presence of flammable substances or vapour such as alcohol, insecticides, petrol, etc.
- Always transport your air conditioner in a vertical position and stand on a stable, level surface during use.
- Always contact a qualified person to carry out repairs. If the damaged power supply cord must be replaced with a new power supply obtained from the product manufacturer.
- Hold the plug by the head of the power plug when taking it out.
- Turn off the product when not in use.
- Do not use means to accelerate the defrosting process.
- The appliance shall be stored in a room without continuously operating ignition sources e.g., open flames, electric heaters, etc.
- Do not pierce or burn.
- Be aware that the refrigerants may not have an odour.
- Compliance with national gas regulations shall be observed. Keep ventilation openings clear of obstruction.
- The appliance shall be stored so as to prevent mechanical damage from occurring.
- Servicing shall only be performed as recommended by the equipment manufacturer. Maintenance and repair requiring the assistance of other skilled personnel shall be carried out under the supervision of a person competent in the use of flammable refrigerants.





## General Warnings

- Please follow the instruction carefully to handle, install, clean and service the air conditioner to avoid damage or hazards. Flammable refrigerant is used within this air conditioner. When maintaining or disposing of the air conditioner, the refrigerant shall be recovered properly and not discharged into the air directly.
- If repairing or maintaining this unit, all maintenance staff and others working in the area must be instructed on the nature of the work being carried out. Work in confined spaces shall be avoided. The area around the workspace should be sectioned off. Ensure that the conditions within the area have been made safe by control of flammable materials.
- The area shall be checked with an appropriate refrigerant detector prior to and during work to ensure the technician is aware of potentially flammable refrigerants.
- Keep all possible ignition sources, including cigarette smoking, away from the site of the work.
- Ensure that the area is in the open or adequately ventilated before starting any work.
- Where electrical components are being changed, they shall be fit for purpose and to the correct specification. The manufacturers maintenance and service guidelines shall be followed at all times.
- Repair and maintenance to electrical components shall include initial safety checks and component inspection procedures. If a fault exists that could compromise safety, then no electrical supply shall be connected to the circuit until it is satisfactorily dealt with.
- Ensure that cabling will not be subject to wear, corrosion, excessive pressure, vibration, sharp edges or any other adverse environmental effects. The check shall also consider the effects of aging or continual vibration from sources such as compressors or fans.
- Under no circumstance shall potential sources of ignition be used in the searching for or detection of refrigerant leaks. Halide torches or any other detector using a naked flame shall not be used.



Caution: Risk of fire/  
flammable materials  
(Required for R32/R290 units only)

Explanation of symbols displayed on the unit (For the unit adopts R32/R290 Refrigerant only):

	WARNING	This symbol shows that this appliance used a flammable refrigerant. If the refrigerant is leaked and exposed to an external ignition source, there is a risk of fire.
	CAUTION	This symbol shows that the operation manual should be read carefully.
	CAUTION	This symbol shows that a service personnel should be handling this equipment with reference to the installation manual.
	CAUTION	This symbol shows that information is available such as the operating manual or installation manual.

## Assembling the Product

Note: All illustrations in the manual are for explanation purpose only. Your machine may be slightly different. The unit can be controlled by the unit control panel or with the remote controller. This manual does not include remote controller operations. Please see the remote controller instruction manual packed with the unit for these details.

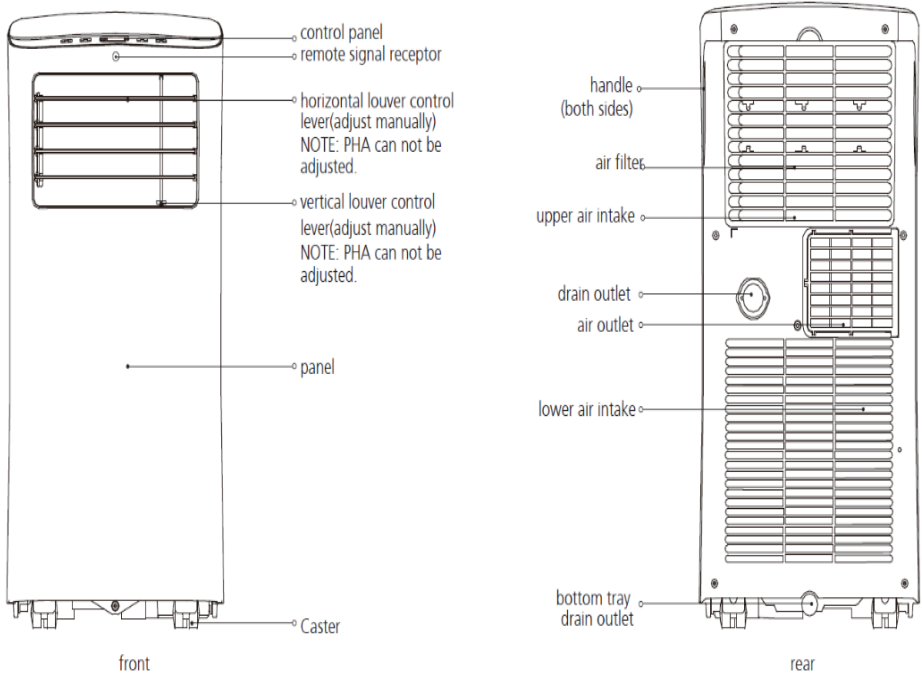

## Exhaust Hose Installation

The exhaust hose and adaptor must be installed or removed in accordance with the usage mode. For 'COOL' or 'AUTO' mode, the exhaust hose must be installed. For 'FAN' or 'DRY' mode, the exhaust hose must be removed.



## Choosing The Right Location

Make sure you install your unit on an even surface to minimise noise and vibration.

The unit must be installed near a grounded plug and the collection tray drain (found on the back of the unit) must be accessible.

The unit should be located at least 30cm (12 inch) from the nearest wall to ensure proper air conditioning. The horizontal louver blade should be at least 50cm (19.7 inch) away from obstacles.

Do not cover the intakes, outlets or remote signal receptor of the unit, as this could cause damage to the unit.

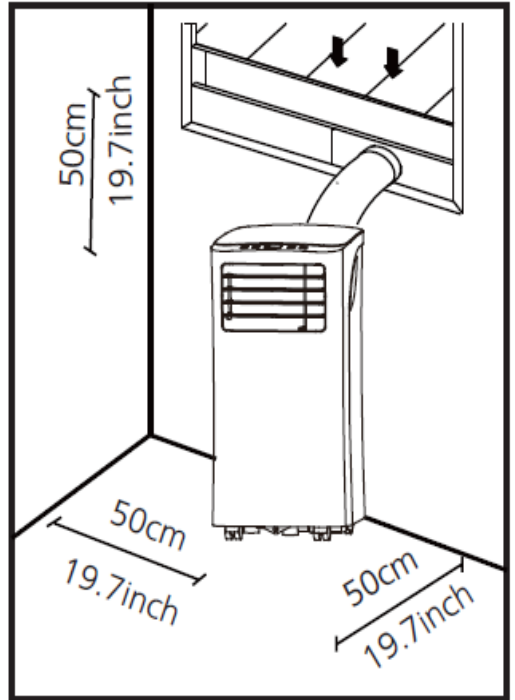

## Recommended Installation

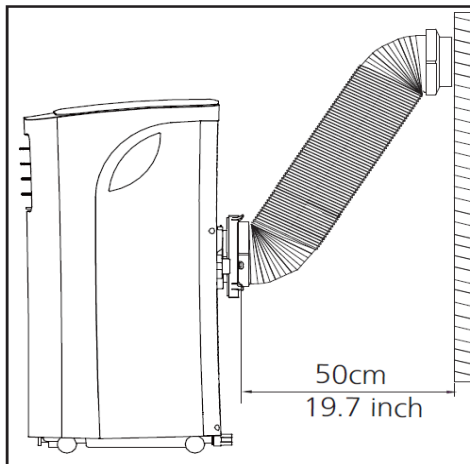





















## Tools Needed

Medium Philips Screwdriver, Tape Measure/Ruler, Knife/Scissors, Saw (optional, to shorten window adaptor).

## Accessories

Note: Items with (\*) are only on some models.

Shape	Name of Accessories	Qty.	Shape	Name of Accessories	Qty.
	Unit Adaptor	1 pc		Window Sliders	1 set(*)
	Exhaust Hose	1 pc		Security Bracket and 2 Screws	1 set(*)
	Window Slider Adaptor	1 pc(*)		Drain Hose	1 pc
	Window Slider A	1 pc(*)		Bolt	1 pc(*)
	Window Slider B	1 pc(*)		Remote Controller and Battery (only for remote control models)	1 set(*)
	Foam Seal A (Adhesive)	2 pc(*)		Wall Exhaust Adaptor A (only for wall installation models)	1 pc(*)
	Foam Seal B (Adhesive)	2 pc(*)		Wall Exhaust Adaptor B (with cap) (only for wall installation models)	1 pc(*)
	Foam Seal C (Non-adhesive)	1 pc(*)		Screw and anchor (only for wall installation models)	4 set(*)
	Drain Hose Adaptor (only for heat pump mode)	1 pc(*)		Extended Exhaust Hose	1 pc(*)
	Exhaust Hose Adaptor	1 pc(*)		Air exhaust passage	1 pc(*)

## Window Installation Kit

Step One: Preparing the Exhaust Hose Assembly.

Press the exhaust hose (or extended exhaust hose) into the window slider adaptor (or wall exhaust adaptor) and unit adaptor. This will automatically clamp due to the elastic buckles of the adaptors.

(See next page for example illustrations).

## Type window installation:

Model A

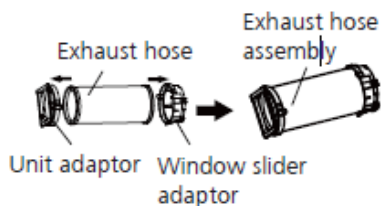

Model B

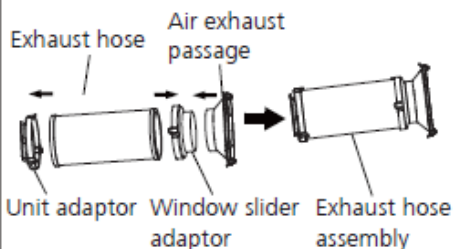

Model C

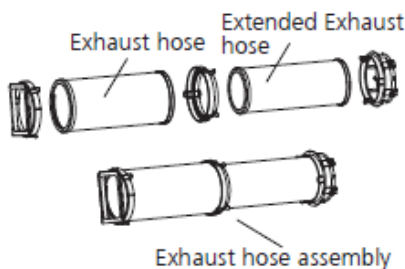

Model D

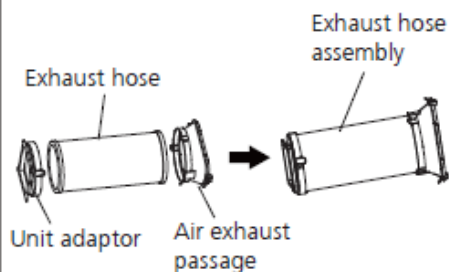

## Type wall installation:

Model A

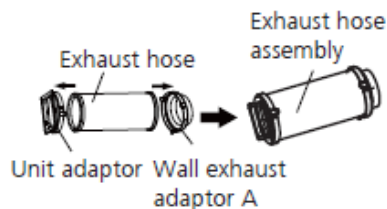

Model B

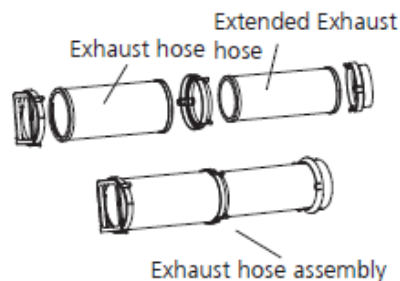

## Step Two: Install the Exhaust Hose Assembly to the Unit.

Push the Exhaust Hose into the air outlet opening of the unit along the arrow direction.



## Step Three: Preparing the Adjustable Window Slider

1. Choose the window sliders according to the size of your window. Sometimes, it needs to be cut short to meet the window size. Please take extra care to cut it properly.
2. Use bolts to fasten the window sliders once they are adjusted to the proper length.

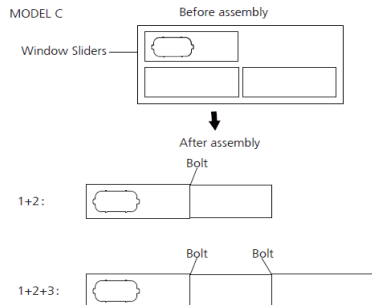
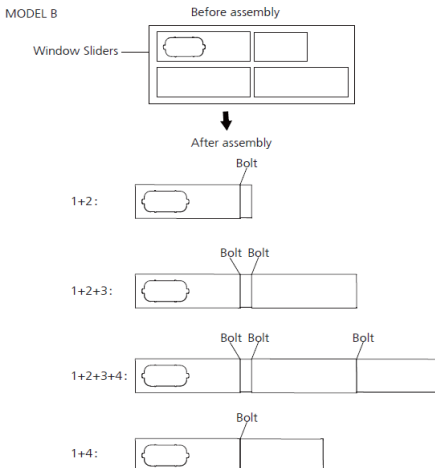
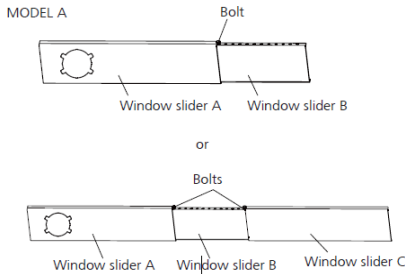

## Installation

Once the Exhaust Hose assembly and Adjustable Window Slider are prepared, choose from one of the following two installation methods.

### Type 1: Hung Window or Sliding Window Installation

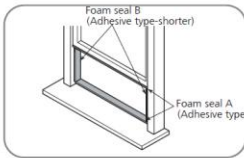

Or

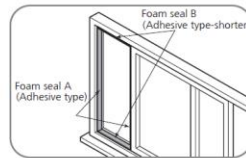

1. Cut the adhesive foam seal A and B strips to the proper lengths, and attach them to the window sash and frame as shown.

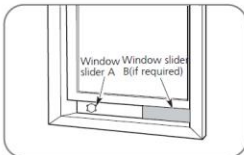

Or

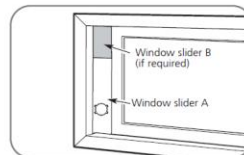

2. Insert the window slider assembly into the window opening.

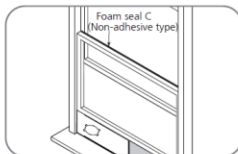

Or

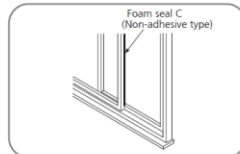

3. Cut the non-adhesive foam seal C strip to match the width (or height) of the window. Insert the seal between the glass and the window frame to prevent air and insects from getting into the room.

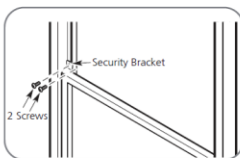

Or

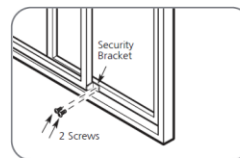

4. If desired, install the security bracket with 2 screws as shown.

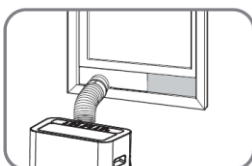

Or

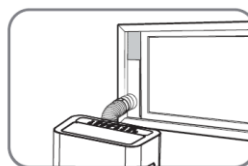

5. Insert the window slider adaptor into the hole of the window slider.

## Type 2: Wall Installations (for some models).

1. Cut as 125mm (4.9 inch) hole into the wall for the Wall Exhaust Adaptor B.
2. Secure the Wall Exhaust Adaptor B to the wall using the four anchors and screws provided in the kit.
3. Connect the Exhaust Hole Assembly (with Wall Exhaust Adaptor A) to the Wall Exhaust Adaptor B.

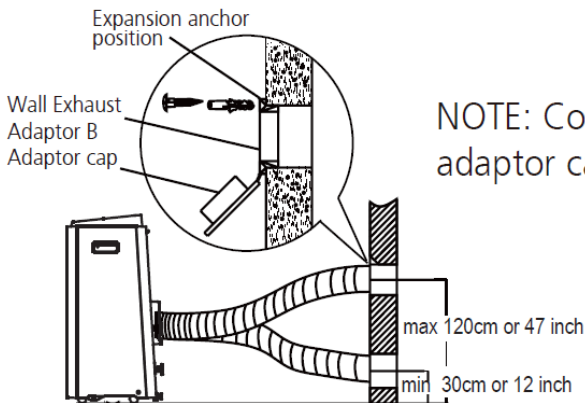

NOTE: Cover the hole using the adaptor cap when not in use.

Note: To ensure proper functionality, do not overextend or bend the hose. Make sure that there is no obstacle around the air outlet of the exhaust hose.



# Operating the Product

## Control Panel Features

Note: The following control panels are for explanation purposes only. The control panel of the unit you purchased may be slightly different according to the models. Your machine may not contain some indicators or buttons.

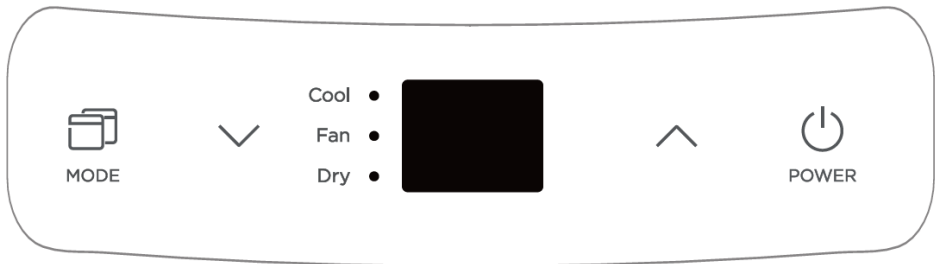

### Mode Button

Selects the appropriate mode. Each time you press the button, a mode is selected in a sequence that goes from COOL, FAN, DRY and AUTO. The mode indicator light illuminates under the different mode setting.

### Up (+) and Down (-) Buttons

Used to adjust the temperature settings in 1°C increments in a range from 17°C to 30°C.

Note: This unit can display temperatures in degrees Fahrenheit or degrees Celsius. To convert from one to the other, press and hold the Up and Down buttons at the same time for 3 seconds.

### Power Button

Switch the power on/off.

## LED Display

Shows the set temperature while on cool or auto mode. While on DRY or FAN modes, it shows the room temperature.

### **Error Codes:**

- E0 – EEPROM Error
- E1 – Room Temperature Sensor Error
- E2 – Evaporator Temperature Sensor Error
- E3 – Condenser Temperature Sensor Error (On Some Models)
- E4 – Display Panel Communication Error
- EC – Refrigerant Leakage Detection Malfunction (On Some Models)

### **Protection Codes:**

P1 – Bottom Tray is full – Connect the drain hose and drain the collected water away. If protection repeats, call customer service.

Note: When one of the above malfunctions occurs, turn off the unit, and check for any obstructions. Restart the unit, if the malfunction is still present, turn off the unit and unplug the power cord. Contact the customer service team.

## **Operation Instructions**

**Cool Operation** – Press the ‘MODE’ button until the ‘COOL’ indicator light comes on. Press ‘^’ OR ‘v’ buttons to select your desired room temperature. The temperature can be set within a range of 17°C to 30°C.

**Dry Operation** – Press the ‘MODE’ button until the ‘DRY’ indicator light comes on. The fan speed or the temperature cannot be adjusted. The fan motor operates at LOW speed. Note: Keep windows and doors closed for the best dehumidifying effect.

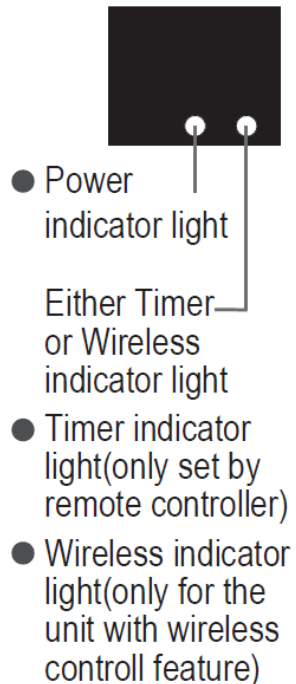



**Fan Operation** – Press the 'MODE' button until the 'FAN' indicator light comes on. Press the 'FAN SPEED' button on the remote controller to choose the fan speed. The temperature cannot be adjusted.

**Auto Operation** (On Some Models) – When you set the air conditioner in 'AUTO' mode, it will automatically select cool mode or fan mode depending on what temperature you have selected and the room temperature. The air conditioner will control the room temperature automatically round the temperature point set by you. Under 'AUTO' mode, you cannot select the fan speed.

Note: Under 'AUTO' mode, both the AUTO mode and the actual operation mode indicator lights illuminate for some models.

**Sleep Operation** – This feature can be activated from the remote control only. When the 'SLEEP' feature is activated, the set temperature will increase by 1°C after 30 minutes. The set temperature will then drop by another 1°C after an additional 30 minutes. This new temperature will be maintained for 7 hours before it returns to the originally selected temperature. This ends the 'SLEEP' mode and the unit will continue to operate as originally planned.

Note: This feature is unavailable under 'FAN' or 'DRY' mode.

**Auto-Restart** – If the unit shuts down unexpectedly due to a power cut, it will restart with the previous function setting automatically when the power resumes.

**Wait 3 Minutes Before Resuming Operation** – After the unit has stopped, operation cannot be restarted in the first 3 minutes. This is to protect the unit. Operation will automatically start after 3 minutes.

**Air Flow Direction Adjustment** – Adjust the air flow direction manually. The louver can be set to the desired position manually. Do not place any heavy objects on the louver, doing so will cause damage to the unit. Keep the louver fully opened during operation.

**Wireless Operation** (On Some Models) – Used to initiate wireless (Wi-Fi) connection mode. If using the wireless function for the first time, press the 'POWER' button for 3 seconds to initiate the wireless connection mode. The LED DISPLAY shows 'AP' to indicate you can set the wireless connection. If connection is successful within 8 minutes, the unit will exit wireless connection mode automatically and the wireless indicator illuminates. If connection is not made within 8 minutes, the unit exits wireless connection mode automatically.

After wireless connection is successful, for some models you can press MODE and 'UP'/'^' buttons at the same time for 3 seconds to turn off the wireless function and the LED DISPLAY shows 'OF' for 3 seconds. Repeat this and the LED DISPLAY will show 'ON' for 3 seconds.

Note: When you restart the wireless function, it may take a period of time to connect to the network automatically.

### **Download and Install the App**

The following QR code is only available for downloading the app. It is totally different from the QR code on the unit.



**Android**



**iOS**

Android Phone users: Scan the Android QR code or go to google play, search 'Nethome Plus' and download the app.

iOS users: Scan the iOS QR code or go to the app store, search 'Nethome Plus' and download the app.

## Preparation

Please ensure your mobile device is connected to Wi-Fi/Wireless router. Also ensure that the Wi-Fi/Wireless router is connected to the internet before doing user registration and network configuration.

Ensure your mobile device is connected to the Wi-Fi/Wireless network which you want to use. You should also forget other irrelevant Wi-Fi/Wireless networks in case it influences your configuration process.

## Create Account

Reminder: When you register to use the app, you need to read and agree the Data Privacy Notice.

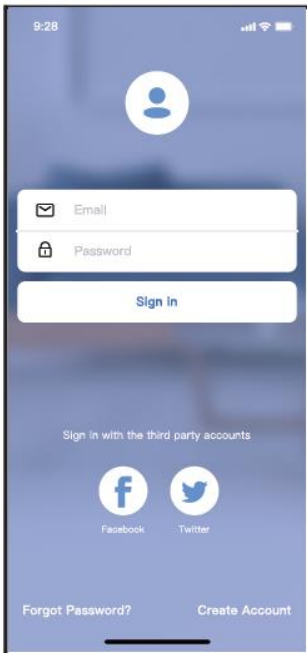

Android

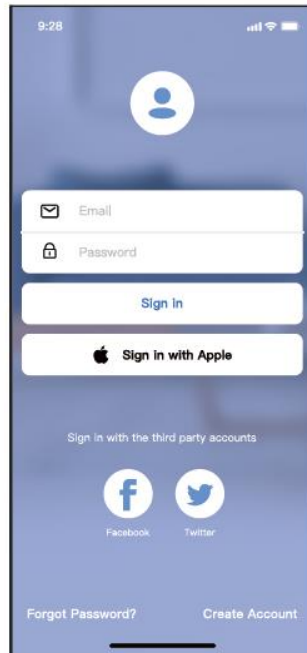

iOS

1. Click 'Create Account'.

2. Enter your email address and password, and then click 'register'.

## Network Configuration

It is necessary to forget any other networks and make sure the Android or iOS device is only connected to the Wi-Fi/Wireless network you want to add.

Make sure the Android and iOS device Wi-Fi/Wireless function works well and can be connected back to your original Wi-Fi/Wireless network automatically.

Reminder: User must finish all the steps in 8 minutes after powering the wireless function on the AC, otherwise you will need to restart the process.

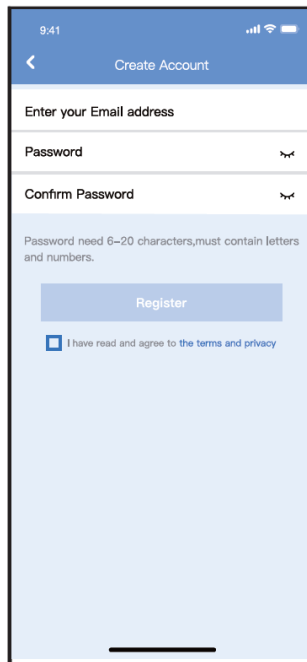

9:41 Create Account

Enter your Email address

Password

Confirm Password

Password need 6–20 characters,must contain letters and numbers.

Register

I have read and agree to the terms and privacy

## Using Android or iOS device to set up Network Configuration

Ensure your mobile device has already been connected to the Wi-Fi/Wireless network which you want to use. Also, you need to forget other irrelevant Wi-Fi/Wireless networks in case it influences your configuration process.

Disconnect the power supply of the AC unit.

Reconnect the power supply for the AC unit and active AP mode (see above steps under 'wireless operation').

When AP appears in the display, it means that the air conditioner is ready for a connection to be made.

There are two ways to finish the network configuration:

- Network configuration by Bluetooth scan.
- Network configuration by Select Appliance Type.

## Network Configuration by Bluetooth Scan

Note: Make sure the Bluetooth of your mobile device is on and working.

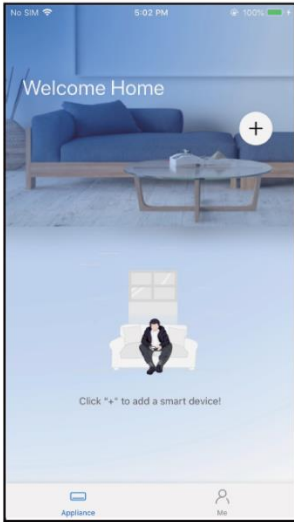

① Press “ + Add Device ”

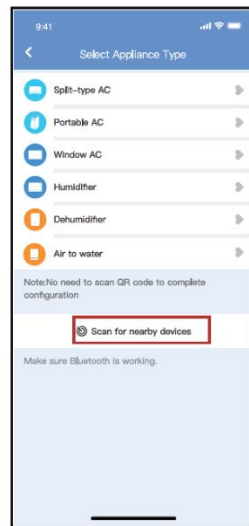
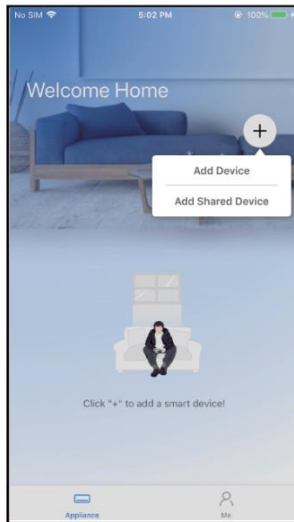

② Press “Scan for nearby devices”

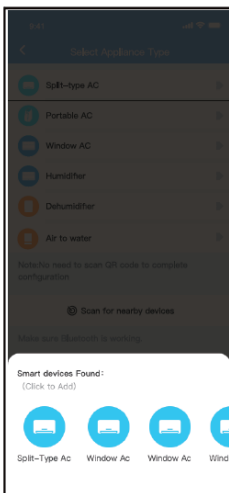

③ Wait smart devices to find, then click to add it

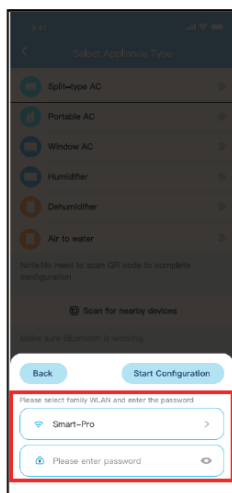

④ Select home Wi-Fi, enter the password

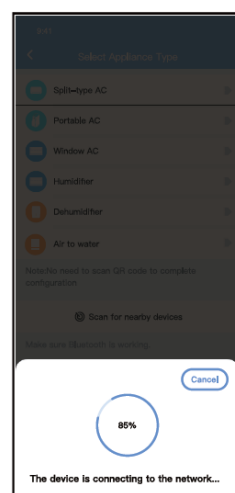

⑤ Wait connecting to the network

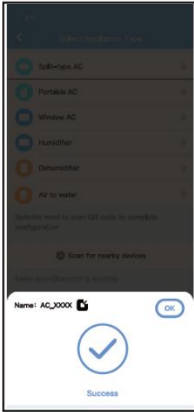

⑥ Configuration Success, you can see the device on the list, you can you can modify the default name.

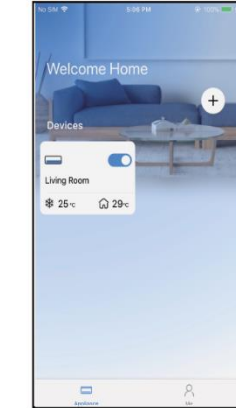

⑦ Bluetooth network configuration is successful, now you can see the device in the list.

## Network Configuration by Select Appliance Type

If the Bluetooth network configuration fails, please select the appliance type (Portable AC). Follow the above steps under 'wireless operation'. When the display shows 'AP', press 'next' on the app.

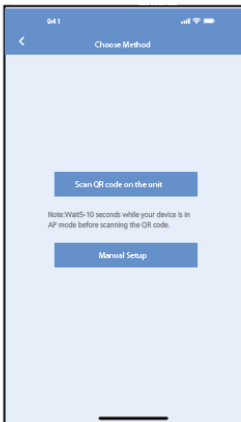

③ Choose the network configuration method.

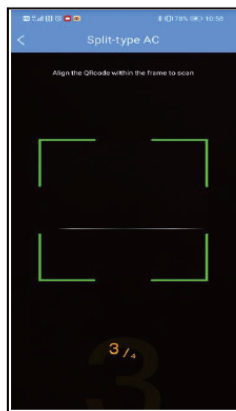

④ Choose the "Scan the QR code" method.

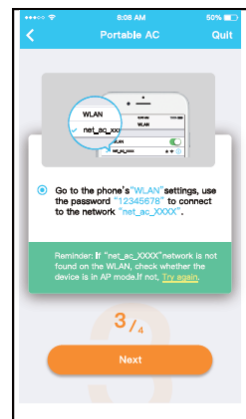

For Portable AC

Note: Steps 3 and 4 are only applicable to Android systems. iOS does not need these two steps.

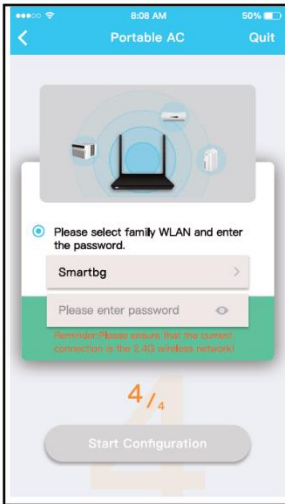

For Portable AC

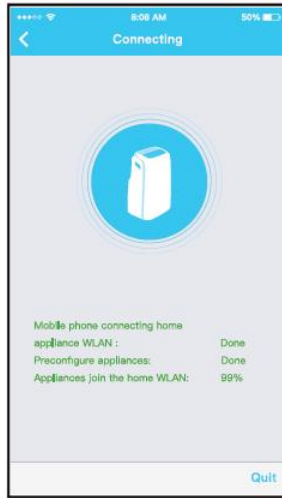

For Portable AC

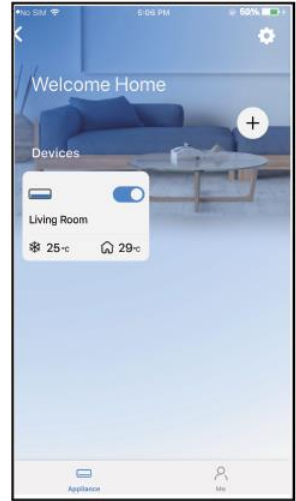

⑧ Configuration Success, you can see the device in the list.

Note: When finishing network configuration, the app will display success cue words on screen. Due to different internet environments, it is possible that the device status will still display 'offline'. If this occurs, please pull down on the screen to refresh the device list on the app. Alternatively, you can turn off the power of the unit and turn it back on. The device status will change to 'online' after a few minutes.

## How To Use The App

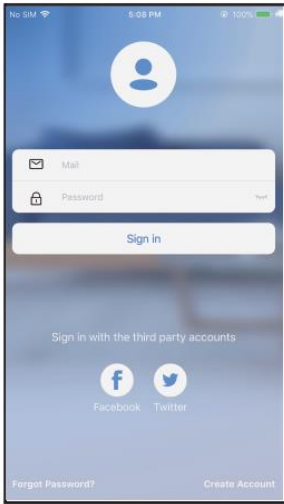

① Click "Sign in"

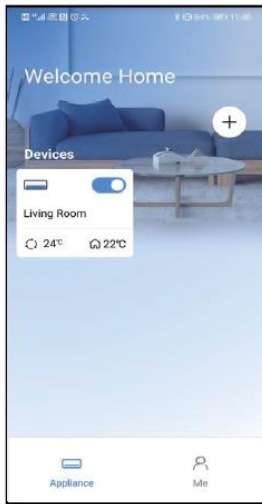

② Choose the air conditioner.

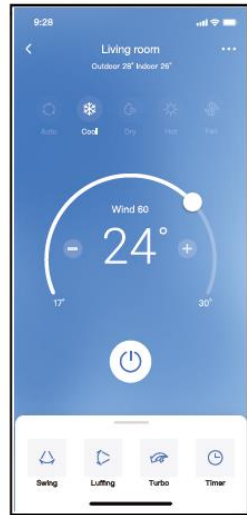

③ Thus, user can control air conditioners on/off status, operation mode, temperature, fan speed and so on.

Note: Not all of the app functions are available on the air conditioner.

## Schedule

The user can set a weekly timer to turn the AC on/off.

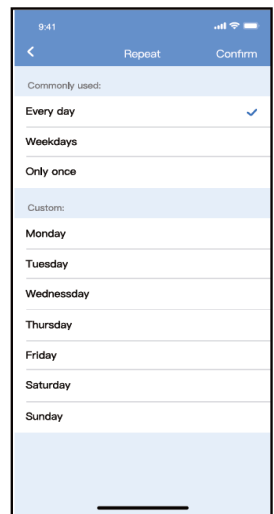
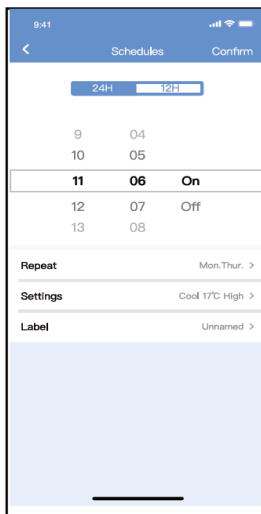
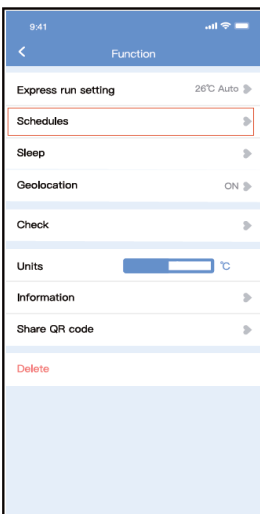



## Sleep

The user can customise their own comfortable sleep by setting a target temperature.

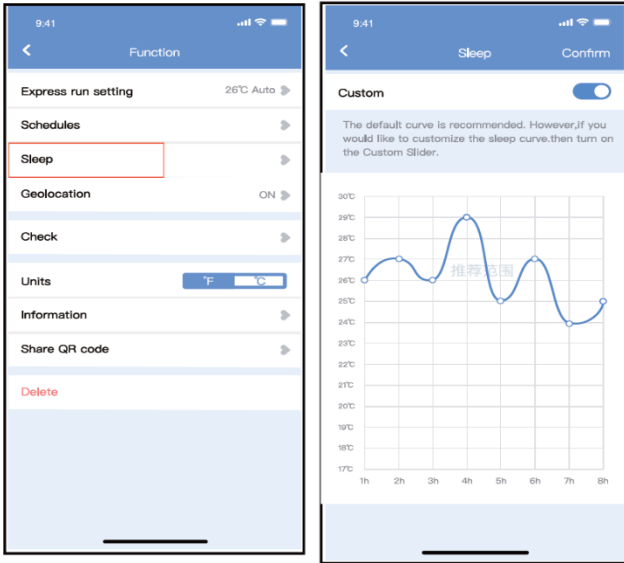

## Share Device

The air conditioner can be controlled by multiple users at the same time.

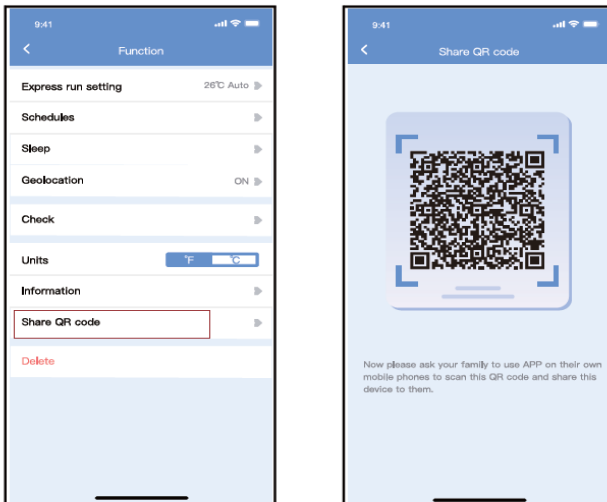

① Click "Share QR code"

② QR code display.

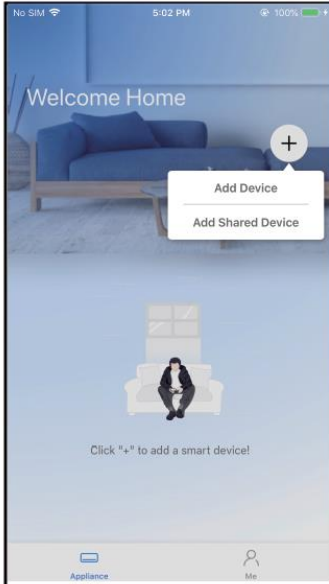

- ③ The other users must log in “Nethome Plus” app first, then click “Add Share Device” on their own mobile, then ask them to scan the QR code.



- ④ Now the others can add the shared device.

## App Declaration

The app may not support the latest software versions of Android and iOS systems. Not all Android and iOS systems are compatible with the app. We will not be responsible for any issue as a result of incompatibility.

The camera on the mobile device needs to be 5 million pixels or above to ensure the QR code can be scanned properly.

The app is subject to update without prior notice. The actual network configuration process may be slightly different from the manual. The actual process shall prevail.

**Water Drainage** – During dehumidifying modes, remove the drain plug from the back of the unit, install the drain connector. For models without a drain connector, just attach the drain hose to the hole. Place the open end of the hose directly over the drain area.



Remove the drain plug

Continuous drain hose

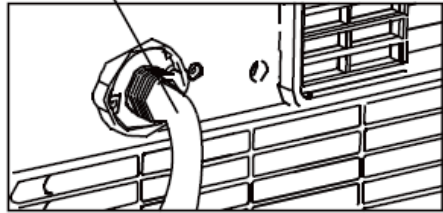

Note: Make sure the hose is secure so there are no leaks. Direct the hose toward the drain, making sure that there are no kinks that will stop the water flowing. Place the end of the hose into the drain and make sure the end of the hose is down to let the water flow smoothly. When the continuous drain hose is not used, ensure that the drain plug and knob are installed firmly to prevent leakage.

When the water level of the bottom tray reaches the predetermined level, the unit beeps 8 times and the LED DISPLAY will show 'P1'. At this time, the air conditioning/dehumidifying process will stop. The fan motor will continue to operate (this is normal). Carefully move the unit to a drain location, remove the bottom drain plug and let the water drain away. Reinstall the bottom drain plug and restart the machine until the 'P1' symbol disappears. If the error repeats, call our customer service team.

Note: Be sure to reinstall the bottom drain plug firmly to prevent leakage before using the unit.

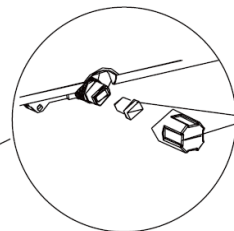
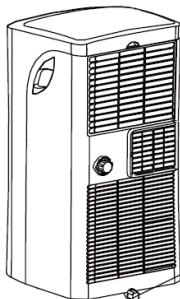

Bottom drain plug

## Cleaning, Maintenance and Storage

- Always unplug the unit before cleaning or servicing.
- DO NOT use flammable liquids or chemicals to clean the unit.
- DO NOT wash the unit under running water.
- DO NOT operate the machine if the power supply was damaged during cleaning. Contact customer service if this happens.

### Air Filter Cleaning

- DO NOT operate the unit without a filter because dirt and lint will clog it and reduce performance.
- Be sure to clean the air filter every 2 weeks for optimal performance.
- The water collection tray should be drained immediately after 'P1' error occurs and before storage to prevent mould.
- In households with animals, you will have to periodically wipe down the grill to prevent blocked airflow due to animal hair.

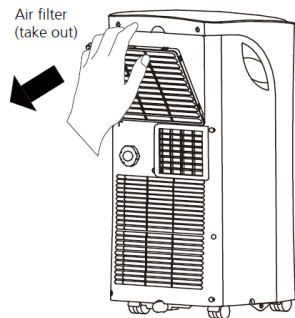

Remove the air filter

### Unit Cleaning

Clean the unit using a damp, lint-free cloth and mild detergent. Dry the unit with a dry, lint-free cloth.

### Storing The Unit When Not In Use

- Drain the water collection tray as instructed in the above section.
- Run the appliance on 'FAN' mode for 12 hours in a warm room to dry it and prevent mould. Then turn off the appliance and unplug it.
- Clean the air filter as instructed in the above section. Reinstall the clean, dry filter before storing.
- Remove the batteries from the remote control.

Note: Store the unit away from direct sunlight or extreme heat as this can shorten the lifespan of the unit.

## Troubleshooting

<b>Problem</b>	<b>Possible Causes</b>	<b>Solution</b>
Unit does not turn on when pressing ON/OFF button	P1 Protection Code	The Water Collection Tray is full. Turn off the unit, drain the water and restart the unit
	In 'COOL' mode: room temperature is lower than the set temperature.	Reset the temperature
	E0 EEPROM Error	Contact customer service
Unit does not cool well	The air filter is blocked with dust and animal hair	Turn off the unit and clean the filter
	Exhaust hose is not connected or blocked	Turn off the unit, disconnect the hose and check for blockages
	The unit is low on refrigerant	Contact customer service
	Temperature setting is too high	Decrease the set temperature
	The windows and doors in the room are open	Close all doors and windows.
	The room area is too large	Check the cooling area
	There are heat sources inside the room	Remove the heat sources if possible
The unit is noisy and vibrates too much	The ground is not level	Place the unit on a flat, level surface
	The air filter is blocked with dust or animal hair	Turn off the unit and clean the filter
The unit makes a gurgling sound	This sound is caused by the flow of refrigerant inside the unit	This is normal

## Spare Parts and Repairs

---

To order replacement parts, please go to [www.nettadirect.com/parts](http://www.nettadirect.com/parts).

You will need PDC information from your product, user manual or carton box. Alternatively, go to our website and use search bar to find the parts available.

You can also find this code on the [back of this User Manual](#).

For our Repair Service, please contact our customer support with email on [support@nettadirect.com](mailto:support@nettadirect.com) they will provide with more details of repair service with NETTA.

## Disposal of Product

---

**IMPORTANT INFORMATION FOR CORRECT DISPOSAL OF THE PRODUCT IN ACCORDANCE WITH EC DIRECTIVE 2002/96/EC.**

### **DISPOSAL:**

Please dispose of this product responsibly. This item cannot be disposed of with general waste. Please contact your local council authority for more information on how to dispose this product. If this product is disposed of with general waste, it will end up in a landfill and will leak hazardous substances into the groundwater – effecting our food chain.



## Your Warranty

---

If you purchased with NETTADIRECT, or one of our authorised resellers, you will automatically enrol your warranty for 1 (ONE) year. You do not need to register again for your warranty. All warranties will be carried out our terms and conditions including warranty conditions which you can find out from our website at [www.nettadirect.com](http://www.nettadirect.com).

## Copyrights

---

NETTA and its logo including images and contents in this manual and website is copyrighted. All intellectual property rights belong to NETTA owner CONSUMABLE DIRECT LIMITED.

ANY UNAUTHORISED USE, MODIFICATION or DISTRIBUTION of the NETTA logo, website image, and its contents (from website, manuals) will violate worldwide copyright, trademark and associated laws.

We reserve the right to proceed with lawsuits to anyone who is found breaching our copyrights policy. For more details, please check our website copyright policy for more information.

## Product Dependency Code (PDC)

---

Your PDC is below:

**PDC: MPPHA-08CRN7-QB6**  
**SKU: 103973**

NETTA is a registered trademark of CONSUMABLE DIRECT LIMITED.  
Product Produced for CONSUMABLE DIRECT LIMITED M30 0QF U.K.