

GLASS PANEL FIREPLACE



RATED POWER
1400-1600W

STYLE
WALL-MOUNTED
OR RECESSED

TIMER
WEEKLY

**REMOTE
CONTROL
INCLUDED**



Thank you for purchasing this NETTA product.

Please read the user manual carefully before operating this appliance.

We will update our instruction manuals if necessary.

For the most up-to-date user manual, please visit our official website: www.nettadirect.com.

You can download a copy of up-to-date user manuals at any time in electronic format. We do not supply you with a paper-based user manual after each revision.

**Require a larger version of this
Instruction Manual?**

**Please download electronically
from our website and use PDF
reader on your device to enlarge
the text if needed.**

www.nettadirect.com

Safety and Warnings

Intended Use

NETTA Design is for domestic and indoor use only. This product is not intended for use by people who have lack of experience and knowledge or have reduced ability, or sensory and mental capabilities.

Regular Check-Ups

Ensure the power cable and plug are not damaged before plugging into a socket.

Check all the buttons are functioning correctly.

General Warnings

- Read all instructions before using this heater.
- Ensure the plug is connected to the mains socket securely.
- This heater is hot when in use. To avoid burning yourself, do not touch the hot surfaces. Use the handles provided when moving this heater.
- Keep combustible materials such as furniture, pillows, bedding, papers, clothes and curtains at least 1m from the front of the heater and away from the sides and rear. In order to avoid overheating, do not cover the heater.
- Extreme caution is necessary when any heater is used near children and/or when the heater is left operating and unattended.
- Always unplug the heater when it is not in use.
- Do not operate any heater with a damaged cord or plug, after the heater malfunctions or after it has been dropped or damaged. In this case, contact your retailer for their replacement/repair service.
- This heater is for indoor use only. Do not use outdoors.
- This heater is not intended for bathrooms, laundry areas or similar indoor locations. Never locate the heater where it may come into contact with water/liquid.
- Do not run the cord under carpeting, rugs, or similar coverings.
- Place the cord away from busy areas where it may become a trip hazard.

General Warnings

- Do not insert or allow foreign objects to enter any ventilation or exhaust opening as this may cause an electric shock, fire or damage the heater.
- To prevent a potential fire, do not block the air intakes or exhausts in any manner. Do not use on soft surfaces, such as a bed, where openings may become blocked.
- The heater has hot and sparking parts inside. Do not use it in areas where gasoline, or similar flammable liquids, are used or stored.
- Use the heater only as described in this manual. Any other use not recommended by the manufacturer may cause fire, electric shock or injury as well as voiding your warranty.
- High temperatures may be generated under certain abnormal conditions. Do not partially or fully cover/obstruct the front of this heater.
- The replacement of the lamps should only be done when the heater is disconnected from the supply circuit.
- This appliance is not intended for use by persons (including children) with reduced physical, sensory or mental capabilities, or lack of experience and knowledge, unless they have been given supervision or instruction concerning use of the appliance by a person responsible for their safety.
- Children should be supervised to ensure that they do not play with the appliance.
- In order to avoid a hazard due to the inadvertent re-setting of the thermal cut-out, this appliance must not be supplied through an external switching device, such as a timer, or connected to a circuit that is regularly switched on and off by the utility.
- To disconnect the heater, turn the controls to off, then remove the plug from the socket.

When using electric appliances, basic precautions should always be followed to reduce the risk of fire, electric shock and injury to persons.

Assembling the Product













This product is constructed with a glass panel. Always use extreme caution when handling glass. Failure to do so could result in personal injury or property damage.

Remove all parts and hardware from the carton and place them on a clean, soft and dry surface. Parts and assembly steps are grouped for wall-hanging or recessing use. Check the parts list to make sure nothing is missing. If disposing of the packaging, please recycle where possible.

You will need the following tools (not included):

- Phillips Screwdriver
- Stud Finder
- Spirit Level
- Tape Measure
- Electric Drill
- 1/4" Wood Drill Bit
- Hammer

Parts and Hardware

 <p>A – Fireplace</p>				
		<p>B – Wood Screws</p>		<p>C – Drywall anchors</p>
				
		<p>Remote Control</p>		<p>D - Metal Bracket</p>
				
<p>E-Wall Bracket Fixed on back of firebox</p>	<p>F-Decorative Pebbles</p>	<p>G-Decorative Crystals</p>	<p>H - Log set</p>	<p>I - Plastic Tray</p>

Specification and Dimension

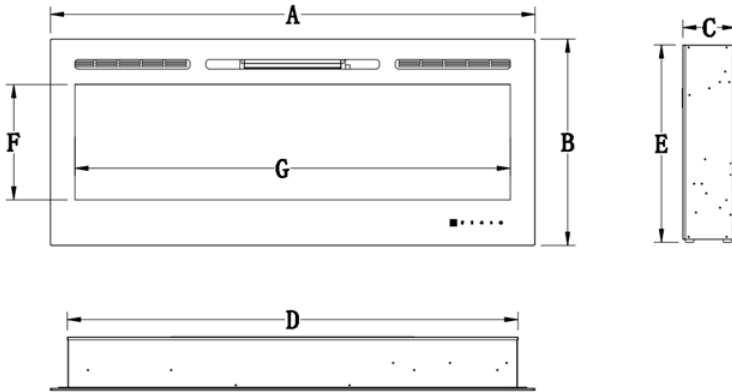

PRODUCT DIMENSIONS

Model Number	A	B	C	D	E	F	G
BG-40B	40"	21.46"	5.51"	32.48"	20.51"	12"	30.91"
	101.6cm	54.4cm	14cm	82.5cm	52.1cm	30.5cm	78.5cm
BG-50B	50"	21.46"	5.51"	46.85"	20.51"	12"	45.28"
	128cm	54.4cm	14cm	119cm	52.1cm	30.5cm	115cm
BG-60B	60"	21.46"	5.51"	46.85"	20.51"	12"	45.28"
	152.4cm	54.4cm	14cm	119cm	52.1cm	30.5cm	115cm

Your appliance is a wall-mounted/recessed/mantel installation. Select a suitable location to install it that is not susceptible to moisture and is away from drapes, furniture and high-traffic areas.

Note: Follow all national and local electrical codes.

MINIMUM CLEARANCE TO COMBUSTIBLES

Measurements are taken from the glass front.

Bottom	0"	Top	8" (300mm) to mantel
Sides	0"	Top	8" (300mm) to ceiling
Back	0"		

Recessed To Wall Installation

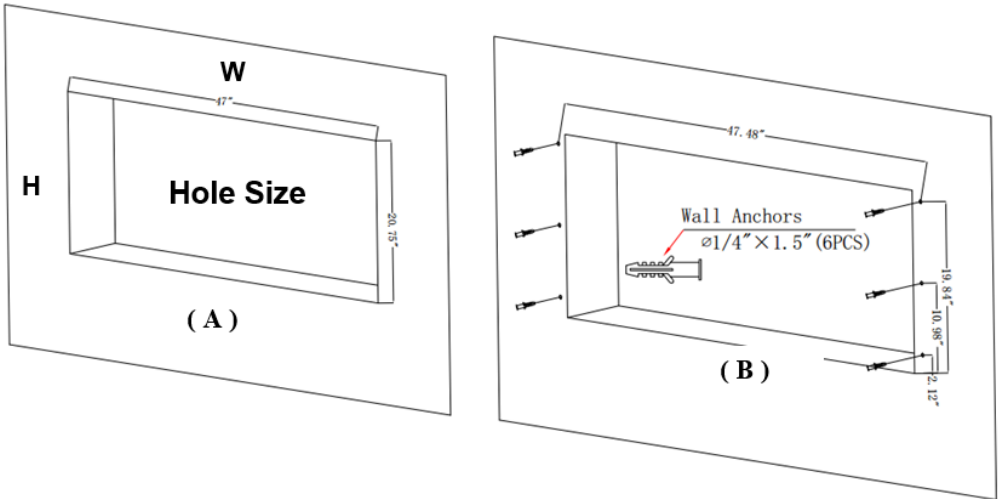

- A.** Select an area of dry wall to create a framing hole for the fireplace. The size of hole needed can be found on the chart below. **(Fig. A).**

Framing Hole Size		
Model Number	W	H
BG-40B	33" (83.82CM)	20.75" (52.71CM)
BG-50B	47" (119.38CM)	20.75" (52.71CM)
BG-60B	47" (119.38CM)	20.75" (52.71CM)

- B.** Fix the three wall anchors to each side of the fireplace according to the dimensions shown on the drawing. **(Fig. B).**
- C.** Remove the two screws in both sides of the glass panel. **(Fig. C (Next Page)).**

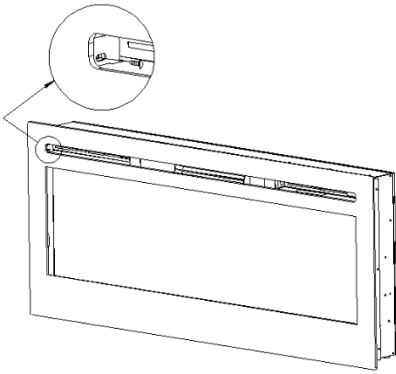

(C)

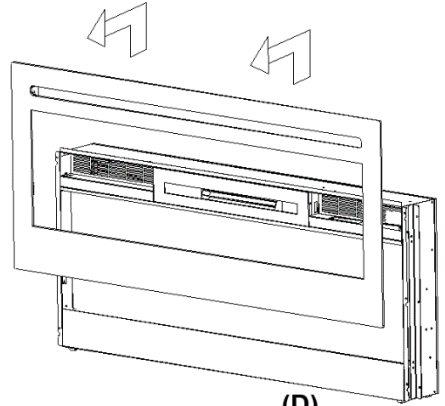

(D)

D. Have two people remove the glass panel from the front of the fireplace. Place it onto a soft and clean place. **(Fig. D).**

E. Have two people move the fireplace to the wall hole.

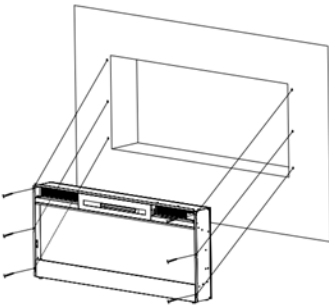

(E)

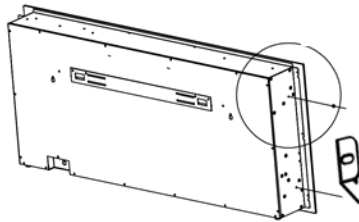

(F)

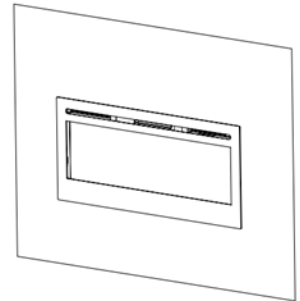

(G)

If the appliance is fully recessed into the wall:

- Use the 6 screws (provided) to lock the appliance into the wall with the existing two side flanges. **(Fig. E).**
- Re-install the glass panel when the fireplace is installed.

If the appliance is partially recessed into the wall:

- Use the four mounting metal brackets (provided) to lock the appliance to the wall. **(Fig. F).**
 - **Note:** Use the existing holes on the sides of the appliance for recessing into a wall.
- F. The fireplace should now look like this after installation. **(Fig. G).**

Wall-Mounted Installation

Due to the many different materials used on different walls, it is highly recommended that you consult your local builder before you install this appliance on the wall.

- A. Select a location that is not prone to moisture and is located at least 36" (91cm) away from combustible materials such as curtains, furniture or bedding.
- B. Have two people hold the appliance against the wall to determine the final location.

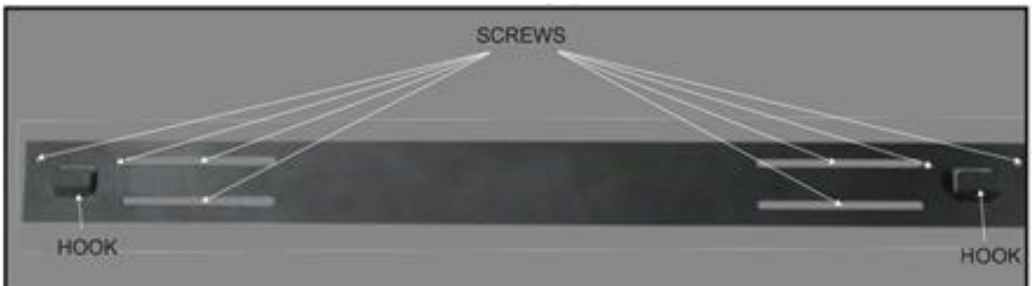

- C. Place the unit face down on a soft, non-abrasive surface. Remove the bracket from the back of the unit by removing the screws (See Fig. 1).
- D. Mark out the location, then mount the bracket(s) onto the wall using the supplied screws. This bracket **MUST** have the hooks facing upward and be level.

Note: It is strongly recommended that the mounting bracket (E) be screwed into the wall studs where possible. If the wall studs cannot be used, ensure that the supplied plastic anchors are used to affix the bracket to the wall and the bracket is adequately secured.

- E. With the wall-mounting bracket installed, have two people lift the appliance up and insert the two hooks on the bracket into the two slots on the back of the appliance.
- F. Check the appliance for stability ensuring that the bracket will not pull free from the wall.

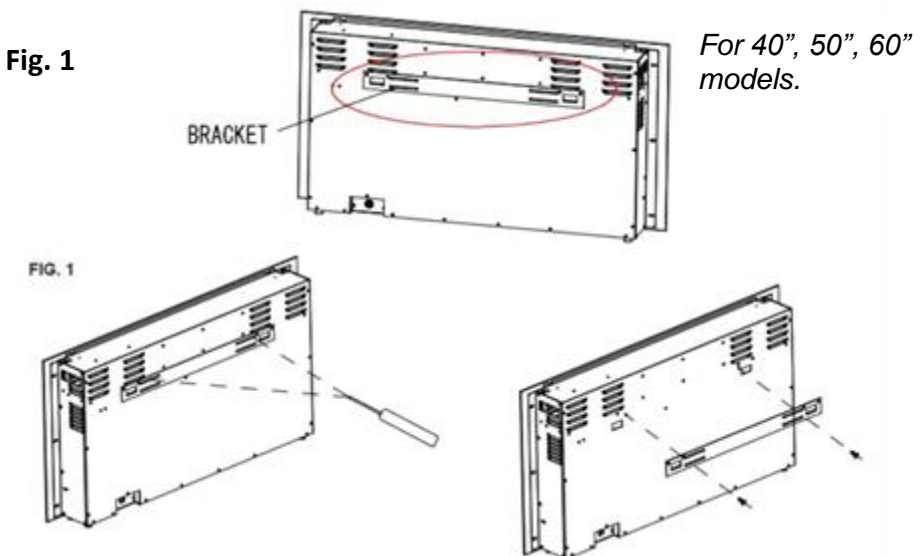

For 72" model.

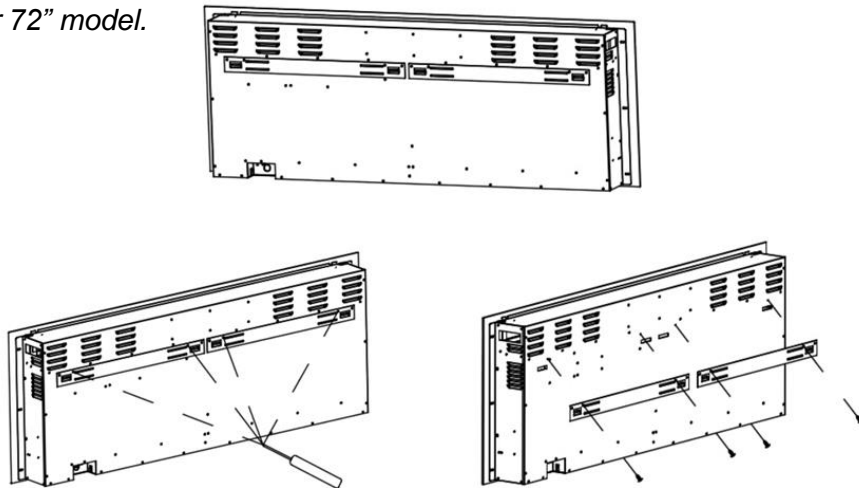

Log/Crystal/Pebble Ember Installation

- A. The appliance must be mounted in its final location with the front glass removed before installing the logs/crystal/pebble embers.
- B. To install the logs, remove the logs from its packaging and insert it into the fireplace (Fig. 1).
- C. To install the crystals or pebbles, place the plastic tray (Part - I (Parts and Hardware)) in the allotted space before carefully placing the crystal or pebble embers into the bottom tray at the front of the appliance as illustrated. Apply an even layer from side to side. (Fig 2 and 3).
- D. Crystal or pebble embers may have a fine oil residue that needs to be cleaned prior to installation. Clean them with a mild dish soap, rinse them thoroughly and allow to dry before placing into the tray.

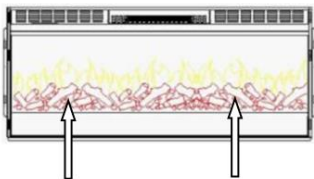

Figure 1.

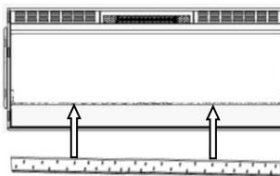

Figure 2.



Figure 3. (Crystals)

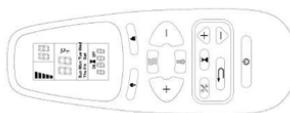

Figure 3. (Pebbles)

Operating the Product

This electric fireplace can be operated by the control panel, located on the bottom right-hand side of the glass panel, or by the battery-powered remote control. The operation and functions of the two methods are the same.

Before operating, please review the **General Warnings** at the beginning of this manual.





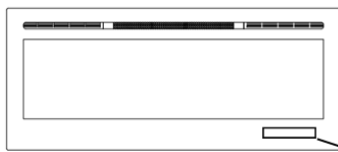



Remote Control







Touch Panel

Touch Control Panel Operation

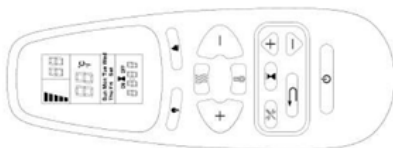





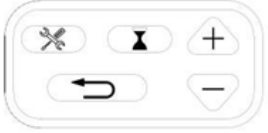

BUTTON	FUNCTION	ACTION & INDICATION
 POWER	ON: Enables control panel functions and remote control. Turns on flame effect. OFF: Disables control panel functions and remote control. Turns off flame effect.	<ol style="list-style-type: none"> Press once. Indicator light turns on. Power turns on. All functions enabled. Press again. Flame effect turns off. Power and all functions turn off.
 TIMER	TIMER button: Control's timer settings to turn off fireplace at selected time. Settings range from 0.5 hours to 8 hours.	<ol style="list-style-type: none"> Press once. Indicator light turns on. Timer is set to 0.5 hours. Press again until desired setting is reached. Display window shows setting.
 FLAME	FLAME button: Makes flame effect dimmer and brighter. NOTE: Flame effect stays on until power button is turned off. Flame effect must be on for heater to turn on.	<ol style="list-style-type: none"> Press once. Indicator light turns on. Flame brightness effect gets changing. Press again. until desired setting is reached.
 COLOR	COLOR button: Makes the color flame effect changing. NOTE: color effect stays on until power button is turned off. Color flame effect must be on for heater to turn on.	<ol style="list-style-type: none"> Press once. Indicator light turns on. Flame color effect gets changing. Press again until desired setting is reached. Display window shows setting.
 HEATER	HEATER button: Turns heater on and off. NOTE: The heater only works when the flame effect is on. If the flame effect is off, the heater will not turn on. NOTE: To prevent overheating, the heater blows cool air for 10 seconds before the heater turns on, and after it turns off.	<ol style="list-style-type: none"> Press once. Indicator lights up. Fan blows cool air for 10 seconds. Low heater turns on and blows warm air. Press again. Indicator lights up. High heater turns on and blows hot air. Press again. Heaters turn off. <i>The fan blows cool air, then turns off.</i>
 TEMP	TEMPERATURE button: Turns heater on and off. NOTE: Press & Hold the button for 5 seconds, the temperature setting will switch from °C to °F. Same way from °F to °C.	<ol style="list-style-type: none"> Press once: Indicator lights up. Temperature goes to 18 °C Press again: until desired setting is Reached.

Remote Control Operation





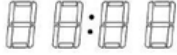





BUTTON	FUNCTION	ACTION & INDICATION
 POWER	ON: Enables control panel functions and remote control. Turns on flame effect. OFF: Disables control panel functions and remote control. Turns off flame effect.	<ol style="list-style-type: none"> Press once. Indicator light turns on. Power turns on. All functions enabled. Press again. Flame effect turns off. Power and all functions turn off.
	COLOR button: Makes the color flame effect changing. NOTE: color effect stays on until power button is turned off. Color flame effect must be on for heater to turn on.	<ol style="list-style-type: none"> Press once. Indicator light turns on. Flame color effect gets changing. Press again until desired setting is reached. Display window shows setting.
	FLAME button: Makes flame effect dimmer and brighter. NOTE: Flame effect stays on until power button is turned off. Flame effect must be on for heater to turn on.	<ol style="list-style-type: none"> Press once. Indicator light turns on. Flame brightness effect gets changing. Press again. until desired setting is reached.
 HEATER	HEATER button: Turns heater on and off. NOTE: The heater only works when the flame effect is on. If the flame effect is off, the heater will not turn on. NOTE: To prevent overheating, the heater blows cool air for 10 seconds before the heater turns on, and after it turns off.	<ol style="list-style-type: none"> Press once. Indicator lights up. Fan blows cool air for 10 seconds. Low heater turns on and blows warm air. Press again. Indicator lights up. High heater turns on and blows hot air. Press again. Heaters turn off. The fan blows cool air, then turns off.

Timer Settings on Remote Control

 : Timer: Displays current day, time, and week. Press to enter or confirm timer settings.																																																										
 : Settings: Press to move to next step (use with Timer button). Press to confirm week timer.																																																										
 : Back: Press to clear timer settings. Press to return to the previous step (use with Settings button).																																																										
 : Up and Down (use with Settings button).																																																										
LCD Screen																																																										
Weekday  Mon, Tues, Wed, Thurs, Fri, Sat, Sun	Sun Mon Tue Wed Thu Fri Sat	Note: The functions can only be adjusted when the related letters or digits are flashing.																																																								
Time Display  Current Time / Timer From 00: 00 to 24 NOTE: 00-12:00 is AM / 13:00-24:00 is PM	ON  OFF 	Note: Calibrate the timer to current time before the weekly settings.																																																								
 TEMP	TEMPERATURE button: Turns heater on and off. NOTE: Press & Hold the button for 5 seconds, the temperature setting will switch from °C to °F. Same way from °F to °C.	<ol style="list-style-type: none"> Press once: Indicator lights up. Temperature goes to 18 °C Press again: until desired setting is Reached. Digital display shows setting circles as below: <table border="1" data-bbox="169 983 1053 1102"> <thead> <tr> <th>NO</th> <th>0</th> <th>1</th> <th>2</th> <th>3</th> <th>4</th> <th>5</th> <th>6</th> <th>7</th> <th>8</th> <th>9</th> <th>10</th> <th>11</th> <th>12</th> </tr> </thead> <tbody> <tr> <td>°C</td> <td>18</td> <td>19</td> <td>20</td> <td>21</td> <td>22</td> <td>23</td> <td>24</td> <td>25</td> <td>26</td> <td>27</td> <td>28</td> <td>29</td> <td>30</td> </tr> <tr> <td>°F</td> <td>64</td> <td>66</td> <td>68</td> <td>70</td> <td>72</td> <td>74</td> <td>76</td> <td>78</td> <td>80</td> <td>82</td> <td>84</td> <td>86</td> <td>88</td> </tr> <tr> <td></td> <td>65</td> <td>67</td> <td>69</td> <td>71</td> <td>73</td> <td>75</td> <td>77</td> <td>79</td> <td>81</td> <td>83</td> <td>85</td> <td>87</td> <td></td> </tr> </tbody> </table>	NO	0	1	2	3	4	5	6	7	8	9	10	11	12	°C	18	19	20	21	22	23	24	25	26	27	28	29	30	°F	64	66	68	70	72	74	76	78	80	82	84	86	88		65	67	69	71	73	75	77	79	81	83	85	87	
NO	0	1	2	3	4	5	6	7	8	9	10	11	12																																													
°C	18	19	20	21	22	23	24	25	26	27	28	29	30																																													
°F	64	66	68	70	72	74	76	78	80	82	84	86	88																																													
	65	67	69	71	73	75	77	79	81	83	85	87																																														





Set Current Day and Time

- Press  once. When “MON” (Monday) begins flashing, use  to select the current day.
- Press . When the hour digits begin flashing, use  to select the current hour.













3. Press  again. When the minute digits begin flashing, use   to select the current minute.
4. Press  again. The current time is now set.



Set ON/OFF Time and Temperature on a 7-Day Weekly Cycle

Ensure the fireplace is switched on before starting this process.

1. Press . When “MON” begins flashing, press  3 times. When “ON” begins flashing, use   to select the desired hour and minute for the heater to turn on.



Note: The timer can only be adjusted in 30-minute increments (i.e., 00:00-00:30; 00:30-01:00, etc).

2. Press . When “OFF” begins flashing, use   to select the desired hour and minute for the heater to turn off.
3. Press  again. When “18” begins flashing, use   to set the desired temperature for Monday. Note: If a temperature was previously set, those digits will be displayed instead of “18”.
4. Press  again. When “TUE” appears on the screen and “ON” begins flashing, use   to select the desired hour and minute for the heater to turn on every Tuesday.
5. Press  again. When “OFF” begins flashing, use   to select the desired hour and minute for the heater to turn off every Tuesday.

6. Press  again. When “18” begins flashing, use  to select the desired temperature for Tuesday.
7. Repeat steps 4 to 6 to set the “ON/OFF” time and temperature for the remaining days.
8. **Make sure the fireplace is on (if it’s not already) and press  to complete the programming, ensuring you aim the remote control at the receiver, located in the middle of the appliance. The appliance will “beep” once to confirm that the programming has been successful.**
9. **Please note that the heater will need to be switched on before you can complete the programming. If the heater is off, you will not hear a beep and the timer will not be set.**

Set ON/OFF Time and Temperature for a Specific Day(s)

Ensure the fireplace is switched on before starting this process.

1. If you wish to set the timer for a specific day(s), press  and then press  for as many times needed before you reach the required day. Follow steps 1, 2 and 3 to set the timer and the temperature.
2. Ensure the fireplace is turned on (if it’s not already) and press  to set the programming. The appliance will “beep” once to confirm that the programming has been successful. Once set, you can turn the fireplace off.

Press  at any time to clear the digits and turn the timer settings off.

Open Window Warning

If the room temperature decreases by 10 degrees within 3 minutes, the appliance will assume there is an open window nearby. In order to conserve energy, the heater will automatically switch from High Heat to Low Heat, or if the heater is already set to Low Heat, it will turn off completely.

When switching from High Heat to Low Heat, the appliance will beep 3 times and the digital display will flash “88” 3 times before displaying the existing heating status.

When switching from Low Heat to Off, the appliance will beep 3 times and the digital display will flash “88” continuously.

To reset the heating function, see the “Remote Control Operation” section.

Note: When the heater is first turned on, a slight odour may be present. This is normal and should not occur again unless the heater is not used for a long period of time.

Note: To improve operation, aim the remote control at the front of the fireplace. Do not press the buttons too quickly. Give the unit time to respond to each command.

Temperature Limiting Control

This heater is equipped with a temperature limiting control. Should the heater reach an unsafe temperature, the heater will automatically turn off. To reset:

1. Unplug the power cord from the socket.
2. Turn the On/Off switch on the control panel to off and wait 5 minutes.
3. Inspect the fireplace to make sure no vents are blocked or clogged with dust. If they are, use a vacuum to clean the vents.
4. With the power switch in the Off position, plug the power cord back into the socket.
5. If the problem continues, have your sockets and wiring inspected by a professional.

Remote Control Battery Information

This remote control uses 2 AAA batteries (not included).

Always dispose of batteries in a safe way. Contact your council or local recycling centre for more information on battery disposal.

Cleaning, Maintenance and Storage

- Always turn the heater OFF and unplug the power cord from the socket before cleaning, performing maintenance, or moving this fireplace. Failure to do so could result in electric shock, fire, or personal injury.
- Never immerse in water or spray with water. Doing so could result in electric shock, fire, or personal injury.

Metal:

- Buff using a soft cloth, slightly dampened with a citrus oil-based product.
- Do not use brass polish or household cleaners as these products will damage the metal trim.

Glass:

- Use a good quality glass cleaner sprayed onto a cloth or towel. Dry the glass panel with a paper towel or lint-free cloth.
- Never use abrasive cleaners, liquid sprays, or any cleaner that could scratch the surface.

Vents:

- Use a vacuum or duster to remove dust and dirt from the heater and vent areas.

Plastic:

- Wipe gently with a slightly damp cloth and a mild solution of dish soap and warm water.
- Never use abrasive cleaners, liquid sprays, or any cleaner that could scratch the surface.



Risk of electric shock! Do not open any panels! There are no user-serviceable parts inside of the appliance.

- The fan motors are lubricated at the factory and do not require further lubrication.
- Electrical components are integrated in the fireplace and are not serviceable by the consumer.
- Store the heater in a clean, dry place when not in use.

Spare Parts and Repairs

To order replacement parts, please go to www.nettadirect.com/parts.

You will need PDC information from your product, user manual or carton box. Alternatively, go to our website and use search bar to find the parts available.

You can also find this code on the [back of this User Manual](#).

For our Repair Service, please contact our customer support with email on support@nettadirect.com they will provide with more details of repair service with NETTA.

Disposal of Product

IMPORTANT INFORMATION FOR CORRECT DISPOSAL OF THE PRODUCT IN ACCORDANCE WITH EC DIRECTIVE 2002/96/EC.

DISPOSAL:

Please dispose of this product responsibly. This item cannot be disposed of with general waste. Please contact your local council authority for more information on how to dispose this product. If this product is disposed of with general waste, it will end up in a landfill and will leak hazardous substances into the groundwater – effecting our food chain.



Your Warranty

If you purchased with NETTADIRECT, or one of our authorised resellers, you will automatically enrol your warranty for 1 (ONE) year. You do not need to register again for your warranty. All warranties will be carried out to our terms and conditions including warranty conditions which you can find out from our website at www.nettadirect.com.

Copyrights

NETTA and its logo including images and contents in this manual and website is copyrighted. All intellectual property rights belong to NETTA owner CONSUMABLE DIRECT LIMITED.

ANY UNAUTHORISED USE, MODIFICATION or DISTRIBUTION of the NETTA logo, website image, and its contents (from website, manuals) will violate worldwide copyright, trademark and associated laws.

We reserve the right to proceed with lawsuits to anyone who is found breaching our copyrights policy. For more details, please check our website copyright policy for more information.

Product Dependency Code (PDC)

Your PDC is below:

PDC: BG-40B / BG-50B / BG-60B
SKU: 103953 / 103954 / 103955

NETTA is a registered trademark of CONSUMABLE DIRECT LIMITED.
Product Produced for CONSUMABLE DIRECT LIMITED M30 0QF U.K.