



Pottery & Heat-Treating Electric Kilns Operating Manual



Building the Finest Kilns for Your Creative Spirit!

www.greatkilns.com

Division of Haugen Mfg.

P. O. Box 1347, 4225 Thurmon Tanner Parkway • Flowery Branch, GA 30542
Sales (800) 241-4400 • Help Line (770) 967-4009 • Fax (770) 967-1196 • Email info@greatkilns.com

REGISTER WARRANTY ONLINE

www.greatkilns.com

Go to Resources Tab and click on
Warranty Registration

CORRECTIONS of ERRORS and OMISSIONS

We have made every effort to ensure the accuracy of the information provided in this manual; however, we reserve the right to correct any errors and/or omissions found in this manual.

Pottery & Heat-Treating Electric Kilns Operating Manual

CONTENTS	Page Number
Model & Serial Number Identification	3
Electric Kiln Model Abbreviations.....	4
Locating Your Kiln.....	4
Electrical Requirements	5
Electrical Specifications for Olympic Electric Kilns	6
Assembly & Preparation of Your Kiln	8
Olympic Stackable Kilns Assembly.....	9
Kilns with Lid Lift Assist Assembly	10
Olympic Large Capacity Electric Kilns	15
Olympic Electric Car Kiln Installation Instructions	16
Electric Kilns – Other Components	22
Electronic Controller Operating Overview	24
Bartlett Genesis Controller.....	24
Bartlett V6-CF Controller	25
Bartlett RTC-1000 Controller	28
Error Codes for V6-CF, RTC-1000 & Genesis Controllers.....	30
Bartlett 3 Key-Cone Fire Controller	35
Error Codes	37
Electro Sitter.....	38
Electronic Wall Unit.....	39
3 Zone Control.....	39
Dual Media	39
Electric Raku Kilns.....	40
Loading Kiln for Pottery and Ceramics	42
Kiln Firing.....	44
Kiln Maintenance	46
Replacing Parts.....	47
Kiln Troubleshooting.....	56
Orton Pyrometric Cone Charts.....	58
Warranty	60

Electric Kiln Operator's Manual

Congratulations on your purchase of an Olympic Kiln! You have every reason to be proud and to feel you have the very best kiln. Your kiln, with the proper care, will provide you many years of dependable firings. Enjoy and Happy Firings!

Firing your ware is an art, not a science. You may need several tests and trials to perfect your firings. This book will give you suggestions on how to fire your kiln, but ultimately you will have your own unique firing method.

If you have any additional questions that are not covered in the manual, please contact your distributor or us either by phone (770) 967-4009, e-mail (info@greatkilns.com) or fax (770) 967-1196 and provide **the kiln model number and serial number** located on the silver tag on the kiln.



Building the Finest Kilns for Your Creative Spirit!

Model & Serial Number (SN) Identification

How to determine Kiln Model and Serial Number (SN):

The serial tag is silver in color with black writing and is usually located on the back or side of the first electrical box.



Model Designation

Olympic Kiln models signify their interior dimensions or cubic feet on most kilns and letters are abbreviations of how the kiln is built and equipped.

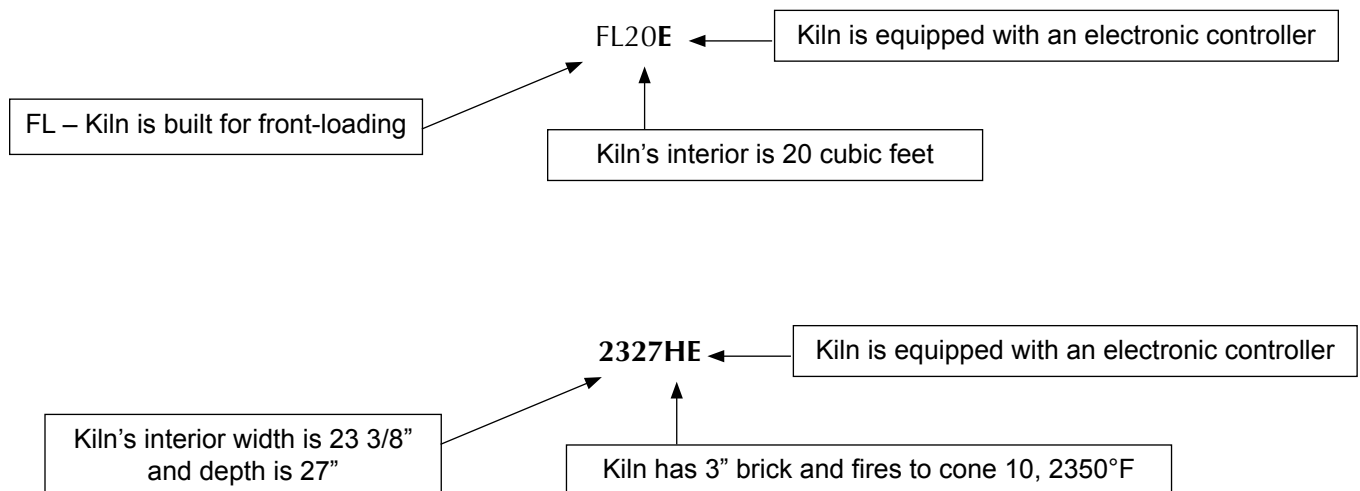

Electric Kiln Model Abbreviations

Bell –	Kiln chambers lift up with an electronic device
CAR –	Large capacity kiln built with a removable door and floor
CS –	Clamshell loading
CUBE –	Kiln is cubed design
DM –	Dual media for firing glass (lid element for fusing) and ceramics and rated to 2350°F – cone 10
E –	Equipped with an electronic digital controller
FL –	Front loading
H –	High-fire studio kilns built with 3" brick rated to 2350°F – cone 10 (large capacity electric kilns are all rated to cone 10 – 2350°F)
HB –	HotBox 120 volt small high fire models
S –	Studio solid stainless steel jacket kiln (the kiln is not stackable)
T –	Kiln is equipped with a kiln sitter and timer
TL –	Top loading large capacity electric kiln
TopHat –	Electric raku designed kiln with a lid element for glass fusing and rated to 2350°F – cone 10 for high fire ceramics

Locating Your Kiln

1. Adequate space – at least 12 inches of space between the kiln and the wall. (However, for operator comfort, allow room to walk around the kiln if maintenance is required.)
2. All flammable materials such as curtains, plastics, etc. in the area of the kiln should be removed.
3. Choose a dry, well-ventilated area with good access to allow easy loading and unloading, yet out of the way of children and other activities.
4. Position the kiln with the observation holes clearly visible and with the electronic controller within easy reach.
5. For kilns equipped with a power cord, place the kiln so that the cord can be plugged in without touching the metal jacket.
6. Because all kilns generate heat the stand or frame should be placed on a concrete or non-combustible floor.
7. If the kiln is to be placed outside make sure it doesn't get wet.
8. Remember to use sheet metal or non-flammable material to shim the legs when leveling the kiln.
9. Before your first firing vacuum the inside of the kiln to remove any dust caused by shipping.

Electrical Requirements

ELECTRICAL HOOK-UP

To provide the performance it was designed to give, your new kiln must have the proper outlet and breaker to supply adequate voltage and amperage. An incorrect connection may cause disappointing or even hazardous results. A qualified electrician needs to be consulted to determine whether your wiring is adequate.

Electric kilns running on 120 volts will plug into a standard outlet if they have a NEMA 5-15 power cord, but require a NEMA 5-20 receptacle if the power cord is 5-20.

Studio electric kilns will run on 240 or 208 volts, single phase. If your kiln was ordered three-phase power, it will be noted on the nameplate on the kiln.

Large capacity electric kilns may be wired for 208, 240, 380, or 480 volts; single or three phase.

Any kiln ordered three-phase will be direct wired.

RECEPTACLE, 2 POLE-3 WIRE GROUNDING NEMA CONFIGURATION

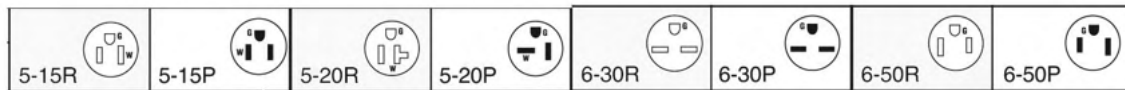

R = Receptacle Configuration P = Plug Configuration

Electrical Specifications for Olympic Electric Kilns – National Electrical Code requires breaker size to be 125% of load. Electrical specifications are recommendations only. Please consult with your local power company or electrician before installation.

Electrical Specifications for Olympic Electric Kilns

Volts	Amps	Watts	Breaker	Copper Wire Size	Plug Configuration
120	15	1,800	20	#12, #10 if circuit is longer than 40 ft.	NEMA 5-15
120	16	1,920	20	#12, #10 if circuit is longer than 40 ft.	NEMA 5-20

Volts	Amps	Watts	Breaker – 240/208 volt 1 Phase	Copper Wire Size	Plug Configuration
240/208	13/15	3,120	20	#12, #10 if circuit is longer than 40 ft.	NEMA 6-30
240/208	15/17	3,600	20/30	#12, #10 if circuit is longer than 40 ft.	NEMA 6-30
240/208	20/23	4,800	30	#10, #8 if circuit is longer than 40 ft.	NEMA 6-30
240/208	21/24	5,040	30	#10, #8 if circuit is longer than 40 ft.	NEMA 6-30
240/208	26/28-30	6,240	40	#8, #6 if circuit is longer than 40 ft.	NEMA 6-50
240/208	26.25/30	6,300	40	#8, #6 if circuit is longer than 40 ft.	NEMA 6-50
240/208	29/32	6,960	40	#8, #6 if circuit is longer than 40 ft.	NEMA 6-50
240/208	31/36	7,560	40/50	#8, #6 if circuit is longer than 40 ft.	NEMA 6-50
240/208	34/38	8,160	40/50	#8, #6 if circuit is longer than 40 ft.	NEMA 6-50
240/208	34-35/40	8,400	50	#6, #4 if circuit is longer than 40 ft.	NEMA 6-50
240/208	36/41	8,600	50	#6, #4 if circuit is longer than 40 ft.	NEMA 6-50
240/208	38/42	9,120	50/60	#6, #4 if circuit is longer than 40 ft.	NEMA 6-50
240/208	39/43	9,360	50/60	#6, #4 if circuit is longer than 40 ft.	NEMA 6-50
240/208	40/46	9,600	50/60	#6, #4 if circuit is longer than 40 ft.	NEMA 6-50
240/208	41/47	9,840	60	#6, #4 if circuit is longer than 40 ft.	NEMA 6-50
240/208	42/48	10,080	60	#6, #4 if circuit is longer than 40 ft.	NEMA 6-50

Electrical Specifications for Olympic Electric Kilns

Volts	Amps	Watts	Breaker Required 240/208 volts	Copper Wire Size	Receptacle, 2 Pole-3 Wire NEMA Configuration 240/208
240/208	45/50	10,800	60/70	#6, #4 if circuit is longer than 40 ft.	NEMA 6-50 – Direct Wired
240/208	47/48	11,280/ 9984	60	#6, #4 if circuit is longer than 40 ft.	NEMA 6-50
240/208	47-48/ 49-55.5	11,520	60/70	#6, #4 if circuit is longer than 40 ft.	NEMA 6-50 – Direct Wired
240/208	54/62	13,080	70/80	#4, #2 if circuit is longer than 40 ft.	Direct Wired
240/208	55/56	13,200	70	#4, #2 if circuit is longer than 40 ft.	Direct Wired
240/208	55/63	13,200	70/80	#4, #2 if circuit is longer than 40 ft.	Direct Wired
240/208	56/63-65	13,440	70/80	#4, #2 if circuit is longer than 40 ft.	Direct Wired
240/208	64/72-73	15,360	80/100	#4, #2 if circuit is longer than 40 ft.	Direct Wired
240/208	65/75	15,600	80/100	#4, #2 if circuit is longer than 40 ft.	Direct Wired
240/208	67/71	16,080	90/100	#4, #2 if circuit is longer than 40 ft.	Direct Wired
240/208	70/80-81	16,800	90/100	#4, #2 if circuit is longer than 40 ft.	Direct Wired
240/208	78/88	18,720	100/120	#4, #2 if circuit is longer than 40 ft.	Direct Wired
240/208	80/92-93	19,200	100/120	#4, #2 if circuit is longer than 40 ft.	Direct Wired
240/208	85/98	20,400	100/130	#4, #2 if circuit is longer than 40 ft.	Direct Wired
240/208	90/104	21,600	120	#4, #2 if circuit is longer than 40 ft.	Direct Wired
240/208	100/115	24,000	150	#4, #2 if circuit is longer than 40 ft.	Direct Wired
240/208	125/144	30,000	200	#4, #2 if circuit is longer than 40 ft.	Direct Wired
240/208	140/162	33,600	200	#2, #1 if circuit is longer than 40 ft.	Direct Wired
240/208	150/173	36,000	200	#1, #1/0 if circuit is longer than 40 ft.	Direct Wired
240/208	160/184	38,400	200	#1, #1/0 if circuit is longer than 40 ft.	Direct Wired
240/208	175/202	42,000	200/250	#1/0, #2/0 if circuit is longer than 40 ft.	Direct Wired

Assembly & Preparation of Your Kiln

If you purchase an *Olympic 120-volt, studio Front Loader, Electric Raku, Solid Jacket, or Large Capacity* electric kiln, your kiln is ready to fire upon arrival. After the kiln is unpacked or removed from the pallet, place kiln directly on stand; or in the case of a kiln with attached frame, place the kiln where it is to be located, plug-in and fire away.

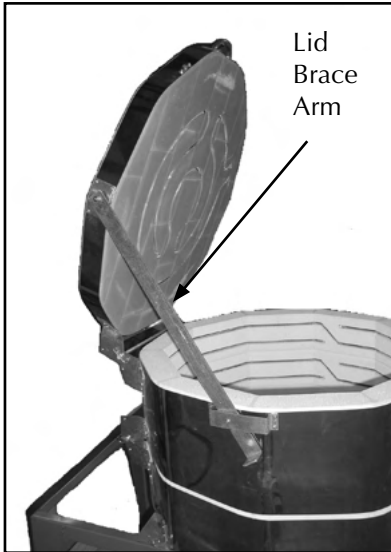

If the lid brace of your kiln was disconnected for shipping, it should be reconnected. Slide arm through brace pads and secure with nut. When opening the lid, insure the lid brace is locked by hooking it to the body brace pad. Do not release kiln lid until the brace is locked.

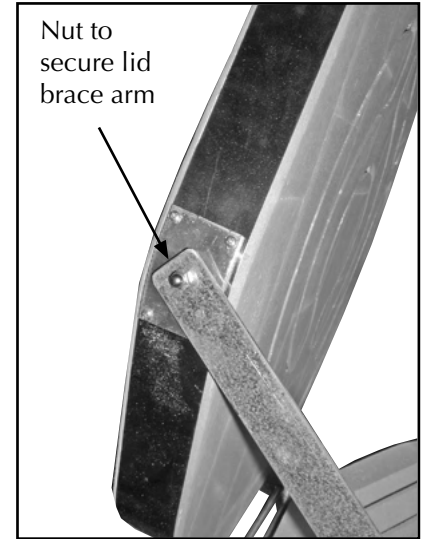

Body Brace Pad

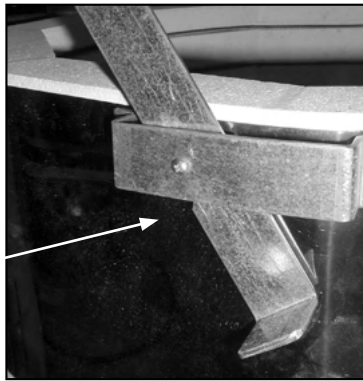

Your new kiln is constructed of insulating firebrick which is hand selected for the highest quality. This light weight brick is an efficient insulator, which forms the firing chamber. In Olympic's studio line of electric kilns the bricks are held together by compression of the stainless steel jacket. The wall bricks are not cemented together to facilitate maintenance of your kiln if necessary.

Top and Bottom Slabs

The top of every standard kiln is coated with a thin high temperature coating. This makes the lid more durable and prevents dusting of the brick particles on the pieces in the firing chamber.

The brick for the standard and commercial line of electric kilns is fragile and should always be handled with care. After a few firings, you may notice hairline cracks in the brick. These are simply expansion cracks and do not harm the functioning of the kiln.

Kilns built in rings and those with counter weight lid systems must be disassembled from the shipping pallet then reassembled on the stand. The proper method is to remove the top ring and place the bottom of the top ring flat on the floor. Repeat for each section until you reach the bottom of the kiln. Place the bottom on the kiln stand with the hose clamps to the back. At this time the stand can be leveled. If shims are required to make the bottom level, or prevent rocking of the bottom on the stand, use only sheet metal under the legs of the stand. Now reassemble the kiln with the observation holes to the front and electrical boxes aligned. Grasp the rings by the outside surface, and not the firebrick, to avoid damaging the kiln.

Olympic Stackable Kilns Assembly

Once the steps have been completed, the kiln will come apart in sections by lifting each ring straight up.

STEP 1.

Use a Phillips screwdriver to unscrew screws on the ring lock on the top ring of kiln. There are two ring locks per ring.

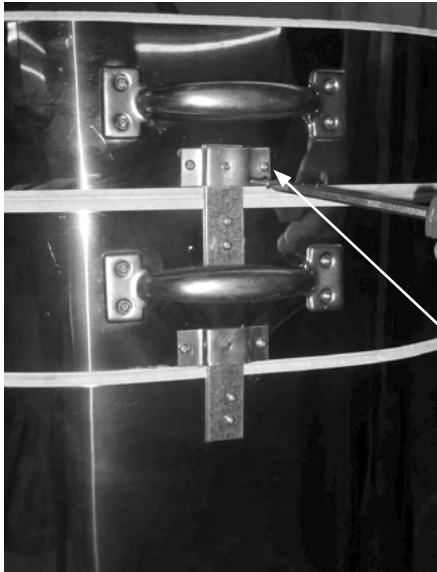

STEP 2.

Undo interbox plugs from receptacle of electrical boxes. Twisting and unlocking the plugs achieve this.

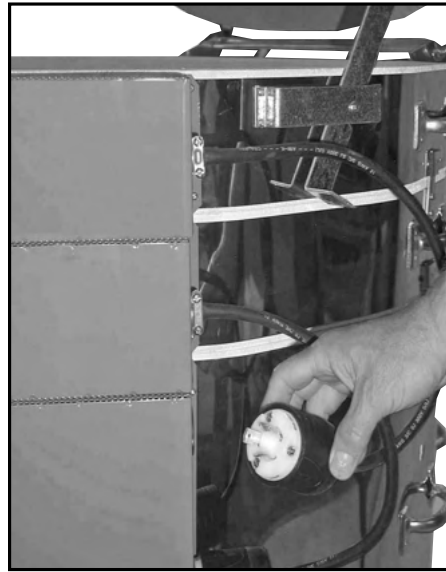

If the lid brace of your kiln was disconnected for shipping, it should be reconnected. Slide arm through brace pads and secure with nut. When opening the lid, insure the lid brace is locked by hooking it to the body brace pad. Do not release kiln lid until the brace is locked.

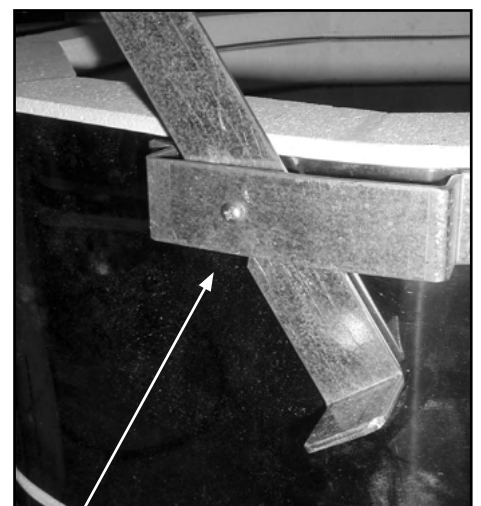
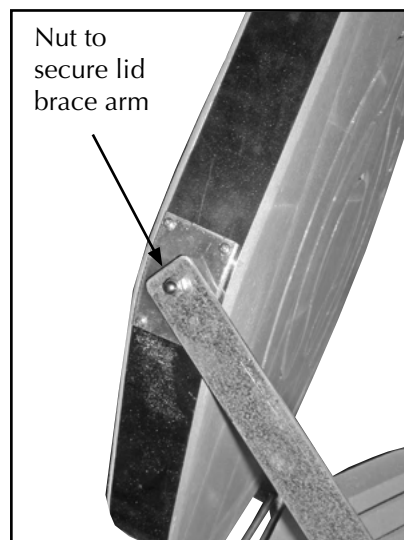

Body Brace Pad

Kilns with Lid Lift Assist Assembly



Double Bar



Single Bar

The lid lift assist comes complete with frame pieces for easy, simple installation or removal if there is a need to move the kiln from one location to another. There are two types, 1) double bar for ovals and square GF 2, 3, 5 series kilns; and 2) single bar for all other models. Glass fusing lid lift assist frames are designed with a tall 18" stand. **For kilns ordered with a vent, the vent cup will need to be placed before setting the kiln on top of the frame.**

Double Bar Lid Lift Assist



Attach feet onto legs of stand if the stand came with feet.

Kilns with Lid Lift Assist Assembly

Double Bar Lid Lift Assist

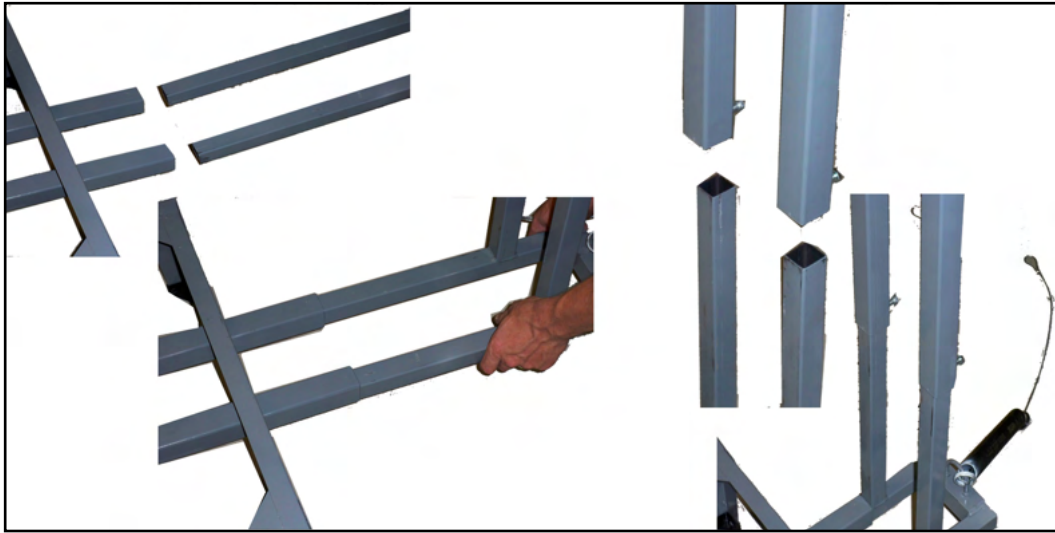

Insert horizontal back support frame to frame pieces on stand.

Insert vertical back support frame until pieces lock in place.



Position kiln floor and rings on stand with hose clamps on the stainless steel jacket facing the back supports. If your kiln is stackable, plug in twist 'n lock interbox plus and receptacles.

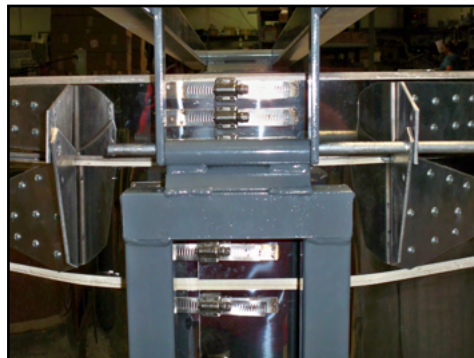
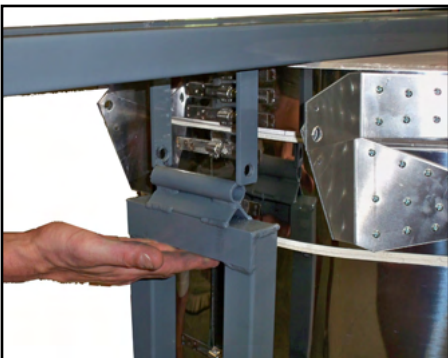

Position armlifter holes to match back of vertical back support holes and holes of lid. Insert stiffening strut through holes and lock in place with cotter pin.

Kilns with Lid Lift Assist Assembly

Double Bar Lid Lift Assist

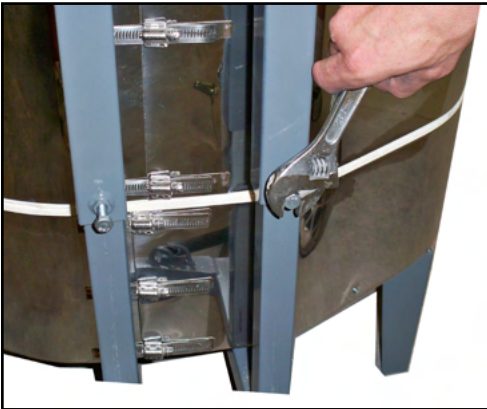

Tighten bolts on back of frame of lid opener. Lift kiln lid straight up and attach ring lock to arm lifter. Slowly lower lid to closed position.



When lid lifter is attached in back, insert bolt into front of bar and screw nut to hold.



Attach lid brace with nut and bolt. Screw locks in place if the kiln is stackable.

Kilns with Lid Lift Assist Assembly

Single Bar Lid Lift Assist

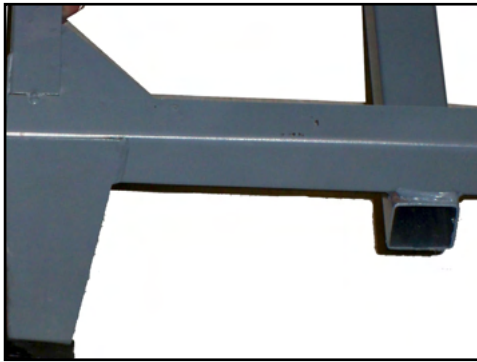

Attach feet onto legs of stand if the stand came with feet.



Insert horizontal and vertical back supports to frame until pieces lock in place.

Position kiln floor and rings on stand with hose clamps on the stainless steel jacket facing the back supports.



For stackable or sectional kilns, plug in twist 'n lock interbox plugs and receptacles.

Kilns with Lid Lift Assist Assembly

Single Bar Lid Lift Assist

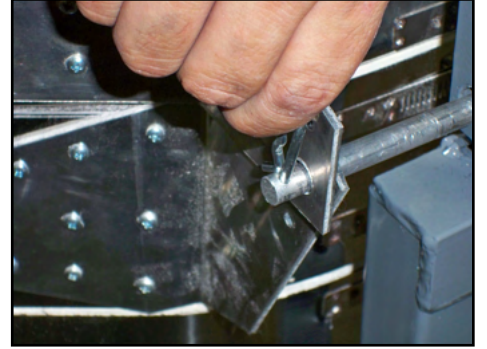
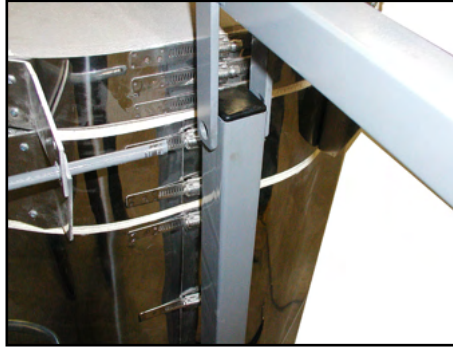

Position armlifter holes to match back of vertical back support holes and holes of lid hinge. Insert stiffening strut through holes and lock in place with cotter pin.



Tighten bolts on back of frame of lid opener.

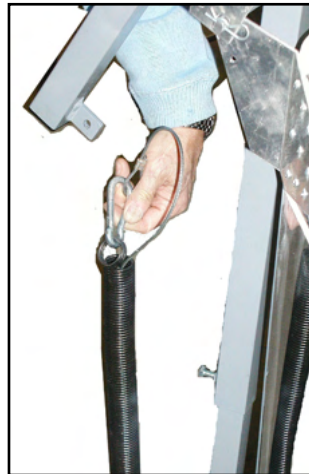

Lift kiln lid straight up and attach ring lock to armlifter. Slowly lower lid to closed position.



When lid lifter is attached in back, insert bolt into front of bar and screw nut to hold.



Attach lid brace with nut and bolt. Screw ring locks in place if kiln is stackable.

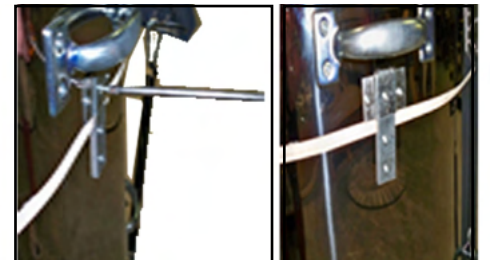

Olympic Large Capacity Electric Kilns



Olympic Large Capacity models 20 cubic feet or greater require the receiver to have a forklift to remove the kiln from the freight truck. These models are too large to be lowered on a lift gate. Fork extensions may need to be added to the forklift to unload freight from truck.

When you have removed the crating and the plywood packing from your freight you will see the Large Capacity electric kiln completely assembled and bolted to the shipping pallet. Olympic Front Loading and Top Loading Large Capacity models can be unbolted from the pallet, set in their location and ready to fire. The Large Capacity Car kilns require disassembly and reassembly prior to firing.

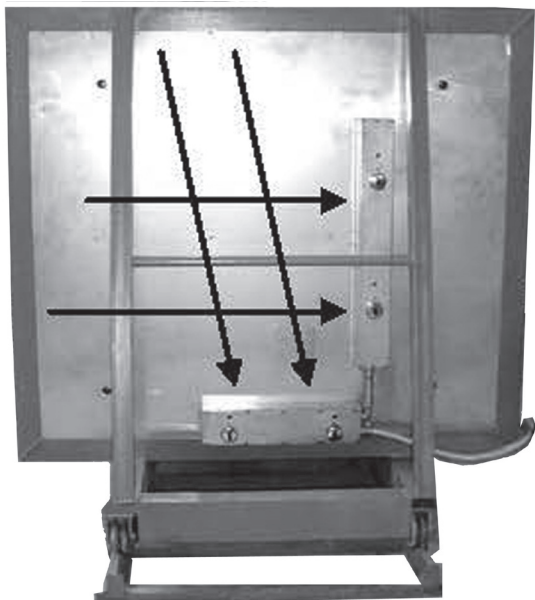

Infinite Switches

Large capacity electric kilns which are equipped with floor and door elements have infinite switches which control the heat intensity of the elements in the floor; and the left and right side of the door. Some models have infinite switches to control the heat intensity of the wall elements as well.



Olympic Electric Car Kiln Installation Instructions



Follow these instructions to avoid damage to your new car kiln as you unpack and setup.

STEP 1

Block wood pieces strapped to the pallet beside the kiln and the track strapped to the opposite side. Remove these from the pallet and install track with blocks and bolts provided.



Place the wood under the track and bolt the track to the kiln with the kiln on the pallet. Insure that the track is both level and straight.



Extreme damage to the kiln will result if the car is not level when removed from the firing chamber.

Olympic Electric Car Kiln Installation Instructions



Insure that the track is both level and straight.



Olympic Electric Car Kiln Installation Instructions

STEP 2

Unlatch the door and unplug the electrical connection from the door to the body of the kiln.

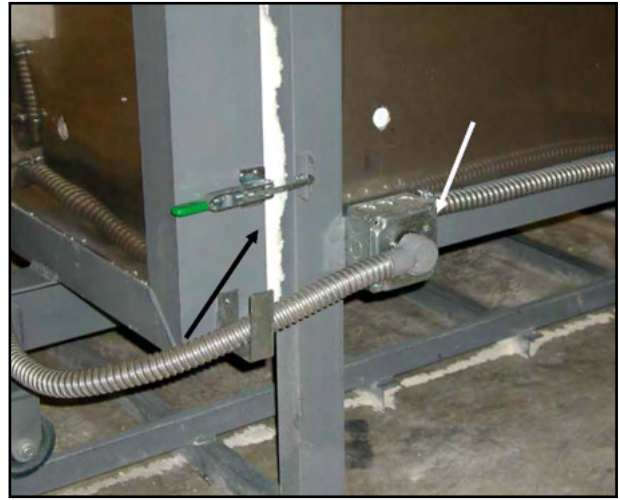

STEP 3

Carefully withdraw the door and car from the kiln, lift it over the ends of the rail onto the floor.



Olympic Electric Car Kiln Installation Instructions

STEP 4

Detach the rail from the kiln.



STEP 5

The bolts securing the kiln to the pallet must be removed.



STEP 6

The kiln may now be lifted from the pallet.



Olympic Electric Car Kiln Installation Instructions

STEP 7

When the kiln is in its permanent place, the track needs to be reinstalled and bolted to the kiln.



STEP 8

Position the car at the end of the rails. First, lift the front of the car onto the track, and then lift the back of the car onto the track. Carefully close the kiln.

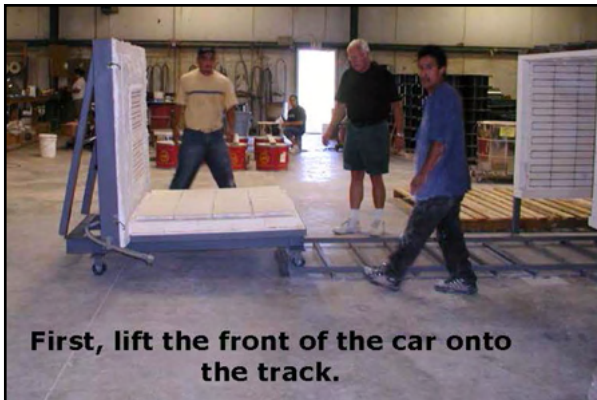

Olympic Electric Car Kiln Installation Instructions

Important Operating Information

The power to the door and floor is through a plug. Do not open the kiln without unplugging the plug.



To protect the floor and floor elements, kiln shelves and posts should be placed before firing the kiln.

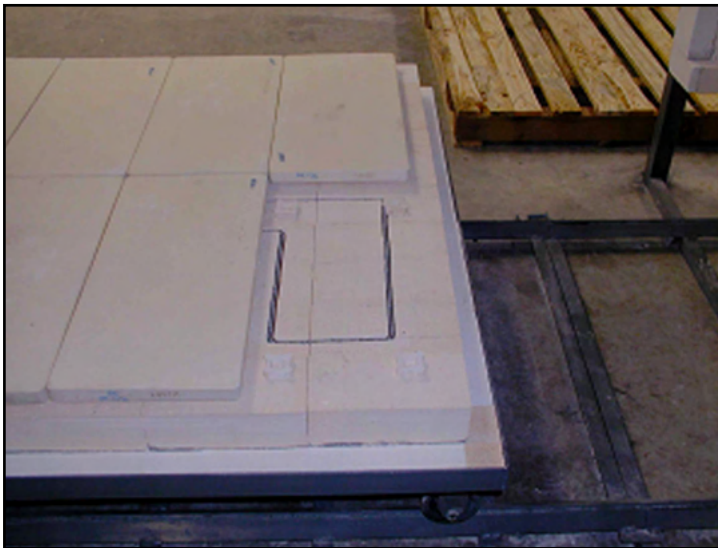

Infinite Switches

Large capacity electric kilns which are equipped with floor and door elements have infinite switches which control the heat intensity of the elements in the floor; and the left and right side of the door. Some models have infinite switches to control the heat intensity of the wall elements as well.

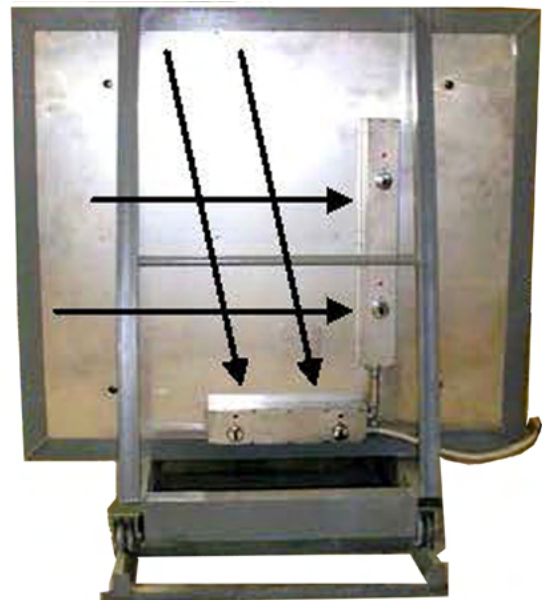

Electric Kins – Other Components

Elements

Your kiln is equipped with iron-chrome Kanthal A-1 type elements, suitable for high fire use. The elements are pinned in place to prevent contraction and intrusion into the firing chamber.

Kiln elements will become brittle after a few firings, so care should be taken if handling is necessary. When your kiln is first turned on, it is normal for the elements to hum for a short time and the clicking sounds you hear are from the relays turning the elements on/off as they go through the firing cycle.

An element is designed to have a very long life and is capable of many firings. The lifespan can be shortened considerably by contact with materials such as bits of bisque, glaze, glass, cones, metal, or kiln wash. Keep your elements clean by vacuuming the inside of your kiln regularly.

Observation Holes/Plugs

The observation holes of the kiln allow viewing of the firing chamber and pyrometric witness cones used in pottery and ceramics. They also provide an escape for water vapor and gases. The tapered shape and mortar coating of the “peep hole” insure a good fit for an observation hole plug, and eliminate abrasion of the brick by the observation hole plug.

Using dark glasses or a number five welders lens when looking through an observation hole can reduce excessive glare from a hot firing chamber. Observation hole plugs are hollow ceramic and should be treated with care.

Pilot Light

Electric kilns have a pilot indicator light, which illuminates when the kiln is activated.

Lid Prop

Many of the Olympic models come with a brick wedge to prop the kiln lid during the early stages of firing. The wedge is of soft brick and will not abrade the refractory coating of the lid. **DO NOT USE OTHER ITEMS SUCH AS KILN FURNITURE (SHELVES AND POSTS) AS A PROP SINCE THIS WILL DETERIORATE THE LID AND THE KILN BRICK.**

BRICK WEDGES ARE NOT TO BE USED ON OVAL LIDS AND ARE NOT INCLUDED IN KILN ACCESSORY BAGS FOR COMMERCIAL, OVAL, HB64, HOTBOX, HB86, OR FRONT LOADING MODELS.

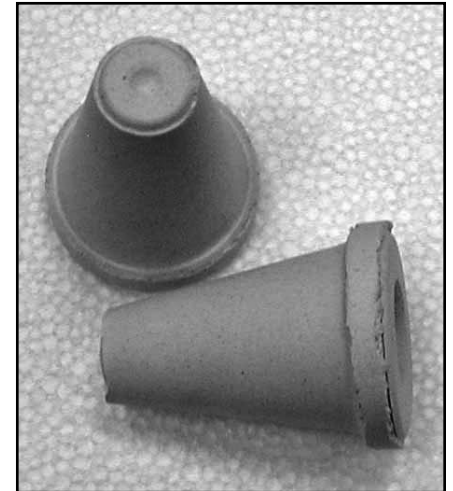

Observation Hole Plugs



Pilot Light

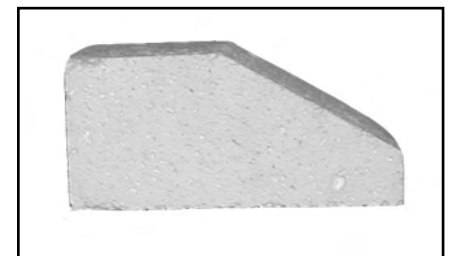

Lid Wedge

Electric Kilns – Other Components

Kiln Stand

Your kiln must be fired only on the metal stand provided. The space beneath the kiln is necessary for air circulation, and prevention of heat build up. **ALWAYS** make sure the stand or frame is level to avoid problems such as glaze flow, kiln sitter activation.

Power Cord

If your kiln is equipped with a power cord, **do not add extension cords** to the kiln's power cord plug. Doing so will void the warranty of the product. The power cord on a kiln is heavily insulated and designed to meet UL requirements. A standard extension cord will not be able to handle the power and may cause a fire hazard.

Electronic Controller Operating Overview

Olympic electric kilns are equipped with the Bartlett Instruments 3-Key-Cone-Fire, V6-CF, RTC-1000, or Genesis electronic controller. Please read the manual provided with your kiln for detailed operating instructions for the controller equipping your kiln.

Cone-Fire Firing

Cone-Fire mode is based on pyrometric cones. Although the controller fires the kilns electronically, every ceramic firing should include shelf or witness cones. They measure heat work accurately and give a history of the firing. If you fire the same sized load and type of ware regularly, the shelf cones let you compare one firing to the next and alert you when something is wrong. For example, if the shelf cone bends farther and farther with each consecutive firing, this may indicate thermocouple temperature drift. The Orton Ceramic pyrometric cone charts on pages 57-58 show end temperature range for slow and fast cone firings.

Vary Fire – Ramp/Hold Firing

Vary Fire mode on the V6-CF controller or Ramp/Hold on the RTC-1000 controller are designed for heat-treating, glass fusing and enameling firings. Use Vary Fire or Ramp-Hold to fire ceramic pieces that require a custom firing schedule, such as some types of stoneware sculpture or crystalline glaze.



Visit YouTube for video instruction on all of the Bartlett controllers. <https://www.youtube.com/watch?v=ByB9darhG7w&list=PLeVfwLwmcYHxyzaqWuj4cb5nr1uDYVg>



V6-CF



RTC-1000



3 Key-Cone Fire



Genesis

Genesis Controller – Refer to Genesis Operating Manual and Bartlett Instruments web site for regular updates for the controller – www.bartinst.com and YouTube.



<https://www.youtube.com/watch?v=j-yqKH5Cpaw>

KILN EQUIPPED WITH KILN SITTER

Refer to kiln sitter manual for operating instructions.

BARTLETT V6-CF CONTROLLER

STEPS FOR CONE FIRING

Step 1: Turn the kiln on and the message will display ERRP, press 1, which clears the display. Idle will display alternately with the room temperature flashing on the controller display.



Step 2: Select one of the options for cone firing. You can think of the Slow and Fast bisque as firing the kiln at Slow, Slow-Medium speeds and the Slow and Fast Glaze as firing the kiln at Medium and Fast speeds. In other words, you can use the Fast Glaze for bisque firing if you want the kiln to fire as fast as it can.

Once you select the option, press ENTER.



Fast Bisque Display on Controller Board



Slow Glaze Display on Controller Board



Cone-Fire Side of Controller Board

Slow Rate Firing Bisque or Glaze

Slow to Medium Rate Firing Bisque or Glaze

Medium Rate Firing Bisque or Glaze

Fast Firing Rate Bisque or Glaze

Step 3: Enter the cone number you wish to fire; example – Cone 05, press zero and five and then press ENTER.

Step 4: The controller will display HLD, asking if you need a hold time. If no, press 0000 and ENTER. If yes, press the number of minutes and press ENTER.

Step 5: The controller display will read CPL for complete. You may now press START and the kiln will be firing.

BARTLETT V6-CF CONTROLLER



There are several options available. Delay Firing – If you choose to delay firing, after entering your cone fire program, press the delay button on the left side of the controller board. Choose the number of hours desired. Press 8, 0, 0 to program the controller to begin firing 8 hours after you press Start. The number of hours should display before the decimal point, minutes after the decimal point.

Another option is PreHeat. when you are unsure of the dryness of the ware you will be firing, PreHeat can be selected to fire the ware at 200°F per hour for a selected period of time. This will ensure the ware is dry and ready to be fired when the firing program begins. Press the Menu button and continue pressing until the controller display PRHT. Press Enter and then press the number of hours you wish the kiln to preheat the ware until the firing program begins. The controller will automatically set the preheat temperature to 200°F per hour.



Vary-Fire Side of Controller Board

Vary-Fire allows kiln operators to create their own cone fire programs or other type firing programs for glass, metals, enameling, glaze, etc. There are six (6) User programs with eight (8) segments per program.



When Vary-Fire is pressed, USER with a number (1-6) will display. For your first program press 1, Enter for USER 1.

The control board will flash SEGS for segments to determine the number of segments you want in your program. Choose the number from 1-8 and press ENTER.



BARTLETT V6-CF CONTROLLER



After the number of segments has been entered, the control board reads RA 1 for the rate in rise of temperature per hour for the first segment. You can also decrease temperature by following the same steps and entering a lower end temperature at the completion of the segment.



Enter the temperature rate 200°, 350°, etc.; for the desired rate of rise and press ENTER.

If you want the kiln to fire as fast as possible to the target temperature in a segment, enter 9999 and press ENTER.



The control board will display °F 1 for the target temperature you want to reach in the first segment. Enter the temperature and press ENTER.



The control board will display HLD1 for the hold time for the first segment. If a hold time is required, enter the number of minutes; if there isn't any hold time, enter 0 and press ENTER.



The control board will display RA 2, °F 2, HLD2 for the second segment and so forth for the 3rd-8th segments. Once all the segments are entered, the control board will flash ALRM for alarm. Press 9999 unless you need an alarm to alert you when the program is completed.



Press Start to begin firing your program. The User program(s) remain in the controller's memory until new information is entered.

BARTLETT RTC-1000 CONTROLLER

This controller is used primarily with glass, heat-treating, jewelry and enameling kilns. There are six User programs with eight segments per program. Segment programming is determined by the rate of rise or decline in temperature required per segment with a target point temperature and hold.



The RTC-1000 controller allows the kiln operator to add time or skip a segment during a firing. If you find during a segment that you need to increase your hold time, press ADD TIME (2) and you will be able to increase the HOLD time in that segment. If you find you need to skip a segment in one of the USER programs, when the segment comes up during the firing, press 9 and SStP will appear. Press ENTER and the segment will be skipped during the firing.



Press ENTER if the controller displays ERRP for power failure. The display should then read IDLE and you are ready to begin entering your program.

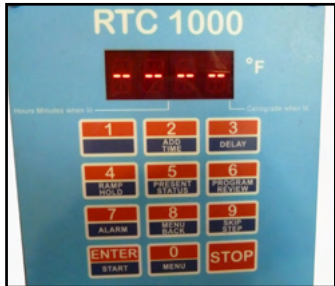

Press ENTER again and ---- will be displayed. From ---- press Ramp/Hold (4) and USER 1 will appear. There are six programs in the controller identified as USER 1-6 with eight segments per program.

target point temperature and then press ENTER.

The controller will request how many segments you will need or will already have a number flashing. A segment is a rate of rise in temperature per hour, which reaches a target point temperature and then press ENTER.



The controller will then ask what the rate in rise or decline (change in temperature) is required for the segment. The controller will display rA 1 for segment 1, rA 2 for segment 2 and so forth. Enter the amount of degrees (example 300° F) you want the kiln temperature to rise per hour and then press ENTER. You can also decrease temperature by following the same steps and entering a lower end temperature at the completion of the segment.



For each segment, °F1 or °C1 (°F2 or °C2, etc.) will display. The controller is asking for the end temperature you want the kiln to reach in the designated segment (example 1250°F) and enter the target temperature and press ENTER. The controller will ask if you need to Hold for a certain amount of time during the current segment. Enter the minutes or hours you need and press ENTER.



BARTLETT RTC-1000 CONTROLLER

When you have entered all your segments the controller will display ALAR for alarm. If you do not require an alarm, press 9999 so that the alarm will not go off and press ENTER. If you require an alarm, enter the temperature you want the alarm to sound.

The controller will display CPL for complete, press ENTER if you are ready to fire and then press START for the kiln to begin firing.

The USER programs stay in the controller's memory until new information is entered.

DELAY allows you to delay firing until you are ready. After you have entered your program and the START key, press DELAY, press ENTER, and the number of hours later you want the kiln to begin firing. Enter number of hours and press ENTER.

The controller will ask what end temperature you want the kiln to reach in the designated segment (example 1250°F), enter the temperature and press ENTER. The controller will request a hold time, choose the hours or minutes needed and press ENTER.

When all the segments have been entered for a program the controller display will show ALAR for Alarm. If an alarm is required, enter the number of hours in which you want the alarm to sound. If you do not need an alarm, enter 9999.

The controller will display CPL for complete, press ENTER if you are ready to fire and press START for the kiln to begin firing.

The User programs remain in the controller's memory until new information is entered.

DELAY allows firing to begin at a later time. After a program has been entered and the START has been pressed, press DELAY, press ENTER and the number of hours of delay before the kiln begins firing. Press ENTER.

The RTC-1000 controller has the capability to add time or skip a segment during a firing. If you find during a segment that you need to increase the holding time, press ADD TIME (2) and you will be able to increase the hold time in the segment. If a segment needs to be skipped, press 9 when the segment comes up and SStP will appear. Press ENTER and the segment will be skipped during the firing.

RTC-1000 Cone Fire Programming

Apply power to the kiln and the display will flash WAIT/IDLE. Press ENTER and ---- will appear. Press 1 and Cone will flash. Enter the cone number you wish to fire and press ENTER. SPd for speed will appear press 1 (fast), 2 (medium) or 3 (slow) and press ENTER. HOLD will display on the controller. If a hold time is desired enter the minutes or hours and press ENTER. Press ENTER Idle and flashing temperature will display. Press ENTER again and 4 lines ---- will display, Press ENTER and the display will read ON. The kiln will begin firing the cone fire program.



ERROR CODES **for V6-CF, RTC-1000 & GENESIS** **Electronic Controllers**

A good general method of trouble shooting is to cut the problem in half and determine which half is causing the problem. Then continue cutting the problem in half until you can diagnose the problem. For example, when a controller display shows fail, the problem can be due to the thermocouple (T/C) or the controller. If we disconnect the T/C and short the controller's T/C input connections together and the problem goes away, we know the problem was the T/C and not the controller.

Another second practical approach is to determine what has changed or what is different. Was anything done differently with the problem firing from previously good firings? For example, has the load increased significantly, is there a new program, have the elements been changed, is there a new thermocouple? Is the program similar to another program that is working properly? Try to determine what differences there are between the two programs.

ERROR CODES for V6-CF, RTC-1000 & GENESIS Controller

Error Condition – Err0

Err0 indicates a software failure caused by hardware or electrical noise. Probable causes are an electrical spike or surge, or arcing across the relay contacts. To correct this error, try resetting the system by disconnecting power for 10 seconds, then reconnecting the power. The controller will display 'ErrP'. Check that your current firing program wasn't cleared from memory by pressing "Review program". If your program reviews correctly, you can restart the kiln. If the error persists, the controller must be serviced or replaced.

Error Condition – Err1

Err1 indicates temperature is rising slowly (less than 12 deg/hr over a 22.5 min period) during a ramping phase.

Causes include:

- Worn or old heating elements
- Low voltage to the kiln
- A broken heating element
- Faulty relay
- Burned or broken wires to the elements or relays
- Electrical noise
- Faulty thermocouple (T/C)

If the kiln reached a temperature greater than 1300°F before getting the Err1 messages, then the most likely cause of the error is worn elements or low kiln voltage. You should begin by running the "full power test" and if all the elements heat, check the resistance of the elements according to the kiln manufacturer's guidelines. Also, check the voltage to the kiln to ensure it matches the voltage listed on the kiln's specification plate.

If you received the Err1 message and the firing reached a temperature less than 1300°F, one bank of elements is probably not firing. Run the "full power test" to determine which bank of elements is not working. Look for broken wires or broken elements. If the elements have the correct resistance, then a relay is most likely faulty.

If Err1 occurs at random temperatures, the cause is most likely electrical noise from the relays. The pilot relays should have MOV's (Metal Oxide Varistors) across the contacts of the relays. The MOVs subdue the noise caused by the relays. If the varistors are faulty or not present, the electrical noise generated may cause an Err1 message.

ERROR CODES for V6-CF, RTC-1000 & GENESIS Electronic Controllers

A chattering relay can cause excessive noise as well. Boards damaged by electrostatic discharge (ESD or static charges) are more susceptible for electrical noise and a new board may correct the situation.

If the actual temperature appears to be hotter than the indicated temperature when Err1 occurred, the problem is generally related to a faulty or old T/C.

Error Condition – Err2

During a hold segment the temperature is more than 50°F above the hold temperature which was set. The temperature must stay 50°F above this set temperature for 18 seconds before the error is displayed.

The most probable cause of this is either a relay stuck on or a stuck output on the controller. First, stop the kiln. If all the relays remain on, then it is probably a controller problem. If only one section (or relay) remains on, then it is a stuck relay.

Error Condition – Err3

During a hold segment the temperature is more than 50°F below the hold temperature which was set. the temperature must stay 50°F below this set point for 18 seconds before the error is displayed.

Opening the door or lid of the kiln can cause this. However, Err3 is generally caused by a burned-out element or a defective relay. Run the “full power test” to isolate the problem section. If not sections are heating then the controller outputs may be bad. If only one section is not heating, follow the kiln manufacturer’s procedure to test the element. If the elements are all good, then the problem is most likely a defective relay.

Error Condition – Err4

The firing is in a ramp segment where the temperature is programmed to decrease and the temperature is more than 50°F above the previous hold temperature. The temperature must remain 50°F above the hold temperature for 18 seconds before the error is displayed. Err4 is the same as Err2 except that Err4 occurs during a ramp phase rather than a HOLD.

The most probable causes of Err4 are either a stuck relay or stuck output on the controller. If all the relays remain on while Err4 is displayed, then probably the controller output is stuck on. If only one section (or relay) remains turned on then the problem is a stuck relay.

It is also possible to get an Err4 message if you use the skip step feature. If you get Err4 after skipping to the next ramp phase, press a key to clear the error, allow the kiln to cool to within 50°F of the next hold temperature, restart the kiln and skip steps until you get to the segment you want.

Error Condition – Err5

The temperature is more than 50°F below the local set point during a ramp segment where the temperature is programmed to decrease. The temperature must stay 50°F below this set point for 18 seconds before the error is displayed.

This can be caused by opening the door or lid. However, it is generally caused by bad element or relays. Run the “full power test” to isolate the problem section. If no sections are heating then the controller outputs may be bad. If only one section is bad, follow the kiln manufacturer’s procedure to test the non-heating element. If the element tests good, the relay is most likely the cause of the problem.

ERROR CODES for V6-CF, RTC-1000 & GENESIS Electronic Controllers

Error Condition – Err6

A negative temperature is displayed. This can be caused by using the kiln in temperatures below 0°F (or 0°C). If this is the case, warm the T/C manually before starting the kiln.

Other reasons for Err6 are the T/C connected backwards (red and yellow leads reversed), the board has been damaged by static electricity or ESD (electrostatic discharge), or electrical noise. If the T/C was not just changed and previous firings have been OK, then the problem is either a defective circuit board or electrical noise. Do the “T/C by-pass test”. If the temperature reading is negative, the board has been damaged and needs service. If room temperature is displayed with the T/C screws shorted together then the thermocouple (T/C) is the problem.

Error Condition – Err7

Error 7 is not implemented at this time.

Error Condition – Err8

When using the Cone Fire Method, the temperature is decreasing during the last ramp segment, usually indicating the kiln sitter has turned the kiln off.

Error Condition – ErrE

A hardware error has been detected by the controller’s software. The controller must be returned for service.

Error Condition – ErrA

ErrA indicates that the controller failed the self-check of the non-volatile memory chip where all the programs are stored. You need to reprogram all 6 user programs. Turn the controller off then back on. If you do not get the error again, continue as normal. However, if you continue to get ErrA then the board needs to be serviced.

Error Condition – ErrH

ErrH indicates that the Analog to Digital Converter did not pass the self-check diagnostic test on reset. If you get this error, then the board will need to be serviced.

Error Condition – Errb

Errb indicates that the controller is reading a board temperature above 250°. This means the actual temperature is above 250° or the board needs to be serviced.

Error Condition – Errt

An Errt indicates that a write cycle to the non-volatile memory chip took too long. The board will need to be serviced.

Error Condition – ErrP

A continuous ErrP in the display indicates a long-term power outage. The kiln has been shut down. Press “1” to clear the display.

ERROR CODES for V6-CF, RTC-1000 & GENESIS Electronic Controllers

If ErrP and the current temperature are alternately flashing, this indicates a short-term power outage. To clear the display, press the "1" key. If a firing was in progress, it will continue.

If you are getting an ErrP message during a firing without having a power loss, this indicates the controller is being reset by radio frequency (RF) noise. This electrical noise can be generated by the relay. When a relay drives an inductive load (i.e., mercury displacement contactor) it generates electrical noise; to suppress this noise, varistors (MOVs or Metal Oxide Varistors) must be placed across the contacts of the relay. Locating the controller circuit board away from the relay, contactor, and high voltage wiring will also reduce the effects of the electrical (RF) noise.

Error Condition – StUC

If 'StUC' appears on the display, one of the keys is stuck. The controller needs to be returned for service.

Error Condition – FAiL

Fail indicates that the controller is not getting a thermocouple (T/C) input; therefore, it cannot determine the temperature. The first thing you will need to do is disconnect the thermocouple (or thermocouples if you have more than one) and perform the "T/C By-pass test". If the controller displays room temperature with the T/C bypassed then you will need to replace the thermocouple.

If you are getting Fail during a firing and the "T/C By-pass test" is successful, but a new thermocouple does not fix the problem, then you will need to watch the temperatures during a firing to see if they are erratic. You could be having interference due to electrical noise.

Other Controller Related Firing Symptoms:

Stuck display

No display

Overfire

Underfire

Does not heat when start is pressed

Temperature does not cool

Jumpy display

If this error occurs without a kiln sitter attached, a faulty relay, broken element, or electrical noise could be the cause of the problem. Do the "full power test". If all the elements glow at a low temp, let the test proceed and make sure they continue to glow at high temperatures.

To troubleshoot zone control kilns, first set the display to read Idle, tc 1, and temperature. Apply heat to the top T/C. If the temperature increases then T/C 1 is connected correctly to the top section of the kiln. If the temperature does not rise, apply heat to the other two T/Cs to see which is connected to T/C 1. Check all of the thermocouples and move them to the correct positions if needed.

If a thermocouple is in the correct location but it does not register a temperature increase then the T/C is faulty or its lead wires are shorted together.

If all of the T/Cs are in the correct positions and register temperature increases, proceed to testing the outputs.

ERROR CODES for V6-CF, RTC-1000 & GENESIS Electronic Controllers

To test the outputs on controllers without the diagnostics routine in software, you will first have to disconnect power from the kiln. Remove the V6-CF controller and run the “full power test”. Only the top section should heat up. If another section is heating up instead, then remove the wire from Output 1 and put it on the output that corresponds to the section that is heating.

Repeat this procedure for Outputs 2 and 3 as well. If the problem persists, look for electrical noise sources or defective T/Cs.

To test the outputs on the controller using the diagnostics routine in software, press the “OTHER” button until ‘rSEt’ is displayed. Press “4”, “4”, “3” and “notC” will be displayed. Press the “OTHER” key until ‘diAG’ is displayed. Press “ENTER”. ‘OUt1’ will be displayed and Output 1 will come on; the top section of the kiln should start to heat. If the display and section heating do not match then remove the wire from Output 1 and place it on the correct output for the section that is actually heating. After about 1 minute, ‘OUt2’ will be displayed and the middle section of the kiln should heat. Similarly, Output 3 will come on after another minute and the bottom section of the kiln should heat. Make sure that the correct kiln section is heating compared to the output that is displayed.

Error Condition – Err–

The Err with a dash indicates there was a power loss to the controller while writing a program to the non-volatile memory chip. Check the selected program, and reprogram if necessary. If you get this error on a regular basis, the board may need to be serviced.

Error Condition – Errd

This error is triggered when the temperature is more than 100°F above the traveling set point. On a single or zone board this can be caused by a stuck relay or electrical noise. On zone control kilns, Errd is generally caused by crossed wiring of the T/Cs or the outputs.

BARTLETT 3 KEY-CONE FIRE CONTROLLER

The 3 Key-Cone Fire controller provides cone-fire and ramp/hold programming.

- When power is applied, the display will flash rC-A, Idle, the room temperature; example 77 for 77°F.
- The rC indicates the controller is programmed for cone-fire and ramp/hold.
- The letter (A) indicates the software version.
- If ErrP (means a loss in power) is displayed, press any key to clear this message.
- If StOP or IdLE is alternating with the current temperature, you are ready to begin programming.



Cone Fire Programming

STEP DESCRIPTION

1. Start with the display reading IdLE, Press "enter".
2. **Select cone fire.** If "C-Fr" (cone-fire) is displayed, press "enter", if "r-Hd" (ramp/hold) is displayed, press an arrow key $\uparrow\downarrow$ to display "C-Fr" and then press "enter".
3. **dELA will display for Delay Start – Set delay start** The beginning of the firing can be delayed from the time you press "start". This allows the firing to start later and end when you can supervise the end. Use the arrow keys to adjust the amount of delay and press enter. If you do not wish to delay the firing, enter all 0000 and press enter.
4. **PrH will display for preheat.** Enter the preheat time. The first segment of a cone fire program ramps to 200 F. The preheat time is the length of time you will hold at 200 F. Thin, dry clay may not need any preheat time and thick hand-built items may require several hours of preheat. Use the arrow key to adjust the preheat time and then press "enter" to store the value. REMEMBER the time is displayed in the form HH.mm. H= hours, m=minutes, so anything after the decimal point represents minutes and in front of the decimal point represents hours. If you do not need to preheat your items, scroll to 0000 and press enter.
5. **Enter Cone #.** Use the arrow keys to display the desired cone number. The up arrow moves toward a hotter cone number. Press "enter" to store the displayed cone number.
6. **Slo, nnEd, FAS will be displayed for Slow, Medium and Fast. Select heating rate.** Use arrow keys to display Slow, Medium or Fast.
7. **HLD is displayed for Hold Time. Enter hold time.** A hold at the top temperature adds heat work and can help produce a more even firing from top to bottom. Typical hold times are in the 10-15 minute range (00.15). Use the arrow keys to display the desired hold time and then press "enter" to store the value. If you do not need hold time scroll to 0000 and press enter.
8. **rEdl will display for Ready.** Press "enter" to start the firing.

BARTLETT 3-KEY CONTROLLER

Turn the kiln on. If the message ErrP is displayed, hit any key and Enter to remove. If StOP is displayed, you can begin entering your program.

Press the START STOP ENTER button.

dELa will be displayed asking if you want to delay firing of the program. If the answer is yes and you want the kiln to begin firing 5 hours and 30 minutes after you key in the program, press the up or down arrow until 530 is displayed and press START STOP ENTER. If you want the kiln to begin firing immediately, make sure four zeros are displayed and press the START STOP ENTER button.

This controller has 4 user programs with 8 segments per program. To enter a program you must scroll on the up arrow button to reach the desired number. Many of the messages displayed will look the same as they are on the RTC-1000 controller so please review information about both controllers.

SEG is the next message asking how many segments you desire to have throughout the firing. A segment is raising or decreasing of the temperature to a certain temperature in a period of time. Example: You have a piece that needs three segments:

- 1st segment raise temperature 150 degrees per hour to reach 900 degrees
- 2nd segment raise temperature 200 degrees per hour to reach 1800 degrees
- 3rd segment decrease temperature 150 degrees per hour to reach 1000 degrees

For a three segment program, use the up and down keys to reach the number 3 and press the START STOP ENTER button. rA1 is then being displayed (rate in rise/decline of temperature) to determine what the increase or decrease in temperature is. Use the up/down keys to enter the desired temperature and then press the START STOP ENTER button. F2 will display and you will use the up/down keys to select the end temperature of the segment and press the START STOP ENTER button.



HLdI is displayed requesting how long you want the end temperature of the segment to hold. If minutes, scroll up or down to the desired time. The number should display after the decimal point. If hours, scroll up or down to reach the time. The numbers should display before the decimal point.

rEdI is displayed after all the segments in a firing have been entered. Press the START STOP ENTER button to begin the firing. Once the kiln has fired, the display CPLt will show the kiln has completed the firing process. After the kiln has cooled down, your ware can be unloaded.

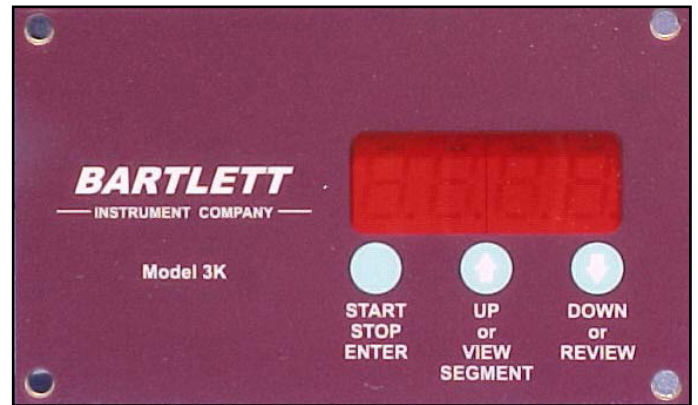

3 KEY-CONE FIRE CONTROLLER ERROR CODES

ERR 1: Element or Voltage Problem (Conduct a paper test and make sure voltage is correct for kiln; i.e. 240 volts needs 240 not 220 volts.) Paper test - Turn the kiln on, place scrap pieces of paper in each element trough and see if the paper burns. Elements need replacing where the paper doesn't burn.

ERRP: Indicates a long-term power outage. Press "1" to clear display.

FAIL or a Negative Temperature is Displayed: Check to see that thermocouple is properly connected; (lead wires may need reversing) or may need thermocouple replacement.

tC FAIL

tC alternating with FAIL: Indicates the thermocouple has failed. Replace the defective thermocouple. To clear the error, press any key.

ErrP ErrP is displayed whenever there is a power interruption that is long enough to stop the firing. If the power interruption is brief the kiln will continue to fire when power is restored; in this case there will not be any indication of a power failure. To clear the error, press any key.

tC- - The red and yellow thermocouple wires are reversed.

Messages

CPLt Firing Cycle Complete (firing time is alternately displayed).

dELA Delay. Displays when entering the delay time (hour:minutes) until the start of the firing.

°F #

°C # Segment temperature in °C – Set temperature for a user program. A decimal point will

EdIt

ErrP There has been a power interruption that has stopped the firing. Press any key to clear.

FULL Beeps continuously at end of firing until a key is pressed.

HLd# Soak time in hours:minutes at a hold temperature.

OFF No beeping when firing is complete.

On

rA # Ramp Number (rate per hour of temperature increase or decrease).

rEdl

SEG

SStP Skip Step (used to advance to the next ramp)

StOP The kiln is at idle and ready to be programmed. Stop alternates with the current kiln temperature.

USr # User program number displayed

ELECTRO SITTER – Available with 3 Key-Cone Fire, V6-CF, RTC-1000 or Genesis Controller



Electro Sitter will replace your obsolete kiln sitter equipped model! It's easy, and best of all, parts are available! The Electro Sitter box is complete with thermocouple attached, and it has the option to fire either cone-fire or ramp/hold programs. The box will fit where the kiln sitter/timer are attached to the kiln. Simply remove the screws from the kiln sitter on front of the kiln, then detach wires connecting to the kiln sitter. Wires will be attached to the back of the Electro Sitter exactly as they were attached to the kiln sitter terminal block.

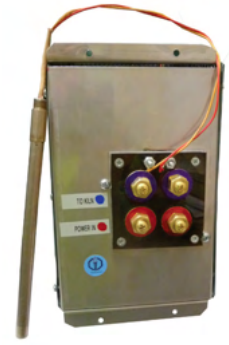

Kiln with kiln sitter



Detach screws from kiln sitter plate



Remove wires from back of kiln sitter terminal block

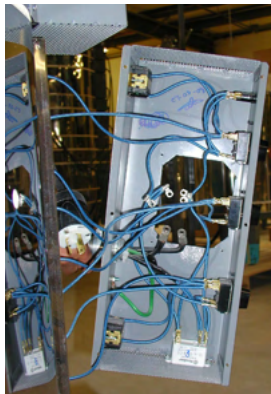

Electrical box without kiln sitter



Install Electro Sitter in the same location as the former kiln sitter plate.



Connect wires to back of Electro Sitter just like the connections to the back of the kiln sitter.

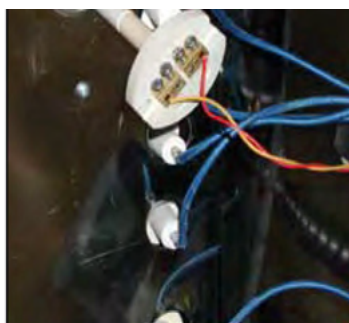

Insert thermocouple through kiln sitter hole



Thermocouple will show through brick wall at a maximum of 1". Pack kiln sitter hole with ceramic fiber to seal it.



Install electrical box back on kiln with Electro Sitter installed.

ELECTRONIC CONTROLLER WALL UNITS

Kilns wired for kiln sitters are wired differently from those wired for electronic controllers. An electronic wall unit may be added to a kiln sitter equipped kiln so they may run by controller; however because of the differences in wiring, the controller is placed on the wall and the thermocouple from the wall unit is placed inside the kiln. Wall units are available for 120 volt, 20-30-50-100- amp, and three-phase wired kilns with the choice of the 3 Key-Cone Fire, V6-CF, RTC-1000 or Genesis as the controller. The controller on the wall unit operates the same as if it was attached to the electrical box on a kiln.



To install the wall unit follow the steps below.

1. Attach wall mount control vertically to wall.
2. Plug or direct wire Wall Unit to the power source
3. Plug or direct wire the kiln into the wall unit
4. Drill a hole the size of the wall unit's thermocouple through the kiln wall and insert thermocouple from wall unit into the kiln. Insert thermocouple approximately 1" inside the kiln.
5. Place a junior cone that is one size hotter than you intend to fire into the kiln sitter and activate the kiln sitter.
6. Turn all switches on the kiln to the high setting.
7. Read electronic controller instructions thoroughly and follow programming instructions that best suit your firing requirements.



ZONE CONTROL

Kilns equipped with electronic controllers have the option of zone control. The standard built electronic control kiln has one zone, one thermocouple senses the kiln's temperature and sends the information back to the controller.

When a kiln is 2-zone or 3-zone, two or three thermocouples are placed in each section of the kiln to regulate temperature.

- 2-zone control has two thermocouples for the top and bottom section of the kiln.
- 3-zone kiln has three thermocouples, one in the top, middle and bottom section of the kiln.

Each thermocouple senses the temperature in the particular section it sets and can be read through the controller display by pressing the Options key. Infinite switches for each zone allow the kiln operator to manually adjust the element output as needed. To select an individual zone, press 1, 2 or 3 and the temperature of the selected zone will be displayed. Pressing 8 will illuminate indicator lights in the display showing which zone is on.

Lid Element

DUAL MEDIA KILNS

Dual Media kilns are designed to fire ceramics and glass

240-208 volt Dual Media kilns have a lid element for glass fusing. The kiln operator manually activates the lid element with the rotary switch. **The switch is turned to the desired intensity (0 - HI) when the lid element is in use.**



Infinite Switch for Lid Element Activation



Electric Raku Kilns

LOCATING YOUR KILN:

Three things should be considered when locating your Olympic Kiln:

1. Adequate space
2. Proper ventilation
3. Convenience of electric outlets

For the area that has been chosen, allow 12 inches of space between the kiln and the walls. All flammable materials such as curtains, plastics, etc. in the area of the kiln should be removed.

If the kiln is to be placed outside, it must be kept dry. Use a roof over the kiln or some type water resistant tarp when the kiln is not being fired. Because all kilns generate heat, the stand should be placed on a cement floor. Tiles or linoleum could be damaged without this precaution.

RAKUING

Planning –

- Reduction containers - (galvanized garbage cans are best) that are the correct size and are arranged for easy access and clear movement around the kiln. Grass, leaves, sawdust or shredded paper work well.
- Combustibles should be at a safe distance from the kiln, yet easy to reach during post firing process
- Helpers that know their job
- Arrange water sources for cooling and emergency situations
- Provide safe, clear avenues for unencumbered movement

Operating the kiln –

- Plug kiln into a receptacle that has an adequate breaker
- To operate kiln pulley system, unlock lever and turn the hand winch. Ensure winch is in a locked position before releasing the handle.
- **Use only raku clay pottery and raku glaze when rakuing.** This clay and glaze is designed for thermal shock the ware must go through, other materials may explode and damage the kiln as well as other pottery ware.

Begin heating the kiln with the fire chamber completely closed. The 120-volt electric raku kiln may take approximately 2 hours to reach raku temperature; however, the 240/208-volt electric raku will reach temperature in about 60 minutes. As the kiln reaches approximately 1900° Fahrenheit begin loading your ware. To preheat and avoid thermal shock to your ware, slowly lower the raku-firing chamber. Maintain full power when opening to minimize heat loss between pieces.

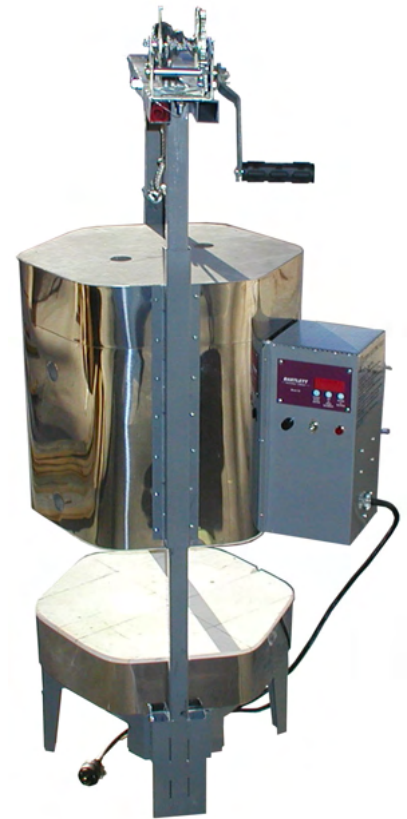

Electric Rakus Equipped with an Electronic Controller

3 Key-Cone-Fire Controller

- Choose User 1 - 4 using the **Start, Stop, Enter** button for the program
- Choose one segment when the controller requests how many segments and press ENTER.
- For rate in rise of temperature per hour press 9999 and ENTER. (9999 tells the controller to reach the end temperature as quickly as possible.)
- For end temperature press 1900 - 1950° F and press ENTER.
- For hold time, enter the number of hours you plan to raku and press ENTER.
- The controller will display rEd1 for Ready and you may press START to begin heating your kiln.

The program will be saved in the User program number you selected until new information is entered in the select program.

V6-CF Controller

- Use the Vary Fire Method side of the V6-CF controller to run the raku firing.
- Choose User 1 - 6 for the program and press ENTER.
- Choose one segment when the controller requests how many segments and press ENTER.
- For rate in rise of temperature per hour press 9999 and ENTER. (9999 tells the controller to reach the end temperature as quickly as possible.)
- For end temperature press 1900 - 1950° F and press ENTER.
- For hold time, enter the number of hours you plan to raku and press ENTER.
- The controller will display CPL for Complete and you may press START to begin heating your kiln.

The program will be saved in the User program number you selected until new information is entered in the select program.

Around 1900-1950° Fahrenheit the raku process will begin to take place. You can tell the ware is ready to remove by its shiny, wet appearance. Raise the firing chamber; remove pieces with tongs and place in reduction containers as quickly as possible. Once ware is inside the container add more reduction material and cover within 15 seconds to ensure efficient smoking. (It is not how much reduction material you use, but how fast you can get pottery ware into the container and covered that provides exceptional raku pieces.) Keep container covered for 15 minutes - 1 hour. After ware has cooled, wash each piece to remove soot and carbon.

Olympic Raku kilns are designed to maintain their temperature (even when the firing chamber is lifted) so that you can continue the raku process without interruption. Once ware is removed from the kiln and placed in reduction containers, new items may be loaded in the kiln. You may also want to place items on top of the raku-firing chamber (on the outside) that you will be raku next so that they are preheated before placing in the kiln.



Loading Kiln for Pottery & Ceramics

Follow these instructions when loading your kiln:

1. Load only bone-dry greenware (unfired clay shapes) into the kiln. Wet ware may crack on firing or even explode resulting in damage to the other ware or the kiln. Ceramic greenware should be dried for at least two days with larger or thicker pieces requiring even longer. Glazed (painted) ware should dry for six hours before firing.
2. Plan the load before starting. Arrange the load so that thick and thin walled pieces will be mixed throughout the kiln to give a uniform mass or density.
3. It is best not to load pieces directly on the kiln bottom.
4. The bottom layer should either be stilted or loaded on a shelf supported 1/2 inch from the bottom to allow adequate air circulation and heat distribution.
5. Place small, low pieces on the bottom layer, and taller pieces on the top shelf. This enables loading with shorter posts.
6. Allow at least one element groove between every shelf. If your kiln has a blank ring, let at least two element grooves contribute to the heating of the blank space.
7. Do not jar or shake the kiln after loading has started since ware on a shelf could be knocked down or broken.
8. Keep shelves and ware at least 1 inch from the thermocouple, and 1/2 inch from the wall of the kiln. At least one element groove must be between the top shelf and the top of the kiln.
9. If large flat pieces are being fired, the edges should be placed between elements. This may eliminate possible cracking from uneven heating.
10. Place the shelves in the kiln carefully so the walls of the kiln will not be bumped and damaged.
11. If a witness cone is being used, the cone should be placed 3 inches behind the observation hole so it will be completely visible.

Loading Low Fire Bisque

Be sure the greenware is dry before loading. Greenware that feels cool is probably still damp. You can compare the temperature of the ware to be fired to an old piece of greenware that you know is dry.

Greenware can touch other greenware as well as the kiln shelves. Kiln washed shelves are not necessary when bisque firing.

It is best to fire a piece in its natural position, however large flat items such as wall plaques or clocks should be fired on a flat side to prevent ware from warping.

Thin cups may be fired upside down or stacked lip-to-lip if the rims are strong enough. Canisters and other pieces with lids should be fired with lids in place for a good fit.

Loading Low Fire Glaze

Do not place greenware and glazed ware in the same load. The gases emitted by the greenware clay body can cause discoloration of the glaze. If it is necessary to mix glaze and bisque in a load, the glazed pieces should be loaded in the lower part of the kiln with the greenware above it.

Do not load red family glazes, green, yellow, or yellow-green glazes, metallic or luster glazes with greenware. Allow a minimum of 2 inches of space around red glaze pieces. Again, if it is absolutely necessary to mix loads, always place the red glazes on a shelf below other items, which may contaminate.

Glazed pieces must not touch or they will stick together. At least 3/4 inch must be allowed between glazed pieces to prevent contamination from the release of bubbles and gases from other glazes.

Loading Kiln for Pottery & Ceramics

The tops of shelves and kiln bottom must be kiln washed to protect against drops of glaze. The kiln lid and the underside of shelves must be clean to prevent dust particles from falling on the glazed ware.

Glazed ware must be stilted and dry footed to prevent sticking to the shelves. (Dry footing is removing all glaze from the portion of the piece that will rest on the shelf. A wet sponge or piece of cloth can be used for this.) For low fire (cone 04, 05, 06) glazes, stiling is recommended. If a piece wobbles when stilted, it may fall during the firing. Be sure all stilted pieces are solid. Note: Be sure your hands are clean when loading glaze.

Loading Overglaze

(China paints, lusters, metallics applied over a glazed surface and fired.)

Overglaze ware is loaded in the kiln in the same manner as ordinary glazed pieces. Ware must be prevented from sticking by the use of stilts, and care should be taken so pieces do not touch each other.

Plates will fire best when supported by a rack or when placed on edge to permit even heating. Plates fired on edge may be supported at the bottom with stilts.

Spacing is important when firing lusters, to prevent contamination.

China paints should be applied in light coats, and fired between coats until the desired shade is reached. China paints applied too heavily will crack and peel.

Loading Porcelain Bisque

Porcelain is a high fire clay body, which vitrifies (becomes non-porous) when fired. Loading porcelain bisque and glazed ware is similar since both will stick to anything when being fired.

Stilts cannot be used to support porcelain bisque as they will adhere to the porcelain when heated to high temperatures.

Porcelain bisque and glaze are always fired resting flat on surfaces coated with high fire kiln wash. Two pieces of ware that are to be used together must be fired together, such as a piece with a lid. Powdered silica (flint) must be applied at any point where contact is made.

Hollow rolls of porcelain clay shaped to hold up the parts that may sag should support pieces that are likely to warp during firing. Apply silica at the points of contact to prevent the supports from sticking. To prevent distortion due to uneven heating, never place a piece of porcelain closer than 3/4 of an inch from the sidewalls of the kiln.

Loading Porcelain Glaze

Porcelain glaze requires loading which allows good spacing between the pieces with at least 3/4 of an inch between the piece and the kiln wall. All glazed ware should be dry footed since stilts cannot be used on porcelain. It is important to have a good coating of high fire kiln wash on the shelves and bottom of the kiln. Pieces with lids and other items, which have been fired together in the bisque, cannot be fired together in the glaze firing since they will stick together. Shrinking has already occurred in the bisque, so the piece will still fit after the lower temperature glaze fire.

Loading Stoneware

(A non-transparent clay body requiring a high temperature to vitrify – a glassy non-porous state caused by heat or fusion.)

Stoneware greenware items must be bone dry before firing. Stoneware should be handled and loaded in the same manner as porcelain. Stiling of greenware is not required. For glaze firing, the tops of the shelves must be coated with kiln wash, and the ware should be dry footed.

Kiln Firing

Firing is probably the most important part of your ceramic work. All of your previous work on a ceramic piece can be spoiled and your kiln permanently damaged from careless loading or firing.

Firing is usually accomplished by bisque firing followed by a glaze firing. The bisque firing allows the dried clay to harden enough so it can be handled, yet remain porous enough to accept glazes or stains.

The bisque piece having been glazed or decorated is fired a second time to mature the decorative covering. Some pieces may require more than two firings.

Maturity of clays and glazes occurs at different times and temperatures. ***Always check the firing temperature recommended by the glaze manufacturer or clay supplier to be sure.***

If during a firing you suspect something has shifted inside the kiln or something is abnormal, ***shut the kiln off immediately.*** Allow the kiln to cool, check the load, reenter your program and re-fire as usual. The same procedure should be followed if the kiln shuts off by itself prematurely.

Standard Firing Schedules for Full Kilns

Bisque or low fire glaze firings (cone 04-06) usually require 5 to 7 hours. Porcelain and stoneware high firings take from 6 to 10 hours. The following firing schedule *is a recommendation only* and can be used for all types of ceramic, porcelain, and stoneware firings. You should experiment with firing times and adapt your firing schedule to fit your type of firing. Some types of ceramics can be fired much faster than the recommended standard firing schedule, while other types of ware may require slower schedules. Keep a record of your firings, so any deviations resulting in good firings may be repeated.

If kiln has a vent, skip numbers 1 & 4.

1. If the kiln has a lid wedge, prop the lid after loading the kiln.
2. Plug all observation holes except the top, which should remain unplugged throughout the firing to allow a vent for fumes and vapors.
3. Key in the cone fire method you wish to fire.
4. After approximately 1 hour 45 minutes remove lid wedge and close the lid.
5. Allow kiln to fire until it shuts off.

A partially loaded kiln fires faster than a full one, so when firing partial loads, increase the length on LOW and MEDIUM to extend firing time.

Firing Ceramic Bisque

(A ceramic piece which has been fired, but not glazed.)

Bisque firing allows the clay to mature, and burns out any impurities which may be present. A fired piece is less likely to absorb moisture, which will cause cracking or “crazing” of the glaze during the glaze firing. Bisque should be fired at least one cone hotter than glaze (usually cone 05 or 04). Pieces likely to be subjected to thermal shock, such as cups and plates should always be fired to cone 04.

Most cast pieces can be fired satisfactorily on a fast firing schedule. Heavy or thick pieces require a much longer firing schedule.

Kiln Firing

Firing Underglaze

If the underglaze is applied directly to the greenware, the cone 05-04 bisque fire will also serve as the underglaze firing. Underglaze applied to bisque, should be fired within a range of cone 019-04 before the application of a glaze.

Firing Low Fire Glaze

(A coating of glass, which is fused to the surface of a clay body during firing. It serves to prevent the penetration of liquids, present a good wearing, easily cleaned surface, and decoration.)

Ceramic glaze fires like ceramic bisque except it should be fired one cone lower. Glaze firing can usually be accomplished faster than bisque firing since the critical moisture release has already occurred.

Check the glaze manufacturer's firing recommendations for the proper firing cone. Some glazes may require modification of the standard firing schedule to obtain satisfactory results. For example, red family glazes tend to come out better if the kiln is vented and fired rapidly.

Firing Overglaze

Overglazes are fired only to the softening point of the glaze, and are fired to lower cones than regular glazes. Most china paints, metallics and lusters are fired from cone 021 to 018.

China Paints

Check the manufacturer's cone recommendations for each color and type of ware being fired. Different china paint colors do not mature at the same cone even when fired on the same piece of ware. It is necessary to fire the colors maturing at the highest temperatures first, and add lower temperature colors and fire again. Colors mature at lower temperatures on ceramic pieces than on porcelain or stoneware due to the lower melting temperature of the host surface.

Firing Porcelain Bisque and Glaze

Porcelain is usually fired to cone 5 or 6. Porcelain bisque should be fired slowly. Porcelain may be bisque fired more than one time or soaked (hold time) for 30 minutes to obtain additional translucence. Porcelain glaze is not fired as high as porcelain bisque. Usually cone 3 is sufficient. Porcelain does not need to be supported to prevent warping during glaze firing but must be dry footed (removing all glaze from the bottom of the piece before firing).

Overglaze fired on porcelain is just like overglaze fired on ceramics only several cones hotter, usually cone 017-015. Overglaze may also be applied directly to porcelain bisque.

Firing Stoneware

Stoneware is usually bisque fired to cone 016-04 before glazing with an extended firing time to allow for the extra thickness of most stoneware pieces. Stoneware glaze applied to a bisque fired piece is fired on a normal heating cycle since the moisture has already been removed. Firing temperatures depend upon the glaze and stoneware body, however cone 1 to cone 8 are the most commonly used.

Kiln Cooling and Unloading

Your kiln is designed to cool best when untouched after it shuts off. Forced cooling such as withdrawing the observation plugs or opening the kiln door while the kiln is still hot, greatly increases the risk of damage to both the ware and the kiln.

The kiln should cool at least twice as long as it fired. Pieces should be removed from the kiln only after they are cool enough to handle with bare hands. If the ware is under fired, it may be fired again to maturity.

Kiln Maintenance

The life of the kiln can be extended for many extra trouble-free years of service if routine maintenance is performed. This maintenance should include, but not limited, to the following suggestions.

Every Firing

Examine the interior of the kiln to insure it is clean and free of dust. Check the lid and wall brick for loose fragments, which might fall on the ware. If possible, vacuum the interior to remove all dust and foreign material from the elements.

Check the floor of the kiln, and the kiln shelves to be sure the coating of the kiln wash is adequate for your firing. Also check for any warping or cracks in the kiln shelves that might affect your firing.

Remove any contaminants from the walls, bottom or shelves of the kiln prior to the next firing. If this is not done, particles will melt and spread with each firing, causing contamination to the elements, thermocouple and deterioration of the firebrick.



Protect your ware by vacuuming kiln to remove dust particles and debris

Studio Models

Expansion and contraction of the kiln during firing will eventually cause the stainless steel jacket/rings to loosen and cause the kiln to get out of alignment. To prevent this, the clamps on the jacket, lid and bottom of the kiln should be tightened occasionally with a screwdriver **when the kiln is warm**. Care should be taken not to strip the clamps. By following this procedure you will eliminate wires being stretched and burned out requiring you to purchase new parts.



*Digital multi-meter
volt-ohm ammeter*

Repairs

Many repairs can be accomplished on your kiln simply by removing an old or damaged part and inserting a new one. For more complex repairs, and certainly for troubleshooting, a volt-ohm meter (VOM) is a valuable tool. A VOM can check the continuity of your kiln, pick out weak

elements, reveal faulty switches, or check for proper voltage from the wall receptacle. The VOM allows the troubleshooter to proceed in a logical sequence through the kiln for the source of an electrical problem.

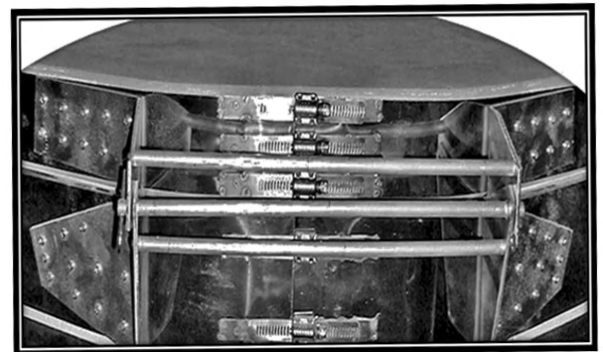

Repositioning Lid when Thermal Expansion Occurs

When doing replacement repairs, install the new part in the same position as the old part. Transfer wires one at a time from the old to the new part. Discolored wires and lugs must be replaced or cleaned with sandpaper or steel wool until clean and bright. If this is not done, a bad connection will result.

NOTE: To insure you receive the correct element or part, order from Olympic Kilns. Elements and parts ordered from other sources may not function correctly in your kiln.

Replacing Parts

Removal of Electrical Box

1. Unplug or unwire kiln if direct wired
2. Remove the screws attaching the electrical box to the heat shield
3. Pull the box away from the kiln. When removing the electrical box that contains the pyrometer or electronic controller, be careful to pull the box straight out so that the thermocouple does not break the brick.

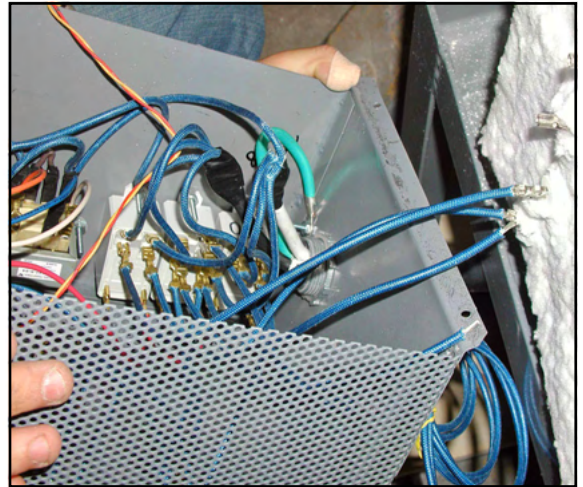
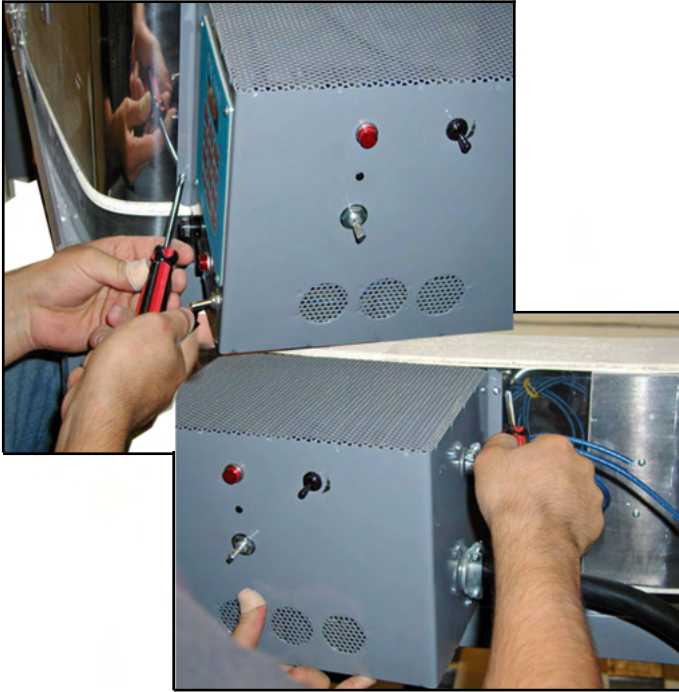

Replacement of Interconnecting Plugs and Receptacles on Stackable Electric Kilns
The interconnecting plugs and receptacles have changed over the years. To order replacement parts Olympic Kilns requires the model and serial number of the kiln and a description of the type inter-box plug and receptacle your model has.

Remove the electrical box that contains the part that needs replacing. Loosen the screws holding the interconnection to the electrical box. Note the position of the prongs and reinstall the new part in the same position. The interconnecting plug and receptacle can be ordered pre-wired and to replace the old part with new, remove and replace one wire at a time.



Old style Interbox Plug & Receptacle



*Twist 'n' Lock
Interbox Plug & Receptacle*

Replacing Parts

After the electrical box or boxes are removed from the kiln, the following repairs can be accomplished.

Switches, Relays & Transformers – These parts are all replaced by removing the slip-on connection from the old part and replacing slip-ons to the new part.

120 volt – 240 volt Infinite Switch Schematic

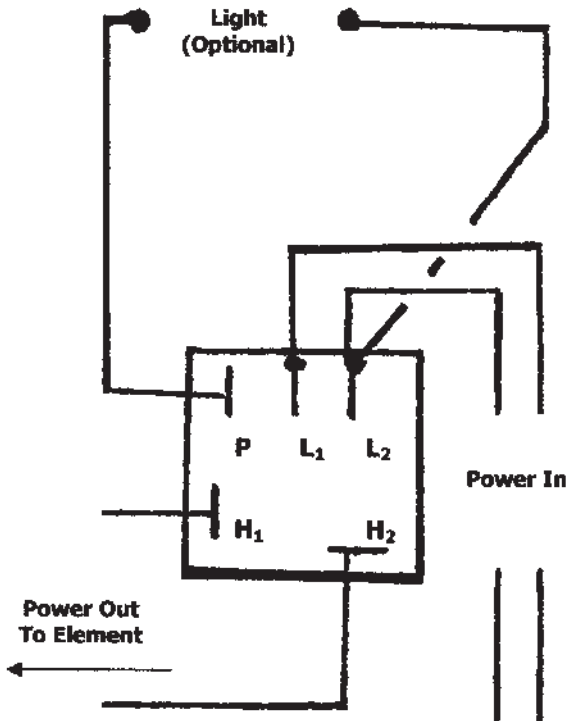

Infinite Switch with Wiring Diagram

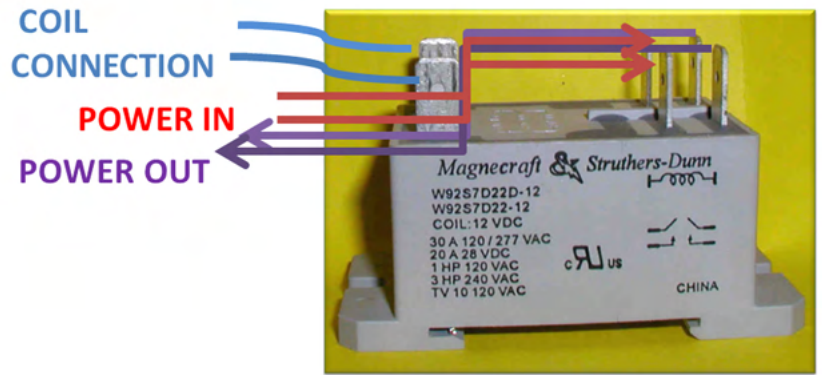
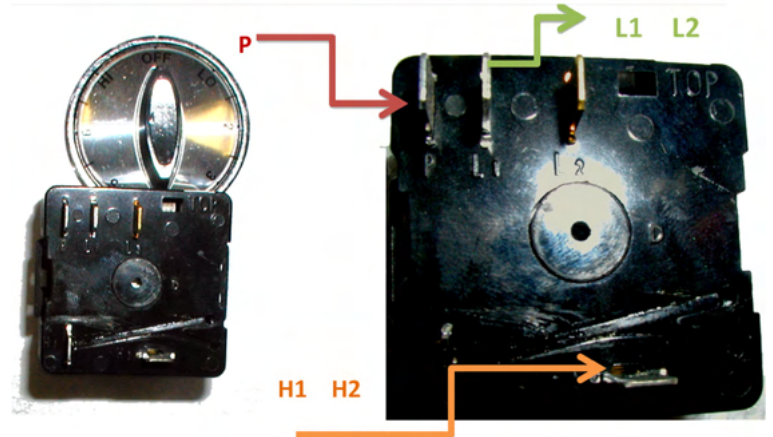

Wiring Schematic for 12, 120 & 240 Volt Relay

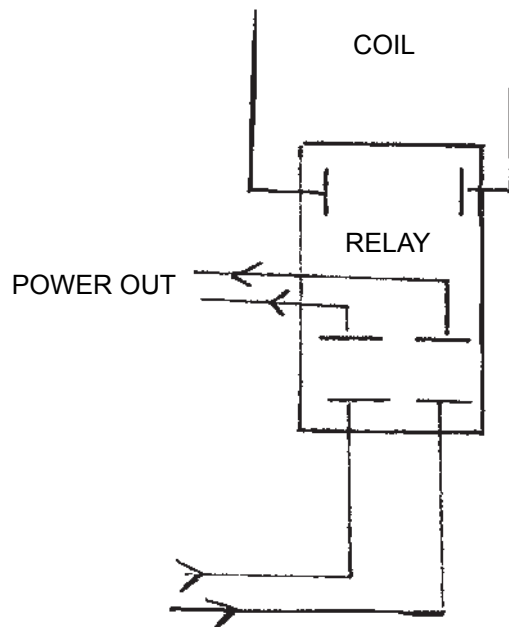

Replacing Parts

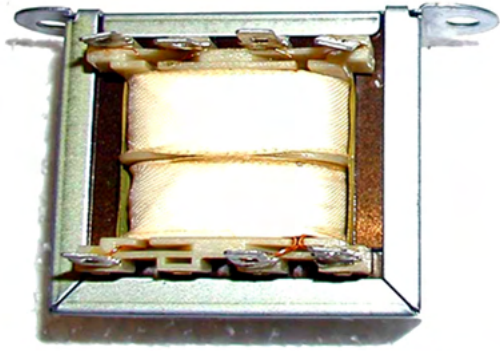

120 VOLT

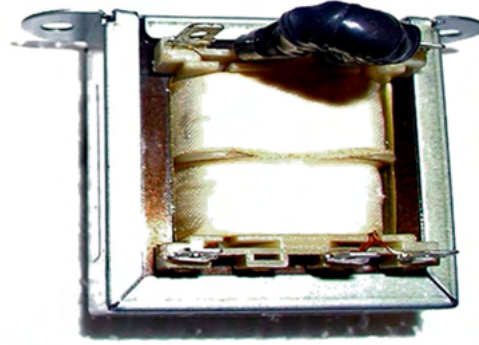

240/208 VOLT

Transformer Wiring Schematic 208/240 Volt Transformer 120 Volt – Power in 4 & 3 or 1 & 2

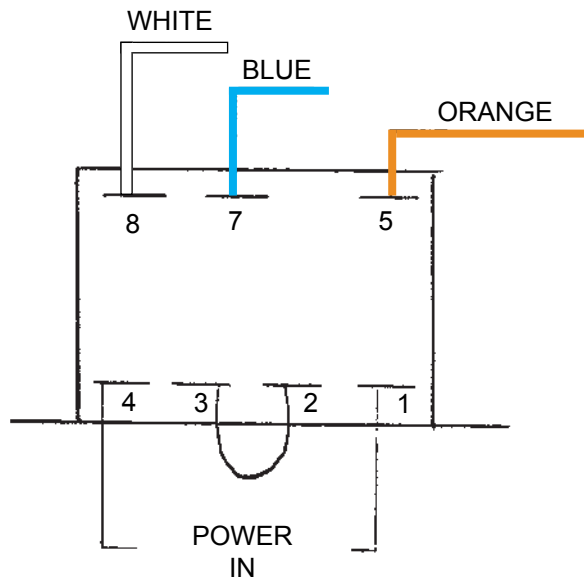

Replacing Parts

Thermocouple Replacement –

Thermocouple designs can vary based on the age of the kiln. This is the current design for the Type K thermocouple. You may need to enlarge the hole in the kiln where the thermocouple is inserted to accommodate the new thermocouple.

It is extremely important that the ceramic fiber enclosed with the thermocouple be used to eliminate any air space in the hole where the thermocouple is inserted. Failure to comply will result in a defective thermocouple. The thermocouple must be insulated to avoid excess heat.

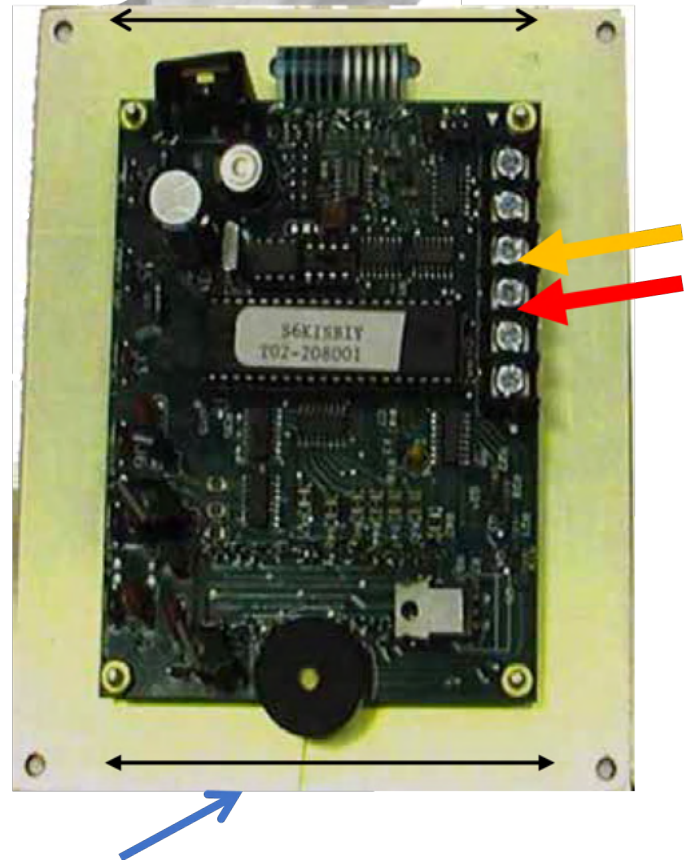
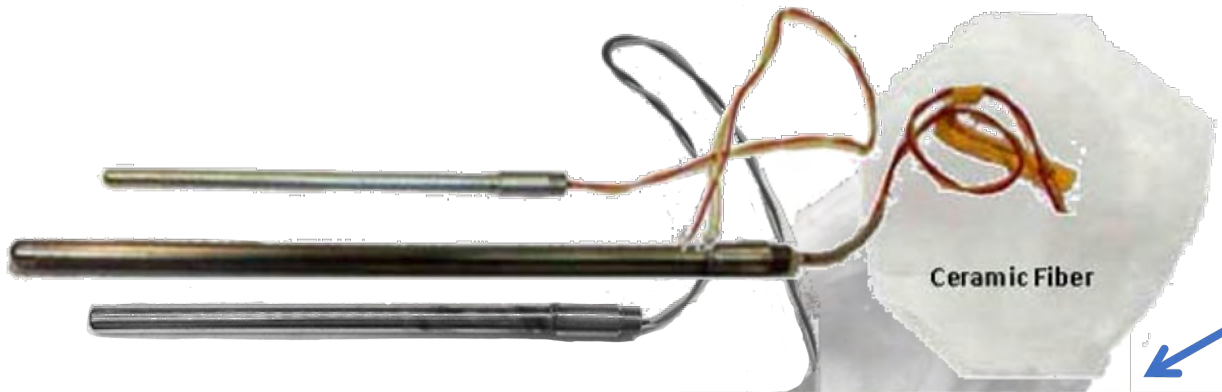

Remove four screws attaching board to electrical box.

Replacing Parts

Thermocouple Replacement –

Remove the four screws attaching the controller board to the electrical box. Strip the thermocouple's yellow and red wires 3/8 of an inch. Disconnect defective thermocouple and insert the new thermocouple with the fiber through the opening in the kiln brick. Set the thermocouple approximately 1" inside the kiln firing chamber. Attach thermocouple's yellow wire to the positive connection on the electronic board and the red wire to the negative connection.

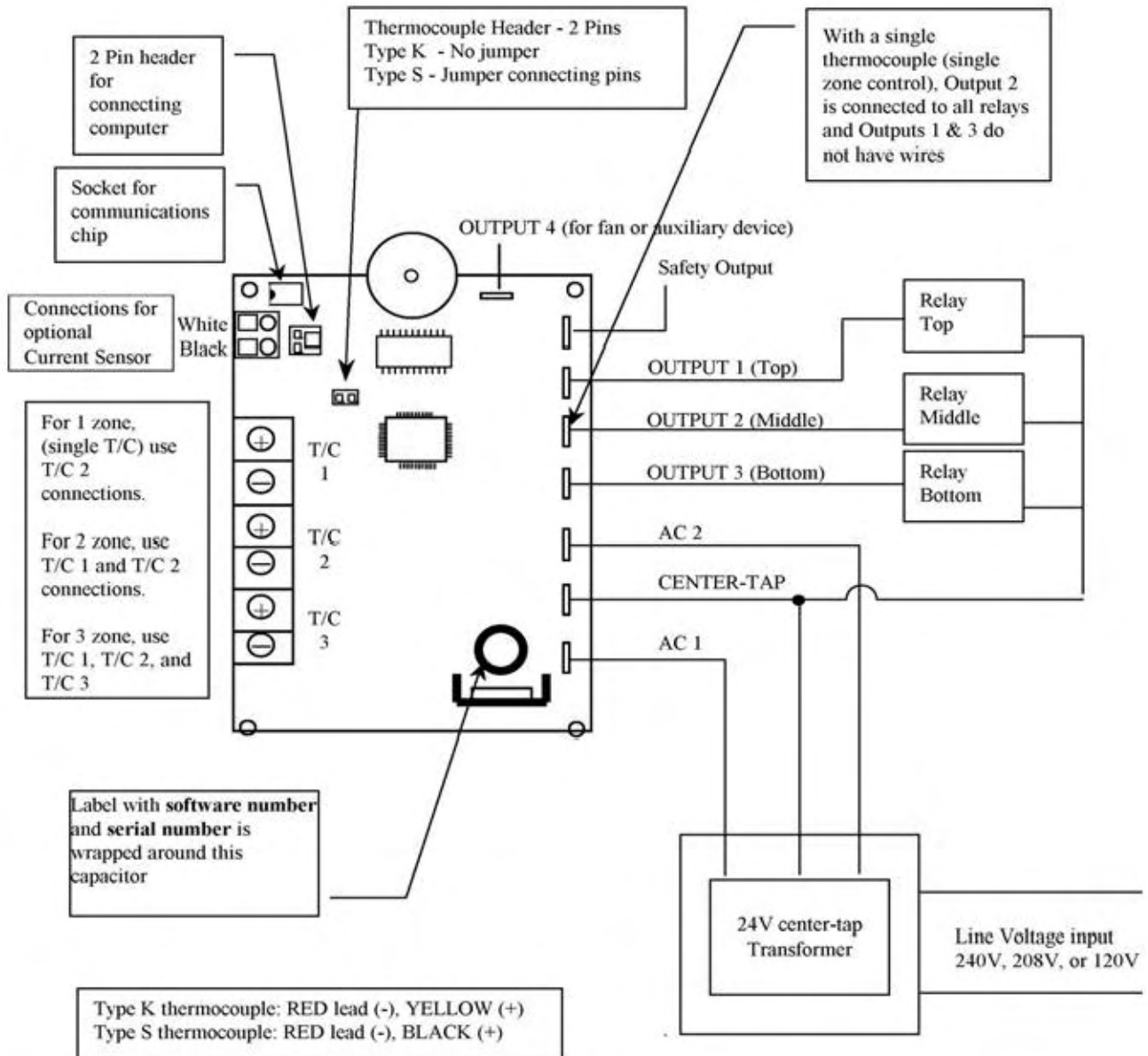

Replacing Parts

Element Re-Pinning

Elements become very brittle after a few firings; so if re-shaping or re-pinning is necessary, heat the element either by turning on the kiln, or with a torch to a dull red glow. Unplug or unwire the kiln, and reposition the hot element using needle nose pliers. A brittle element normally will not break if it is above 500 degrees F.



As a kiln ages, the element will begin to bulge. At this time the number of pins will not help keep the element in the lid. Your best solution is to replace the element with a new element.

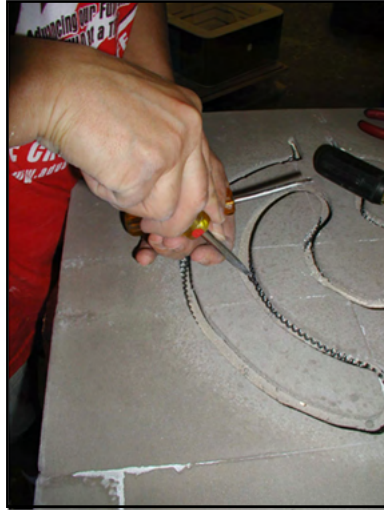

U-shaped pins are used to pin elements in the lid element troughs of the glass kilns.

Replacing Elements

1. Turn off kiln and unplug or unwire if direct wired and remove all pins holding the defective element in the grooves.
2. Gently remove the old element taking care not to break or chip any bricks. Long needle nose pliers can help in this job.
3. Insert one twisted pigtail of the new element through the terminal brick and then work toward the other end by carefully placing the new element in the trough of the brick. Make a slight bend at each corner so that the element takes the shape of the kiln. When the entire element is in the trough, it may be necessary to slightly stretch or compress it to obtain the length necessary to allow the pigtail to pass through the brick.
4. Re-pin the element at each corner with Kanthal pins. **The pins should hold the element down while the lip of the element groove holds the element in.**



Replacing Parts

5. Reinstall the porcelain insulators over the twisted pigtail.
6. Pull the pigtail out gently until it is tight, then clip it 5/16 inch beyond the insulator.

Hi Temp Connectors



7. Place a high temperature connector in the jaws of the crimping tool and hold it lightly. Reach inside the kiln with the other hand and push the pigtail out. Slip the connector on the pigtail and crimp firmly in two spots.



Crimping Tool

8. Strip 5/16 inch from the wires connecting the switch or relay to the elements. Polish with fine sandpaper if the wires are discolored, then firmly re-crimp.

It is important to stress that the wire in a crimped connection be clean and bright. All crimps must be firmly applied.

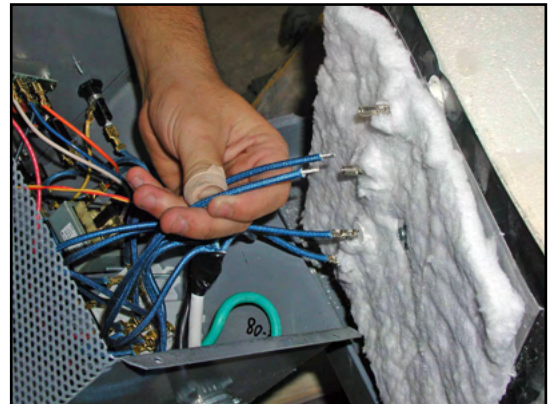

Replacing Parts

Element Replacement – Tips for Electric Rakus – TopHats

The best way to replace elements in an electric raku kiln is to remove the firing chamber from the frame. Once the firing chamber has been removed from the frame, loosen the stainless steel band, remove the top from the firing chamber and follow the steps for element replacement. After the elements have been installed, replace the lid of kiln on the firing chamber and reinstall the firing chamber to the kiln frame.

Brick Repairs

The bricks used in your kiln will withstand many firings without deteriorating. Brick replacement is complicated by the risk of breaking a brittle element. Often temporary repairs can be made until the time that an element needs replacing.

It is difficult to cement bricks together when they break, however, large pieces such as the element groove lip, can be pinned with Kanthal pins to hold it in position. If the brick cannot be pinned, the element may be held in position with pins, even if the supporting brick below the element is missing.

Foreign material such as glass spots on the brick can be dug out with a screwdriver or knife.

Brick Replacement

Make sure you order the correct brick(s) that need replacing.

Straight Notched – bricks that elements run through

Terminal – the brick that the element runs through to the electrical box

Observation – the brick that has the observation hole

Blank – brick that is not grooved for element placement

Terminal bricks are best replaced when elements need replacing as well.

1. Remove the Kanthal pins securing the element at each end of the damaged brick.
2. One section kilns and brick being repaired in the top section of stackable kilns, requires the lid to be removed by unscrewing the large hinge parts attached to the kiln jacket.
3. If the kiln is built in sections, place the ring with the broken brick on a flat surface with the damaged side up.
4. Loosen the hose clamps until the bricks are loose. If the kiln is in one section and the repair is being made on other than the top row, the entire stainless steel jacket must be opened.
5. Gently lift the elements from the trough with needle nose pliers, and carefully bow them far enough into the firing chamber to allow removal of the brick. Insert the new brick with the element trough to the bottom of the kiln.
6. Set the elements into the groove and pin down.
7. Tighten the jacket clamps taking care to align observation holes. Replace all screws and replace the lid if it was removed.
8. Use sandpaper over a wooden block to sand the brick down until it is even with the adjoining brick.
9. Vacuum the kiln.
10. Retighten the stainless steel jacket of kiln again during firing while the kiln is hot.

Olympic commercial electric kiln bricks are mortared together and replacement requires cutting out the brick. Please contact Olympic Kilns for additional instructions.

Replacing Parts

Floor Repairs

The easiest repair to make when the floor is damaged is simply to turn it over. A one-piece kiln must be turned upside down and the hose clamps on the jacket loosened, allowing the floor to be lifted out of the kiln. The floor can then be turned over and reinstalled.

Holes in the floor can be patched with kiln wash mixed to the consistency of paste, then scraped flush, and allowed to dry before firing. Kiln mortar can also be used by spreading it thinly over the area to keep it sealed.

Lid Repairs

If the lid becomes chipped or damaged, simply smooth the surface of the hole with sandpaper and blow or vacuum clean. Kiln mortar may be spread thinly over the exposed brick to seal it and prevent dusting.

Large Capacity Electric Kilns and Car Kilns are built differently from the studio line of electric kilns. Please contact Olympic Kilns for repair troubleshooting for these models.

Kiln Troubleshooting

Kiln does not start.

Check to see that kiln is plugged in and the pilot light turns on. Kilns equipped with electronic controllers, the controller must read Idle to begin programming the kiln. Electronic controller equipped kilns are protected by a fuse that must be checked if the controller display does not light up. If the fuse is in good condition and the controller display does not light up, then the transformer may need replacing. The toggle switch on 120 volt glass fusing kilns with a lid and body element must be in either the UP or DOWN position for the kiln to operate. The kiln will not fire in the NEUTRAL position.

Gap appears between lid and kiln when firing.

This is a common occurrence in oval and some top loading kilns when the kiln is heated and thermal expansion occurs. Lightly sandpaper the area on either side of the gap.

If the sandpaper does not correct the problem, while the kiln is firing, loosen the hinge screws to the kiln to allow repositioning.

The holes for the screws attaching the hinge are larger than the screws. If you will loosen the screws attaching the hinge to the lid, while the kiln is warm, then the lid can reposition itself. Once the lid is repositioned, tighten the screws, and the lid will be flush with the body (chamber).



Repositioning Lid when Thermal Expansion Occurs

Fuse or breaker fails after the kiln has been on for some time.

Check chart to insure the correct breaker size is being used with the kiln. Replace breaker or fuse if necessary.

Smooth ceramic fiberboard shelf has marks or patterns.

Lightly sandpaper mark or pattern with high-grade sandpaper.

Glaze Defects

Problems with fired ceramics can usually be traced to improper firing, poor color application, or some other correctable fault.

Black Specks – Usually the result of contamination from dirt. Contamination can be introduced by several things – a dirty brush, dirty green ware, dirty bisque, a dirty glaze container, or a dirty kiln. Make sure all of the above-mentioned are kept clean.

Blistered and Bubbled Glaze – This condition is the result of bubbles frozen in the glaze as the kiln cools. The bubbles are caused by gases released from under fired bisque or glaze. The bubbles and blisters can be sanded down, covered with a thin coat of glaze, and re-fired to a hotter cone. The piece may be soaked (hold time) for 30 minutes at the conclusion of the re-firing.

Kiln Troubleshooting

Color Peels Off – This condition is usually the result of too heavy an application of the glaze, dirty bisque, most likely from oil or grease preventing adhesion of the glaze, or too rapid cooling.

Cracks – Cracks are sometimes caused by uneven or too rapid heating or cooling of the kiln. Check the crack to see if it was caused during the heating or cooling. If the edges of the crack are sharp, it was made during the cooling of the kiln. If the cracks are rounded or smooth, this indicates the crack occurred when heating. To prevent this in future firings, slow the heating rate, do not pull the observation plugs while the kiln is hot and never force cool the kiln.

Cracking sometimes is caused by glazes that are not compatible, such as a mug or vase with clear glaze on the inside and colored glaze on the outside.

Craters – Craters are due to under fired glaze, and can be salvaged by dabbing glaze in the craters and re-firing to a hotter temperature.

Crazing – This is a fine network of cracks on the glazed surface. It is caused by under fired bisque, incompatible thermal expansion between the clay and glaze, or cooling too rapidly. Crazing can be corrected by re-firing the piece one cone hotter than the original firing. Some crazing will not occur for several months after the firing. The solution is still to re-fire the piece.

Faded Decals – Check the decal manufacturer's firing recommendation. Fading is either from over or under firing. If under firing is the problem, re-fire to the proper cone. Little can be done to save an over fired decal.

Glaze Creeps – Bare spots appear in glaze surface after firing. This can be the result of dusty, dirty bisque, or oil and grease from dirty hands. The latter causes the glaze to repel from these spots. Under firing or firing the piece before the glaze dries will also cause creeping. To save the piece, apply additional glaze to the bare spot and re-fire.

Luster Problems – Lusters will flake or peel if too thickly applied, and will frost if over fired. To salvage the piece, fire to cone 06 to burn off the luster. Reapply the luster and re-fire.

Metallic Problems – Metallics will appear dull if applied too sparingly or under fired. Over firing or too heavy an application of glaze will result in cracking. Under fired metallics can be re-fired to the proper cone, while over fired metallics must be burned off at cone 06, reapplied, and re-fired.

Pinholes and Pitting – As glazes and clay bodies mature, volatile materials are released, resulting in boiling and agitation of the glaze. An incomplete firing cycle causes these bubbles to freeze, causing pinholes and craters. Pinholes can be caused by too rapid heating or cooling of the kiln.

Orton Ceramic Pyrometric Cone Chart - Fahrenheit

Temperature Equivalent Chart for Orton Pyrometric Cones (°F) Cone Numbers 022-14



Pyrometric cones have been used to monitor ceramic firings for more than 100 years. They are useful in determining when a firing is complete, if the kiln provided enough heat, if there was a temperature difference in the kiln or if a problem occurred during the firing.

The temperature will be higher for faster heating rates and lower for slower heating rates.

Cone bending may also be affected by reducing atmospheres or those containing sulfur oxides. Orton recommends the use of Iron-Free cones for all reduction firings (cones 010-3). If a cone is heated too fast, the cone surface fuses and binders used to make cones form gases that bloat the cone. If cones are to be fired rapidly, they should be calcined (pre-fired) before use. Cones should be calcined to about 850°F (455°C) in an air atmosphere.

Cones are made from carefully controlled compositions. They bend in a repeatable manner (over a relatively small temperature range - usually less than 40° F). The final bending position is an indication of how much heat was absorbed.

Behavior of Pyrometric Cones

Typically, it takes 15 to 25 minutes for a cone to bend once it starts. This depends on the cone number. The cone bends slowly at first but once it reaches the half way point (3 o'clock), it bends quickly. When the cone tip reaches a point level with the base, it is considered properly fired. This is the point for which temperature equivalents are determined. Differences between a cone touching the shelf and a cone at the 4 o'clock position are small, usually 1 or 2 degrees.

for more information on pyrometric cones, contact Orton or visit us at www.ortonceramic.com



The Edward Orton Jr. Ceramic Foundation
P.O. Box 2760 • Westerville, OH 43086-2760
(614) 895-2663 • (614) 895-5610 fax
info@ortonceramic.com
www.ortonceramic.com

Cone	Self Supporting Cones						Large Cones				Small Regular	
	Regular		Iron Free		Iron Free (last 180° F of firing)		Regular		Iron Free		Regular	
	27	108	270	27	108	270	108	270	108	270	540	540
022	1087	1094					N/A	N/A				1166
021	1112	1143					N/A	N/A				1189
020	1159	1180					N/A	N/A				1231
019	1213	1252	1283				1249	1279				1333
018	1267	1319	1353				1314	1350				1386
017	1301	1360	1405				1357	1402				1443
016	1368	1422	1465				1416	1461				1517
015	1382	1456	1504				1450	1501				1549
014	1395	1485	1540				1485	1537				1598
013	1485	1539	1582				1539	1578				1616
012	1549	1582	1620				1576	1616				1652
011	1575	1607	1641				1603	1638				1679
010	1636	1657	1679	1600	1627	1639	1648	1675	1623	1636		1686
09	1665	1688	1706	1650	1686	1702	1683	1702	1683	1699		1751
08	1692	1728	1753	1695	1735	1755	1728	1749	1733	1751		1801
07	1764	1789	1809	1747	1780	1800	1783	1805	1778	1796		1846
06	1798	1828	1855	1776	1816	1828	1823	1852	1816	1825		1873
05½	1839	1859	1877	1814	1854	1870	1854	1873	1852	1868		1909
05	1870	1888	1911	1855	1899	1915	1886	1915	1890	1911		1944
04	1915	1945	1971	1909	1942	1956	1940	1958	1940	1953		2008
03	1960	1987	2019	1951	1990	1999	1987	2014	1989	1996		2068
02	1972	2016	2052	1983	2021	2039	2014	2048	2016	2035		2098
01	1999	2046	2080	2014	2053	2073	2043	2079	2052	2070		2152
1	2028	2079	2109	2046	2082	2098	2077	2109	2079	2095		2163
2	2034	2088	2127				2088	2124	2104	2120		2174
3	2039	2106	2138	2066	2109	2124	2106	2134	2104	2120		2185
4	2086	2124	2161				2120	2158				2208
5	2118	2167	2205				2163	2201				2230
5½	2133	2197	2237				N/A	N/A				N/A
6	2165	2232	2269				2228	2266				2291
7	2194	2262	2295				2259	2291				2307
8	2212	2280	2320				2277	2316				2372
9	2235	2300	2336				2295	2332				2403
10	2284	2345	2381				2340	2377				2426
11	2322	2361	2399				2359	2394				2437
12	2345	2383	2419				2379	2415				2471
13*	2389	2428	2458				2410*	2455*				N/A
14*	2464	2489	2523				2530*	2491*				N/A

These tables provide a guide for the selection of cones. The actual bending temperature depends on firing conditions. Once the appropriate cones are selected, excellent, reproducible results can be expected. Temperatures shown are for specific mounted height above base. For Self Supporting - 1 3/4"; for Large - 2"; for Small - 1 5/16". For Large Cones mounted at 1 3/4" height, use Self Supporting temperatures. * These Large Cones have different compositions and different temperature equivalents.

Temperature Equivalent Chart for Orton Pyrometric Cones (°C) Cone Numbers 022-14



Pyrometric cones have been used to monitor ceramic firings for more than 100 years. They are useful in determining when a firing is complete, if the kiln provided enough heat, if there was a temperature difference in the kiln or if a problem occurred during the firing.

Cones are made from carefully controlled compositions. They bend in a repeatable manner (over a relatively small temperature range - usually less than 40° F). The final bending position is an indication of how much heat was absorbed.

temperature. The temperature will be higher for faster heating rates and lower for slower heating rates.

Cone bending may also be affected by reducing atmospheres or those containing sulfur oxides. Orton recommends the use of Iron-Free cones for all reduction firings (cones 010-3). If a cone is heated too fast, the cone surface fuses and binders used to make cones form gases that bloat the cone. If cones are to be fired rapidly, they should be calcined (pre-fired) before use. Cones should be calcined to about 850°F (455°C) in an air atmosphere.

Behavior of Pyrometric Cones

Typically, it takes 15 to 25 minutes for a cone to bend once it starts. This depends on the cone number. The cone bends slowly at first but once it reaches the half way point (3 o'clock), it bends quickly. When the cone tip reaches a point level with the base, it is considered properly fired. This is the point for which temperature equivalents are determined. Differences between a cone touching the shelf and a cone at the 4 o'clock position are small, usually 1 or 2 degrees.

Temperatures shown on the charts were determined under controlled firing conditions in electric kilns and an air atmosphere. Temperatures are shown for specific heating rates. These heating rates are for the last 100°C or 180°F of the firing. Different heating rates will change the equivalent

for more information on pyrometric cones, contact Orton or visit us at www.ortonceramic.com



The Edward Orton Jr. Ceramic Foundation
P.O. Box 2760 • Westerville, OH 43086-2760
(614) 895-2663 • (614) 895-5610 fax
info@ortonceramic.com
www.ortonceramic.com

Cone	Self Supporting Cones						Large Cones			Small Regular	
	Regular			Iron Free			Regular				Iron Free
	15	60	150	15	60	150	60	150	60		
022	586	590	590								300
021	600	617	617				N/A	N/A			630
020	626	638	638				N/A	N/A			643
019	656	678	695				676	693			666
018	686	715	734				712	732			723
017	705	738	763				736	761			752
016	742	772	796				769	794			784
015	750	791	818				788	816			825
014	757	807	838				807	836			870
013	807	837	861				837	859			880
012	843	861	882				858	880			900
011	857	875	894				873	892			915
010	891	903	915	871	886	893	898	913	884	891	919
09	907	920	930	899	919	928	917	928	917	926	955
08	922	942	956	924	946	957	942	954	945	955	983
07	962	976	987	953	971	982	973	985	970	980	1008
06	981	998	1013	969	991	998	995	1011	991	996	1023
05½	1004	1015	1025	990	1012	1021	1012	1023	1011	1020	1043
05	1021	1031	1044	1013	1037	1046	1030	1046	1032	1044	1062
04	1046	1063	1077	1043	1061	1069	1060	1070	1060	1067	1098
03	1071	1086	1104	1066	1088	1093	1086	1101	1087	1091	1131
02	1078	1102	1122	1084	1105	1115	1101	1120	1102	1113	1148
01	1093	1119	1138	1101	1123	1134	1117	1137	1122	1132	1178
1	1109	1137	1154	1119	1139	1148	1136	1154	1137	1146	1184
2	1112	1142	1164				1142	1162			1190
3	1115	1152	1170	1130	1154	1162	1152	1168	1151	1160	1196
4	1141	1162	1183				1160	1181			1209
5	1159	1186	1207				1184	1205			1221
5½	1167	1203	1225				N/A	N/A			N/A
6	1185	1222	1243				1220	1241			1255
7	1201	1239	1257				1237	1255			1264
8	1211	1249	1271				1247	1269			1300
9	1224	1260	1280				1257	1278			1317
10	1251	1285	1305				1282	1303			1330
11	1272	1294	1315				1293	1312			1336
12	1285	1306	1326				1304	1324			1355
13	1310	1331	1348				1321*	1346*			N/A
14	1351	1365	1384				1388*	1366*			N/A

These tables provide a guide for the selection of cones. The actual bending temperature depends on firing conditions. Once the appropriate cones are selected, excellent, reproducible results can be expected. Temperatures shown are for specific mounted height above base. For Self Supporting - 1 3/4"; for Large - 2"; for Small - 1 5/16". For Large Cones mounted at 1 3/4" height, use Self Supporting temperatures. * These Large Cones have different compositions and different temperature equivalents.

This Warranty Is Applicable to All Kilns Manufactured by Olympic Kilns That Are Used for Ceramics, Pottery and Glass. Cone 10 Kilns Have a One-Year Warranty and All Other Kilns Have a Two-Year Warranty. Certain Parts, Thermocouple, Kiln Sitter Tube Assembly, Are Not Covered Under Warranty, Nor Is Kiln Furniture.

LIMITED KILN WARRANTY

Haugen Manufacturing, Incorporated guarantees to the original purchaser that any defects in OLYMPIC KILNS which become apparent within two years (one year for the Dawson Kiln Sitter and safety timer which is covered by warranty from W. P. Dawson, Inc. and kilns rated at cone 10) will be remedied as specified below.

Our warranty, of course, does not cover any kiln damaged or altered by you or others after it leaves our factory. Our warranty does not cover damage due to reduction or salt firing, over-firing, exceeding the maximum cone or temperature ratings, improper installation, use of electrical voltages different than those specified, or firing material other than ceramics.

If a defect of manufacturer becomes apparent, and your retailer does not resolve it to your satisfaction, we will in the following manner: Within (6;) days of the first indication of a defect, tell us in writing of defect, and the date, place and proof of the your purchase. We will contact you to determine what parts seem to warrant repair and to instruct you as to shipment of the kiln parts. You will dismantle, package, and ship the parts we request (and no others), to us at your cost, freight prepaid. If the kiln has a defect of manufacture we will repair, replace or refund as is appropriate, within (30) days. We will ship to you at our cost in your package, for you to reinstall at your cost. If the parts shipped by you to us are in need of repair or replacement for something which is not covered by this warranty, we will not perform the work until you have authorized the work and made arrangements for payment. If substantially an entire kiln is returned for repair under warranty, you will prepay the cost of packaging and shipping both to and from the factory.

We shall in no event be liable for injuries to persons or property or for incidental, contingent, special or consequential damages arising from the use of our products. Some states do not allow the exclusion or limitation of incidental or consequential damages, so the above limitation or exclusion may not apply to you. This warranty gives you specific legal rights, and you may also have other rights which vary from state to state.

HAUGEN MANUFACTURING, INC.
P. O. BOX 1347
4225 THURMON TANNER PARKWAY
FLOWERY BRANCH, GA 30542

REGISTER WARRANTY ONLINE

www.greatkilns.com

Go to Resources Tab and click on
Warranty Registration



www.greatkilns.com

Division of Haugen Mfg.

P. O. Box 1347, 4225 Thurmon Tanner Parkway • Flowery Branch, GA 30542
Sales (800) 241-4400 • Help Line (770) 967-4009 • Fax (770) 967-1196 • Email info@greatkilns.com