

OLYMPIC KILNS

www.greatkilns.com

GAS KILNS Operating Manual



Building the Finest Kilns for Your Creative Spirit!

Sales (800) 241-4400 • Help Line (770) 967-4009

P.O. Box 1347 • 4225 Thurmon Tanner Road • Flowery Branch, GA 30542

Congratulations!

You have just purchased the sports car of kilns – an Olympic Gas Kiln!

Get ready to move ahead with the power to fire:

- Raku
- Reduction Bisque
- Reduction Glaze
- Bisque
- Cone 10
- Glaze

Just see what you can do with your Olympic Gas Kiln!

REGISTER WARRANTY ONLINE

www.greatkilns.com

Go to Resources Tab and click on
Warranty Registration

CORRECTIONS of ERRORS and OMISSIONS

We have made every effort to ensure the accuracy of the information provided in this manual; however, we reserve the right to correct any errors and/or omissions found in this manual.

Table of Contents

Receiving Your Gas Kiln	4
Safety – Gas Kiln Firing	6
Frequently Used Terms	7
Gas Components	9

UpDraft Kilns 10

Raku & Torchbearer Gas Specifications and Model & Serial Number Identification	10
Locating Your UpDraft Gas Kiln	11
Gas Usage	12
Assembly & Preparation	13
Venting	14
Operation Options for UpDraft Gas Kilns	15
Loading UpDraft Gas Kilns	20

DownDraft Kilns 21

DownDraft Gas Specifications and Model & Serial Number Identification	22
Locating Your DownDraft Gas Kiln	23
Gas Usage	23
Assembly of DownDraft Gas Car Kilns	24
Venting	29
Operating Options for DownDraft Gas Kilns	30
Loading DownDraft Gas Kilns	37

Firing Schedule Examples 38

Bisque	38
Glaze	39
Sculpture	39
Reduction	39
Raku	41
Kiln Maintenance	42
Troubleshooting	43
Retrofitting Ignition Systems on UpDraft Gas Kilns	44
Orton Pyrometric Cone Charts	46
Warranty	48

RECEIVING Your Gas Kiln

Olympic Kilns packs and ships its merchandise so that it will arrive at its destination undamaged. Olympic Kilns' responsibility ends when the shipment is accepted by the carrier at our factory. We do not allow any deductions from invoices for damaged ware. It is the receiver's responsibility to understand and comply with standard shipping and receiving practices as described in this section.

The carrier is responsible for moving your freight but not for unloading it.

If you do not have a loading dock, a lift gate for moving the freight from the truck to ground level is required at delivery. You will need to request lift gate service when ordering your kiln from your Olympic dealer. Otherwise additional freight charges will be incurred upon delivery of freight. It is your responsibility to move the freight from the truck to its place of use.

If you do not have a loading dock, a lift gate for kilns on pallets no larger than 5 ft. x 5 ft. is available for moving the freight from the truck to ground level. Olympic Large Capacity Gas kilns above 12 cubic feet (inside dimensions) cannot be shipped on pallets as small as 5 ft. x 5 ft. You will need to have a forklift that can move the kiln from the truck to the desired location. If you do not have access to a forklift, check the yellow pages for small moving companies that can take the freight off the long-distance carrier and move the freight to the desired location.



Give any prospective mover a physical description of the kiln, the weight, and inform them that it is designed to be picked up with a pallet truck or forklift only. Check several sources for quotes so that you can get the best price.

RECEIVING Your Gas Kiln

Upon Delivery

You have the option of refusing delivery if the freight appears to be damaged. Check the count of the items ordered and note on the carrier's delivery receipt any shortages. If any damage appears on the outside of the packages, have the driver inspect the packages and note on the carrier's delivery receipt the damage.

Immediately after delivery, open all cartons to determine if there is any concealed damage.

- Retain all damaged items with their packaging
- Call carrier to report damage and request an inspection within 24 hours. If a call is made later than 36 hours, the carrier can deny your claim.
- Confirm call in writing by registered mail and keep a copy for your records.

Upon Carrier Inspection

Make sure the damaged items have not been moved from the receiving area prior to discovery of the damage. Allow the inspector to inspect damaged items, cartons, inner packing materials and freight bill. Be sure to retain your delivery receipt; it will be required as supporting documentation when a claim is filed. Once the inspector has filled out the inspection report, read it carefully and make sure you agree with the report. Unless repairs will be completely satisfactory, be sure the inspector requests replacement on the inspection report; otherwise a new item cannot be ordered to replace what can be repaired.

After Carrier Inspection

Continue to retain damaged merchandise even though the inspection has been completed. Damaged items cannot be used or disposed of without written permission from the carrier. Do not return damaged items to the shipper without written authorization from the supplier. If damaged items are picked up by the carrier for salvage, secure the receipt.

Documents Required for Filing a Freight Claim

- Your carrier's loss or damage claim form
- Shipper's original invoice or copy
- Original bill of lading
- Original paid freight bill
- Carrier's inspection report
- Repair invoice

It is the customer's responsibility (as consignee) to file any claim. Olympic Kilns is willing to assist you in collecting claims, but this willingness does not make us responsible for collection of claims or replacement of materials damaged or lost.

SAFETY

Your Olympic Gas Kiln has been built to fire at high temperatures and to run on natural gas or propane. Check with your local municipality to determine any codes you may need to follow to install a gas kiln.

A few notes before you begin firing your gas kiln will add to your enjoyment and safety.

Your gas kiln should be installed on a concrete, masonry or brick floor that is non-combustible.

Keep all flammable materials at least 6 feet away from the kiln and do not use highly flammable, combustible materials around the kiln such as gasoline, paint thinner, etc.

The surface of the kiln is hot and individuals should not touch the kiln when it is firing.

LIGHTING – The flame source (blow torch, gas match, fireplace match) needs to be long enough to keep the operator well away from the burner openings. When lighting, keep kiln door or lid open.

VENTILATION – A room must have adequate airflow into the room and exhaust gases must be vented in accordance with local requirements or codes.

GAS LEAKS – Whenever gas piping is modified, it should be pressure tested and at the same time soap tested. Never check for leaks with an open flame.

KILN WATCHING – A gas kiln should not left unattended.

FIRE EXTINGUISHERS – The best extinguisher for a gas fire is to turn the gas off. Make certain that everyone in the area knows where the gas valve is and how to turn it off. If the valve requires a wrench, hang it nearby. Fire blankets, sand pails and appropriate extinguishers should be available and everyone involved instructed in their use.

OBSERVATION/PEEPHOLES – Care should be used when viewing through the kiln's observation holes.

Safety suggestions are never complete and every situation will not be covered. Above all, use common sense and good judgement when firing your gas kiln.

FREQUENTLY Used Terms

BISQUE – The term given to ceramic ware which has been given a preliminary firing prior to glazing. Also called biscuit.

BURNER – A device in which air is combined with gaseous fuel and ignited at the burner tip.

BURNER BLOWER – An air fan, or blower, is used to provide air in quantities greater than the natural draft situation provides. This allows a greater amount of heat to be obtained from a burner of a given physical size.

BTU BRITISH THERMAL UNIT –

1 Cubic Foot Natural Gas = 1000 BTU / 1 Cubic Foot Propane = 2,200 - 2,500 BTU

CANDLING – The gradual heating of the kiln usually overnight, with a low flame (candle-size). The period of slow drying of the greenware before the kiln temperature is increased at its programmed rate. Omission of the candling period can likely cause explosion of greenware when the moisture expands as steam.

CLAY MATURATION POINT – Clay, or more appropriately, a clay body, when subjected to heat treatment, fuses and undergoes chemical changes which modify its strength, porosity may define the clay maturation point.

CFM – Cubic feet per minute, refers to volume of gas flow.

CFH – Cubic feet per hour, also refers to volume of gas flow.

COMBUSTION AIR – The total air intake to the firing chamber, which is used for combustion. Combustion air has two means of getting into combustion: Primary air: Air passing through the burner. (The air mixing plate controls the primary air intake. Secondary air: Air entering around the burners through the top of the burner and the bottom of the kiln. There needs to be 1/2" space between the top of the burner and the bottom of the kiln.

CONE – A ceramic composition in the shape of a pyramid about 2 ½" long (Senior or Witness Cone), which bends as a temperature is reached over a given time period. The cone is said to have reached an "end point" when its tip bends over and touches the surface upon which the cone is resting. The cone temperature is quite random with unequal temperature intervals between cones. A standard cone's composition varies according to its intended melting temperature endpoint, and thereby so does its color vary. The cone number may really only be determined by the number stamped on each cone or by testing procedures beyond the capability of the average potter. The small or Junior cone (1 1/8" h) was especially developed for the kiln sitter and should be used only in kiln sitters and not as a witness cone.

DAMPER – A cover (brick, kiln shelf, etc.) used to partially restrict the exhaust opening from the kiln. This controls the heat escaping and the fresh air entering the kiln. Proper adjustment of the damper is evidenced by continual temperature increase without increasing the gas flow to the burners. A damper also restricts air into the burner.

DOWNDRAFT KILN – A more complex system than the updraft kiln in that the exhaust as well as the intake is at the bottom. The heat may be exchanged to the ware on both its up going and down going paths. It requires a chimney or stack to induce enough draft to pull in fresh air for combustion.

FURNITURE – The shelves and posts which are used to stack ware on multiple levels while firing the kiln.

GREENWARE – Refers to any unfired ceramic ware, but usually in the dry state.

HEAT TRANSFER – Heat energy is brought into the kiln by way of the fuel. The heat is released from the fuel by combustion (burning) and is absorbed by the bricks, shelves, ware within the kiln chamber. Likewise, heat is transferred from the inside of the kiln through the brick walls, to the outside air, where it is lost for productive purposes. This is called heat loss.

HIGH LIMIT CONTROLLER – An electronic device to control kiln shutting off when a firing is finished. The kiln operator sets the target temperature, and when reached, the controller will shut the kiln down. 120 volt outlet required.

KILN SITTER – An automatic shut-off system used for bisque and glaze firings, and as a safety device when doing reduction firing.

INCHES OF WATER COLUMN – A unit of pressure: 1” of water = .577 ounces/sq. in.; 1” of water = .0631 pounds/sq. in.

ORIFICE – An opening through which gas passes into the burner. Orifice size determines the heat output of the burner; i.e., BTUs – propane due to the higher output will have a smaller orifice than natural gas.

OXIDATION FIRING – Occurs in a kiln combustion atmosphere with approximately 6% excess oxygen. This is the most common kiln firing. An electric kiln normally has an oxidation atmosphere. A gas kiln must be adjusted for this atmosphere.

PSI – Pounds per square inch. A unit of pressure.

PYROMETER – An instrument that enables accurate temperature monitoring during the kiln’s firing.

RAKU FIRING – Raku, a Japanese word often interpreted as “enjoyment” or “happiness” is a form of ceramic art in which a piece is subjected to a post-fire reduction process using sawdust, paper or other materials to change its color and chemistry. Raku artists value the technique for its ability to produce a wide range of colors and effects – since no two pieces of raku pottery ever look alike.

REDUCTION FIRING – Occurs when the air supply is restricted to an amount below that needed for complete combustion of the gas present, resulting in a consumption of oxygen from the clay and glaze compounds. Reduction produces colors based upon the metallic compounds in the clay and glazes rather than the oxides of these metallic compounds.

REFRACTORY – Materials which will withstand high temperatures, and includes fireclay products, firebrick, shelves, and posts.

SOAKING – The process of bringing a glaze to maturity, i.e., a cone end point, and holding it at that temperature to allow the bubbling and pinholes, which are a natural part of the glaze process, to heal over and become smooth. Soaking is also used for crystal growth. Proper time determined through experimentation.

SOLENOID GAS VALVE – An on-off gas valve, which is electrically operated.

THERM – A heat energy unit being used by gas companies because the cubic ft. per hr. measure does not properly describe energy usage. 1 Therm = 100,000 BTU.

THERMOCOUPLE(S) – Two types of thermocouple may be used when firing a gas kiln. The first type is the one used with a pyrometer or electronic wall unit. The second type of thermocouple is for the magnetic base valve on a gas kiln. This thermocouple senses the temperature and flame from the pilot light and causes the magnetic base valve to open when the kiln is firing and is used as a safety device to shut down the kiln when there is no flame on the pilot.

UPDRAFT KILN – A gas kiln that introduces heat at the bottom and exhausts at the top. It does not require a chimney to induce a draft. The heat is exchanged to ware while passing from bottom to top.

WALL UNIT – An electronic controller which runs the kiln firing after manual adjustments.

UL Gas Approved

The following information provides UL listing for Olympic gas kilns' components.

There is not an AGA approving statute, so we have been forced to rely on component recognition for local approval.

The High Limit Controller, when used, is manufactured by the Bartlett Instruments Company and bears UL's Universal File Number E37370 and is so marked on each board.

The wall unit electronic controller, when used, is manufactured by Bartlett Instrument Company and bears UL's Universal File Number E37370 and is so marked on each board.

Transformer:	Signal Trans., P604800 – UL Recognized
Relay:	Potterbrumfield, T92P7022-12 – UL Listed
Plug:	Leviton – UL Listed
Cord:	American Insulated Wire 12-3 SJ – UL Listed
Single Receptacle:	15A – 120V – UL Listed
Magnetic Valve:	Johnson Controls, H15DA – 10 – AGA, CSA, ANSZ 21.20
Gas Thermocouple:	Johnson Controls, Penn Baso Thermocouple Model K24BT – AGA, ANS Approved
Electric Valve:	Johnson Controls, Series H91 Basotrol – AGA, ANA, CSA Approved
Thermocouple:	Pyromation, 1K1CMG6ZZX – 12ZPHA Type K

This combination has worked successfully for many years and has been approved on its merits throughout the world.

UPDRAFT GAS KILNS Specifications

Olympic Torchbearer & Raku UpDraft Gas Kilns Specifications

Model	BTU/HR	Max Temp/Cone	Gas	Orifice Size	Number of Burners	Inside Diameter of Gas Pipeline
18 Raku	120,000	2350°F/1288°C Cone 10	Propane	1/8	2	3/4"
			Natural	3/32		
1827G	120,000	2350°F/1288°C Cone 10	Propane	1/8	2	3/4"
			Natural	3/32		
23 Raku	240,000	2350°F/1288°C Cone 10	Propane	#40	3	3/4"
			Natural	9/64		
2327G	240,000	2350°F/1288°C Cone 10	Propane	#40	3	3/4"
			Natural	9/64		
2331G	240,000	2350°F/1288°C Cone 10	Propane	#40	3	3/4"
			Natural	9/64		
28 Raku	280,000	2350°F/1288°C Cone 10	Propane	#40	4	3/4"
			Natural	9/64		
2827G	280,000	2350°F/1288°C Cone 10	Propane	#40	4	3/4"
			Natural	9/64		
2831G	280,000	2350°F/1288°C Cone 10	Propane	#40	4	3/4"
			Natural	9/64		

Model & Serial Number (SN) Identification

The serial tag is a hard silver plate with black type and is set on the front of the kiln.



The serial tag provides the model number and SN (serial number). These are critical for identifying your kiln when you need assistance. The BTU per hour are included with the maximum firing temperature. The gas type will be either LP (propane) or NG (natural gas). The orifice size used in the model is also on the tag.

LOCATING UpDraft Gas Kilns



1. Adequate space – at least 12 inches of space between the kiln and the wall. All flammable materials such as curtains, plastics, etc. in the area of the kiln should be removed.
2. Proper ventilation – if the kiln is located in a confined area it is essential that an exhaust hood be placed above the kiln and vented to the outside. This ensures removal of heat and exhaust gases including carbon monoxide. Even if the kiln is outside be sure that the hot exhaust gases do not cause damage.
3. A 120-volt outlet will be needed if the kiln sitter system or electronic wall units were purchased with the kiln.
4. A ¾” inside diameter gas pipeline is required for Torchbearers and Rakus; however, if the kiln is a long distance from the gas source, a 1” gas pipeline may be necessary.
5. If the kiln is to be placed outside make sure it does not get wet. Use a roof over the kiln or some type of water resistant tarp when the kiln is not being fired.
6. Because all kilns generate heat, the burner system, stand or frame, should be placed on a cement floor. It is important that the kiln be fired only on the metal stand or frame provided with the burner system. The eleven- (11) inch height of the stand/ frame is necessary for proper burner positioning and adequate cooling beneath the kiln. Use sheet metal or non-flammable material to shim the legs when leveling the kiln.



GAS USAGE Olympic Torchbearer & Raku Kilns

- LOW PRESSURE REGULATOR must be used for Torchbearer and Raku firing with propane. It varies for kilns firing natural gas. Low pressure regulators can be purchased from Olympic Kilns or your gas supplier.
- PROPANE – 11” Water Column
- NATURAL GAS – 7” Water Column

Olympic gas kiln burners are factory set for use on either propane or natural gas, determined by the customer’s order.

• PROPANE

If propane is used, your tank must have a low-pressure regulator like those on a camper or trailer. If an adjustable regulator is used, approximately ½ pound of pressure is necessary.

The gas pipeline needs to be a hard line with a ¾” inside diameter. The line should run 20 – 40 ft. long from the propane tank.

The larger the tank the better; however, a five (5) gallon tank is the minimum size for the 1827G or 18 Raku and a 15 gallon tank is the minimum size for the 2327G/23 Raku and 2827G/28 Raku kilns. Due to gas flow, the propane tank may have a tendency to freeze solid. If ice is observed forming on the outside of the tank, water can be run over it to help keep it melted. The tank can also be lowered into a large bucket of warm water.

When portable tanks are used for raku, keep gas tanks at a safe distance from the kiln.

• NATURAL GAS

A larger burner orifice is necessary when used on natural gas pressure, six (6) to eight (8) inches of water column is required. If your kiln was ordered for use on household natural gas, it is equipped this way.

The natural gas pipeline that connects to the kiln needs to be one that has a ¾” inside diameter.



Low Pressure Regulator

ASSEMBLY of Torchbearer Gas Kilns

(Raku gas kilns are shipped fully assembled.)

Olympic Torchbearer kilns are built in rings and may be detached and reattached when moving from one location to another. When handling your new kiln rings, always be sure to grasp the rings by the outer surface only.

Do not grasp the bricks as they are made of a porous material and may chip in your hand.

After making certain the stand is level, adjust the burner manifold so the pipe section on top of each air mixer is approximately $\frac{1}{2}$ inch below the bottom of the kiln. The kiln bottom must be positioned on the stand so each burner is directly beneath one of the holes.



The kiln rings may now be stacked with the hose clamps in back the observation holes aligned in front. If the kiln has the optional ignition system with safety shut-off, the thermocouple needs to be placed directly over the pilot. Once the kiln is assembled, be sure the inside is clean and free of dust. It may be necessary to vacuum the inside of the kiln at regular intervals.

There needs to be a half inch ($\frac{1}{2}$ ") between the burner and the bottom of the kiln floor.



ASSEMBLY of Torchbearer Gas Kilns



Inside a Torchbearer 1827G with bottom lined up correctly over gas burners

VENTING Torchbearer & Raku Gas Kilns

Proper ventilation is required when firing a gas kiln. Gas kilns fired outside may not require a vent. When purchasing a vent it is often best to choose a local HVAC or sheet metal manufacturer to provide metal for the vent, or Olympic Kilns can build one for you. If you choose to create your own vent, contact a heating and cooling supply manufacturer for purchasing a piece of sheet metal. Vent dimensions need to be either round or square in a cone shape and the bottom of the vent needs to be larger than the outside diameter of the kiln. The diameter at the top of the vent need to be 10". Vent hood will attach to a double walled exhaust pipe with 10" coupling. The double walled exhaust pipe is required by building conditions or local codes unless otherwise stated.

The vent needs to be placed 18" above the kiln when the lid is open or above the kiln frame.



OPERATION of UpDraft Gas Kilns

Once the kiln is hooked to a gas source, each burner may be ignited with a fire stick and the primary air adjusted for each of the air mixers or burners. Before attempting to adjust burners, loosen the locking screw. The locking screw need not be retightened unless the kiln is moved.

Air adjustment is accomplished by revolving the adjustment shutter plate up or down below the air mixer. The recommended starting point for natural gas is 1/4" and for propane 3/8" – 1/2".

The air adjusting plate is locked between the burner orifice and the burner. To move this plate the burner must be loosened slightly from the brass orifice which threads into the center of the burner. Air adjustment is very important and should be accomplished with care. After loosening the locking screw and the burner from the orifice, rotate each plate to insure it will move freely. Next position each air adjustment plate so the air inlets are 50% open. The kiln may be ignited while fine air adjustments are being made.

A properly adjusted kiln will have all flames uniform in appearance with transition from candle flame to intense flame occurring at the same time for each burner as the gas valve is opened. The kiln operates most efficiently when the intense flame has a bright blue color. Propane gas will not generate as intense blue color flame as natural gas. If the flame tends to blow out when the gas valve is opened the air inlet should be closed slightly.

The air adjustment of the burners need not be changed once the optimum settings are obtained; however, reduction firing in the kiln may be accomplished by closing the air inlets. The easiest and most reproducible reduction is obtained by placing a damper (kiln brick, kiln shelf) over the vent hole in the lid.

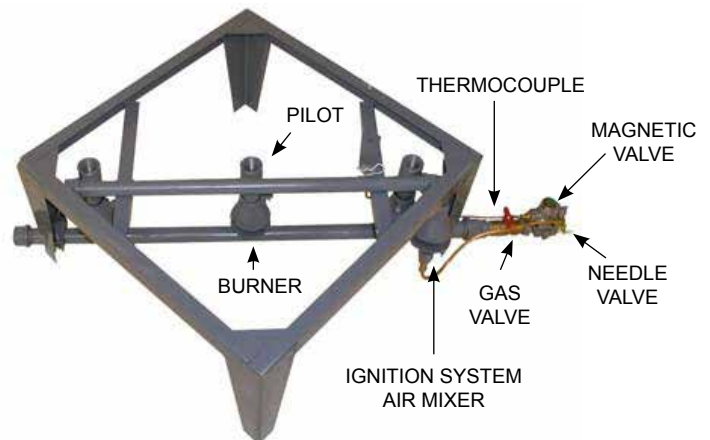

The ignition air mixer controls the amount of air that goes into each burner.

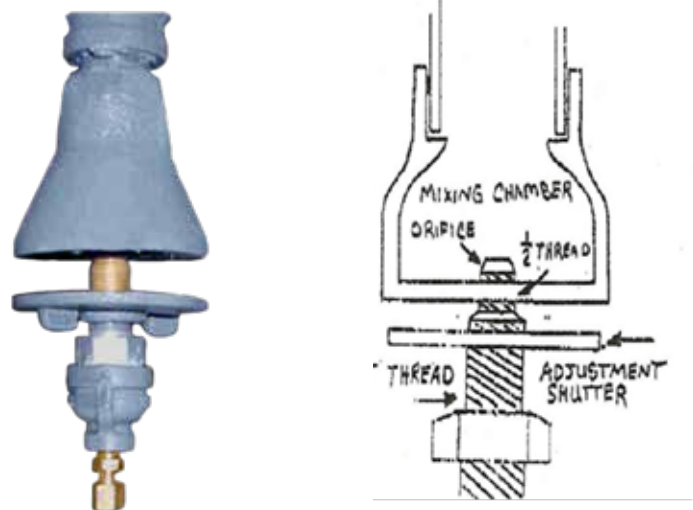

LIGHTING Torchbearer and Raku Gas Kilns

with Ignition System Installed

MAGNETIC VALVE AND THERMOCOUPLE SAFETY SHUT-OFF

The ignition system is used to:

1. Light the multiple burner system from one point
2. Maintain the flame on each burner
3. Re-ignite any burner that may extinguish

The thermocouple safety shut-off is used to stop the gas flow if the flame is lost entirely by the kiln, preventing an unused gas build up.

OPERATING THE IGNITION SYSTEM & THERMOCOUPLE SAFETY SHUT-OFF

1. Turn on the gas supply.
2. Depress the red button on the top of the magnetic valve for approximately 45 seconds.
3. Using a fire stick, light the pilot bar or ring.
4. The needle valve should be adjusted to allow sufficient gas flow to propagate a flame entirely along the pilot when it is ignited at any point.
5. Once the pilot is ignited continue to hold the button until the thermocouple sensor is hot and the valve will stay open by itself
6. Turning the gas hand valve on the burner manifold lights the burners.



OPERATION OPTIONS of UpDraft Gas Kilns

PYROMETER OPERATION

The first option is to use witness cones and an analog or digital pyrometer. Using a pyrometer requires the kiln operator to be with the kiln during the entire firing process. Analog or Digital pyrometers display a kiln's inside temperature but do not have any control over how the kiln fires or have the capability of turning the kiln off. The pyrometer is not installed directly on the gas kiln but needs to hang on a wall nearby.

OPERATION OPTIONS for UpDraft Gas Kilns

Olympic Torchbearer and Raku gas kilns have an exposed area on the stainless-steel skin usually positioned in the rear of the center of the kiln where the thermocouple of the pyrometer will be inserted. The thermocouple only needs to be inserted into the kiln about 1 ½". If hole is not pre-drilled use a ½" drill bit to create hole.

Hang wall mount pyrometer away from the kiln to prevent damage to the instrument. The lead wire from the instrument to the thermocouple is 6 feet. If calibration of an analog pyrometer is required, adjust the set screw located on the plate of the instrument with a screwdriver.



Analog Pyrometer



Digital Pyrometer



Exposed area in stainless steel jacket



The Analog and Digital Pyrometers are equipped with a Type K thermocouple which is used to indicate temperature in the gas kilns. Pyrometers equipped with a 5-6" thermocouple are used in Raku & Torchbearer gas kilns. Digital Pyrometers run on a 9 volt battery which is included with purchase.

OPERATION OPTIONS for UpDraft Gas Kilns

KILN SITTER WITH TIMER OPERATION

A kiln sitter may be ordered with your Torchbearer gas kiln or added later. If the kiln is installed with a kiln sitter, the kiln sitter electrical box on the kiln plugs into a standard 120-volt outlet. The electric valve plugs into the receptacle on the kiln sitter box.

Gas kiln sitter systems may be retrofitted after the purchase of the kiln. To add a kiln sitter to a Torchbearer kiln, drill a 1" hole in the exposed brick area of the kiln for the kiln sitter tube assembly to go through. Mount the kiln sitter electrical box to the kiln and secure to the kiln body with #6 sheet metal screws. Screw the electric valve to burner manifold, paying attention to the gas flow direction embossed on the valve.

The kiln sitter with timer is a mechanical device that will shut the kiln down once it reaches temperature. Pyrometric cones are inserted into the kiln sitter's cone supports and once the kiln reaches temperature the cone will bend and mechanically shut down the kiln. The timer is usually set 30 minutes beyond the estimated firing time and will shut down the kiln if the cone in the kiln sitter does not.

During the firing the kiln operator will open the gas valve in 45 minute increments from low to medium to high to reach the desired temperature.

When firing a gas kiln with a kiln sitter it is a good idea to have a pyrometer to know the temperature inside the kiln and witness cones on shelves to determine accurate firings.

Kiln Sitter manuals come with the kiln sitter.



Electric Valve for Kiln Sitter Operation



HIGH LIMIT CONTROLLER OPERATION

The High Limit Controller provides a digital reading of the temperature during the firing and shuts the kiln off at a preset temperature. The controller is wall mounted and requires 120 volt outlet. The controller may be retrofitted after purchase of an Olympic Torchbearer or Raku gas kiln.



OPERATION OPTIONS for UpDraft Gas Kilns

ELECTRONIC WALL UNIT OPERATION

Torchbearer or Raku kilns must have an ignition system to equip kiln with an electronic wall unit controller .

Installation of Wall Unit

1. Attach wall mount control vertically to wall.
2. Plug electric valve from the gas kiln ignition system into the wall unit.
3. Plug wall unit into power source.
4. Drill a 5/16" hole through the kiln wall and insert thermocouple from wall unit into the kiln.
5. Install the electric valve in position as shown in picture on page 21.

Olympic's Electronic Wall Units feature programming by cone number or segment method allowing the kiln operator to create their own programs. Each program has eight segments with ramp/hold profiles and controlled cooling rate. The controller features diagnostic error codes and convenient program review in addition to numerous other options.

The wall unit will operate the gas kiln but it is still a manual process until the kiln reaches a certain temperature.

The kiln equipped with a wall unit will come with an operating manual. Read the manual thoroughly and follow programming instructions that best suit your firing requirements.

When you are ready to fire the kiln, follow the instructions for operating the ignition system.

1. Depress the magnetic valve
2. Light the pilot bar
3. Release button after 45-60 seconds

Turn wall unit on and press Start. Slowly begin operating the gas valve. As the temperature increases within the kiln, continue to open gas valve as needed. You will program the electronic controller to fire on cone method or vary fire method and enter Start.

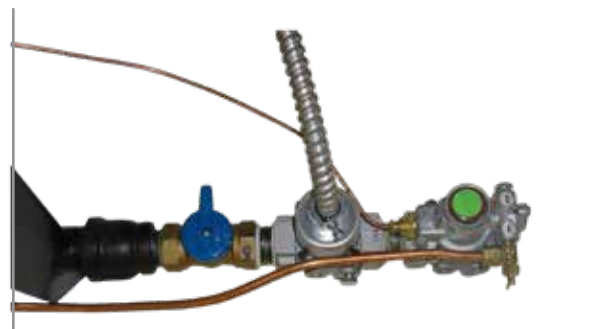

Electric Valve for
Electronic Wall Unit Operation

Olympic's electronic controller on its gas kilns requires that the operator manually manipulate the gas valve while the controller runs the kiln. Because the electronic controller runs on an on/off mode, the gas kiln operator will need to adjust the gas flow before the electronic controller will take over the firing.

You will need to manually adjust the gas valve in three 30-minute increments once the kiln begins firing.

- Adjust gas valve to have the gas fire to 500° F.
- Make a second adjustment with the gas valve to fire the kiln to 1000° F.
- The third adjustment of the gas valve will have the kiln firing at 1500° F. Once the kiln reaches 1500°F, the electronic controller will take over the firing schedule and shut the kiln off when the program is completed.

Attention: If you attempt to fire the kiln at 1500° F without making a step-by-step adjustment, you will either do damage to your ware or cause the kiln to shut down by putting too much gas into the kiln at too rapid of a rate.

Torchbearer and Raku kilns purchased without an electronic wall unit may be retrofitted after purchase if the kilns are equipped with an ignition system.

LOADING UpDraft Gas Kilns

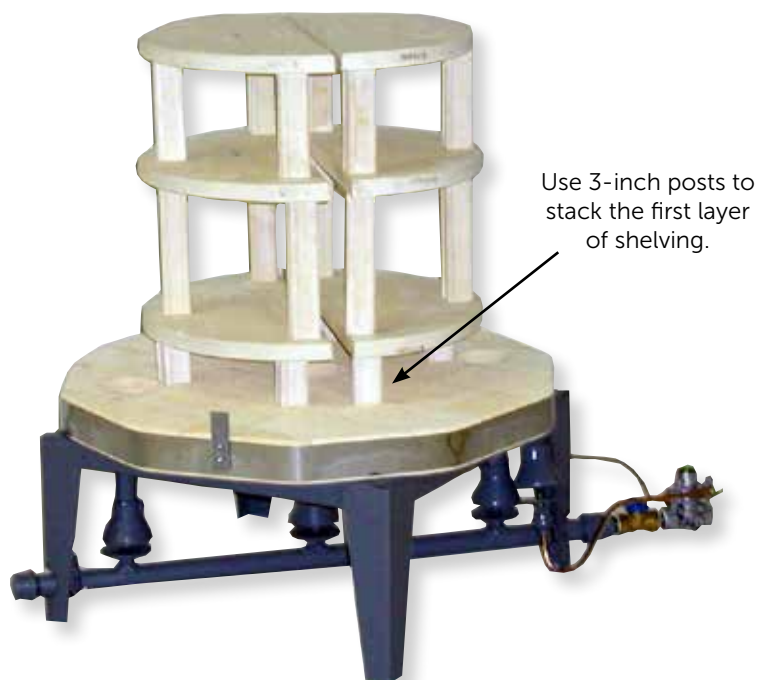

We recommend that the first layer of shelves be 3 inches above the kiln floor for proper airflow.

Shelves need a 1-inch space in the middle as you stack for proper airflow in the kiln. The direction of the shelves can be alternated from one level to another and ware can be placed on the 1-inch space between the shelves.

The top layer of shelves may be less than 1" apart.

Torchbearer and Raku 18-inch kilns have full shelves that may be used; however, the 3-inch stacking rule still applies on the first level of shelving.

Make sure the shelves are for a gas kiln. Gas shelves are smaller in diameter than electric shelves to allow for gas and air flow.

UpDraft Gas Kiln Shelves

18" Round Gas Kiln Shelves

Full Shelf – 13" Round Half Shelf – 13" x 7" Half Round

23" Round Gas Kiln Shelves

Half Shelf – 19" x 9" x 1" Half Round

28" Round Gas Kiln Shelves

Half Shelf – 24" x 12" x 1" Half Round

Make sure you use the correct size shelves for your kiln. Shelves that are too large will restrict heat and air flow.

OLYMPIC DownDraft Gas Kilns

The exhaust as well as the intake is at the bottom of the Olympic DownDraft kilns. This allows the heat to be exchanged to the ware on both its going up and going down paths. DownDraft kilns require a chimney or stack to induce enough draft to pull fresh air for combustion.



Olympic DownDraft gas kilns can be built with brick or fiber. The brick and the fiber are the same but of different consistencies. Once the fiber kiln has been fired, the fiber will harden. The fiber kiln will reach temperature faster and cool down faster than the brick kiln. If you need a slow firing and a long cool down then the brick kiln is for you.

Ceramic fiber board is installed to provide additional insulation in both Olympic brick and fiber gas kilns. On the first firing there will be residual burnout which may smell and smoke. This only occurs on the first firing.

Venturi burners can be placed on the side or underneath the DownDraft gas kiln. An optional rotating door provides easy access and maneuverability and can be ordered when the kiln is built. In addition to the front loading DownDrafts, Olympic builds DownDraft Car kilns. The car kiln includes a heavy gauge iron track for rolling the kiln floor and door in and out of the kiln chamber for easy access to ware being fired.



OLYMPIC DownDraft Gas Kilns Specifications

Model	BTU/HR	Max Temp/Cone	Gas	Orifice Size	Number of Burners	Inside Diameter of Gas Pipeline
DD9 DD9 Car	120,000	2350°F/1288°C Cone 10	Propane	#40	3	3/4"
			Natural	9/64		
DD12 DD12 Car	150,000	2350°F/1288°C Cone 10	Propane	#40	6	1"
			Natural	9/64		
DD14 DD14 Car	250,000	2350°F/1288°C Cone 10	Propane	#40	6	1"
			Natural	9/64		
DD17 DD17 Car	275,000	2350°F/1288°C Cone 10	Propane	#40	6	1"
			Natural	9/64		
DD20 DD20 Car	300,000	2350°F/1288°C Cone 10	Propane	#40	6	1"
			Natural	9/64		
DD24 DD24 Car	350,000	2350°F/1288°C Cone 10	Propane	#40	6	1"
			Natural	9/64		
DD30 DD30 Car	390,000	2350°F/1288°C Cone 10	Propane	#40	8	1"
			Natural	9/64		
DD40 DD40 Car	450,000	2350°F/1288°C Cone 10	Propane	#40	8	1"
			Natural	9/64		

Model & Serial Number (SN) Identification

The serial tag is a hard silver plate with black type and is set on the front of the kiln.



The serial tag provides the model number and SN (serial number), which are critical for identifying your kiln when you need assistance. The BTU per hour are included with the maximum firing temperature. The gas type will be either LP (propane) or NG (natural gas). The orifice size used in the model is also on the tag.

LOCATING DownDraft Gas Kilns

Four things should be considered when locating your Olympic DownDraft or DownDraft Car kiln:

1. Adequate space – at least 12 inches of space between the kiln and the wall. All flammable materials such as curtains, plastics, etc. in the area of the kiln should be removed.
2. Proper ventilation – if the kiln is located in a confined area it is essential that an exhaust hood be placed above the kiln and vented to the outside. During the firing gases from combustion, including carbon monoxide will exhaust from the top port of the kiln. Temperatures above the kiln will not be excessive and you should be able to hold your hand two feet above the kiln without discomfort; however, heat can accumulate in restricted areas above the kiln if a hood is not used.

The height of the frame of the kiln is essential for proper burner position and adequate cooling beneath the kiln. Use sheet metal or non-flammable material to shim the frame legs when leveling the kiln.

3. Convenience of electric outlets and gas sources – if you purchase the options for a gas kiln sitter system or electronic wall unit, you will need to have access to a 120-volt outlet near the kiln. Your gas pipeline needs to be approximately 40 feet from the kiln to the gas tank. Portable propane connections need to be a safe distance from the kiln.
4. If the kiln is to be placed outside, ensure that moisture is not permitted. Use a roof over the kiln or some type water resistant tarp when the kiln is not being fired.

GAS USAGE DownDraft Kilns

- PROPANE – 11” Water Column
- NATURAL GAS – 7” Water Column
- The inside diameter pipeline for the DD 9 is 3/4”. All other models - 1” inside diameter pipeline. Pipelines are purchased from your gas supplier.
- Olympic gas kiln burners are factory set for use on either propane, or natural gas from a street main.

PROPANE

If propane is used, your tank must have a low-pressure regulator like those on a camper or trailer. If an adjustable regulator is used approximately ½ pound of pressure is necessary. The table shows the minimum size tank for a cone 10 firing for each DownDraft model. You need to purchase a larger tank than the cone 10 firing requirement so that you do not have to refill the tank after each firing.

NATURAL GAS

A larger burner orifice is necessary when used on the standard gas pressure of six (6) to eight (8) inches of water column. If your kiln was ordered to fire with natural gas, it is equipped this way.

DOWNDRAFT MODEL	PROPANE (GALLONS)
DD9	10
DD12	15
DD14	18
DD17	21
DD20	24
DD24	29
DD30	40
DD40	48

ASSEMBLY of DownDraft Gas Car Kilns

Olympic DownDraft kilns are shipped ready to fire. Olympic DownDraft Car kilns will require some assembly.

If you have requested a custom order, for example, a DownDraft kiln with outside dimensions that cannot normally go through a 34 ½" door, please note: If the door must be taken off, or some other irregular situation is needed, contact Olympic Kilns before dismantling the kiln in order to maintain your warranty and to insure that damage does not occur to the kiln.

Upon receipt of your DownDraft gas kiln, after you have removed the packing, you will find your kiln completely assembled and bolted to the shipping pallet. Unbolt from pallet and move into place.

If a car kiln was ordered, the following instructions must be followed to avoid damage to your new kiln as you unpack and set up.



STEP 1 Block wood pieces strapped to the pallet beside the kiln and the track strapped to the opposite side. Remove these from the pallet and install track with blocks and bolts provided.



Place the wood under the track and bolt the track to the kiln with the kiln on the pallet. Insure that the track is both level and straight.



Extreme damage to the kiln will result if the car is not level when removed from the firing chamber.

ASSEMBLY of DownDraft Gas Car Kilns



Insure that the track is both level and straight.



ASSEMBLY of DownDraft Gas Car Kilns

STEP 2

Unlatch the door.



STEP 3

Carefully withdraw the door and car from the kiln, lift it over the ends of the rail onto the floor.



ASSEMBLY of DownDraft Gas Car Kilns

STEP 4

Detach the rail from the kiln.



STEP 5

The bolts securing the kiln to the pallet must be removed.



STEP 6

The kiln may now be lifted from the pallet.



ASSEMBLY of DownDraft Gas Car Kilns

STEP 7

When the kiln is in its permanent place, the track needs to be reinstalled and bolted to the kiln.



Bolts are on both sides of track.



STEP 8

Position the car at the end of the rails. First, lift the front of the car onto the track, and then lift the back of the car onto the track. Carefully close the kiln.



First, lift the front of the car onto the track.



Second, lift the back of the car onto the track.



VENTING DownDraft Gas Kilns

Olympic vent hoods for DownDraft gas kilns are made of 20-gauge stainless steel or galvanized steel. The vent hood is 48" x 48" and discharges into a 10" inside diameter pipe collar. It is mounted on the kiln by a frame which is welded to the kiln. A double-walled or greater exhaust pipe, 10" in diameter, needs to extend out of the top of the exhaust opening and through the wall or ceiling to the outside. Check with local codes to insure the correct exhaust pipe is used. The exhaust pipe is not included with the vent purchase.

Vent Hood ships separately from kiln and is wood crated for shipping.
57" x 55" x 30" – 200 lbs.

Vent Hood & Frame
add 39" to height of kiln

Vent Hood 48" x 48" wide x 28.5" high



OPERATING DownDraft Gas Kilns

Once the kiln is connected to a gas source, each burner may be ignited and the primary air adjusted for each of the air mixers or burners. Air plates are usually where they belong so test before adjusting.

Loosen the locking screw before attempting to adjust the burners. The locking screw need not be re-tightened unless the kiln is being moved.

Air adjustment is very important and should be accomplished with care. The air adjusting plate is locked between the burner orifice and the burner. The burner must be loosened slightly from the brass orifice, which threads into the center of the burner, to move the air adjusting plate. After loosening the locking screw and the burner from the orifice, rotate each plate to insure it will move freely. Next position each air adjusting plate so the air inlets are 50% open. The kiln may now be ignited and the fine air adjustments can be made.

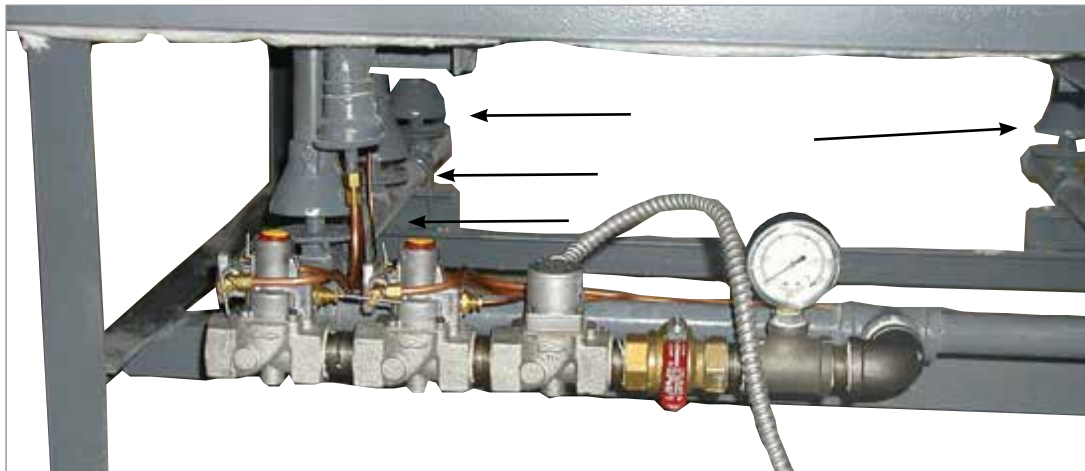

A properly adjusted kiln will have all flames uniform in appearance with the transition from candle to an intense flame occurring at the same time for each burner as the gas valve is opened. The kiln operates most efficiently when the intense flame has a bright blue color. Propane gas will not generate as intense blue color flame as natural gas. If the flame tends to blow out when the gas valve is opened the air inlet should be closed slightly.

The air adjustment of the burners need not be changed once the optimum settings are obtained; however, reduction firing in the kiln may be accomplished by closing the air inlets. The easiest and most reproducible reduction is done by using the damper at the top of the kiln.

LIGHTING DownDraft Gas Kilns

Turn on your gas supply. Olympic DownDraft kilns are designed to light the left pilot bar first and then the right pilot bar. All Olympic DownDraft kilns are equipped with an ignition system.

MAGNETIC VALVE AND THERMOCOUPLE SAFETY SHUT-OFF

The ignition system is used to:

1. Light the multiple burner system from one point
2. Maintain the flame on each burner
3. Re-ignite any burner that may extinguish

The thermocouple safety shut-off is used to stop the gas flow if the flame is lost entirely by the kiln preventing an unused gas build up.

To operate the ignition system, depress the red button on the top of the magnetic valve on the left side facing the kiln and light the ignition bar on the left side of the kiln, after 60 seconds, release the button and do the same on the right side of the kiln.

The burners are ignited by turning the hand valve on the burner manifold. Open the hand operated valve slowly until the gas begins to flow and the burners ignite from the ignition bar. Monitor the pressure gauges for firing reproducibility.

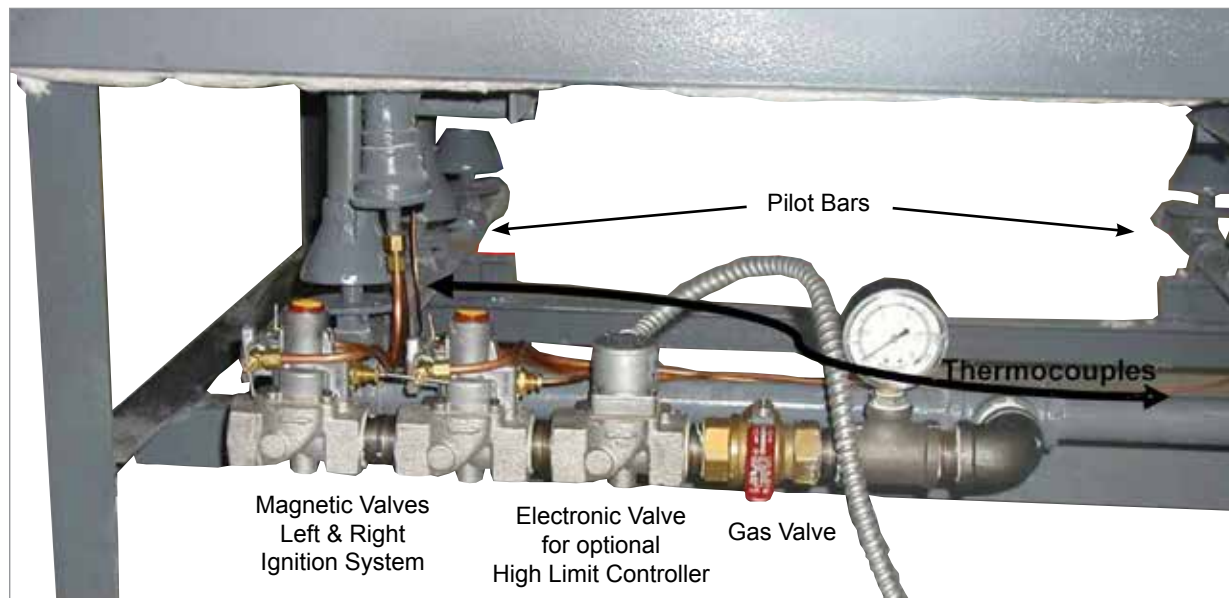

OPERATING OPTIONS for DownDraft Gas Kilns

200K Blower Burner Option

Standards & Approvals

AGA	American Gas Association
ANS	American National Standards
CGA	Canadian Gas Association
CSA	Canadian Standards Association
UL	Underwriters Laboratory

Virtually all burners are, themselves, not approved by the above agencies because they become part of systems, which are field approved by local agencies. If you have problems with compliance to local codes, feel free to contact us or have inspectors contact us. We use the finest parts available.

Component List of Olympic Kilns 200K Blower Burner

Dayton Shaded Pole Blowers: Model 4C440, 4C442, & 4C443

CSA & UL (under the motor component recognition program) File E47479 for the thermal protection, File E37403 for impedance protection and File E40077

Vari-Speed Motor Speed Control: Model KBWC13-K

UL Approved

General Controls Series MR2 BASO™ Valve

AGA, CSA, ANS Z21.20 Auto Valves

Johnson Controls Series H91 Basotrol Electric Solenoid Valve

AGA, CSA, ANS Z21.21 Auto Valves

Honeywell Pilot Burner Model Q314A

AGA, ANS Approved

Johnson Controls Penn Baso™ Thermocouple Model: K24BT

AGA, ANS Approved

Watts Gas Cock Regulator Valve, Model: ¾ Inch 0545005

AGA, CSA, UL Approved

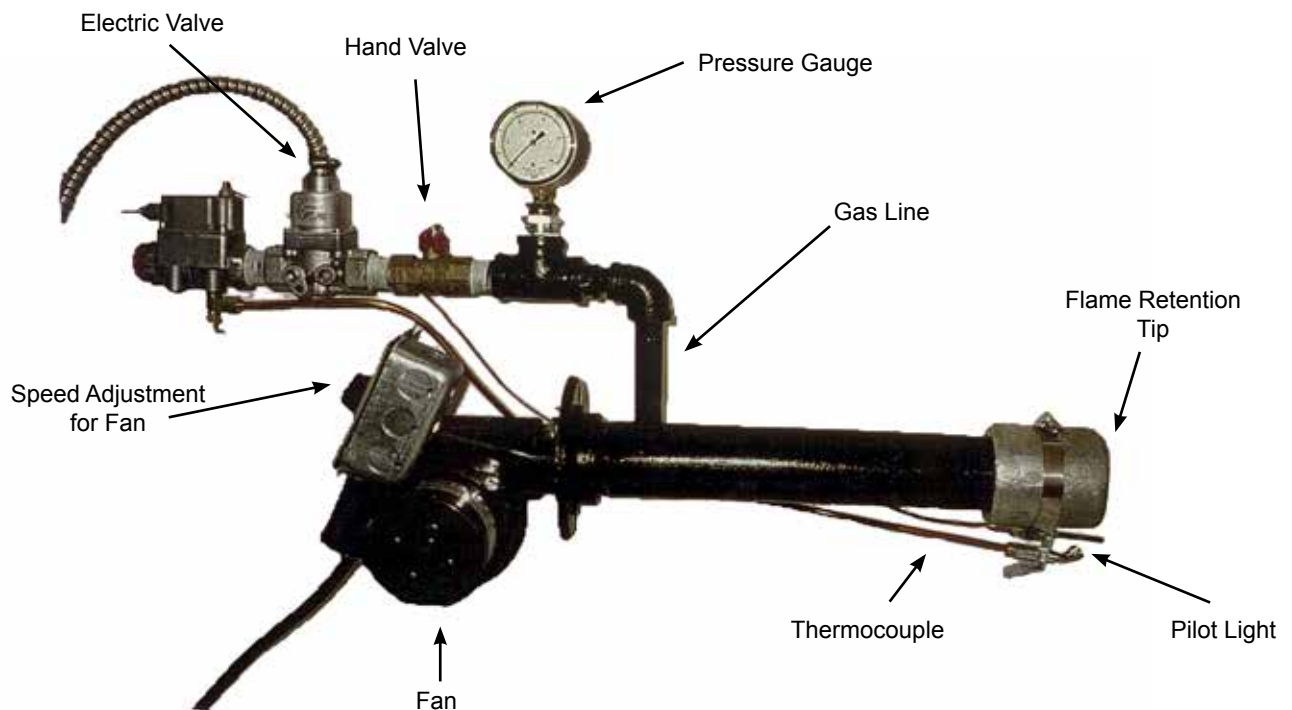

OPERATING OPTIONS for DownDraft Gas Kilns

BLOWER BURNER OPERATION

The blower burner option must be ordered at the time of purchase. The blower burner runs on a 120 volts and a 120 volt outlet is required. Forced air burners with the output of 500,000 BTUs each provide excellent temperature and reduction uniformity as an option to the venturi burners.

1. Make sure burner shutoff valve is open and the flow of control valve is closed.
2. Open needle valve to pilot burner.
3. Hold down red BASO™ reset button and light the pilot burner while continuing to hold down the button for 30-45 seconds. Release.
4. Adjust blower to a low setting.
5. Slowly open flow control valve until the main ignition occurs.
6. Increases in gas need to be accompanied by increases in air. It is easier to adjust the air, than adjust the gas to match. Due to the circuitry involved in the speed control, you may experience a lag in the air setting.
7. To turn off blowers, shut flow control valve, turn off blower, and close gas cock. Unplug after use.

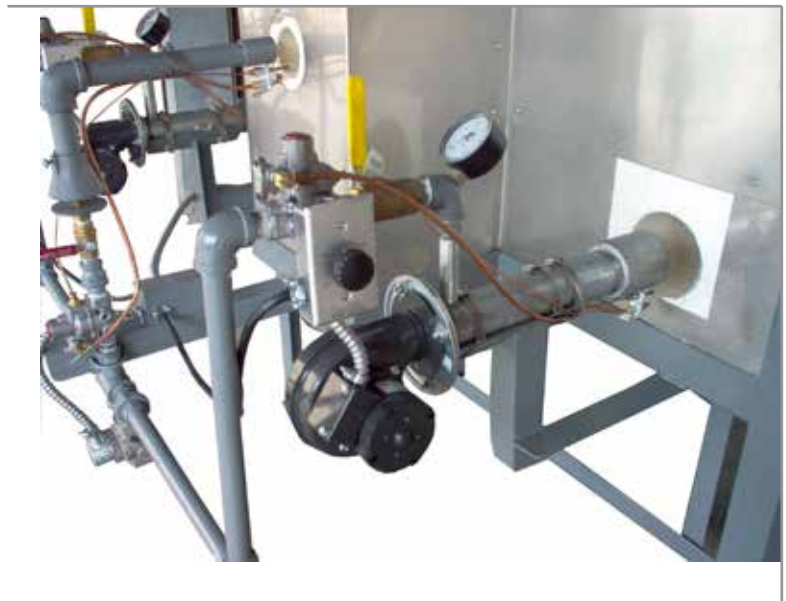

Blower Burners on DownDraft Gas Kiln

OPERATING OPTIONS for DownDraft Gas Kilns

PYROMETER OPERATION

The first option is to use witness cones and an analog or digital pyrometer. Using a pyrometer requires the kiln operator to be with the kiln during the entire firing process. Analog or Digital pyrometers display a kiln's inside temperature but do not have any control over how the kiln fires or have the capability of turning the kiln off. The pyrometer is not installed directly on the gas kiln but needs to hang on a wall nearby.

Olympic DownDraft gas kilns have an exposed area on the stainless steel skin usually positioned in the rear of the center of the kiln where the thermocouple of the pyrometer will be inserted. The thermocouple only needs to be inserted into the kiln about 1 1/2". If hole is not pre-drilled, use a 1/2" drill bit to create hole.

Hang wall mount pyrometer away from the kiln to prevent damage to the instrument. The lead wire from the instrument to the thermocouple is 6 feet. If calibration of an analog pyrometer is required, adjust the set screw located on the plate of the instrument with a screwdriver.



Analog Pyrometer



Set screw



Digital Pyrometer



Exposed brick area on DownDraft gas kiln

The Analog and Digital Pyrometers are equipped with a 10" Type K thermocouple which is used to indicate temperature in the gas kilns. Digital Pyrometers run on a 9 volt battery which is included with purchase.

OPERATING OPTIONS for DownDraft Gas Kilns

KILN SITTER WITH TIMER OPERATION

A kiln sitter may be ordered with your DownDraft gas kiln or added later. If the kiln is installed with a kiln sitter, the kiln sitter electrical box on the kiln plugs into a standard 120-volt outlet. The electric valve plugs into the receptacle on the kiln sitter box.

Gas kiln sitter systems may be retrofitted after the purchase of the kiln. To add a kiln sitter to a DownDraft kiln, drill a 1" hole in the exposed brick area of the kiln for the kiln sitter tube assembly to go through. Mount the kiln sitter electrical box to the kiln and secure to the kiln body with #6 sheet metal screws. Screw the electric valve to burner manifold, paying attention to the gas flow direction embossed on the valve.

The kiln sitter with timer is a mechanical device that will shut the kiln down once it reaches temperature. Pyrometric cones are inserted into the kiln sitter's cone supports and once the kiln reaches temperature the cone will bend and mechanically shut down the kiln. The timer is usually set 30 minutes beyond the estimated firing time and will shut down the kiln if the cone in the kiln sitter does not.

During the firing the kiln operator will operate the gas valve in 45 minute increments from low to medium to high to reach the desired temperature.

When firing a gas kiln with kiln sitter it is a good idea to have a pyrometer to know the temperature inside the kiln and witness cones on shelves to determine accurate firings.

Kiln Sitter manuals come with the kiln sitter.

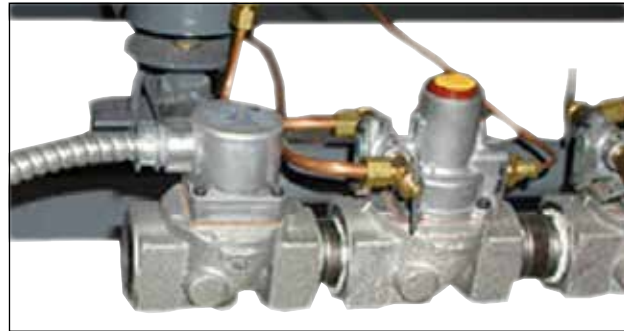

Electric valve for Kiln Sitter on DownDraft gas kiln

HIGH LIMIT CONTROLLER OPERATION

The High Limit Controller provides a digital reading of the temperature during the firing and shuts the kiln off at a preset temperature. A 120 volt outlet is required and the controller may be retrofitted after purchase to an Olympic DownDraft gas kiln. Operating manual comes with the High Limit Controller.



ELECTRONIC WALL UNIT INSTALLATION

1. Attach wall mount control vertically to wall.
2. Plug electric valve from the gas kiln ignition system into the wall unit.
3. Plug wall unit into power source.
4. Drill a 5/16" hole through the kiln wall and insert thermocouple from wall unit into the kiln.
5. Install the electric valve in position as shown in picture on page 41.



Olympic's Electronic Wall Units feature programming by cone number or segment method, allowing the kiln operator to create their own programs. Each program has eight segments with ramp/hold profiles and controlled cooling rate. The controller features diagnostic error codes and convenient program review in addition to numerous other options.

The wall unit will operate the gas kiln but it is still a manual process until the kiln reaches a certain temperature.

DownDraft kilns equipped with a wall unit will come with an operating manual. Read the manual thoroughly and follow programming instructions that best suit your firing requirements.

OPERATING OPTIONS for DownDraft Gas Kilns

ELECTRONIC OPTIONS OPERATION

If any electronic option equips the kiln, you must activate the electronic option in order to activate the gas and air.

1. Plug kiln sitter, electronic high limit control, electronic wall unit into 120-volt outlet.
2. Set kiln sitter and timer with cone and activate, set high limit control to desired end temperature or enter program for wall unit and start.
3. Turn control on and electric gas valve will open.
4. Turn on gas for the burner pilots (small brass valves).
5. Depress red button on the left side magnetic valve and light pilot with torch, then do the same for the right side magnetic valve.
6. Hold red button down approximately 15 seconds after lighting pilots.
7. Open hand operated valve slowly until the gas begins to flow and the burners ignite from the ignition bar.
8. Monitor the pressure gauges for firing reproducibility.

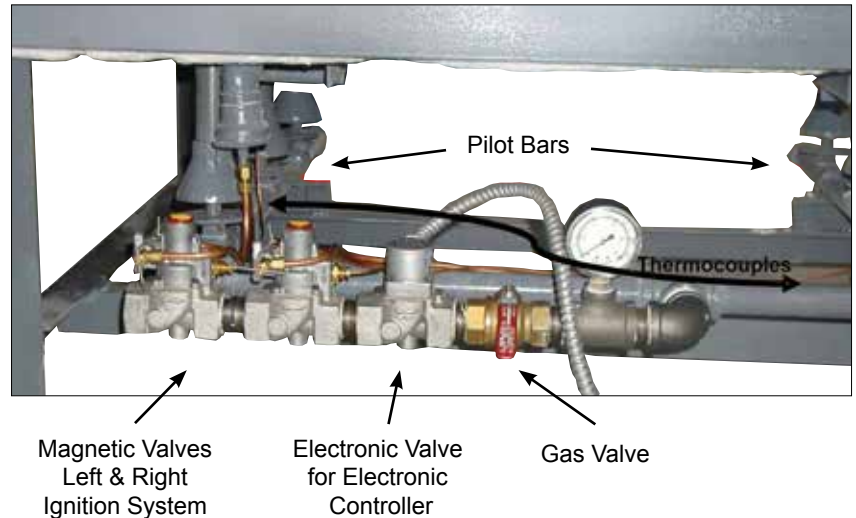

ELECTRONIC WALL UNIT OPTION OPERATION

Turn wall unit on and press Start. Slowly begin operating the gas valve. As the temperature increases within the kiln, continue to open gas valve as needed.

Olympic's electronic controller on its gas kilns requires that the operator manually manipulate the gas valve while the controller runs the kiln. Because the electronic controller runs on an on/off mode, the gas kiln operator will need to adjust the gas flow before the electronic controller will take over the firing. You will program the electronic controller to fire on cone method or vary fire method and enter Start.

You will need to manually adjust the gas valve in three 30-minute increments once the kiln begins firing.

- Adjust gas valve to have the gas fire to 500°F.
- Make a second adjustment with the gas valve to fire the kiln to 1000°F.
- The third adjustment of the gas valve will have the kiln firing at 1500°F. Once the kiln reaches 1500°F, the electronic controller will take over the firing schedule and shut the kiln off when the program is completed.

Attention: If you attempt to fire the kiln at 1500° F without making a step-by-step adjustment, you will either do damage to your ware or cause the kiln to shut down by causing too much gas into the kiln at too rapid rate.

LOADING DownDraft Gas Kilns

Kiln shelves need a 1-inch space in the middle as you stack for proper airflow in the kiln. You may switch direction of the shelves and place ware on the 1-inch space but you need the 1-inch space between shelves.

The first layer of shelves needs to be placed on 3-inch posts for proper airflow.

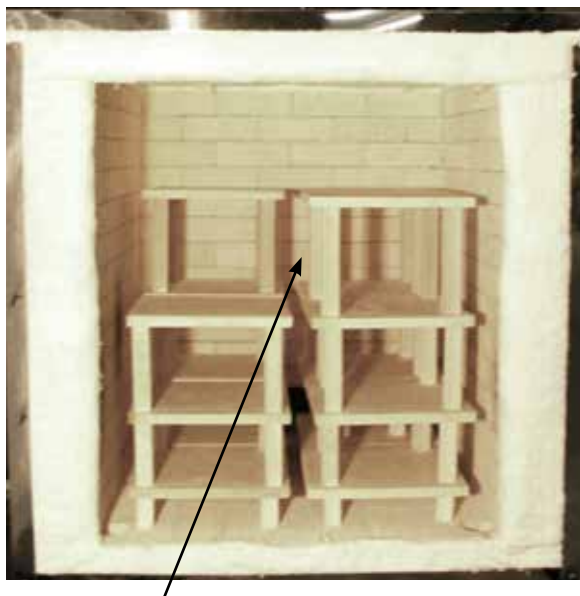

Space kiln shelves one (1) inch apart.



Ware can be loaded across the 1-inch space.

DOWNDRAFT GAS KILN SHELF SIZES

DD9	Rectangle 11" x 22" x 1"	2 per layer
DD12	Rectangle 13" x 26" x 1"	2 per layer
DD14	Rectangle 14" x 28" x 1"	2 per layer
DD17	Rectangle 14" x 28" x 1"	2 per layer
DD20	Square 15" x 15" x 1"	4 per layer
DD24	Square 16" x 16" x 1"	4 per layer
DD30	Square 18" x 18" x 1"	4 per layer
DD40	Square 20" x 20" x 1"	4 per layer

Make sure you use the correct size shelves for your kiln. Shelves too large will restrict heat and air flow.

FIRING Schedules – Examples

The following firing schedules are recommendations and should be considered a starting point for the method eventually adopted by the user of the kiln. Each kiln has its own individual characteristics that may be influenced by location, gas pressure, gas flow, weather, and the potter's own individuality. The user of a gas kiln needs to be willing to experiment with different firing techniques in an effort to express his/her own theories and develop methods which prove most satisfactory for the user's own unique situation.

All firing schedules need to be adjusted to conform to the thickness and mass of the ware being fired and the load density of the kiln. The more pieces the kiln contains, the slower it should be fired. Finally, the clay body must be considered, remembering its strength, reaction to thermal shock, dryness, etc. Examples of firing schedules should be taken as that – examples only.

CONE FIRING RATE – RECOMMENDED BY THE ORTON CERAMIC FOUNDATION²

Rate of Temperature Increase	60°C/hr 140°F/hr	150°C/hr 300°F/hr	300°C/hr 570°F/hr
Firing To	<i>Elapsed Time to Cone End Point</i>		
Cone 4	17 hrs	7 hrs	3.5 hrs
Cone 5	19.7 hrs	8 hrs	4 hrs
Cone 10	21.4 hrs	8.7 hrs	4.4 hrs

These are the firing rates specified by the Orton Ceramic Foundation and followed by the National Business of Standards (NBS) to reach the specified end point temperature.

BISQUE FIRING

Dry the newly formed ware at room temperature until it is no longer cold to your sense of touch. Smaller pieces need seven to ten days drying time and larger pieces 10 to 15 days. Bisque or pre-firing is necessary to pre-condition the ware for glaze application and glaze firing. Bisque firing is a slow firing in which the physical and chemical water is driven off and the body becomes hard and solid. The ware is most susceptible to cracking during the early stages of bisque firing and several temperature zones should be crossed with extreme care.

The physical water leaves the clay at 212° Fahrenheit and the chemical water is driven off from 350° to 500° Fahrenheit. At 1073° Fahrenheit the quartz inversion occurs causing a size change in the body of approximately 2%.

To Bisque

1. Ignite the burners and adjust the gas valve to allow the flame to burn with a candle flame for 30 minutes. (Sometimes only the ignition system is needed for candle process.) The pre-heating period should be extended if thick walled pieces are being fired or the kiln is densely loaded. Some soot may be observed during the candling period; however, it will burn out when the kiln reaches higher temperatures.
2. Open the gas valve enough to increase the length of the candle flame and cover the top port about 80%. Leave the kiln in this condition approximately one (1) hour.
3. Turn up the gas to allow the flame to burn with more force and with a little yellow color. Open the top port about half way. After several hours at this rate open the gas valve half way. Leave the kiln at this rate for two hours or until the inside coloration is a dull red.
4. After the ware has passed through its critical point, which is indicated, by the dull red coloration, the burners can be turned up all the way and the top port can be completely opened.
5. When (you have reached the desired temperature indicated by witness cone, pyrometer reading, electric control completion or kiln) sitter has shut-off; cover the top port and plug the observation holes.

FIRING Schedules – Examples

BISQUE & SCULPTURE FIRING SCHEDULE EXAMPLES³

Candle (Pre-heat) – Below 212°F All Night

Bisque Firing

150°F/hr to 600°F Check & Log Every 30 Minutes
250°F/hr to 1100°F Check & Log Every 60 Minutes
300°F/hr to Completion Check & Log Every 60 Minutes
Within 100°F of End Point Check & Log Every 10 Minutes

Sculpture Firing

100°F/hr to 600°F Check & Log Every 30 Minutes
150°F/hr to 1100°F Check & Log Every 60 Minutes
250°F/hr to Completion Check & Log Every 60 Minutes
Within 100°F of End Point Check & Log Every 10 Minutes

GLAZE FIRING

The kiln should be warmed up with a slow flame for about one (1) hour. The flame can then be gradually increased at will until it is fully on. When kiln is fully on, the top port should be completely open. After the desired temperature has been reached, leave the kiln on for at least an hour at that temperature to properly soak the ware. Shut the kiln off as before, plug the observation holes and cover the top port. For best results do not reopen the kiln for 24 hours.

GLAZE FIRING SCHEDULE EXAMPLE⁴

Glaze Firing

200°F/hr to 600°F Check & Log Every 30 Minutes
250°F/hr to 1100°F Check Every 30 Minutes & Log Every 60 Minutes
300°F/hr to Completion Check Every 30 Minutes & Log Every 60 Minutes
Within 100°F of End Point Check & Log Every 10 Minutes

CONE 10 REDUCTION

The easiest way to obtain reduction effects is to wait until the kiln is near cone 9 and then cover the top port about one (1) inch. Wait for 30 seconds and watch for a slight flame coming from the top port and observation holes. If no flame is seen, cover another ½ inch and wait for the flame. Keep doing this in small increments until a slight flame is seen. Leave the kiln in this condition for about one hour then take the top port cover off completely and bring to final temperature. It is important to remember that over reduction will drop the inside temperature considerably and waste both gas and time.

When firing with propane the flame is always evident at the top port. Turn the gas down a little if less flame is desired.

Body reduction may be accomplished by heating the kiln to cone 05 with top port open. At cone 06 cover the top port with the brick provided until the flame is evident from the top port and observation holes. The reducing atmosphere should be maintained for 30 minutes then the brick covering the top port should be pulled back until only an occasional flick of flame is seen from the observation holes. The kiln can then be heated to cone 9 and an additional reduction can be done as described above. A slightly reducing atmosphere from cone 06 to 9 will insure that the effects of the body reduction are not lost with additional heating.

FIRING Schedules – Examples

FIRING ATTENTION TO DETAILS⁵

CONDITION	BURNERS	DAMPER	AIR PORTS	TIME
Candling, especially important for bisque or large pieces	Pilots on or one burner on low	Lid or door may be kept ajar if temperature goes up too fast.	View ports left open	All night below 200°F or 2 hours per each 1/8 inch thickness of thickest pieces.
Oxidation Firing	Burners on, blue flame, clear atmosphere inside kiln.	Temperature rise is a combination of damper and gas pressure settings.	Admit amount of air needed to get blue flame.	200°F per hour to 1290°F
Reduction Firing	Tip of flame shows yellow and orange.	Damper will probably have to be closed some to maintain temperature rise.	Close air ports to get flame color. Flame should shoot out of view ports.	Begin reducing after kiln has reached 1290°F.

Body Reduction @ Cone 06

Glaze Reduction @ Cone 8-10

FORCED AIR BURNER VS VENTURI BURNER REDUCTION TIPS

Forced air burners offer more control than Venturi burners when it comes to the air/gas ratio. This can cause confusion if you are not used to force air systems. Venturi burners pull the air they need into themselves. They will not pull more than they need, but can be made to pull less than they need. When you want to reduce with Venturis, you close down the primary air spin plate and push the damper some.

Since you have more control over the air with Blower Burners, you can reduce as well as spill excess air into the kiln. Excess air cools the flame and can be as wasteful as over reduction. Spilling excess air re-oxidates the ware by providing extra oxygen that would not otherwise be present. The tightest small blue flame you can produce is most likely a cool, excess air flame. To get a good air/gas ratio flame, look for the earliest signs of reduction such as a “swirly” atmosphere, then clean up the flame by increasing the air or decreasing the gas. When the flame first starts to clean up by becoming tighter and a little louder, your ratio is becoming correct.

To reduce with your Blower Burner you can increase the gas while leaving the air constant, or decrease the air and leave the gas constant. Increasing the gas will tend to keep the kiln from stalling as much as if you decreased the air. If you want your reduction climb to go slowly, you may want to decrease the air. You are going to be looking for normal reduction indicators: swirly atmosphere and short flames from top and middle observation holes. Long flames going out observation holes and flames going up the chimney are signs of over reduction and waste of gas. Your burner and its’ settings control reduction while the damper controls kiln pressure. You want to have positive pressure in the kiln at the top and middle and neutral pressure at the bottom observation hole. Remember, any new kiln or burner system takes some experimentation to understand the nuances.

REDUCTION ATMOSPHERE MAGNITUDE⁶

ATMOSPHERE	FLAMES	VIEW INTO CHAMBER	PORT OR EXHAUST
Light Reduction	Yellow tips occasionally flashing. Flame is vigorous and hot.	Tongues of yellow flame show occasionally between the ware. Atmosphere relatively clear.	Occasional spurt of flame from any opening.
Mild Reduction	Yellow & orange flames predominate. Some blue flame still present. Flame is vigorous and hot	Chamber begins to cloud. Luminous character of flame brightens interior. No loss of temperature increase rate.	Flames begin to spurt regularly from ports or vent.
Heavy Reduction	Blue flame rarely present. Flame becomes brighter and takes on a leisurely appearance. Bright from carbon but not hot.	Hard to distinguish shapes of pots in chamber. Cones probably cannot be seen. Temperature rise slows or even ceases.	Flame tips appear from every port. Occasional wisps of smoke indicates you are over doing it!
Over Reduction	No blue flame present. Flame is a quiet, leisurely, flashing orange and yellow.	Impossible to view because of flames coming from ports. Probable temperature decrease.	Smoking heavily from cracks and openings. Surfaces begin to blacken. Back off! It doesn't help a bit!

¹Ralph W. Ritchie, *Gas Firing Kilns*, p. 42

²Ralph W. Ritchie, *Gas Firing Kilns*, p. 10

³Ralph W. Ritchie, *Gas Firing Kilns*, p. 11

⁴Ralph W. Ritchie, *Gas Firing Kilns*, p. 11

⁵Ralph W. Ritchie, *Gas Firing Kilns*, p. 15

⁶Ralph W. Ritchie, *Gas Firing Kilns*, p. 17

FIRING Schedules – Examples

RAKUING

Olympic Raku Gas Kilns are built to raku, bisque, glaze and reduce.

PLANNING

Use Raku clay bodies. This clay body is able to withstand rapid heating and cooling.

Apply Raku glaze which achieves metallic effects and crackle lines.

- Make sure there is an adequate fuel supply.
- Provide reduction containers (galvanized trash can with lid) that are the correct size and arrange for easy access and clear movement around the kiln.
- Keep combustibles (newspaper, sawdust, leaves, pine needles, etc.) at a safe distance from the kiln, yet easy to reach during the post firing process.
- Train helpers.
- Arrange water sources for cooling and emergency situations.
- Provide safe, clear avenues for unencumbered movement.
- Tongs, fire-proof gloves

LIGHTING THE KILN

- Turn on the gas
- Slowly open and light each burner or if kiln has ignition system push (red) button while lighting pilot bar (bar that runs underneath the kiln) until the flame holds. After ignition system is lit, burners will light automatically.
- Slowly open gas valve (blue or red valve controls gas to burners). When the gas valve is perpendicular to the bar, gas is allowed to flow to the burners.



Analog Pyrometer

A pyrometer will greatly enhance your efforts during the raku process.

As the kiln reaches approximately 1800°F, begin loading your ware. Slowly lower the raku drum in 10-15 minute intervals to allow pottery to get used to the thermal shock until drum is completely closed.

Around 1900-1950° F, the rakuing process will begin to take place.

You can tell the ware is ready to remove by its shiny, wet appearance. Raise drum, remove pieces and place in reduction containers as quickly as possible.

Once ware is inside the container, add more reduction material and cover within 15 seconds to ensure efficient smoking. (It is not how much reduction material you use, but how fast you can get pottery into the container and covered that provides exceptional raku pieces.) Keep container covered for 15 minutes to 1 hour.

Olympic Raku kilns are designed to maintain their temperature (even when drum is lifted) so that you can continue the rakuing process without interruption. Once ware is removed from the kiln to be placed in reduction containers, new items may be loaded in the kiln. You may also want to place items on top of the raku drum (on the outside) that you will be rakuing next so that they are warmed up before placing in the kiln.

GAS KILN Maintenance

Easy Tips to Keep Your Gas Kiln Running Smoothly



Buildup of soot and dirt on the gas pipeline occurs after many firings. We recommend that you use a steel brush to clean the gas pipeline and pilot bar periodically.



You may also need to clean the orifices after a length of time because dust, rust, kiln wash flakes, and bugs can corrode operation. You can clean the orifice with ¼" plastic or rubber tubing by blowing off residue, and/or by straightening out a paper clip and inserting into the orifice and twisting the clip around in the orifice hole.



Vacuum your kiln on a regular basis to remove dust, kiln wash, etc. from kiln.



UPDRAFT GAS KILNS

Occasionally a raku kiln frame will become stiff as you try to lift the firing chamber. Simply lubricate the bars with WD40 to maintain smooth raising and lowering of the firing chamber.



Periodically tighten the hose clamps on the stainless steel bands of the Torchbearer & Raku kilns. As you load and unload ware in the kiln and as the kiln expands when heated, rings will get out of alignment with the burners. Just tighten the hose clamp with a screwdriver when the kiln is firing to keep bands tight and rings in alignment.

If you need to replace broken brick in a Torchbearer or Raku kiln: Remove the ring in the Torchbearer that needs brick repair. Loosen the stainless steel skin on the ring slightly so that you have enough space to remove the brick but not enough to dis-engaged all the brick in the ring. Replace new brick as needed and tighten the hose clamp. For Raku kilns you will need to loosen the hose clamp on the firing chamber and work within the chamber to replace the brick.

DOWNDRAFT GAS KILNS

DownDraft gas kilns have a complex design. The frames are heavy angle iron and 1-inch thick steel tubing. Brick DownDraft walls consist of 4 ½" thick mortared brick and 1" thick ceramic fiberboard and fiber DownDraft walls are 4 inches thick consisting of 3" fiber and 1" thick ceramic fiberboard. The floors in the fiber and brick DownDrafts are built with double insulated floors made of mortared brick and ceramic fiberboard. If the walls or floors become damaged contact Olympic Kilns with the model and serial numbers for replacement parts.

If damage occurs to the door or the roof, the pyro block can be replaced. Pyro blocks are mounted on threaded stud that bolt into the frame of the kiln.

KILN FURNITURE

Always use kiln wash on kin shelves when glaze firing. When kiln shelves are not in use, stand shelves for longer life. Do not lay flat or stack on top of one another.



TROUBLESHOOTING

Pilot Bar or Ring will not light.

1. Ignition system lights but the burners aren't lighting the gas pressure is too high. Kilns firing on propane require 11-inches water column pressure and natural gas fired kilns run on 7-inches water column pressure.
2. If the ignition system will not light then there's not any gas coming to it. Check to see if the gas is turned on.
3. If the ignition system lights but won't stay lit, the thermocouple is not in the correct position. See page 45. Reposition thermocouple. If the thermocouple is in the correct position then the base valve needs replacing.

Kiln is not reaching temperature.

Failure to reach temperature is either too much or too little gas. Too much gas is identified by excessive flame discharge. Too little gas is probably from a small gas line. Your kiln should have a regulator of 11 inches water column for propane and 7 inches water column for natural gas with a 3/4" inside diameter pipe for updraft gas kilns and 1" inside diameter pipe for DownDraft gas kilns between the kiln and regulator. Have the air adjustments wide open for propane.

Kiln shuts off when gas valve turned too high.

Gas pressure is too high. Check the low pressure regulator at your gas source and have gas pressure at 7" water column for natural gas or 11" water column for propane. Another source to check is the holes in the ignition system. Enlarge the holes on the pilot to 3/32" below the thermocouple tip.

Bottom section of kiln is hotter than the top section of kiln.

Several reasons may be the cause of the bottom section firing hotter than the top section.

1. Excessive backpressure is occurring because the top port cover is closed too much. Open top port.
2. Gas is burning inside the horizontal air mixer tube. A good test to see if the gas is burning in the horizontal air mixer is to insert a broom straw about half way into the tube from the primary air opening. If the straw comes out burned, the gas mixture is burning inside the air mixer. This condition is not dangerous but it will make it nearly impossible for the kiln to reach high temperatures. Turn the gas off and slightly increase the amount of primary air in the opening. Re-ignite the kiln and begin firing again.
3. Top shelf is too close to top port.
4. Shelves are not spaced 1-inch apart.

Kiln does not get hot fast enough.

1. Primary air plate is not opened enough. Increase primary air plate opening.
2. The gas pressure in the kiln is insufficient. UpDraft gas kilns need a low pressure regulator with natural gas running on 7-inches water column pressure and propane running on a 11-inches water column pressure. DownDraft gas kilns come equipped with a low pressure regulator.
3. Gas is burning inside the horizontal air mixer tube. See number 2 above.
4. Over reduction will cause the temperature to drop considerably.
5. The orifice size is too small for the gas pressure being used. See kiln specifications on pages 10 and 22.

RETROFITTING Ignition Systems

on Olympic Torchbearer and Raku UpDraft Gas Kilns

PARTS OF IGNITION SYSTEM



18 & 23 Torchbearer and Raku gas kilns pilot bar with adjustable mounting clamps, ignition system air mixer and thermocouple holder.



28 Torchbearer and Raku gas kilns pilot ring with adjustable mounting clamps, ignition system air mixer and thermocouple holder.

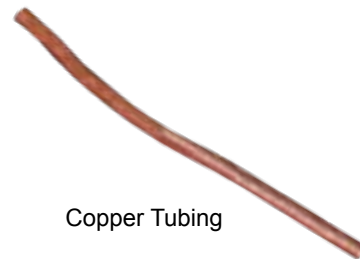

Copper Tubing



Needle Valve



Gas Thermocouple with Cotter Pin



Nipples and Gas Valve are on the kiln and will be a part of the ignition system



Magnetic Valve

Attach adjustable mounting clips to pilot bar or pilot ring to the burner stand or frame and tighten to burner stand or frame.

Attach nipples to gas valve and magnetic valve.

Install copper tubing to brass fitting on the needle valve and to the brass fitting on the air mixer.



RETROFITTING Ignition Systems

on Olympic Torchbearer and Raku UpDraft Gas Kilns

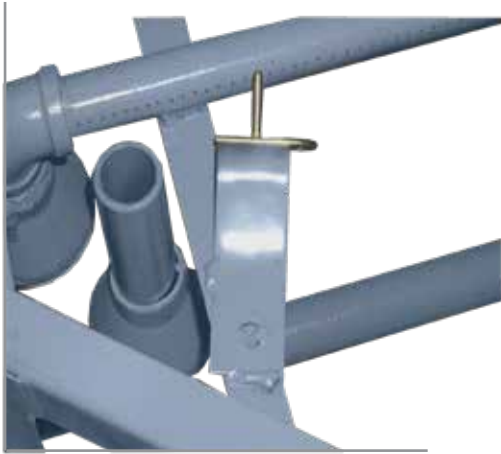

Mount thermocouple in holder and clip in place. Set 1/8" from pilot bar or pilot ring.

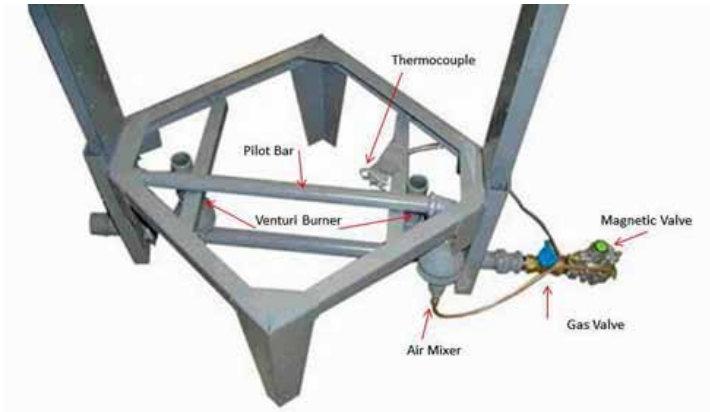

18" Gas Burner with Ignition System & Thermocouple Safety Shut-off

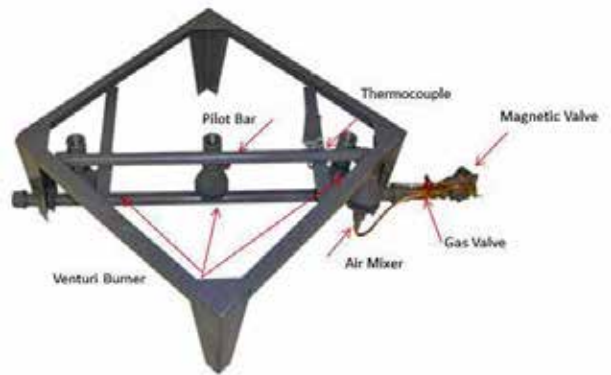

23" Gas Burner with Ignition System & Thermocouple Safety Shut-off

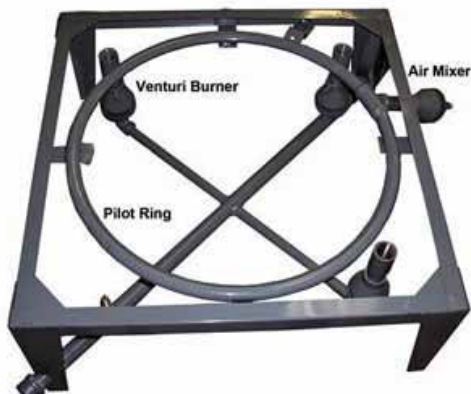

28" Gas Burner with Ignition System & Thermocouple Safety Shut-off

Orton Ceramic Pyrometric Cone Chart – Fahrenheit



Temperature Equivalent Chart for Orton Pyrometric Cones (°F) Cone Numbers 022-14

Pyrometric cones have been used to monitor ceramic firings for more than 100 years. They are useful in determining when a firing is complete, if the kiln provided enough heat, if there was a temperature difference in the kiln or if a problem occurred during the firing.

Cones are made from carefully controlled compositions. They bend in a repeatable manner (over a relatively small temperature range - usually less than 40° F). The final bending position is an indication of how much heat was absorbed.

Temperature. The temperature will be higher for faster heating rates and lower for slower heating rates. Cone bending may also be affected by reducing atmospheres or those containing sulfur oxides. Orton recommends the use of Iron-Free cones for all reduction firings (cones 010-3). If a cone is heated too fast, the cone surface fuses and binders used to make cones form gases that bloat the cone. If cones are to be fired rapidly, they should be calcined (pre-fired) before use. Cones should be calcined to about 850°F (455°C) in an air atmosphere.

Behavior of Pyrometric Cones
Typically, it takes 15 to 25 minutes for a cone to bend once it starts. This depends on the cone number. The cone bends slowly at first but once it reaches the half way point (3 o'clock), it bends quickly. When the cone tip reaches a point level with the base, it is considered properly fired. This is the point for which temperature equivalents are determined. Differences between a cone touching the shelf and a cone at the 4 o'clock position are small, usually 1 or 2 degrees.

Temperatures shown on the charts were determined under controlled firing conditions in electric kilns and an air atmosphere. Temperatures are shown for specific heating rates. These heating rates are for the last 100°C or 180°F of the firing. Different heating rates will change the equivalent

for more information on pyrometric cones, contact Orton or visit us at www.ortonceramic.com

Orton
The Edward Orton Jr. Ceramic Foundation
P.O. Box 2760 • Westerville, OH 43086-2760
(614) 895-2663 • (614) 895-5610 fax
info@ortonceramic.com
www.ortonceramic.com

Cone	Self Supporting Cones				Large Cones				Small	
	Regular		Iron Free		Regular		Iron Free		Regular	
	27	108	270	770	108	270	108	270	540	540
022	1087	1094			N/A	N/A			1166	
021	1112	1143			N/A	N/A			1189	
020	1159	1180			N/A	N/A			1231	
019	1213	1252	1283	1314	1249	1279	1333		1333	
018	1267	1319	1353	1405	1314	1350	1386		1386	
017	1301	1360	1405		1357	1402	1443		1443	
016	1368	1422	1465		1416	1461	1517		1517	
015	1382	1456	1504		1450	1501	1549		1549	
014	1396	1485	1540		1485	1537	1598		1598	
013	1485	1539	1582		1539	1578	1616		1616	
012	1549	1582	1620		1576	1616	1652		1652	
011	1575	1607	1641		1603	1638	1679		1679	
010	1636	1657	1679	1600	1627	1639	1648	1675	1623	1636
009	1665	1688	1706	1650	1686	1702	1683	1702	1683	1699
008	1692	1728	1753	1695	1735	1755	1728	1749	1733	1751
007	1764	1789	1809	1747	1780	1800	1783	1805	1778	1796
006	1798	1828	1855	1776	1816	1828	1823	1852	1816	1825
05½	1839	1859	1877	1814	1854	1870	1854	1873	1852	1868
05	1870	1888	1911	1855	1899	1915	1886	1915	1890	1911
04	1915	1945	1971	1909	1942	1956	1940	1958	1940	1953
03	1960	1987	2019	1951	1990	1999	1987	2014	1989	1996
02	1972	2016	2052	1983	2021	2039	2014	2048	2016	2035
01	1999	2046	2080	2014	2053	2073	2043	2079	2052	2070
1	2028	2079	2109	2046	2082	2098	2077	2109	2079	2095
2	2034	2088	2127	2066	2109	2124	2088	2124	2104	2120
3	2039	2106	2138	2066	2109	2124	2106	2134	2104	2120
4	2086	2124	2161	2066	2109	2124	2120	2158	2104	2120
5	2118	2167	2205	2066	2109	2124	2163	2201	2104	2120
5½	2133	2197	2237	2066	2109	2124	N/A	N/A	N/A	N/A
6	2165	2232	2269	2066	2109	2124	2228	2266	2291	2307
7	2194	2262	2295	2066	2109	2124	2259	2291	2316	2332
8	2212	2280	2320	2066	2109	2124	2277	2316	2332	2403
9	2235	2300	2336	2066	2109	2124	2295	2332	2340	2426
10	2284	2345	2381	2066	2109	2124	2340	2377	2394	2437
11	2322	2361	2399	2066	2109	2124	2359	2394	2415	2471
12	2345	2383	2419	2066	2109	2124	2379	2415	2410*	2455*
13*	2389	2428	2458	2066	2109	2124	2410*	2455*	2410*	N/A
14*	2464	2489	2523	2066	2109	2124	2530*	2491*	2491*	N/A

These tables provide a guide for the selection of cones. The actual bending temperature depends on firing conditions. Once the appropriate cones are selected, excellent, reproducible results can be expected. Temperatures shown are for specific mounted height above base. For Self Supporting - 1 1/4"; for Large - 2"; for Small - 1/2". For Large Cones mounted at 1 1/4" height, use Self Supporting temperatures. * These Large Cones have different compositions and different temperature equivalents.

Temperature Equivalent Chart for Orton Pyrometric Cones (°C) Cone Numbers 022-14



Pyrometric cones have been used to monitor ceramic firings for more than 100 years. They are useful in determining when a firing is complete, if the kiln provided enough heat, if there was a temperature difference in the kiln or if a problem occurred during the firing.

Cones are made from carefully controlled compositions. They bend in a repeatable manner (over a relatively small temperature range - usually less than 40°F). The final bending position is an indication of how much heat was absorbed.

temperature. The temperature will be higher for faster heating rates and lower for slower heating rates.

Cone bending may also be affected by reducing atmospheres or those containing sulfur oxides. Orton recommends the use of Iron-Free cones for all reduction firings (cones 010-3). If a cone is heated too fast, the cone surface fuses and binders used to make cones form gases that bloat the cone. If cones are to be fired rapidly, they should be calcined (pre-fired) before use. Cones should be calcined to about 850°F (455°C) in an air atmosphere.

Behavior of Pyrometric Cones

Typically, it takes 15 to 25 minutes for a cone to bend once it starts. This depends on the cone number. The cone bends slowly at first but once it reaches the half way point (3 o'clock), it bends quickly. When the cone tip reaches a point level with the base, it is considered properly fired. This is the point for which temperature equivalents are determined. Differences between a cone touching the shelf and a cone at the 4 o'clock position are small, usually 1 or 2 degrees.

Temperatures shown on the charts were determined under controlled firing conditions in electric kilns and an air atmosphere. Temperatures are shown for specific heating rates. These heating rates are for the last 100°C or 180°F of the firing. Different heating rates will change the equivalent

for more information on pyrometric cones, contact Orton or visit us at www.ortonceramik.com

Orton
The Edward Orton Jr. Ceramic Foundation
P.O. Box 2760 • Westerville, OH 43086-2760
(614) 895-2663 • (614) 895-5610 fax
info@ortonceramik.com
www.ortonceramik.com

Cone	Self Supporting Cones						Large Cones				Small	
	Regular		Heating Rate °C/hour (last 100°C of firing)				Regular		Iron Free		Regular	Small
	15	60	150	15	60	150	60	150	60	150	300	
022	586	590									630	
021	600	617									643	
020	626	638									666	
019	656	678	695				676	693			723	
018	686	715	734				712	732			752	
017	705	738	763				736	761			784	
016	742	772	796				769	794			825	
015	750	791	818				788	816			843	
014	757	807	838				807	836			870	
013	807	837	861				837	859			880	
012	843	861	882				858	880			900	
011	857	875	894				873	892			915	
010	891	903	915	871	886	893	898	913	884	891	919	
09	907	920	930	899	919	928	917	928	917	926	955	
08	922	942	956	924	946	957	942	954	945	955	983	
07	962	976	987	953	971	982	973	985	970	980	1008	
06	981	998	1013	969	991	998	995	1011	991	996	1023	
05½	1004	1015	1025	990	1012	1021	1012	1023	1011	1020	1043	
05	1021	1031	1044	1013	1037	1046	1030	1046	1032	1044	1062	
04	1046	1063	1077	1043	1061	1069	1060	1070	1060	1067	1098	
03	1071	1086	1104	1066	1088	1093	1086	1101	1087	1091	1131	
02	1078	1102	1122	1084	1105	1115	1101	1120	1102	1113	1148	
01	1093	1119	1138	1101	1123	1134	1117	1137	1122	1132	1184	
1	1109	1137	1154	1119	1139	1148	1136	1154	1137	1146	1184	
2	1112	1142	1164				1142	1162			1190	
3	1115	1152	1170	1130	1154	1162	1152	1168	1151	1160	1196	
4	1141	1162	1183				1160	1181			1209	
5	1159	1186	1207				1184	1205			1221	
5½	1167	1203	1225				N/A	N/A			N/A	
6	1185	1222	1243				1220	1241			1255	
7	1201	1239	1257				1237	1255			1264	
8	1211	1249	1271				1247	1269			1300	
9	1224	1260	1280				1257	1278			1317	
10	1251	1285	1305				1282	1303			1330	
11	1272	1294	1315				1293	1312			1336	
12	1285	1306	1326				1304	1324			1355	
13	1310	1331	1348				1321*	1346*			N/A	
14	1351	1365	1384				1388*	1366*			N/A	

These tables provide a guide for the selection of cones. The actual bending temperature depends on firing conditions. Once the appropriate cones are selected, excellent, reproducible results can be expected. Temperatures shown are for specific mounted height above base. For Self Supporting - 1 3/4"; for Large - 2"; for Small - 1 1/8". For Large Cones mounted at 1 3/4" height, use Self Supporting temperatures. * These Large Cones have different compositions and different temperature equivalents.

This Warranty Is Applicable to All Kilns Manufactured by Olympic Kilns That Are Used for Ceramics, Pottery and Glass. Cone 10 Kilns Have a One-Year Warranty and All Other Kilns Have a Two-Year Warranty. Certain Parts, Thermocouple, Kiln Sitter Tube Assembly, Are Not Covered Under Warranty, Nor Is Kiln Furniture.

LIMITED KILN WARRANTY

Haugen Manufacturing, Incorporated guarantees to the original purchaser that any defects in OLYMPIC KILNS which become apparent within two years (one year for the Dawson Kiln Sitter and safety timer which is covered by warranty from W. P. Dawson, Inc. and kilns rated at cone 10) will be remedied as specified below.

Our warranty, of course, does not cover any kiln damaged or altered by you or others after it leaves our factory. Our warranty does not cover damage due to reduction or salt firing, over-firing, exceeding the maximum cone or temperature ratings, improper installation, use of electrical voltages different than those specified, or firing material other than ceramics.

If a defect of manufacturer becomes apparent, and your retailer does not resolve it to your satisfaction, we will in the following manner: Within (6;) days of the first indication of a defect, tell us in writing of defect, and the date, place and proof of the your purchase. We will contact you to determine what parts seem to warrant repair and to instruct you as to shipment of the kiln parts. You will dismantle, package, and ship the parts we request (and no others), to us at your cost, freight prepaid. If the kiln has a defect of manufacture we will repair, replace or refund as is appropriate, within (30) days. We will ship to you at our cost in your package, for you to reinstall at your cost. If the parts shipped by you to us are in need of repair or replacement for something which is not covered by this warranty, we will not perform the work until you have authorized the work and made arrangements for payment. If substantially an entire kiln is returned for repair under warranty, you will prepay the cost of packaging and shipping both to and from the factory.

We shall in no event be liable for injuries to persons or property or for incidental, contingent, special or consequential damages arising from the use of our products. Some states do not allow the exclusion or limitation of incidental or consequential damages, so the above limitation or exclusion may not apply to you. This warranty gives you specific legal rights, and you may also have other rights which vary from state to state.

HAUGEN MANUFACTURING, INC.
P. O. BOX 1347
4225 THURMON TANNER ROAD
FLOWERY BRANCH, GA 30542

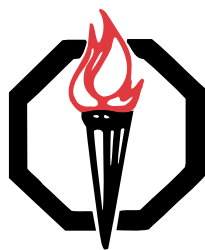

OLYMPIC KILNS

www.greatkilns.com

Division of Haugen Mfg.

Sales (800) 241-4400 • Help Line (770) 967-4009

P.O. Box 1347 • 4225 Thurmon Tanner Road • Flowery Branch, GA 30542