

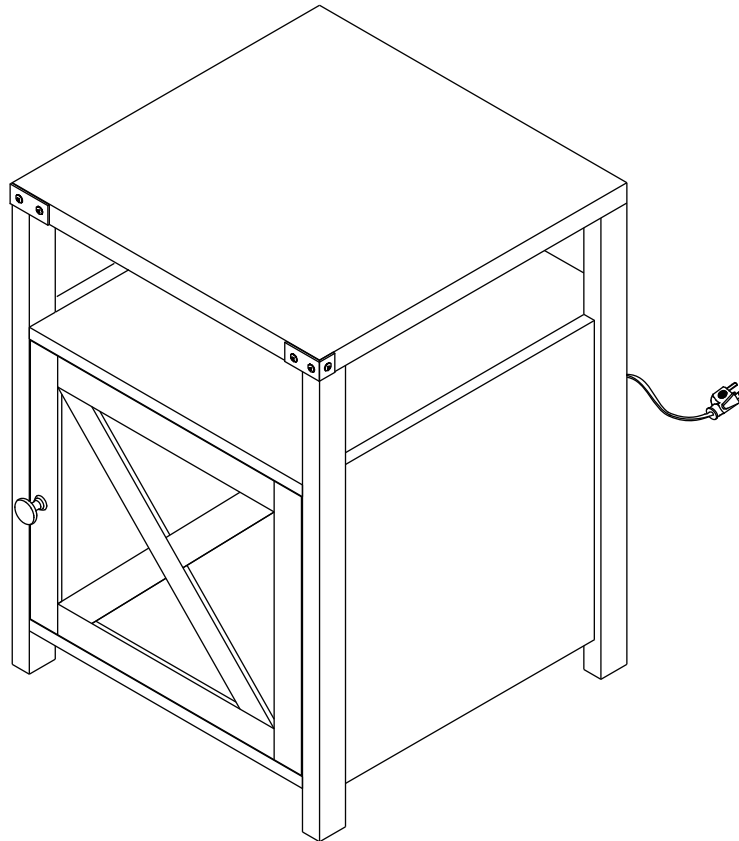

B4P023 (S)



As this item contains many parts, please read the installation instruction carefully before installation . Please use tools properly and carefully. If you have any questions about the product and installation, please contact us.

service@vabchesofficial.com

Our professional after-sales team will serve you online all day.

Before You Start

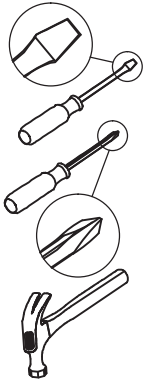

- ✓ Read through each step carefully and follow the proper order
- ✓ Separate and count all your parts and hardware
- ✓ Give yourself enough room for the assembly process
- ✓ Have the following tools: Flat Head Screwdriver, #2 Phillips Head Screwdriver and Hammer
- ✓ Caution: If using a power drill or power screwdriver for screwing, please be aware of to slow down and stop when screw is tight. Failure to do so may result in stripping the screw. (Assembly speed can be increased by using electric screwdriver)

Helpful Hints

PEOPLE NEEDED FOR ASSEMBLY: 1-2

- Open your item in the area you plan to keep it to avoid excessive heavy lifting.



- Identify, sort and count the parts before attempting assembly.

- Compression dowels are lightly tapped in with a hammer.



- Slides are labeled with an **R** (right) and **L** (left) for proper placement.



- Make sure to always face the point on the top of the Cam Lock towards the outer edge.

- If there is a back panel in the package, please install it to make sure your unit is complete and sturdy.



- Please fix all the screws provided for the back panel which can enhance product stability. If it is difficult to fix it when tightening, it can be fixed with the help of a hammer and then tightened.



- Do NOT use harsh chemicals or abrasive cleaners on this item.



- Never push, pull, or drag your furniture.

Board Identification

Not actual size

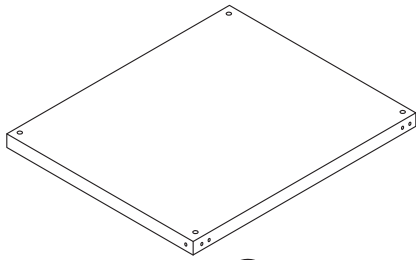

①

TOP

Qty: 1

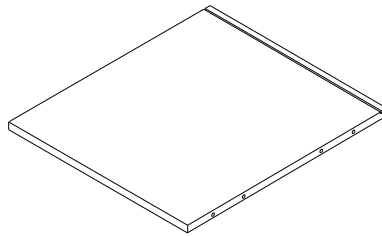

②

BOTTOM

Qty: 1

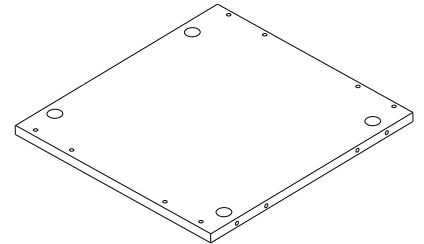

③

SIDE PANEL

Qty: 2

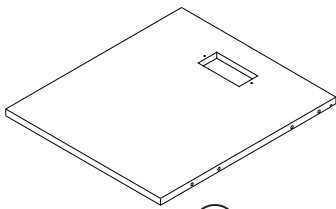

④

FIXED SHELF

Qty: 1

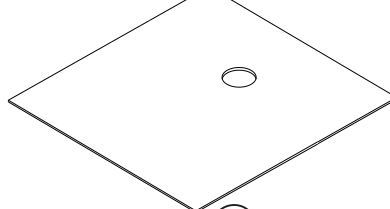

⑤

BACK PANEL

Qty: 1

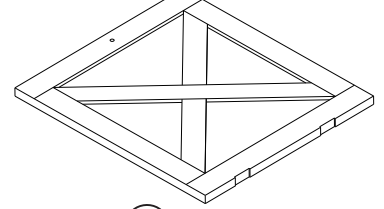

⑥

DOOR

Qty: 1

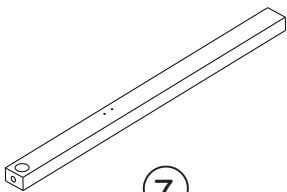

⑦

LEFT FRONT LEG

Qty: 1

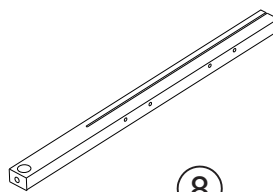

⑧

LEFT REAR LEG

Qty: 1

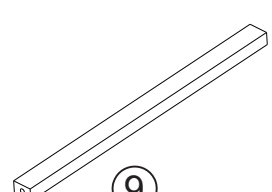

⑨

RIGHT FRONT LEG

Qty: 1

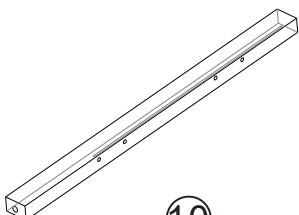

⑩

RIGHT REAR LEG

Qty: 1

Board Identification

Not actual size

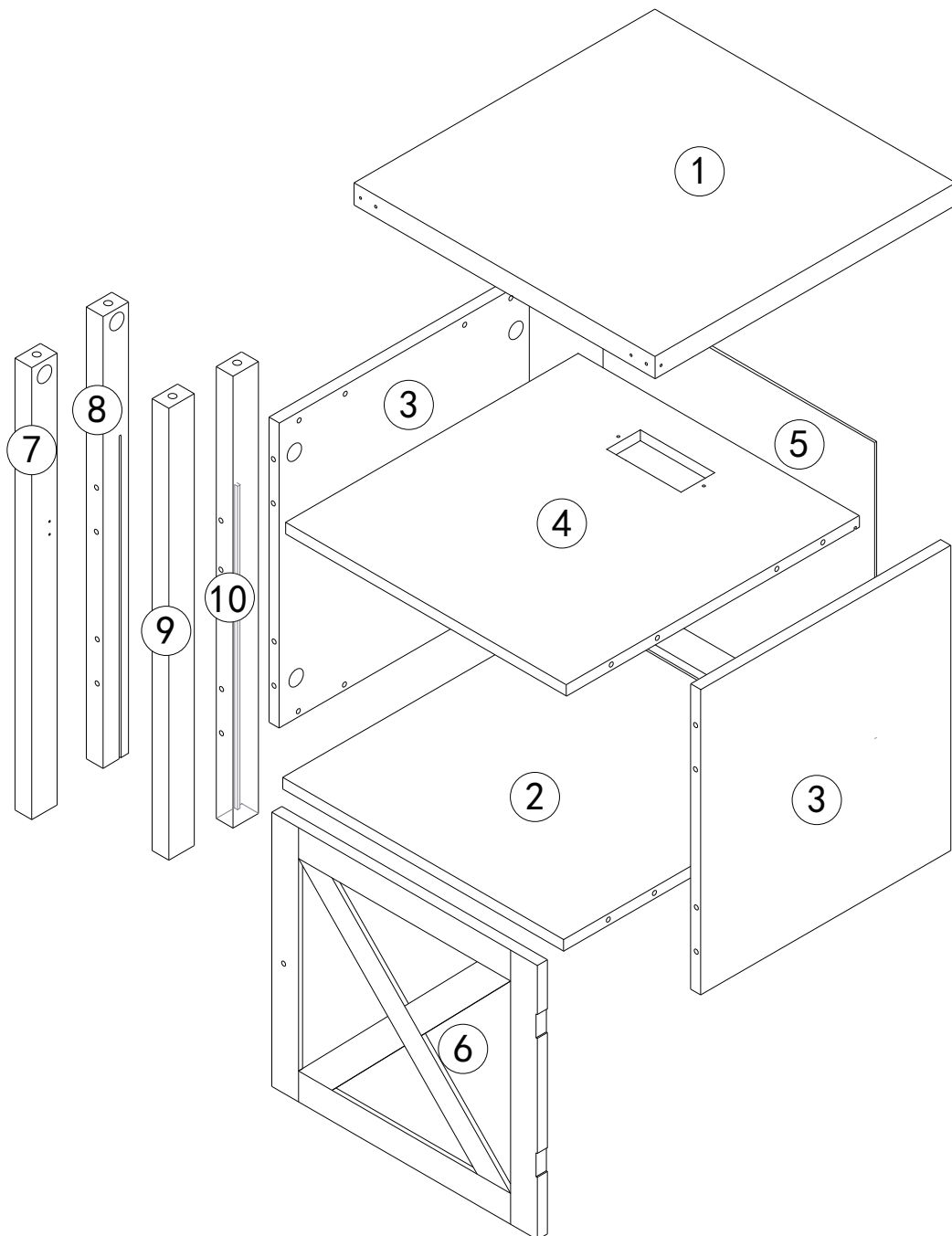

Part List

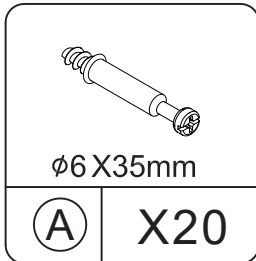

CAM LOCK
spare: 2

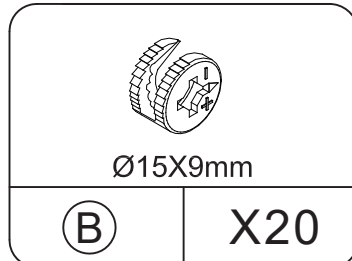

CAM BOLT
spare: 2

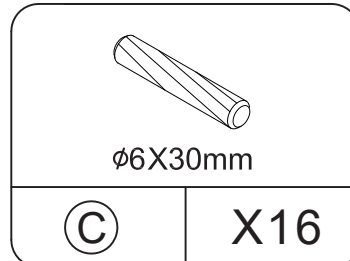

WOOD DOWEL
spare: 2

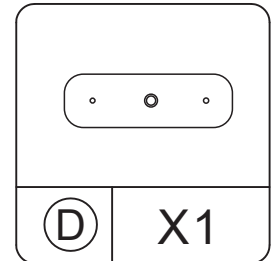

METAL PLATE

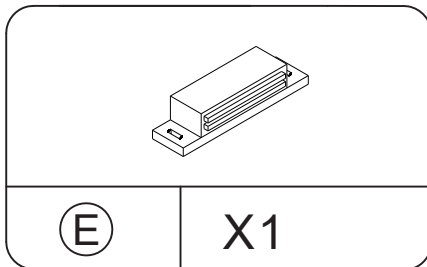

MAGNET

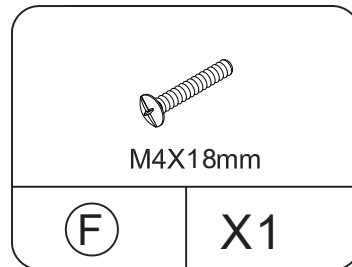

SCREW

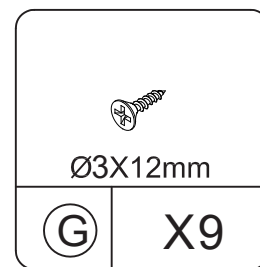

SCREW
spare: 2

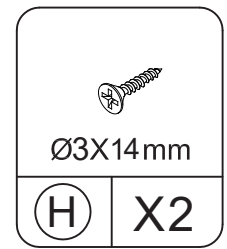

SCREW

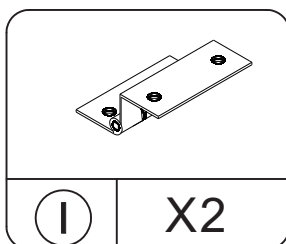

HINGE

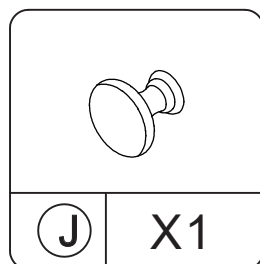

HANDLE

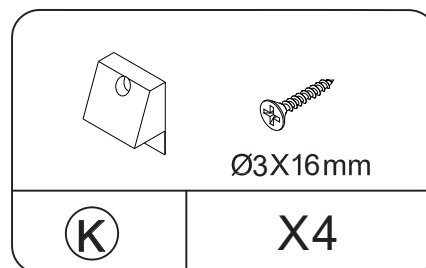

SCREW

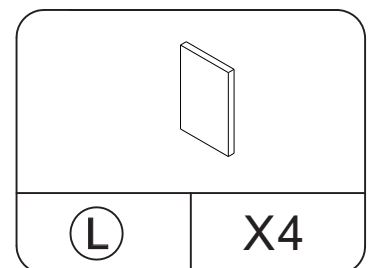

EVA

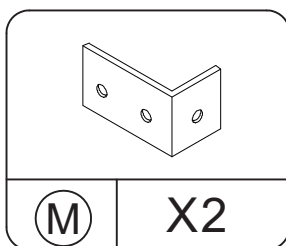

METAL CONOR

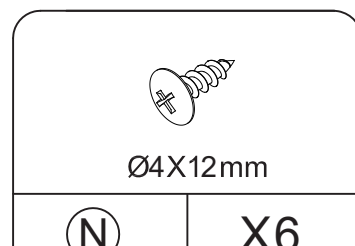

SCREW
spare: 1

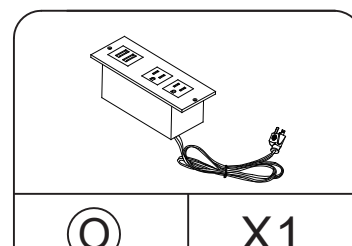

USB

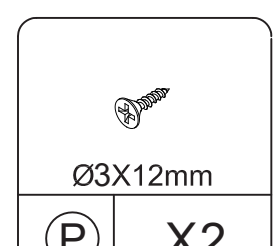

SCREW

Part List

Cam Lock Fastening System

Insert the cam bolt into the hole first, then insert the cam lock and lock it.

1

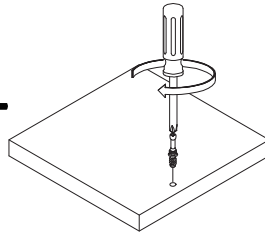

2

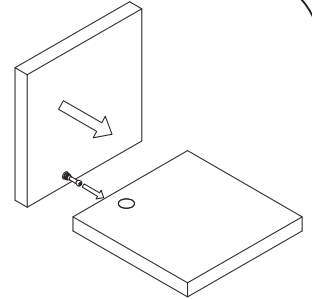

3

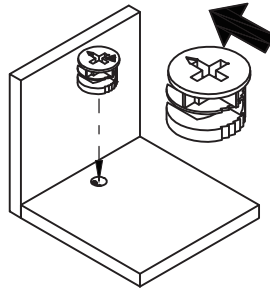

The opening must point toward the edge of the board

4

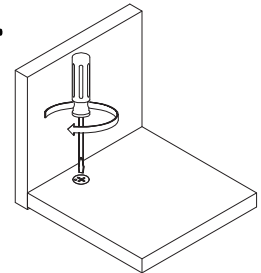

STEP 1

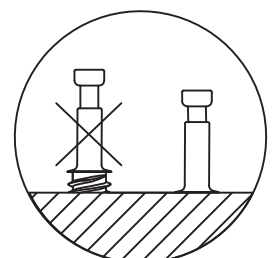
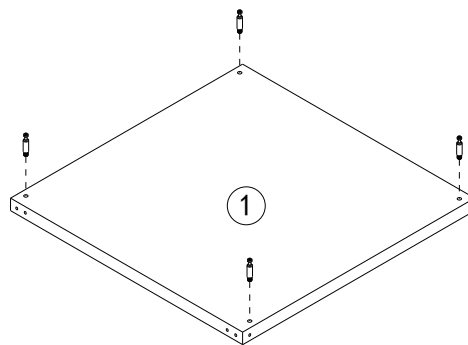
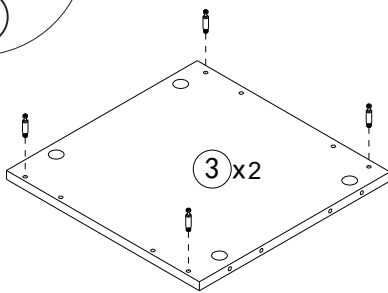
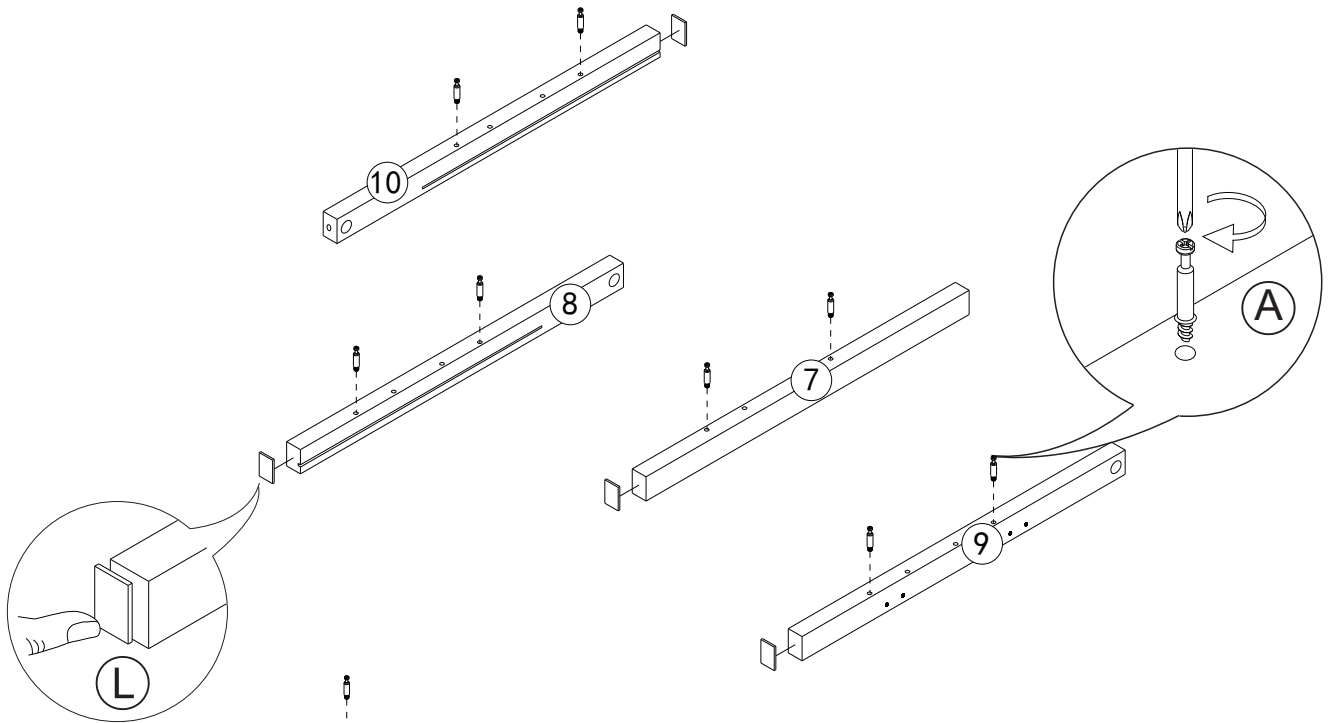
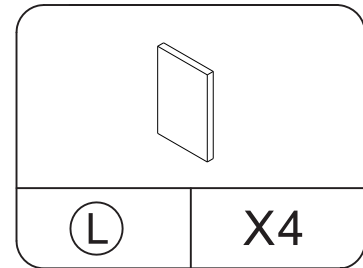
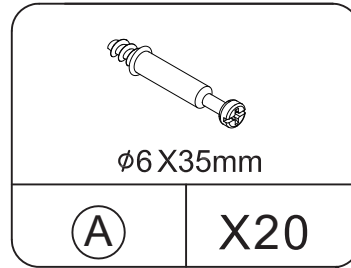
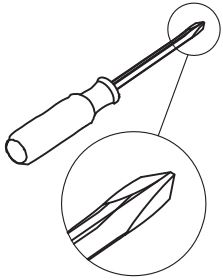

STEP 2

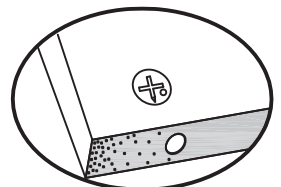
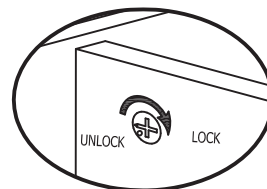
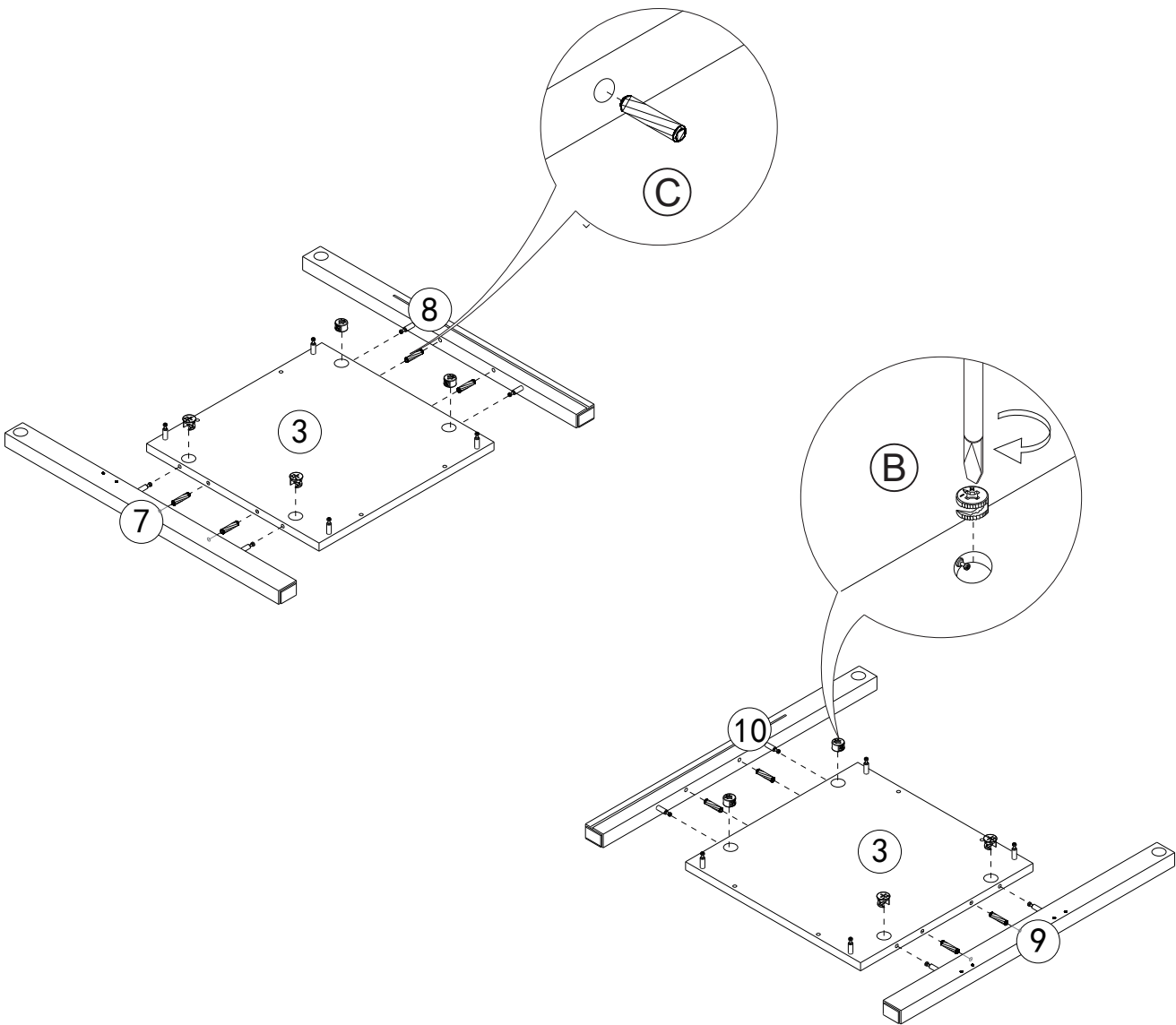
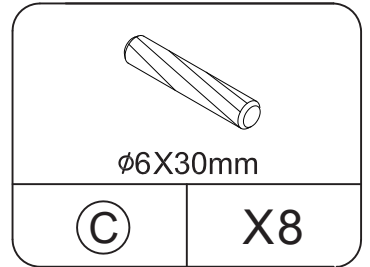
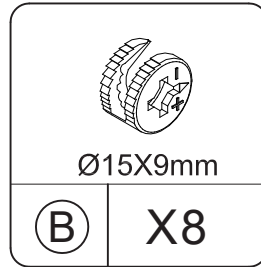
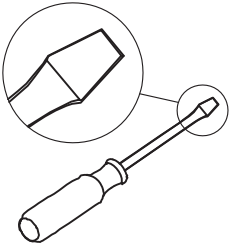

Proper orientation of CAM LOCK

STEP 3

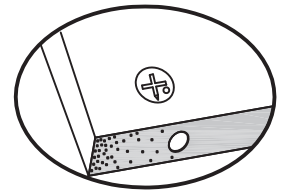
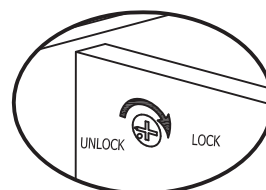
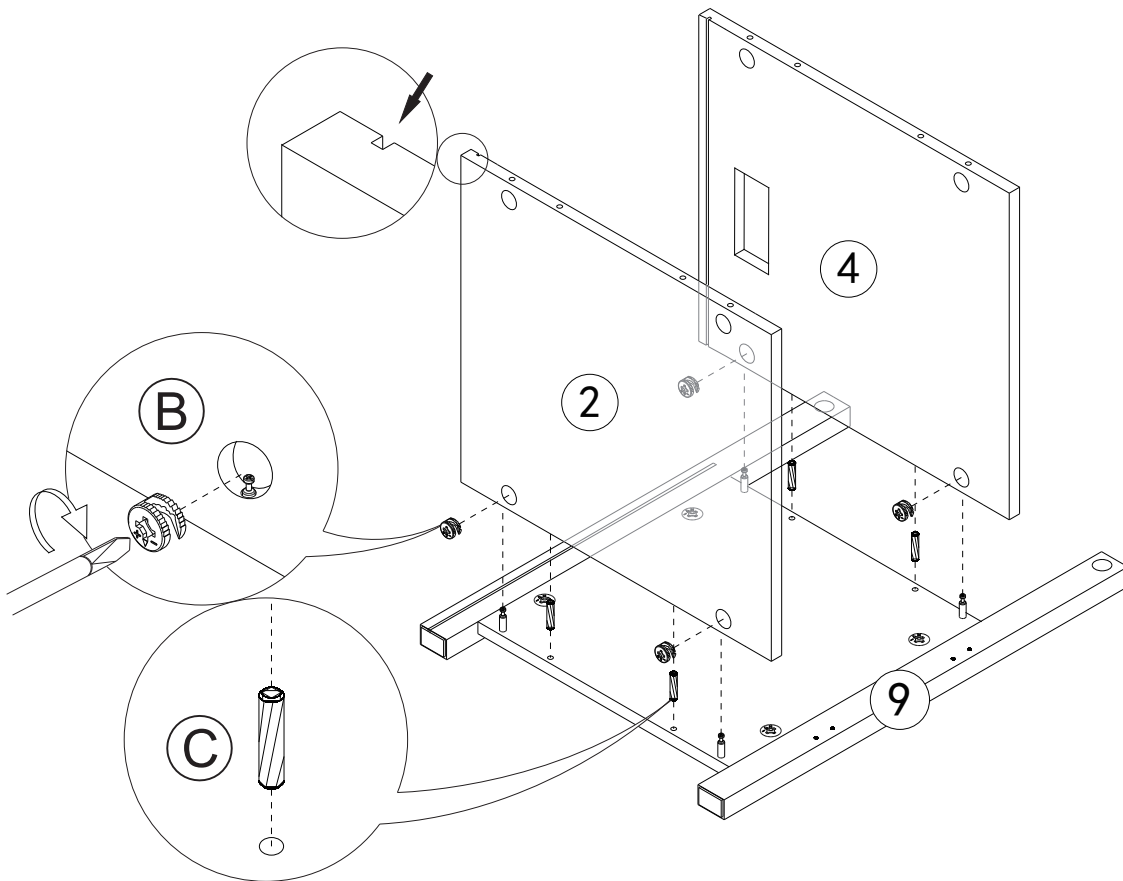
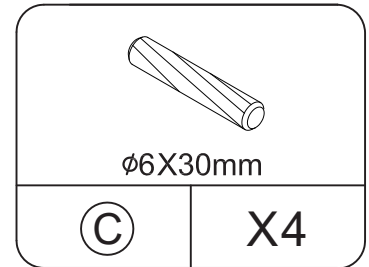
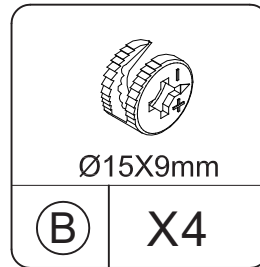
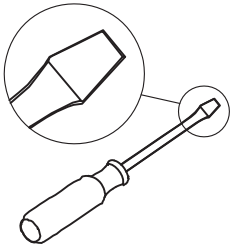

Proper orientation of CAM LOCK

STEP 4

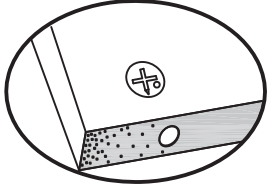
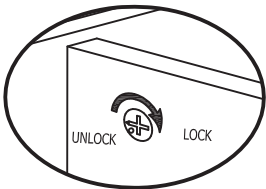
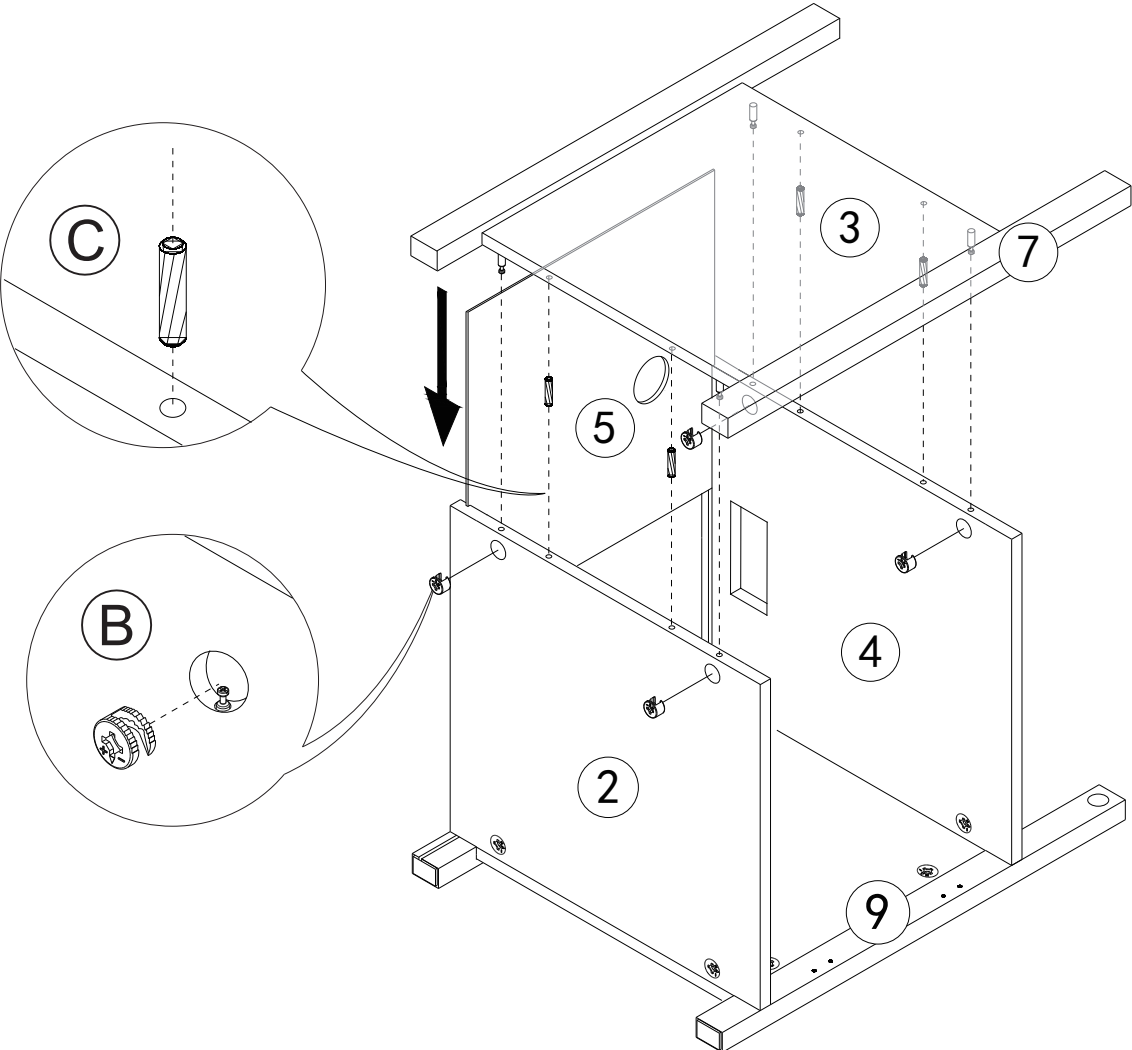
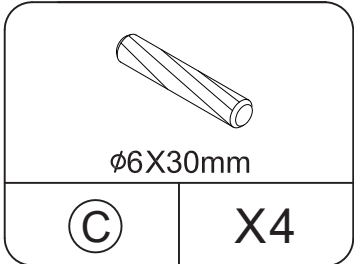
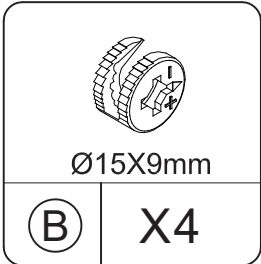
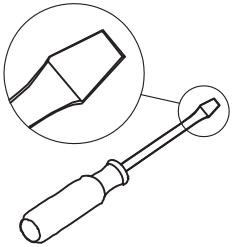

Proper orientation of CAM LOCK

STEP 5

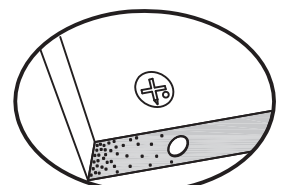
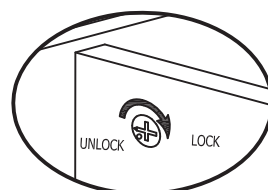
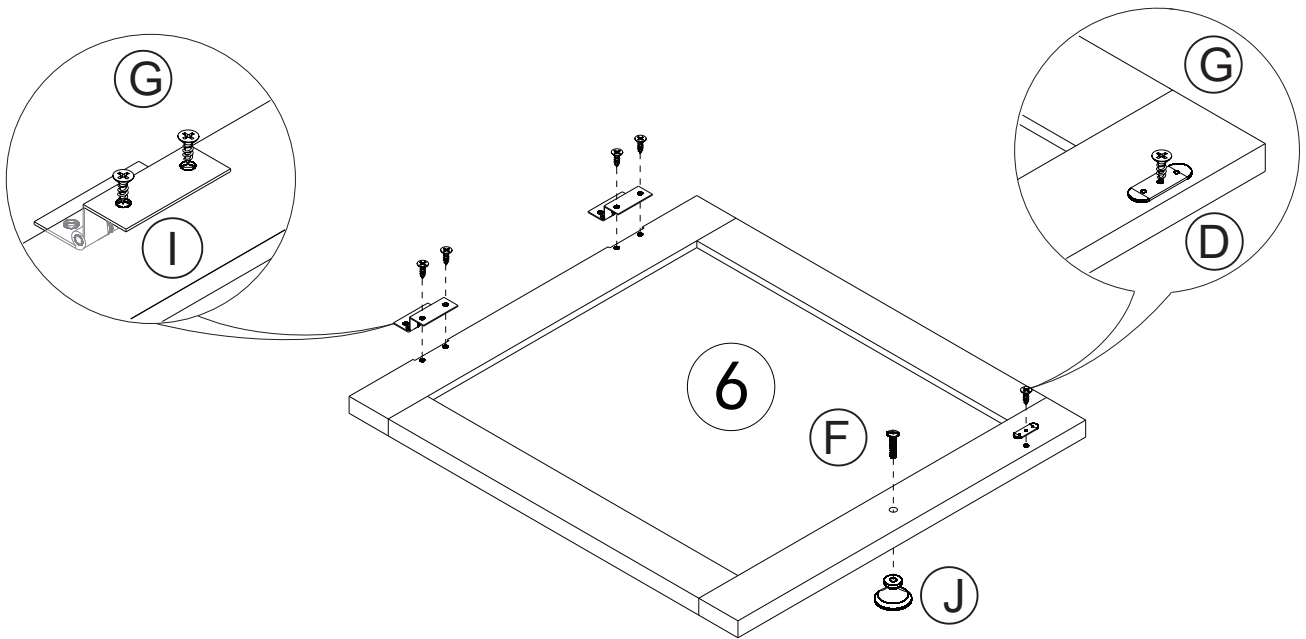
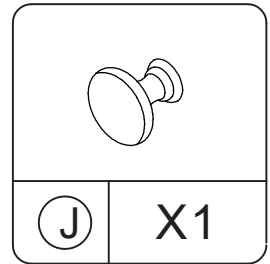
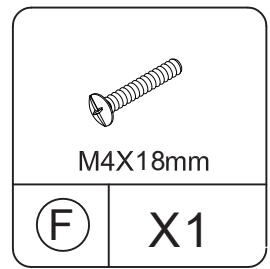
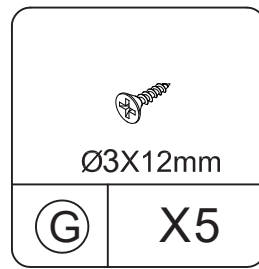
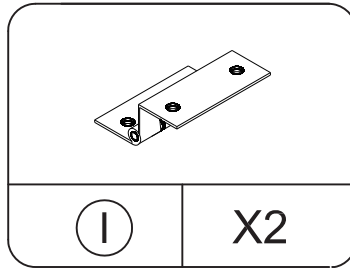
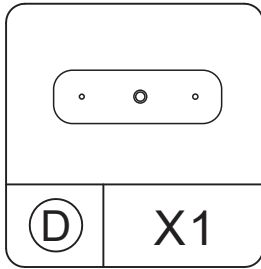
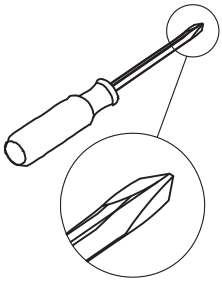

Proper orientation of CAM LOCK

STEP 6

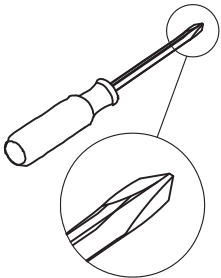

 Ø3X12mm	
G	X4

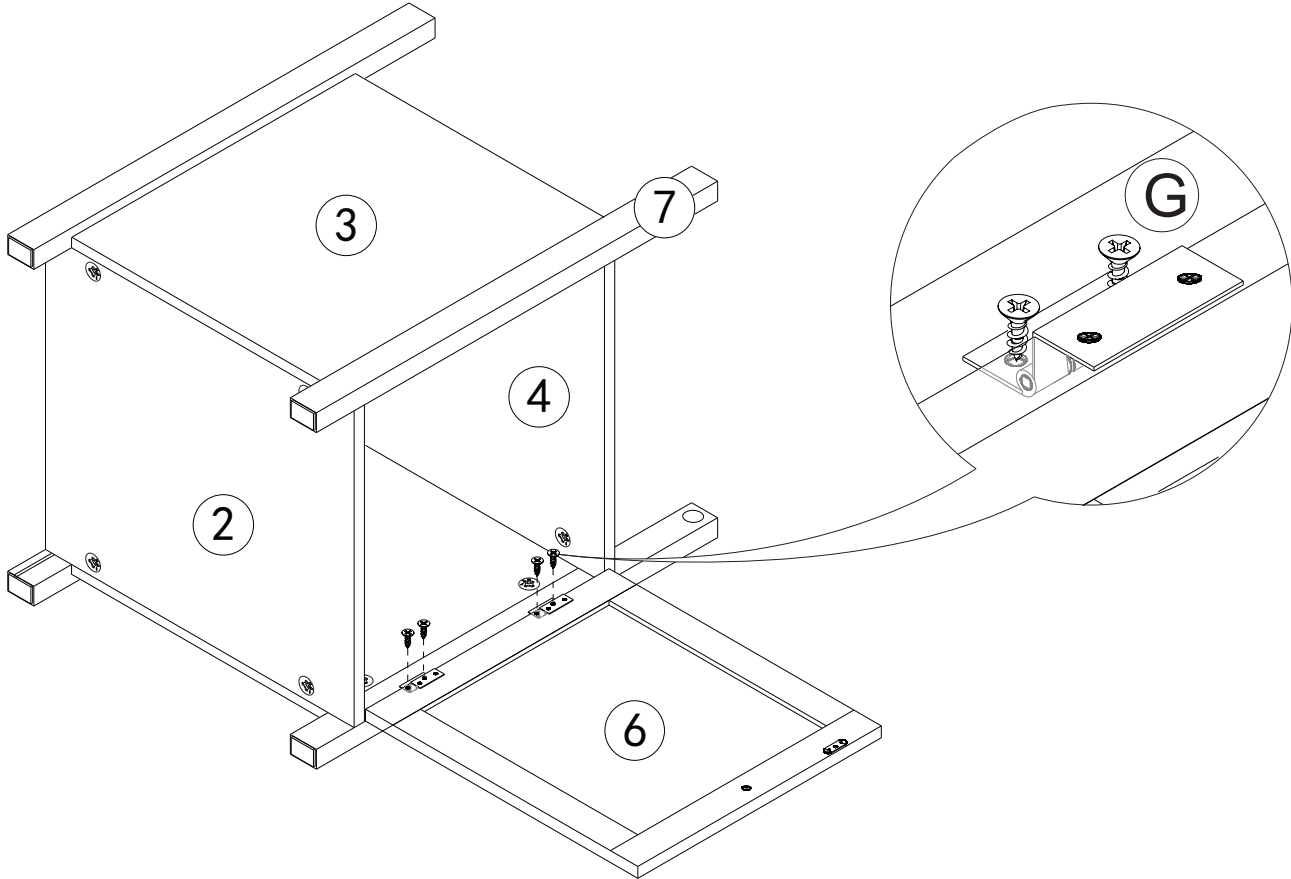

STEP 7

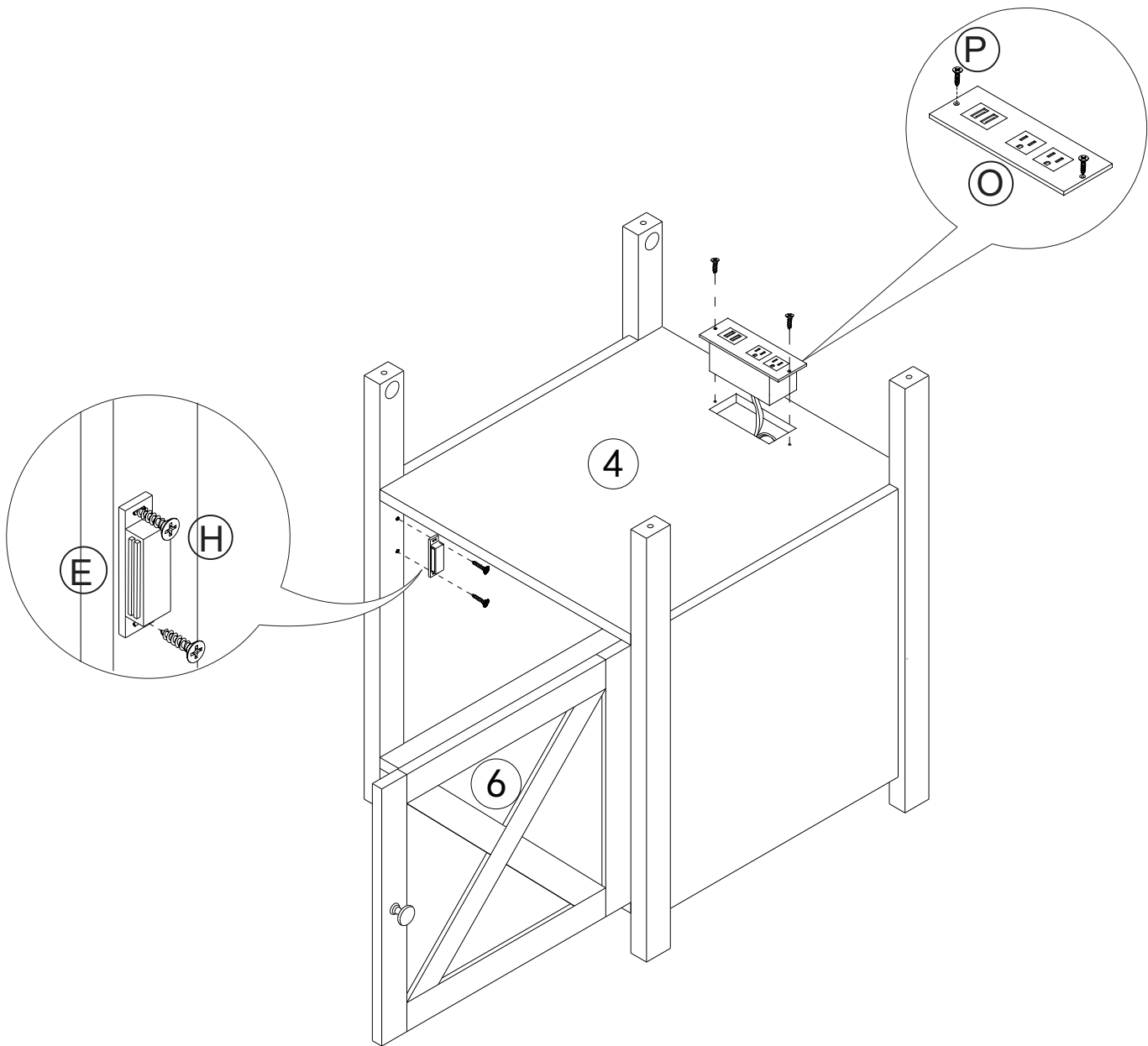
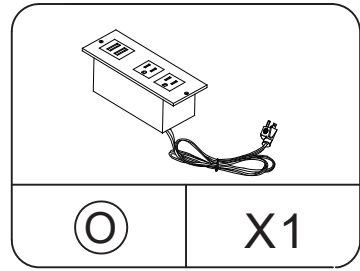
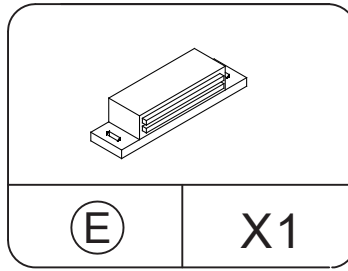
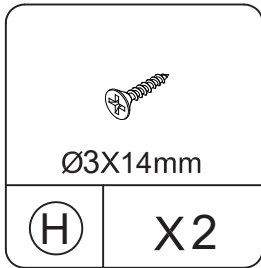
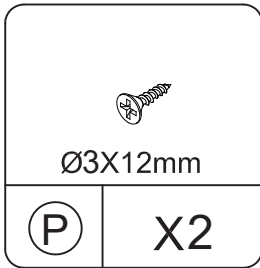
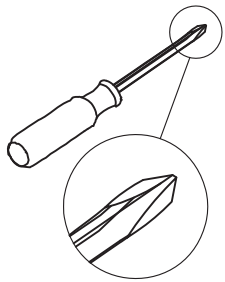

STEP 8

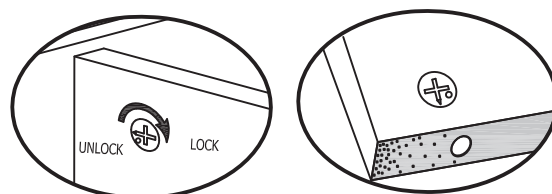
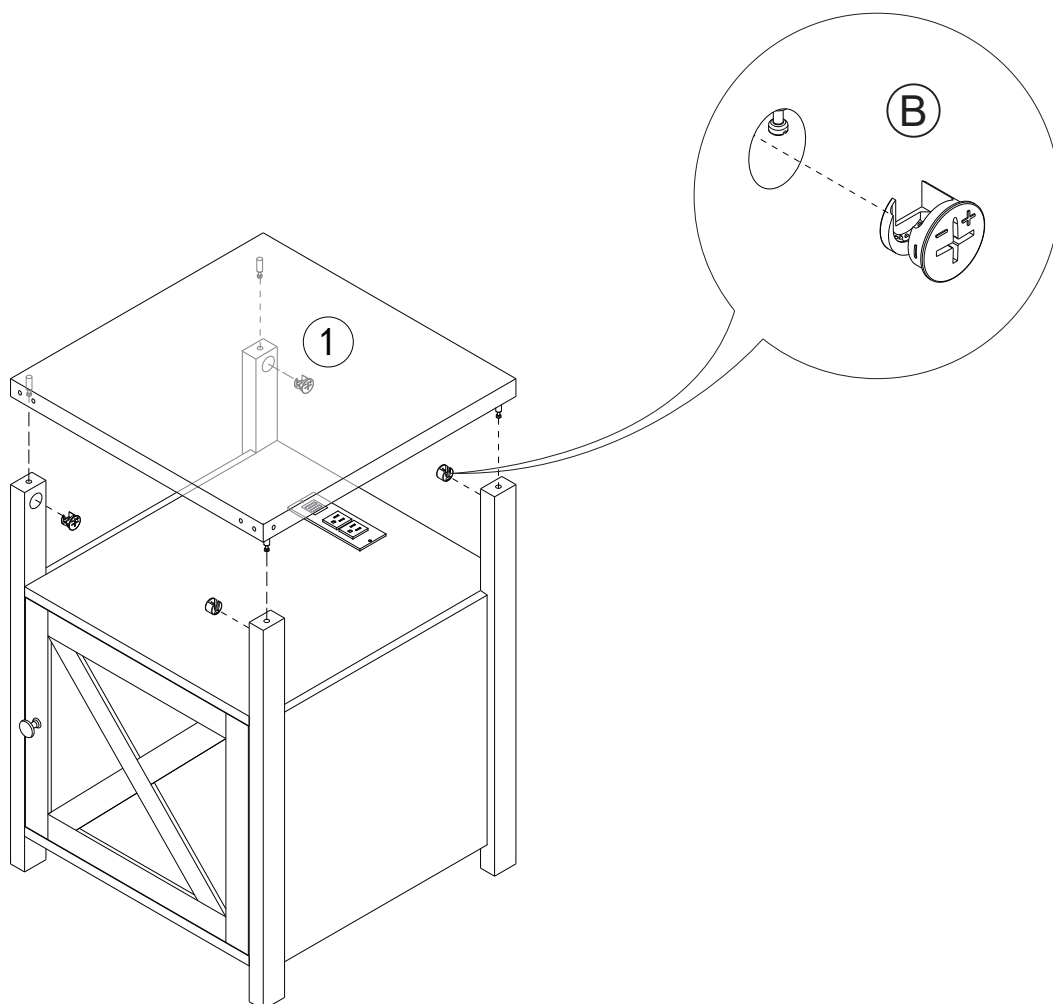
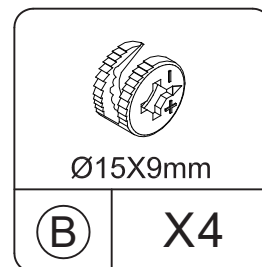
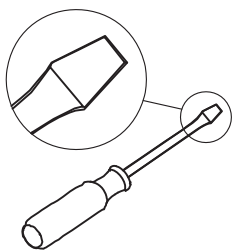

Proper orientation of CAM LOCK

STEP 9

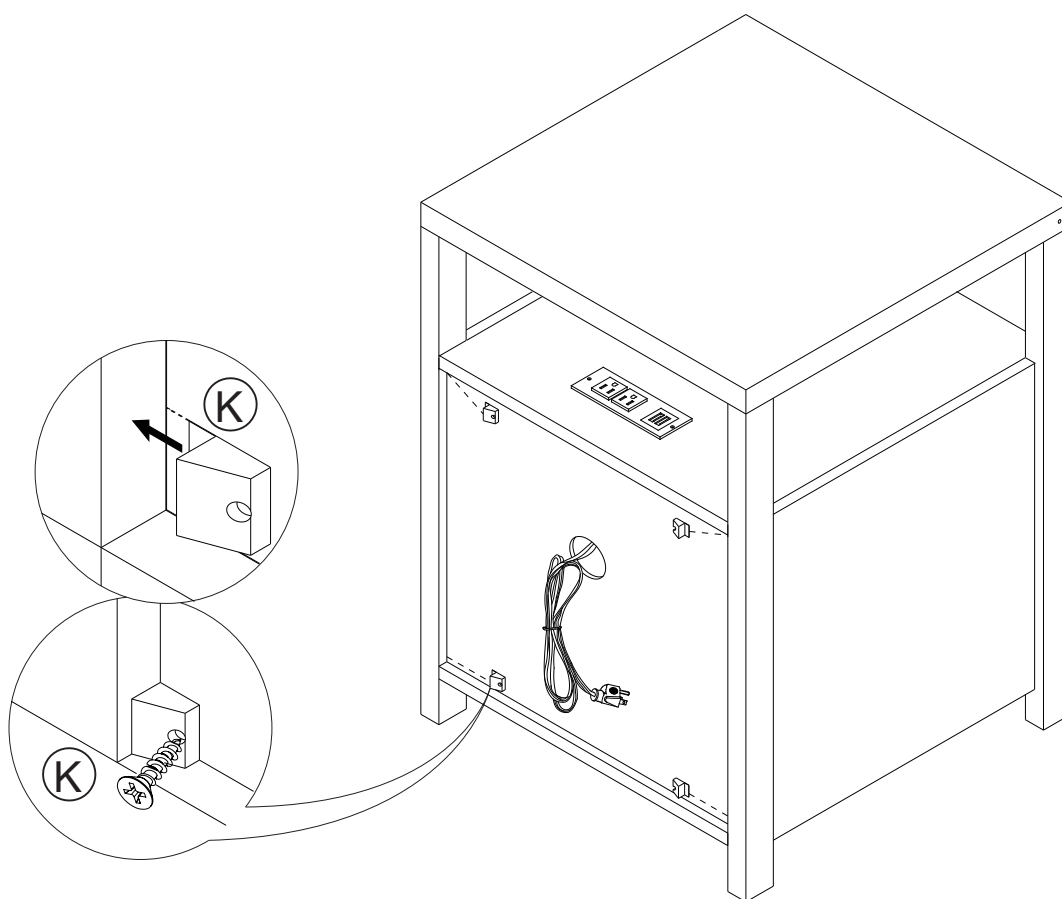
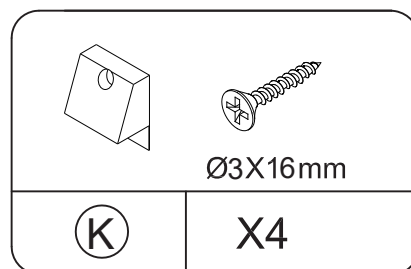
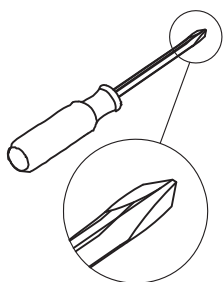

STEP 10

