



Baterias LiFePO4 desde 2015



CATALOGO Y GUIA

Precios IVA incluido

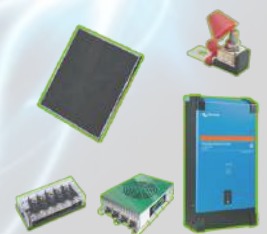

**TU TIENDA FIABLE
PARA ENERGÍA INAGOTABLE**

<https://litio.tienda>
info@litio.tienda +39 351 612 5606

LITIO STORE SRL - VIA GIOTTO, 2, 06028, SIGILLO (PG), ITALIA



11 AÑOS DE GARANTÍA en nuestras baterías

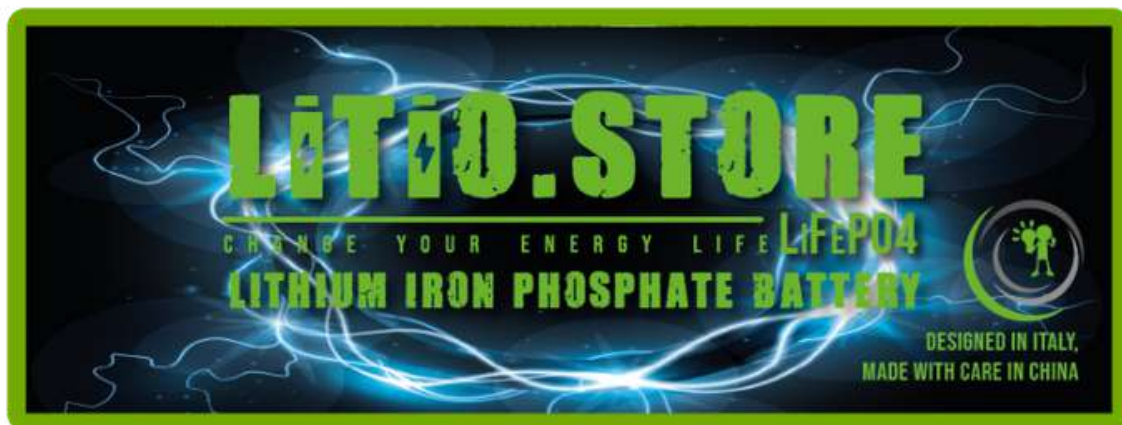

Su MEJOR socio de baterías de litio para
MOTORES ELÉCTRICOS y ENERGÍA A BORDO



**LOS MEJORES ACCESORIOS
PARA SU SISTEMA ELÉCTRICO 12V-96V**

Tu seguridad, nuestra prioridad

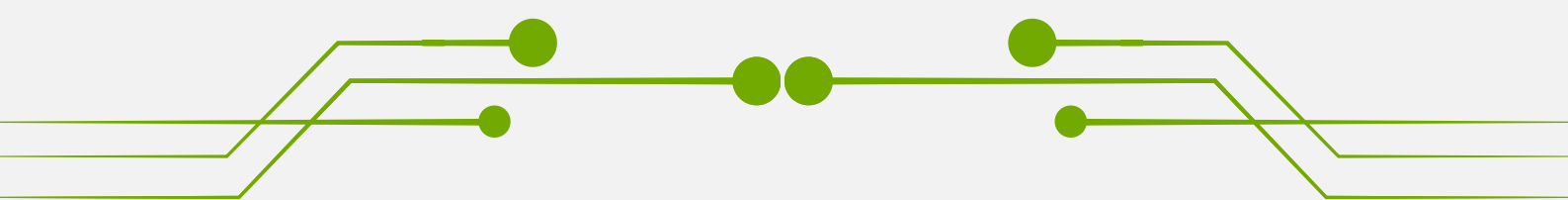

1
2
3
4
5

ÍNDICE

AGENCIA

Quienes somos 07

Nuestras ventajas 08

La banda del Litio 09

Nuestros clientes 10

BATERÍAS DE LITIO-HIERRO-FOSFATO

Las ventajas de las baterías LiFePO4 12

Comparación de precios de plomo y litio 13

Aplicaciones 14

NUESTRAS BATERÍAS DE LITIO-HIERRO-FOSFATO

Serie CLASSIC **diec
séis**

Serie BLUETOOTH 18

Serie LITTLE 20

Serie GHOST 22

Serie ULTRASLIM 24

Serie TOGETHER 26

Serie STARTER 28

Vehículos eléctricos Serie PRO EVs 30

Especificaciones técnicas 33

Seguridad: BMS incluido 34

ACCESORIOS PARA BATERÍAS LIFEPO4

Recarga con ALTERNADOR 36

Recarga con PANELES SOLARES 53

Recarga con RED 220V 64

Monitor de batería 71

Inversor 80

Convertidor CC-CC 85

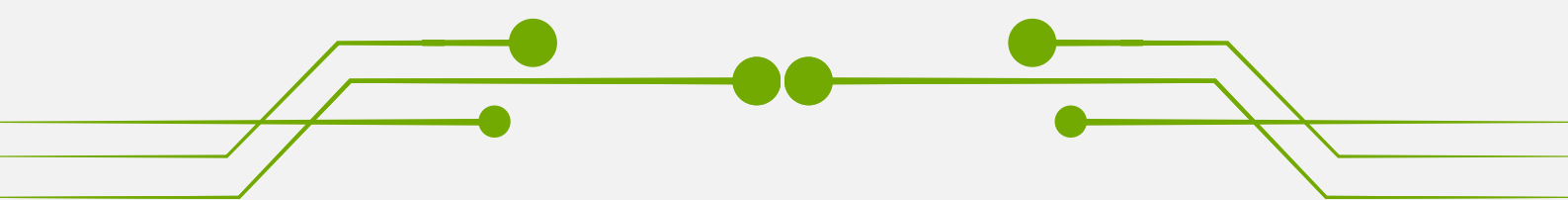

ACCESORIOS PARA SISTEMAS ELÉCTRICOS 12V-96V

Cables	87
Fusibles	88
interruptor de batería	95
BUSBAR barra colectora	96
Conectores	97
C.A.	100

BATERÍAS PARA MOTORES ELÉCTRICOS

Cómo pasar del plomo al litio	102
Diagrama del motor de combustión/eléctrico de 12 V	104
Lista de componentes y precio	105
Esquemas de 24V y 36V	106
Precio y kit de barco eléctrico de 48 V	110

BATERÍAS PARA SERVICIOS A BORDO 112

¿Qué hay que instalar?	116
¿Cuánto cuesta pasar del plomo al litio?	117
Sistema COMPLETO Victron Energy 12V	118
Sistema completo de 24V (1)	120
Sistema completo de 24V (2)	121
Sistema completo de 48V (1)	122
Sistema completo de 48V (2)	123

CONSEJOS GENERALES 124

USO Y MANTENIMIENTO 125



LITIO.STORE



LITIO.TIENDA

QUIENES SOMOS

Visita el sitio [HTTPS://LITIO.TIENDA](https://litio.tienda)



LITIO.STORE

CLEANER ENERGY FOR A CLEANER WORLD

LITIO STORE SRL es tu tienda confiable de energía inagotable. Desde 2015, contribuimos a hacer del mundo un lugar más limpio. Especializados en baterías **LiFePO₄**, **supercondensadores** y **baterías de sodio**, ofrecemos soluciones ecológicas para cada aplicación. Con una experiencia consolidada, garantizamos productos de alta calidad y asesoramiento experto en los sectores de caravanas y náutica, personalizando cada solución según las necesidades del cliente. Nuestros clientes pueden contar con innovación continua y productos exclusivos en el mercado.

NUESTRAS VENTAJAS



CALIDAD SUPERIOR

La mayor variedad de baterías LiFePO₄ de Europa 12V-96V, tanto para motores eléctricos como para servicios a bordo.



SOLUCIONES COMPLETAS y ASOCIACIONES OFICIALES PREMIUM

Además de baterías, suministramos inversores, reguladores, cargadores de baterías y accesorios de alta gama como SIMARINE, VICTRON ENERGY, SAFIERY, MTA...



11 AÑOS DE GARANTÍA

¡Confía en los mejores de la industria! Ofrecemos una extraordinaria garantía de 11 años, sinónimo de la máxima calidad.



ENVÍO RÁPIDO Y GARANTÍA

Nuestras baterías están siempre listas para ser reparadas/reemplazadas y entregadas rápidamente en toda Italia.



CLIENTES SATISFECHOS

Solo vendemos baterías LiFePO₄ desde 2015 y tenemos clientes 100% satisfechos en todo el mundo.



LA MEJOR ASISTENCIA

Expertos a tu servicio: estamos listos para brindarte el mejor asesoramiento de la industria para sistemas completos de baterías de litio.

LOS MEJORES patrocinadores LA BANDA DEL LITIO



LITHIUM BAND tiene más de 1 millón de seguidores en Internet.

¡Son nuestro orgullo!

**YouTubers, Influencers y Profesionales que llevan años usando
nuestras baterías.**

Nuestros clientes

BARCHELETTTRICHE SRL



Barchelettriche Srl es líder italiano en movilidad eléctrica sobre el agua, gracias a la provisión de sus propias embarcaciones y de las de otros astilleros, cuidadosamente electrificadas por BE, dirigidas a las Áreas Marinas Protegidas italianas y a los operadores económicos que trabajan en nuestros lagos, ríos y en el mar. Con modelos como el Best 6.0, accesible también para personas con discapacidades motoras, Pontoon Boat de 5 a 8,5 metros para excursiones turísticas de snorkel o recorridos por ríos y lagos, con la Breeze 820 para buceo y Áreas Marinas Protegidas, y con la introducción de nuevos modelos como el bote inflable eléctrico Stream para placer o trabajo y el típico gozzo ligure con propulsión eléctrica, Barchelettriche está convencida de poder satisfacer cualquier solicitud de embarcación eléctrica o de embarcación a electrificar.

Nuestros clientes
BARCHELETTRICHE SRL



48V 200Ah + Cargador 3000W + Converter 48V/12V

Schema e precio kit Pag. 110



LAS VENTAJAS DE LAS BATERIAS LITIO-HIERRO-FOSFATO



AHORRO DE PESO Y ESPACIO

70% de ahorro en términos de peso



PROFUNDIDAD DE DESCARGA 100% REAL

Una batería de litio de 100 Ah puede reemplazar dos baterías de plomo-ácido de 100 Ah.



ESPERANZA DE VIDA

Después de 3000 ciclos todavía tienen el 80% profundidad de descarga. Baterías de plomo ácido máx. 300/600 ciclos.



MANTENIMIENTO CERO

No deben mantenerse cargados. Baja Autodescarga <2% mensual. Sin efecto memoria.



MÁS RESPETO POR EL MEDIO AMBIENTE

Las baterías LiFePO₄ se encuentran entre las baterías más limpio y seguro del mercado. También vendemos supercondensadores y los más nuevos baterías de sodio.



ALTO RENDIMIENTO

Alta eficiencia. Carga más rápida. Mantienen un voltaje alto y constante hasta casi la descarga total.

LAS BATERÍAS DE LITIO CUESTAN MENOS DE LAS BATERÍAS DE PLOMO ÁCIDO

	BATERÍAS DE PLOMO-ÁCIDO GEL AGM	BATERÍA LIFEPO4
Capacidad instalada	2 kWh (2 x 12 V 100 Ah)	1,28 kWh (1x12V 100Ah)
Capacidad utilizable	1 kWh (30/50% profundidad de descarga)	1,28 kWh (100% profundidad de descarga)
Costo inicial	400€ (2x200€)	499€ (1 x 499€)
Esperanza de vida	500 ciclos con 50% de profundidad de descarga	5000 ciclos al 50 % de profundidad de descarga (o más de 3000 ciclos al 80 % de profundidad de descarga)
Reemplazos a realizar	diez	1
Costo total	4000€ (10x400€)	499€ (1 x 499€)
Precio por kWh utilizable (coste/ciclos/kWh)	0,8€ (4000/5000/1)	0,10€ (500/5000/1)

APLICACIONES



Visita el sitio [HTTPS://LITIO.TIENDA](https://LITIO.TIENDA)

NÁUTICO



CAMPER



GOLF CAR



CARRETILLAS
ELEVADORAS



VEHÍCULOS
PERSONALES



CCTV, RADIO, +



CASA



LE NOSTRE BATTERIE LITIO-FERRO-FOSFATO



[HTTPS://LITIO.TIENDA](https://litio.tienda)

PRO EVs



STARTER



GHOST



BLUETOOTH



ULTRASLIM



LITTLE



CLASSIC



Serie CLASSIC

Código	Producto	Corriente de carga (A)	Corriente de descarga (A)	Corriente de descarga CCA (3s)	Medidas mm (LxWxH)	Peso (kg)	Energía nominal (Wh)	Serie Max
LS1207C	12V 12Ah	4	15	30	151x98x95	1.7	153	24V
LS1218C	12V 18Ah	10	20	40	181x76x166	2.7	230	24V
LS1250C	12V 50Ah	25	50	100	230x138x222	7	691	24V
LS12100C	12V 100Ah	50	100	200	330x170x220	11	1280	48V
LS12100CS	12V 100Ah sottosedile	50	100	200	355x170x190	11	1280	48V
LS12200C	12V 200Ah	100	200	300	523x238x220	23	2560	48V
LS2450C	24V 50Ah	25	100	200	330x170x220	12	1280	24V
LS24100C	24V 100Ah	50	100	200	523*238*220	23	2560	48V
LS3650C	36V 50Ah	50	100	100	330x170x220	17	1920	36V

SERIE CLASSIC LITIO.STORE DESDE 2015



Las baterías de la Serie CLASSIC son las que nos han llevado hasta donde estamos hoy.
Miles de clientes las utilizan en toda Europa desde hace casi 10 años.
¡El mejor relación calidad/precio del mundo!

SERIE CLASSIC

Serie CLASSIC



PRODUCT CODE: #LS1207C

12V 7Ah 153Wh

€ 89,90



PRODUCT CODE: #LS1218C

12V 18Ah 230Wh

€ 109,90



PRODUCT CODE: #LS1250C

12V 50Ah 691Wh

€ 299,90



PRODUCT CODE: #LS12100C

12V 100Ah 1280Wh

€ 499,90



PRODUCT CODE: #LS12100CS

12V 100Ah 1280Wh

SOTTOSEDILE CAMPER/VAN

€ 549,90



PRODUCT CODE: #LS12200C

12V 200Ah 2560Wh

€ 999,90



PRODUCT CODE: #LS2450C

24V 50Ah 1280Wh

€ 499,90



PRODUCT CODE: #LS24100C

24V 100Ah 2560Wh

€ 999,90



PRODUCT CODE: #LS3650C

36V 50Ah 1920Wh

€ 1299,90

Serie BLUETOOTH

Código	Producto	Corriente de carga (A)	Corriente de descarga (A)	Corriente de descarga CCA (3s)	Medidas mm (LxWxH)	Peso (kg)	Energía nominal (Wh)	Bluetooth	Serie Max
LS12100B	12V 100Ah	100	150	500	330x170x220	11,5	1280	Sì	48V
LS12150BS	12V 150Ah	100	150	350	355x170x190	17	1920	Sì	48V
LS12200B	12V 200Ah	100	200	600	525x240x220	23	2560	Sì	48V
LS12280BS	12V 280Ah sottosedile	140	200	600	355x190x330	28	3584	Sì	12V
LS12560B	12V 560Ah	200	200	600	440x300x375	56	7168	Sì	12V
LS2450B	24V 50Ah	25	100	300	330x170x220	11,5	1280	Sì	48V
LS24100B	24V 100Ah	50	100	300	525x240x220	23	2560	Sì	48V
LS3678B	36V 78Ah	50	100	300	525x240x220	25	2998	Sì	36V
LS36100B	36V 100Ah	50	100	500	525x240x220	29	3840	Sì	36V

APP BLUETOOTH EN ESPAÑOL DE LITIO STORE

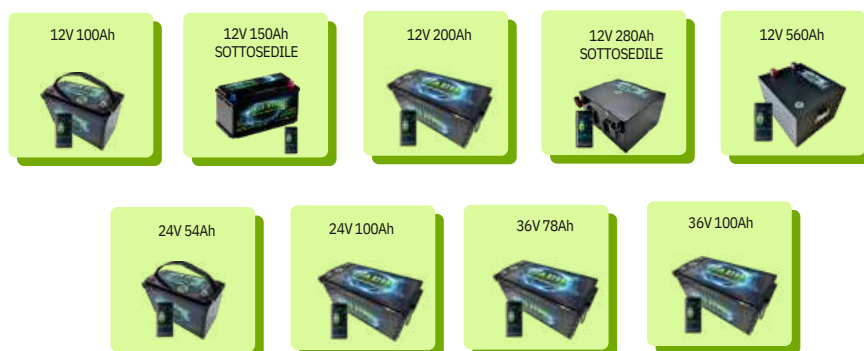

Nuestra app en italiano LITIO STORE muestra el estado de carga de la batería, los consumos instantáneos, el estado de las celdas, el historial de la batería e integra funciones útiles como un desconector de batería remoto.

SERIE BLUETOOTH

Serie BLUETOOTH



PRODUCT CODE: #LS120100B

12V 100Ah 1280Wh

€ 699,90



PRODUCT CODE: #LS12150B

12V 150Ah 1920Wh

SOTTOSEDILE CAMPER/VAN

€ 899,90



PRODUCT CODE: #LS12200B

12V 200Ah 2560Wh

€ 1299,90



PRODUCT CODE: #LS12280B

12V 280Ah 3584Wh

€ 1699,90



PRODUCT CODE: #LS12560B

12V 560Ah 7168Wh

€ 3299,90



PRODUCT CODE: #LS2450B

24V 50Ah 1280Wh

€ 749,90



PRODUCT CODE: #LS24100B

24V 100Ah 2560Wh

€ 1299,90



PRODUCT CODE: #LS3678B

36V 78Ah 2998Wh

€ 1799,90



PRODUCT CODE: #LS36100B

36V 100Ah 3840Wh

€ 1999,90

Serie LITTLE

Código	Producto	Corriente de carga (A)	Corriente de descarga (A)	Corriente de descarga CCA (3s)	Medidas mm (LxWxH)	Peso (kg)	Energía nominal (Wh)	Serie Max
LS12100P	12V 100Ah	100	100	200	260x133x228	9,6	1280	48V
LS12190P	12V 190Ah	150	200	1800	330x170x220	19	2432	48V
LS12300P	12V 300Ah	100	100	100	483x170x220	32	3840	24V
LS12300PS	12V 300Ah sottosedile	75	200	400	340x248x190	26	3840	48V
LS12400P	12V 400Ah	125	250	1400	523x270x220	40	5120	48V
LS12500PS	12V 500Ah sottosedile	250	300	600	360x365x190	42,5	6400	48V
LS24200P	24V 200Ah	100	200	400	523x270x220	40	5120	48V
LS48100P	48V 100Ah	50	100	200	523x270x220	42	5120	48V
LS48200P Comun. CAN per Inverter	48V 200Ah	100	100	100	500X445X244	81	9600	48V

LAS BATERIAS LIFEPO4 MAS PEQUEÑAS DEL MUNDO



Difícilmente encontrarás baterías de litio-hierro-fosfato más pequeñas que estas.

En la caja de 100Ah, ahora hay 190Ah.

En la caja de 150Ah, hay 300Ah.

En la caja de 200Ah, hay 400Ah.

¡Debajo del asiento del Ducato puedes poner hasta 500Ah!

SERIE PICCOLA

Serie LITTLE



PRODUCT CODE: #LS12100P

12V 100Ah 1280Wh

€ 649,90



PRODUCT CODE: #LS12190P

12V 190Ah 2432Wh

€ 1299,90



PRODUCT CODE: #LS12300P

12V 300Ah 3480Wh

€ 1599,90



PRODUCT CODE: #LS12500PS

12V 300Ah 6400Wh

SOTTOSEDILE CAMPER/VAN

€ 2199,90



PRODUCT CODE: #LS12400P

12V 400Ah 5120Wh

€ 2199,90



PRODUCT CODE: #LS12500PS

12V 500Ah 6400Wh

SOTTOSEDILE CAMPER/VAN

€ 4399,90



PRODUCT CODE: #LS24200P

24V 200Ah 5120Wh

€ 2199,90



PRODUCT CODE: #LS48100P

48V 100Ah 5120Wh

€ 2799,90



PRODUCT CODE: #LS48200P

48V 200Ah 9600Wh

CAN + COMPATIBILITÀ INVERTER

€ 3499,90

Serie GHOST

Código	Producto	Corriente de carga (A)	Corriente de descarga (A)	Corriente de descarga CCA (3s)	Medidas mm (LxWxH)	Peso (kg)	Energía nominal (Wh)	Serie Max
LS12100G	12V 100Ah	50	100	200	360x190x220	12	1280	48V
LS12145G	12V 145Ah	75	150	300	360x190x220	15	1856	48V
LS12200G	12V 200Ah	100	200	300	525x245x220	23	2560	24V
LS2450G	24V 50Ah	25	50	100	360x190x220	12	1280	48V
LS24100G	24V 100Ah	50	100	200	525x245x220	23	2560	48V



APLICACIÓN BLUETOOTH EN IDIOMA INGLÉS

VE LO QUE LOS DEMAS NO PUEDEN VER



Un producto único y espectacular en el mercado europeo. Una manufactura excelente con soldaduras láser, las cajas y los soportes internos de metal han sido diseñados y producidos especialmente para esta serie de baterías.

SERIE GHOST

Serie GHOST



PRODUCT CODE: #LS12100G

12V 100Ah 1280Wh

€ 699,90



PRODUCT CODE: #LS12145G

12V 145Ah 1856Wh

€ 949,90



PRODUCT CODE: #LS112200G

12V 200Ah 2560Wh

€ 1399,90



PRODUCT CODE: #LS2450G

24V 50Ah 1280Wh

€ 749,90



PRODUCT CODE: #LS24100G

24V 100Ah 2560Wh

€ 1399,90

Serie ULTRASLIM

Código	Producto	Corriente de carga (A)	Corriente de descarga (A)	Corriente de descarga CCA (3s)	Medidas mm (LxWxH)	Peso (kg)	Energía nominal (Wh)	Serie Max
LS12100U	12V 100Ah	50	100	200	395x110x285	11,5	1280	48V
LS12100UM	12V 100Ah	50	100	200	710x60x270	16	1280	48V
LS12200U	12V 200Ah	50	100	200	557x124x317	22	2560	48V
LS12200UM	12V 200Ah	100	200	350	400x120x300	24	2560	48V
LS2450U	24V 50Ah	25	50	100	395x110x285	11,5	1280	48V
LS24100U	24V 100Ah	50	100	200	557x124x317	24	2560	48V



APLICACIÓN BLUETOOTH EN IDIOMA INGLÉS

LAS BATERIAS LIFEPO4 MAS DELGADAS DEL MUNDO



Instala las baterías UltraSlim donde otras baterías no pueden ser instaladas. ¡La 12V 100Ah en metal tiene solo 6 cm de ancho!

Otra serie de baterías de litio-hierro-fosfato que solo puedes encontrar en Lito.Store

SERIE ULTRASLIM

Serie ULTRASLIM

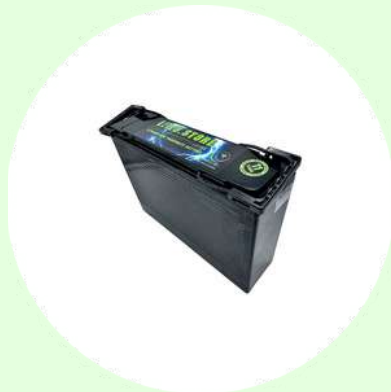

PRODUCT CODE: #LS12100U

12V 100Ah 1280Wh

€ 749,90



PRODUCT CODE: #LS12100UM

12V 100Ah 1280Wh

ESPESOR 6mm

€ 849,90



PRODUCT CODE: #LS12200U

12V 200Ah 2560Wh

€ 1399,90



PRODUCT CODE: #LS12200UM

12V 200Ah 2560Wh

€ 1449,90



PRODUCT CODE: #LS2450U

24V 50Ah 1280Wh

€ 749,90



PRODUCT CODE: #LS24100U

24V 100Ah 2560Wh

€ 1449,90

Serie ULTRASLIM



PRODUCT CODE: #LS12200UM

12V 200Ah 2560Wh

€ 1449,90

Serie STARTER

Código	Producto	Corriente de descarga (A)	Corriente de descarga CCA (3s)	Medidas mm (LxWxH)	Peso (kg)	Energía nominal (Wh)	Serie Max
LS1218S	12V 18Ah	40	600	240x174x190	3,5	230	24V
LS1236S	12V 36Ah	80	1000	240x174x190	5,6	460	24V
LS1255S	12V 55Ah	120	1500	278x174x190	7,8	704	24V
LS1278S	12V 78Ah	160	1800	315x174x190	12,2	998	24V
LS12105S	12V 105Ah	240	2200	355x174x190	14,4	1344	24V

LAS UNICAS BATERIAS DE ARRANQUE LIFEPO4



BMS activo: las baterías LiFePO4 con BMS pasivo tienen una vida útil más corta si se someten frecuentemente a descargas intensas, como el arranque de un motor. El BMS activo se encarga de mantener las celdas equilibradas.

Sobrevoltaje 15.6V | Por lo general, los BMS de las baterías LiFePO4 tienen el sobrevoltaje a 14.8V, lo que las hace incompatibles con algunos alternadores y cargadores.

CCA 600-2200A

Arranque rapido desde -20°C

Funcionamiento hasta +90°C

SERIE STARTER

Serie STARTER



PRODUCT CODE: #LS1218S

12V 18Ah 230Wh
CCA 600A PB EQUIV. 45AH
€ 799,90



PRODUCT CODE: #LS1236S

12V 36Ah 460Wh
CCA 1000A PB EQUIV. 90AH
€ 999,90



PRODUCT CODE: #LS1255S

12V 55Ah 704Wh
CCA 1500A PB EQUIV. 125AH
€ 1249,90



PRODUCT CODE: #LS1278S

12V 78Ah 998Wh
CCA 1800A PB EQUIV. 180AH
€ 1499,90

Serie PRO EVs

Corriente de carga (A)	Serie Max	Corriente de descarga CCA (3s)	Medidas mm (LxWxH)	Peso (kg)	Energía nominal (Wh)	Corriente de carga (A)	Corriente de descarga (A)
48v 32Ah	48V	30	100	200	260x180x266	16	1638
48V 100Ah 20 giorni	96V	50	125	200	510x350x260	52	5120
48V 105Ah 2-3 mesi	48V	100	200	500	487x300x215	51	5376
48V 200Ah	96V	100	200	250	600x420x240	75	10240
48V 300Ah	48V	100	200	500	650x420x420	118	15360
96V 50Ah	96V	50	100	200	561x491x202	67	4800
96V 100Ah	96V	50	100	200	891x441x202 / 762x558x245	102	9600
96V 200Ah	96V	200	200	400	940x540x272	140	19200
96V 280Ah	96V	100	200	250	988x639x271	189	26880
96V 400Ah	96V	100	200	250	938x1078x270	260	38400



WATERPROOF IP65/67

**LAS MEJORES BATERIAS LIFEPO4 PARA
MOTORES ELECTRICOS
36V – 96V**

SERIE PRO

Serie PRO EVs



PRODUCT CODE: #LS1232M

12V 32Ah 1638Wh

€ 1299,90



PRODUCT CODE: #LS48100M

48V 100Ah 5120Wh

MAX 2 SERIE 96V

€ 3999,90



PRODUCT CODE: #LS48105M

12V 105Ah 5376Wh

€ 2999,90



PRODUCT CODE: #LS48200M

48V 200Ah 10240Wh

MAX 2 SERIE 96V

€ 6499,90



PRODUCT CODE: #LS9650M

96V 50Ah 4600Wh

€ 3299,90



PRODUCT CODE: #LS96100M

96V 100Ah 9600Wh

€ 6499,90



PRODUCT CODE: #LS96200M

96V 200Ah 19200Wh

€ 12499,90



PRODUCT CODE: #LS96280M

96V 280Ah 26880Wh

€ 15499,90



PRODUCT CODE: #LS96400M

96V 400Ah 38400Wh

€ 21999,90

Serie PRO EVs

48V 32Ah



Diseñada para carritos de golf y vehículos eléctricos, tiene características únicas que la diferencian de nuestros competidores.

- Plug-and-play: dimensiones estándar del box GC2.
- También apta para motores con recuperación de energía de frenado. El BMS de la batería NO entra en protección como las otras baterías del mercado.
- 2 baterías garantizan una autonomía de 35-50 km Descubre más en nuestro sitio web...



48V 105Ah

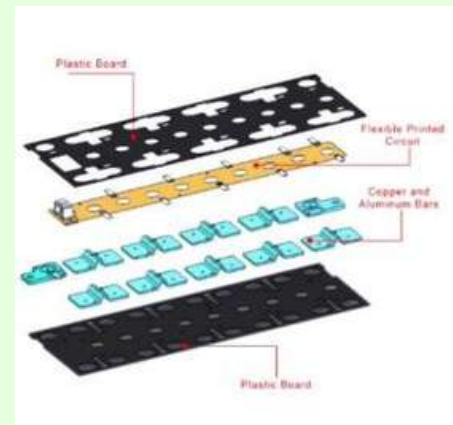

LA BATERÍA DE LITIO HIERRO FOSFATO MÁS SEGURA DEL MERCADO

Una joya de la tecnología moderna. Para esta batería hemos utilizado técnicas de ensamblaje que hasta ahora solo pertenecían al campo aeroespacial y de los vehículos eléctricos, donde se requiere la máxima seguridad.

- Arrestador de llamas interno
- CCS (Cell Connection System)
- Conexiones internas a los polos mediante busbar
- Busbars niquelados químicamente

Descubre más en nuestro sitio...

Specifiche tecniche

Lithium Iron Phosphate (LiFePO4) Battery Datasheet

Model LS12100CSS

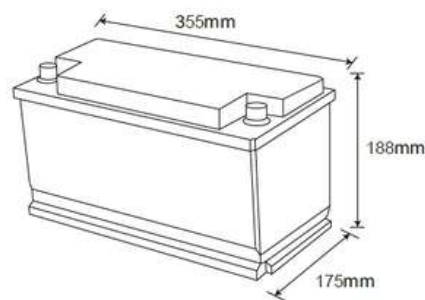

ELECTRICAL CHARACTERISTICS

Nominal Voltage	12.8V
Nominal Capacity	100Ah
Energy	1280Wh
Cycle Life	>3000 cycles @80%DOD >6000 cycles @50%DOD
Internal Resistance	≤20mΩ
Charge Efficiency	100% @0.5C
Discharge Efficiency	96~99% @1C
Self Discharge Rate	<3% per month

CHARGE / DISCHARGE

Charge Voltage	14.6 Max
Rec. Charge Current	20A
Max. Charge Current	50A
Charge Mode	CC/CV
Max Continuous Discharge Current	100A
Max Peak Discharge Current	200A (300ms)
Discharge Cut-off Voltage	10.5V

ENVIRONMENTAL @60±25% Relative Humidity

Charge Temperature	0°C ~ 45°C (32F ~ 113F)
Discharge Temp.	-20°C ~ 60°C (-4F ~ 140F)
Storage Temp.	0°C ~ 40°C (32F ~ 104F)

MECHANICAL

Battery Case	ABS
Dimensions (mm)	355x176x187mm
Weight (kg)	11kg
Waterproof rating	IP65
Terminals	M8

LITIO.STORE WARRANTY

Warranty 11 years

[HTTPS://LITIO.STORE](https://litio.store)

LITIO STORE SRL
VAT Nr.: IT-03894170541, Telefono: +39 3884463884
Via G.Matteotti, 4B (sede legale: via Giotto, 2) - 06028 - Sigillo (PG) Italy
Iscrizione al Registro Pile e Accumulatori IT21020P00006758

Seguridad: BMS incluido

Sistema de Gestión de Baterías incluido en todas nuestras baterías

Las baterías de fosfato de hierro y litio se encuentran entre las más seguras del mercado.

El mismo tipo de baterías de litio que hoy en día se instalan en nuestros hogares. Son las preferidas en los hogares precisamente por su seguridad, porque este tipo de baterías de litio (fosfato de litio y hierro LiFePO_4) no se inflaman, no se inflaman, no se inflaman ni explotan.

Todas nuestras baterías están equipadas con el dispositivo BMS, que monitorea constantemente los parámetros de la batería, incluido temperatura, cortocircuito, corrientes, tensiones, equilibrado.



Entonces, ¿por qué vemos coches incendiados por culpa de baterías de litio?

Porque hasta hace poco las baterías de litio LiFePO_4 NO se utilizaban en coches eléctricos. En su lugar, se utilizaron otro tipo de baterías de litio, las mismas que se utilizan en vehículos eléctricos ligeros como scooters, bicicletas eléctricas y drones.

Respecto a los incendios, con baterías LiFePO_4 de excelente calidad (y con un sistema eléctrico ad-hoc) ¡no tienes nada que temer!

Certificaciones CE ROHS EN UN38.3

ACCESORIOS PARA BATERÍA LiFePO4

LAS MEJORES MARCAS

Recarga con alternador



Recarga con paneles solares



Recarga con red de 220V

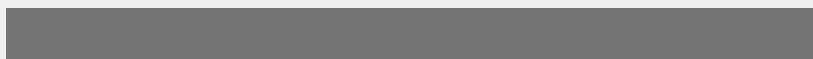

Monitor de batería



Inversor



Convertidor CC-CC



Recarga con ALTERNADOR



Accesorio recomendado: CARGADOR DC-DC

Las baterías de litio se pueden recargar rápidamente mediante el motor de combustión interna mientras se está en movimiento.

NO debe conectar la batería de litio directamente al alternador ni a la batería del motor de plomo-ácido, corre el riesgo de dañar el alternador (porque la batería de litio consume mucha más corriente que la batería de plomo-ácido) y acortar la vida útil de la batería de litio (porque hay no hay una curva de carga adecuada).



El accesorio necesario es un cargador de batería DC-DC específico para baterías LiFePO₄. Convierte el voltaje recibido del alternador en el voltaje adecuado para cargar baterías de fosfato de hierro y litio LiFePO₄.

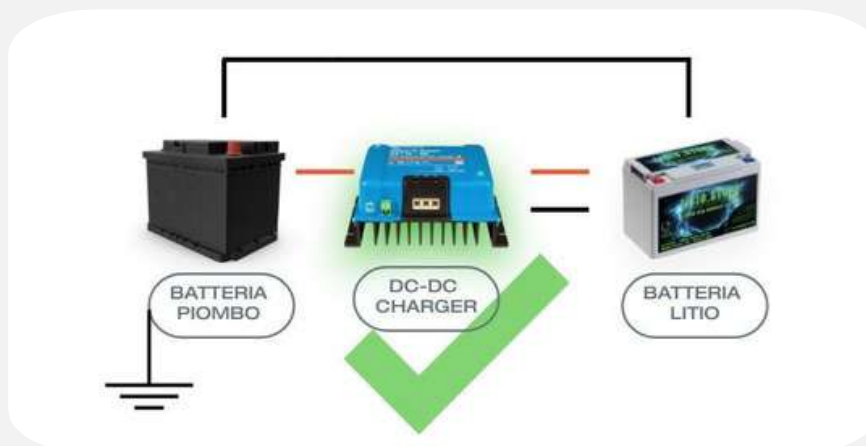

Recarga con ALTERNADOR



CONSEJOS ÚTILES

En el caso de una autocaravana o embarcación, con sistema eléctrico existente, es necesario desconectar del alternador cualquier paralelizador, booster o accesorio que se encargue de la carga, si no es apto para baterías LiFePO₄.

En su lugar se debe insertar un cargador DC-DC con una potencia no mayor a la mitad de la potencia del alternador.

Ejemplo: alternador de 80A, 30-40A CC-CC.

Lo más probable es que sea necesario utilizar cables de mayor sección.

En nuestra web encontrará una CALCULADORA para calcular la sección del cable.

CONSEJO

En Italia hay muy pocas personas competentes en sistemas de litio en barcos y autocaravanas. Confíe en los expertos: ¡solo vendemos baterías LiFePO₄ desde 2015!

Hemos visto problemas y soluciones y todas tus preguntas tendrán respuesta.

Compra accesorios con nosotros, vendemos las mejores marcas.

Te ayudamos con el diseño, instalación y configuración.

También ofrecemos soluciones completas todo en uno para sistemas eléctricos de embarcaciones.

Contamos con un asesor técnico experto que instala baterías de litio todos los días como trabajo.

No dude en contactarnos para cualquier información.

Recarga con ALTERNADOR



VICTRON ENERGY



Empresa
HOLANDESA

Descargar
LISTA DE PRECIOS
Victron actualizado

Recarga con ALTERNADOR



VICTRON ENERGY



Fácilmente programable vía BLUETOOTH



CODICE LITIO STORE: #LS-DC-V121218I

CODICE PRODUTTORE: #ORI121222120

Orion-Tr Smart
12/12-30A Non-Isolated
€ 208,62



CODICE LITIO STORE: #LS-DC-V121230N

CODICE PRODUTTORE: #ORI121236140

Orion-Tr Smart
12/12-30A Non-Isolated
€ 280,60



CODICE LITIO STORE: #LS-DC-V121250XS

CODICE PRODUTTORE: #ORI121217040

Orion XS
12/12-50A
€ 427,00



CODICE LITIO STORE: #LS-DC-V121218I

CODICE PRODUTTORE: #ORI122436120

Orion-Tr Smart
12/24-15A Non-Isolated
€ 280,60



CODICE LITIO STORE: #LS-DC-V121230N

CODICE PRODUTTORE: #ORI241236140

Orion-Tr Smart
24/12-30A Non-Isolated
€ 280,60



CODICE LITIO STORE: #LS-DC-V121230N

CODICE PRODUTTORE: #ORI242440140

Orion-Tr Smart
24/24-17A Non-Isolated
€ 280,60

Recarga con ALTERNADOR



STERLING POWER



Empresa
INGLESA



CODICE LITIO STORE: #LS-DC-SP121270

CODICE PRODUTTORE: #BB121270

**Battery to Battery
charger 12/12-70A**
€ 569,00



CODICE LITIO STORE: #LS-DC-SP123670

CODICE PRODUTTORE: #BB123670

**Battery to Battery
charger 12/36-70A**
€ 549,00

Recarga con ALTERNADOR y PANELES SOLARES



REDARC



Empresa
AUSTRALIANA



MPPT & DC-DC



MPPT & DC-DC

Max INPUT: 32V

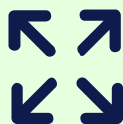

Pequeño



Instalación rápida



Versiones impermeables

Recarga con ALTERNADOR y PANELES SOLARES



REDARC

Recarga con ALTERNADOR y PANELES SOLARES

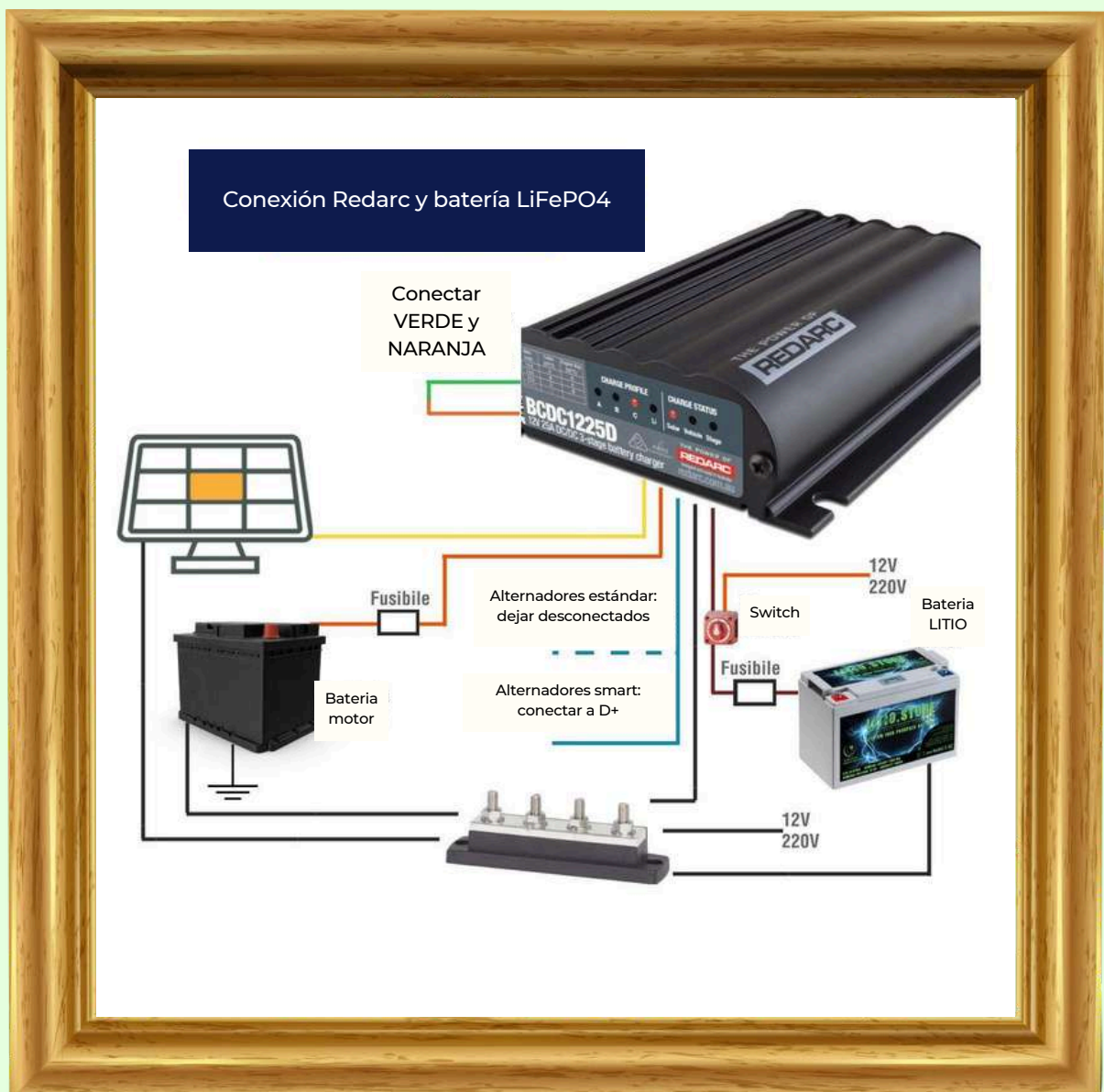

Recarga con ALTERNADOR y PANELES SOLARES



REDARC

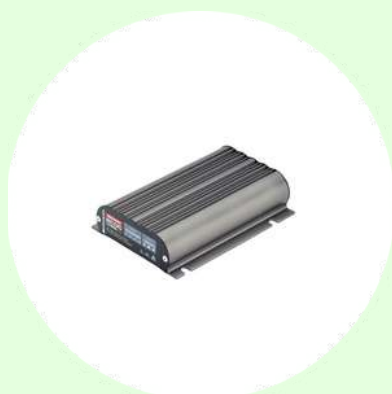

CODICE LITIO STORE: #LS-DC-R1225N

CODICE PRODUTTORE: #BCDCN1225

Redarc BCDCN1225

€ 449,90

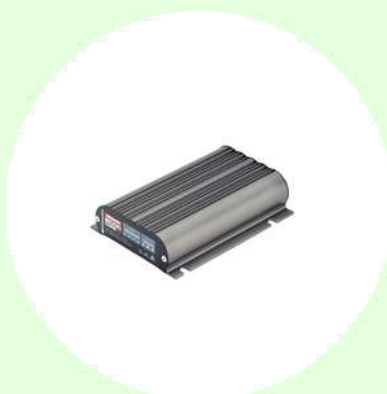

CODICE LITIO STORE: #LS-DC-R1240N

CODICE PRODUTTORE: #BCDCN1240

Redarc BCDCN1240

€ 499,90



CODICE PRODUTTORE: #BCDC1225D

CODICE PRODUTTORE: #ORI121217040

Redarc BCDC1225D

WATERPROOF IP67

€ 549,90



CODICE LITIO STORE: #LS-DC-R1240D

CODICE PRODUTTORE: #BCDC1240D

Redarc BCDC1240D

WATERPROOF IP67

€ 649,90



CODICE LITIO STORE: #LS-DC-R1250D

CODICE PRODUTTORE: #BCDC1250D

Redarc BCDC1250D

WATERPROOF IP67

€ 699,90

Recarga con
ALTERNADOR



SAFIERY SCOTTY AI



Empresa
AUSTRALIANA



**DC-DC Bidireccional
3000W IP66**

Recarga con ALTERNADOR



SEGURIDAD SCOTTY AI



Velocidad de carga

Recarga a una velocidad nunca antes vista, hasta 250A desde uno Alternador de 12V.

Seguridad

No daña el alternador. comprobar la temperatura. también puedes elegir la velocidad (dura, media y suave).

DC-DC Bidireccional

Este innovador producto, además de recargar las baterías, da servicio a un 24,36,48V, también es capaz de dar energía a usuarios de 12V.

Ejemplo útil:

Si un cabrestante consume 360 A, se extraerán 180 A del alternador y 180 A de las baterías de servicio.

Resistente al agua IP66

Se puede instalar en el compartimento del motor. Pero un dc-Sin embargo, debe instalarse lo más cerca posible de la batería de servicio para evitar caídas de tensión.

Somos uno de los pocos distribuidores oficiales de Safiery en Europa.

Recarga con
ALTERNADOR



SAFIERY SCOTTY AI



**RICARICA
DA ALTERNATORE
FINO A 250A**

Scotty 1500W 12V-24/36/48V IP65	€1549,90
Scotty 1500W 12V-24/36/48V IP66	€1749,90
Scotty 3000W 12V-24/36/48V IP64S	€2799,90
Scotty 3000W 12V-24/36/48V IP66	€2990,90
Scotty 3000W 24V-36/48V IP64S	€3099,90
Scotty 3000W 24V-36/48V IP66	€3299,90

Recarga con ALTERNADOR



SAFIERY SCOTTY AI Sistema completo 24/36/48V

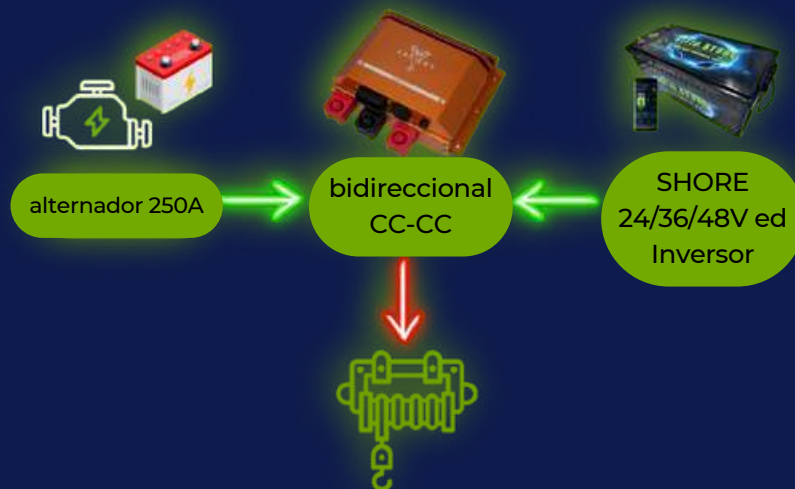
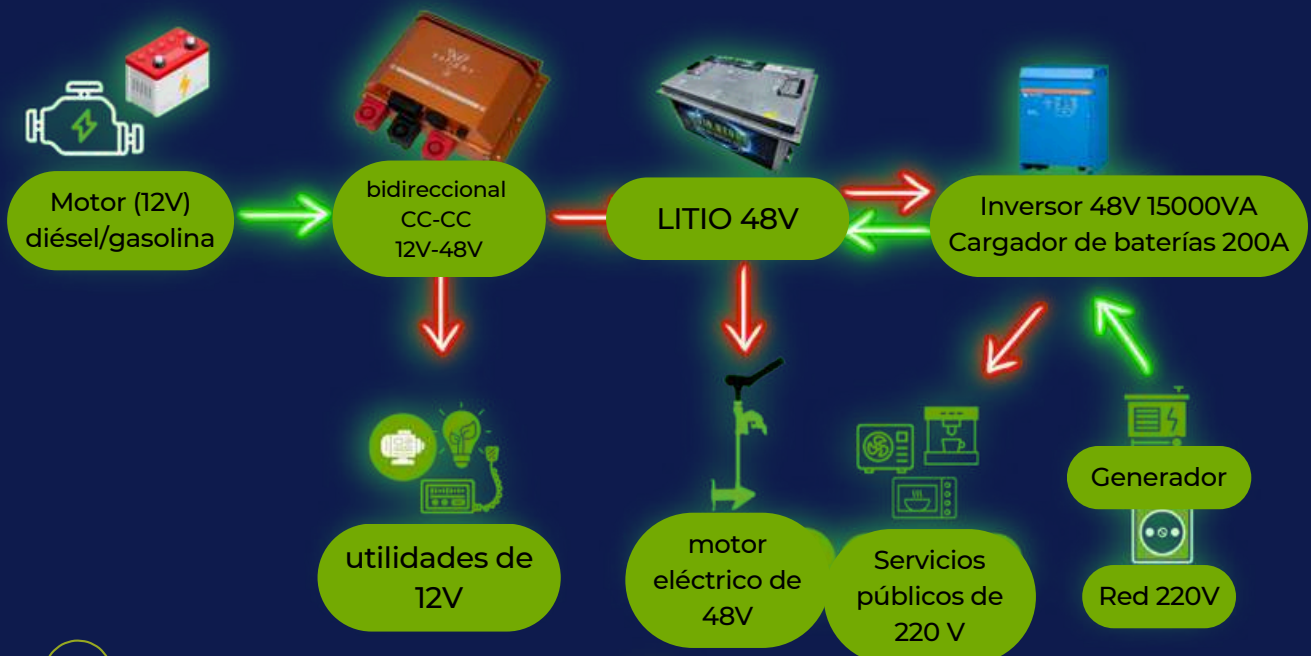

SI UN CABRESTANTE CONSUME 360A, 180A SON TOMADOS DEL ALTERNADOR Y 180A DE LAS BATERÍAS DE SERVICIO.

Recarga con
ALTERNADOR y
PANELES SOLARES



MPPT & DC-DC

LITIO STORE
SunDrive Pro
MPPT & DC-DC
charger 25A

Recarga con ALTERNADOR y
PANELES SOLARES



Empresa
ITALIANA

Recarga con
ALTERNADOR y
PANELES SOLARES



LITIO STORE

SunDrive Pro 25A



279,90€



39,90€

Monitor

CÓDIGO DE PRODUCTO: #LS-DC-SDP25



Potencia máxima de entrada solar 450 W/900 W
Voltaje máximo de entrada solar 60 V

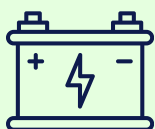

Batería de motor de 12V/24V. Batería de servicio de 12V/24V.



Instalación rápida



Bluetooth

Recarga con
ALTERNADOR y
PANELES SOLARES



LITIO STORE

SunDrive Pro 25A



Recarga con
ALTERNADOR y
PANELES SOLARES



LITIO STORE

SunDrive Pro 25A

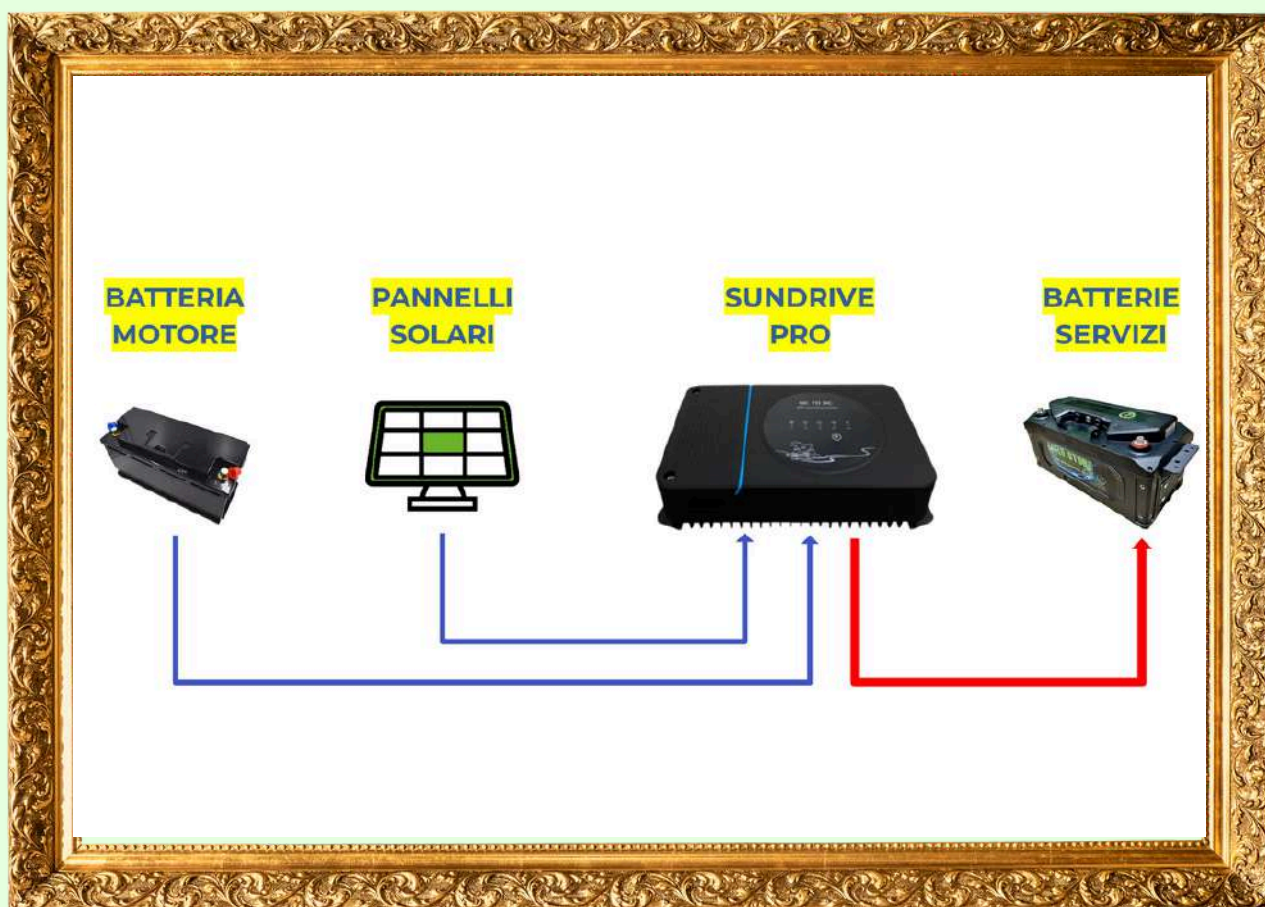

RECARGA CON ALTERNADOR



NO NECESITAN MANTENERSE COMPLETAMENTE CARGADOS

Es obligatorio un controlador de carga específico para baterías LifePO₄, quizás programable como Victron SmartSolar o nuestros controladores de carga Lithium Store.

Las baterías de plomo ácido siempre deben permanecer completamente cargadas. Las baterías de litio, en cambio, duran menos si siempre permanecen al 100% de carga, especialmente cuando no están en uso.

Durante los períodos de inactividad, recomendamos utilizar un INTERRUPTOR DE BATERÍA para eliminar el consumo de batería y evitar tener las baterías de litio en constante recarga.

La autodescarga de las baterías de litio es inferior al 3% mensual. Una batería al 70% puede permanecer estacionaria durante más de 2 años sin absorción.

Si tienes que dejar el sistema encendido todo el tiempo, es aún más recomendable un regulador de carga programable para bajar el voltaje de mantenimiento.

Con las baterías de litio también se podría pensar en eliminar el panel solar y recargar la batería únicamente mediante alternador y por tanto cargador DC-DC. O quizás podrías llevarte la batería ya cargada (recargada en casa con el cargador de red de 220V) y no recargarla nunca ni recargarla, para salidas cortas.

Escenarios impensables con baterías de plomo, que debían permanecer siempre completamente cargadas, por lo que era imprescindible al menos un pequeño panel solar.

Recarga con
PANELES SOLARES



VICTRON ENERGY



Agencia
HOLANDÉS

Descargue la LISTA
DE PRECIOS Victron
actualizada

Recarga con PANELES SOLARES



VICTRON ENERGY



Programmabile facilmente tramite **BLUETOOTH**



CODICE LITIO STORE: #LS-RC-VS7515

CODICE PRODUTTORE: #SCC075015060R

SmartSolar 75|15
(Max. 75V Input, 15A Out)

€ 87,84



CODICE LITIO STORE: #LS-RC-VS10020

CODICE PRODUTTORE: #SCC110020160R

SmartSolar 100|20

Fino a 48V

€ 117,12



CODICE LITIO STORE: #LS-RC-VS10030

CODICE PRODUTTORE: #SCC110030210

SmartSolar 100|30

€ 167,14



CODICE LITIO STORE: #LS-RC-VS10030

CODICE PRODUTTORE: #SCC110050210

SmartSolar 100|50

€ 240,34



CODICE LITIO STORE: #LS-DC-V121230N

CODICE PRODUTTORE: #ORI241236140

SmartSolar 150|60

€ 457,50



CODICE LITIO STORE: #LS-RC-VSE548500

CODICE PRODUTTORE: #PMP482507010

EasySolar-II 48/5000/70-50 MPPT 250/100 GX

€ 2565,66

Recarga con
PANELES SOLARES



MPPT max. 150V Input

LITIO STORE
Solar Force
150-20 150-40
MPPT charger



Empresa
ITALIANA

Recarga con
PANELES SOLARES



LITIO STORE

Solar Force



Fácilmente programable vía BLUETOOTH



Pantalla táctil de vidrio templado



PRODUCT CODE: #LS-SOF-15020

Litio Store
Solar Force 150-20
€ 139,90



PRODUCT CODE: #LS-SOF-15030

Litio Store
Solar Force 150-30
€ 179,90



PRODUCT CODE: #LS-SOF-15040

Litio Store
Solar Force 150-40
€ 199,90

Recarga con
PANELES SOLARES



MPPT oppure DC-DC

LITIO STORE
Solar Boost 4820
MPPT o DC-DC
charger

Recarga con ALTERNADOR o PANELES SOLARES



Empresa
ITALIANA

Recarga con
PANELES SOLARES



LITIO STORE

Solar Boost 4820



€ 159,90

PRODUCT CODE: #LS-DC-SOB4820



€ 39,90

Monitor



Potencia máxima de entrada solar 300W (12V) / 1200W (48V)
Voltaje máximo de entrada solar 150 V

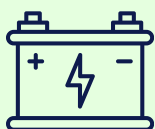

Batería de motor de 12V/24/36/48V
Batería de servicio de 12V/24/36/48V



Instalación rápida

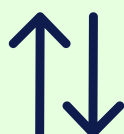

MPPT Buck-Boost

Recarga con
PANELES SOLARES



LITIO STORE
Solar Pocket 1210
Solar Pocket 2420
MPPT charger

Regulador de carga solar MPPT portable



Empresa
ITALIANA

Recarga con
PANELES SOLARES



LITIO STORE

Solar Pocket 1210



€ 79,90

PRODUCT CODE: #LS-DC-SOP1210



Potencia máxima de entrada solar 150W
Voltaje máximo de entrada solar 30 V

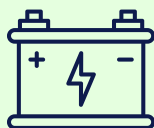

Batería de servicio de 12V



Corriente 10A

Recarga con
PANELES SOLARES



LITIO STORE

Solar Pocket 2420



€ 99,90

PRODUCT CODE: #LS-DC-SOP2410



Potencia máxima de entrada solar 300W (12V) / 600W (24V)
Voltaje máximo de entrada solar 30 V (12 V) / 60 V (24 V)

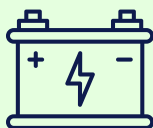

Batería de servicio de 12V/24V



Corriente 20A



SOLARFAM

The logo for SolarFAM, featuring the word "SOLARFAM" in blue capital letters with a small sun icon above the 'A'.

Empresa
HOLANDESE



SOLARFAM



CODICE LITIO STORE: #LS-PS-S100W-P

CODICE PRODUTTORE: #SZ-100-36M

100W Pieghevole

1120 x 565 x 3 mm
3 kg

€ 129,00

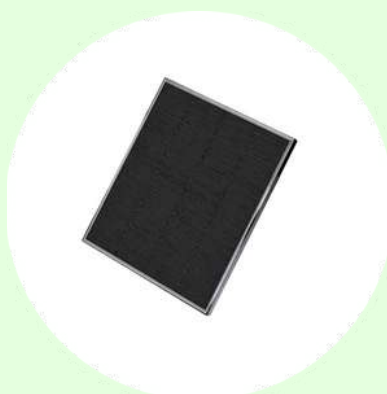

CODICE LITIO STORE: #LS-PS-S50W-R

CODICE PRODUTTORE: #SZ-50-36M

50W Rigido

565 x 451 x 30 mm
2,8 kg

€ 79,00

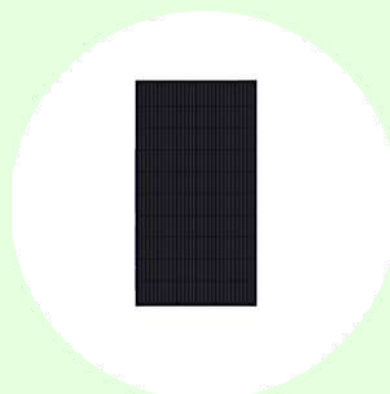

CODICE LITIO STORE: #LS-RC-VS10030

CODICE PRODUTTORE: #SCC110030210

100W Rigido

1160 x 450 x 37 mm
6 kg

€ 99,00

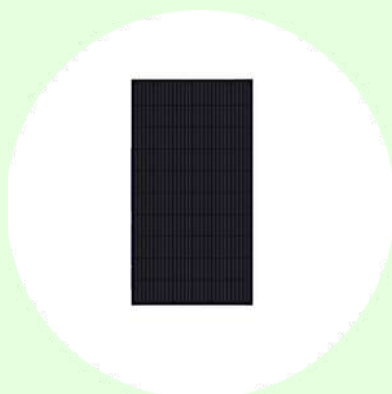

CODICE LITIO STORE: #LS-RC-VS10030

CODICE PRODUTTORE: #SCC110050210

180W Rigido

1230 x 705 x 30 mm
9 kg

€ 129,00



CODICE LITIO STORE: #LS-DC-V121230N

CODICE PRODUTTORE: #SZ-150-36MFE

150W Semi-flessibile

1240 x 670 x 2 mm
2,5 kg

€ 159,00



CODICE LITIO STORE: #LS-RC-VSES48500

CODICE PRODUTTORE: #SZ-180-36MFE

180W Semi-flessibile

1260 x 710 x 2 mm
3 kg

€ 189,00

RECARGA CON RED 220V



CARGA MUY RÁPIDA

Tenga en cuenta que, a diferencia de las baterías de plomo, las baterías de litio no necesitan ponerse al 100% inmediatamente y las nuestras se pueden descargar completamente hasta el 0% (deben recargarse en 1/2 mes).

Además, aceptan corrientes de carga elevadas y se pueden recargar en tan solo 1 o 2 horas.

Así, si tienes 3 días de autonomía con las baterías cargadas, utilizando un generador (o alternador) podrás recargar completamente las baterías en tan solo 2 horas y utilizarlas durante otros 3 días, sin tener que encender nunca el generador.

Se trata de una situación impensable en el caso de las baterías de plomo-ácido, que debían permanecer cargadas.

Los Victron Multiplus y Quattro son inversores con cargador rápido integrado. Dependiendo del modelo, cuentan con 2 entradas para 220V, que se pueden utilizar por ejemplo, una para el generador y otra para carga de la red eléctrica nacional.

Regarga con 220V



VICTRON ENERGY

Per altri inverter/caricabatterie
12V/24V/48V MULTIPLUS e QUATTRO



Descarge
LISTA DE PRECIOS
Victron actualizada

Regarga con 220V



VICTRON ENERGY MULTIPLUS



CODICE LITIO STORE: #LS-IN-VM12800

CODICE PRODUTTORE: #PMP121800000

MultiPlus 12/800/35-16

inverter 800VA

Caricabatterie 35A

€ 634,40



CODICE LITIO STORE: #LS-IN-VM121200C

CODICE PRODUTTORE: #CMP121220000

MultiPlus C 12/1200/50-16

inverter 1200VA

Caricabatterie 50A

€ 913,78



CODICE LITIO STORE: #LS-IN-VM121600C

CODICE PRODUTTORE: #CMP121620000

MultiPlus C 12/1600/70-16

inverter 1600VA

Caricabatterie 70A

€ 1024,80



CODICE LITIO STORE: #LS-IN-VM122000C

CODICE PRODUTTORE: #CMP122200000

MultiPlus C 12/2000/80-30

inverter 2000VA

Caricabatterie 80A

€ 1385,92



CODICE LITIO STORE: #LS-IN-VM123000

CODICE PRODUTTORE: #PMP122300001

MultiPlus 12/3000/120-16

inverter 3000VA

Caricabatterie 120A

€ 1712,88



CODICE LITIO STORE: #LS-IN-VM123000

CODICE PRODUTTORE: #PMP122305010

MultiPlus-II 12/3000/120-32

inverter 3000VA

Caricabatterie 120A

€ 1673,84

Regarga con 220V



VICTRON ENERGY

IP 22 / 65 / 67



CODICE LITIO STORE: #LS-CA-VIP651207

CODICE PRODUTTORE: #BPC120731064R

Blue Smart IP65 12/7

€ 145,18



CODICE LITIO STORE: #LS-CA-VIP671225

CODICE PRODUTTORE: #CMP121220000

Blue Smart IP67 12/25

€ 231,80



CODICE LITIO STORE: #LS-CA-VIP221230

CODICE PRODUTTORE: #BPC123047002

Blue Smart IP22 12/30

€ 237,90



CODICE LITIO STORE: #LS-CA-VIP652413

CODICE PRODUTTORE: #BPC241331124R

Blue Smart IP65 24/13

€ 262,30



CODICE LITIO STORE: #LS-CA-VIP672412

CODICE PRODUTTORE: #BPC241247006

Blue Smart IP67 24/12

€ 231,80



CODICE LITIO STORE: #LS-CA-VIP431250

CODICE PRODUTTORE: #PSC125051085

Phoenix Smart IP43 12/50

€ 589,26

Regarga con 220V



PRODUCT CODE: ##LS-CA-LS1210

12V 10A 140W

€ 39,90



PRODUCT CODE: ##LS-CA-LS2405

24V 5A 140W

€ 39,90



PRODUCT CODE: ##LS-CA-LS3605

36V 5A 200W

€ 49,90



PRODUCT CODE: ##LS-CA-LS1210

12V 20A 280W

€ 79,90



PRODUCT CODE: ##LS-CA-2410

24V 20A 280W

€ 79,90



PRODUCT CODE: ##LS-CA-4805

48V 5A 280W

€ 79,90



PRODUCT CODE: ##LS-CA-LS1210

48V 10A 580W

€ 179,90



PRODUCT CODE: ##LS-CA-2410

48V 10A 580W

WATERPROOF IP67

€ 279,90



PRODUCT CODE: ##LS-CA-3620

36V 20A 870W

WATERPROOF IP67

€ 329,90

Regarga con 220V



PRODUCT CODE: ##LS-CA-4823

48V 20A 1160W

WATERPROOF IP67

€ 519,90



PRODUCT CODE: ##LS-CA-4835

48V 35A 2000W

WATERPROOF IP67

€ 699,90



PRODUCT CODE: ##LS-CA-4855

48V 55A 3000W

WATERPROOF IP67

€ 1199,90



PRODUCT CODE: ##LS-CA-4885

48V 85A 5000W

WATERPROOF IP67 TRIFASE

€ 2499,90



PRODUCT CODE: ##LS-CA-LS9610

96V 10A 1000W

€ 279,90



PRODUCT CODE: ##LS-CA-LS9630

96V 30A 3000W

WATERPROOF IP65

€ 1199,90

ESTADO DE CARGA



¿Por qué utilizar un MONITOR DE BATERÍA?

Una de las ventajas de las baterías LiFePO₄ es que mantienen un voltaje constante (por encima de 13V) la mayor parte del tiempo. Esto le permite utilizar cargas elevadas durante más tiempo. Sin embargo, precisamente porque el voltaje es constante la mayor parte del tiempo, es muy difícil leer el estado de carga de las baterías LiFePO₄. Por ejemplo, una batería de plomo ácido se carga a 12,8/13,0 V (en reposo), mientras que una batería LiFePO₄ comienza a descargarse. Entre 13,0V y 13,2V se concentra aproximadamente el 70% de la capacidad total de la batería.

AGM	%	LiFePO ₄	%
13.0 (V)	100%	14.4 (V)	100%
12.75	90%	13.6	100%
12.50	80%	13.4	99%
12.30	70%	13.3	95%
12.15	60%	13.2	90%
12.05	50%	13.1	40%
11.95	40%	13.0	30%
11.80	30%	12.9	20%
11.65	20%	12.8	17%
11.50	10%	12.5	15%
10.50	0%	10.50	0%

Por lo tanto, si ya ha instalado un monitor de batería diseñado para baterías de plomo-ácido, tendrá una lectura del estado de carga de la batería de litio completamente incorrecta. Los Monitores de Baterías que se proponen a continuación incluyen un SHUNT que mide la corriente de entrada y salida. De esta forma son capaces de dar una estimación correcta del estado de carga real de la batería LiFePO₄.

BATTERY MONITOR



VICTRON ENERGY



El VICTRON BMV-712 SMART es el monitor de batería más famoso del mercado.
Excelente APLICACIÓN PARA SMARTPHONE EN IDIOMA ITALIANO.

CÓDIGO DE TIENDA DE LITIO: #LS-BM-
VBMV
CÓDIGO DEL FABRICANTE:
#BAM030712000

**Monitor de Batería BMV-712
Inteligente**

206,18€

El VICTRON SMARTSHUNT tiene las mismas características que el BMV-712, pero no tiene un monitor externo. El monitoreo de la batería se realiza únicamente a través de BLUETOOTH.



CÓDIGO DE TIENDA DE LITIO: #LS-BM-
VSSH
CÓDIGO DEL FABRICANTE:
#SHU050150050

**Derivación inteligente
500A/50mV
145,18 €**

BATTERY MONITOR



VICTRON ENERGY



CÓDIGO LITIO STORE: #LS-BM-VCER

CÓDIGO VICTRON: #BPP900450100

CerboGX

358,68€

Victron CERBO GX es la unidad de control del sistema Victron Energy, a la que se pueden conectar los accesorios de Victron.

Los valores se mostrarán en la pantalla GX TOUCH 5"/7".

Sondas de tanque y temperatura. Conexión al portal VRM, posibilidad de monitorear el sistema de forma remota.

Display Victron Energy GX TOUCH, para conectar a la centralita CERBO GX. Disponible en 5" y 7".



CÓDIGO LITIO STORE: #LS-BM-VGX5

CÓDIGO VICTRON: #BPP900455050

GX táctil 50/70

422,12 €

BATTERY MONITOR



BATTERY MONITOR SIMARINE

100%
MADE IN
SLOVENIA



BATTERY MONITOR



LOS UNICOS
BATTERY MONITOR
100% MADE IN E.U.



SIMARINE



Empresa
ESLOVENA

BATTERY MONITOR



Distribuidores oficiales de SIMARINE MONITOR DE BATERÍA (Hecho en Eslovenia)

Los monitores de baterías Simarine tienen una particularidad: permiten visualizar en la pantalla el consumo de cada dispositivo individual conectado al sistema. esto esta renderizado posible gracias a derivaciones particulares que leen el consumo de múltiples usuarios. Por tanto podrás ver el consumo de la nevera, luces, bombas de agua, etc etc...



BATTERY MONITOR



Distribuidores oficiales de SIMARINE MONITOR DE BATERÍA (Hecho en Eslovenia)

PANEL DE MANDOS Pantalla táctil con carcasa de aluminio de muy alta calidad, diseñada para embarcaciones.

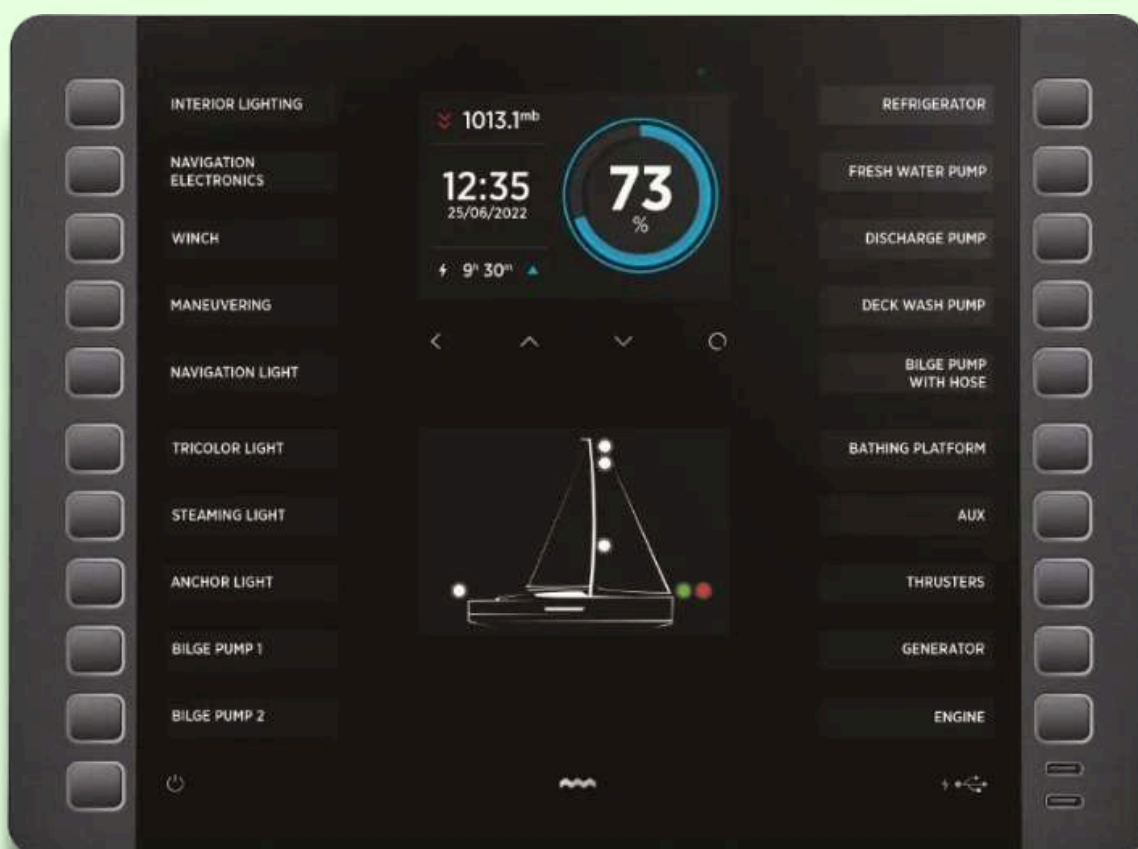

BATTERY MONITOR



Distribuidores oficiales de SIMARINE MONITOR DE BATERÍA (Hecho en Eslovenia)



TEMPERATURA



Nuestra CONSULTORÍA para
instalación y configuración



Nivel del tanque



BARÓMETRO



BATTERY MONITOR SIMARINE



PRODUCT CODE: #LS-BM-SPICO

PICO MONITOR

Monitor de batería en Alluminio,
WiFi + aplicaciones Android e iOS, Barógrafo

€ 292,00



INPUTS:
1X CURRENT 300A
2X VOLTAGE 0-75V
3X RESISTIVE 0-65KOHM
(TANKS OR TEMPERATURES)

PRODUCT CODE: #LS-BM-SSC303

SC303 DIGITAL SHUNT 300A

€ 116,00



INPUTS:
1X CURRENT 500A
2X VOLTAGE 0-75V
3X RESISTIVE 0-65KOHM
(TANKS OR TEMPERATURES)

PRODUCT CODE: #LS-BM-SSC503

SC503 DIGITAL SHUNT 500A

€ 139,00



INPUTS:
4X CURRENT 25A
1X RELAY OUTPUT 1A

PRODUCT CODE: #LS-BM-SSCQ25

SCQ25

QUADRO SHUNT 4x25A

€ 139,00



INPUTS:
4X CURRENT 25A
3X VOLTAGE
4X RESISTIVE 0-65KOHM
(TANKS OR TEMPERATURES)

PRODUCT CODE: #LS-BM-SSCQ25T

SCQ25T

QUADRO SHUNT 4x25A
+ módulo de sonda

€ 195,00



INPUTS:
4X CURRENT 50A
1X RELAY OUTPUT 1A

PRODUCT CODE: #LS-BM-SSCQ50

SCQ50

QUADRO SHUNT 4x50A

€ 193,00



INPUTS:
3X VOLTAGE 0-35V
4X RESISTIVE 0-65KOHM (TANKS
OR TEMPERATURE)
1X RELAY OUTPUT 1A

PRODUCT CODE: #LS-BM-SST107

ST107

MÓDULO SONDAS DE
TEMPERATURA Y DEPÓSITOS

€ 2499,90



PRODUCT CODE: #LS-BM-SSDI01

SDI01

INCLINÓMETRO

€ 279,90



PRODUCT CODE: #LS-BM-SNMEA

NMEA 2000 gateway

€ 1199,90

BATTERY MONITOR SIMARINE



PRODUCT CODE: #LS-BM-SPICOO

PICO ONE Set

PICO Monitor + SC303

€ 369,00



PRODUCT CODE: #LS-BM-SPICOS

PICO STANDARD Set

PICO Monitor + SC303 + ST107

€ 475,00



PRODUCT CODE: #LS-BM-SPICOB

PICO BLUE Set

PICO Monitor + SC303 + ST107 + SCQ25

€ 609,00



PRODUCT CODE: #LS-BM-SCCS

CARAVAN CONTROL Set

- Control Panel SCC8
- Power Distribution Unit SPDU-52

€ 655,00



PRODUCT CODE: #LS-BM-SNER2

NEREIDE 2

Panel de control de 18 teclas en aluminio anodizado.
PICO integrado

€ 793,00



PRODUCT CODE: #LS-BM-SNERP

NEREIDE PRO

Ampliable con múltiples PDU AC/DC y con SRB530

€ 1464,00



PRODUCT CODE: #LS-CA-4885

SAC03

AC POWER UNIT

€ 1159,00



PRODUCT CODE: #LS-CA-LS9610

SPU303

DC POWER UNIT

€ 915,00



PRODUCT CODE: #LS-CA-LS9630

SRB530

REMOTE SWITCH AND BILGE PUMP UNIT

€ 244,00

INVERTER

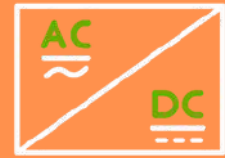

Descargue
LISTA DE PRECIOS
Victron actualizada



Inverter Phoenix



**Inversor y cargador
Multiplus/Quattro**

INVERTER

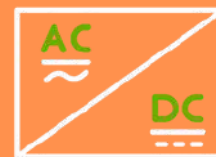

VICTRON ENERGY P H O E N I X



CODICE LITIO STORE: #LS-IN-VP12250

CODICE PRODUTTORE: #PIN121251200

Phoenix 12/250 VE.Direct

12/24V 250VA

€ 125,66



CODICE LITIO STORE: #LS-IN-VP12375

CODICE PRODUTTORE: #PIN121371200

Phoenix 12/375 VE.Direct

12/24V 375VA

€ 162,26



CODICE LITIO STORE: #LS-IN-VP12500

CODICE PRODUTTORE: #PIN121501200

Phoenix 12/500 VE.Direct

12/24V 500VA

€ 202,52



CODICE LITIO STORE: #LS-IN-VP12800

CODICE PRODUTTORE: #PIN121801200

Phoenix 12/800 VE.Direct

12/24V 800VA

€ 329,40



CODICE LITIO STORE: #LS-IN-VP121200

CODICE PRODUTTORE: #PIN12212120

Phoenix 12/1200 VE.Direct

12/24V 375VA

€ 435,54



CODICE LITIO STORE: #LS-IN-VP121600S

CODICE PRODUTTORE: #PIN122161000

Phoenix 12/1600 Smart

12/24V 1600VA **BLUETOOTH**

€ 700,28

INVERTER

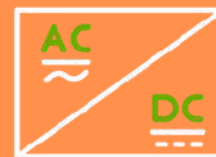

VICTRON ENERGY P H O E N I X



CODICE LITIO STORE: #LS-IN-VP122000S

CODICE PRODUTTORE: #PIN122201000

Phoenix 12/2000 Smart

12/24V 2000VA **BLUETOOTH**

€ 834,48



CODICE LITIO STORE: #LS-IN-VP123000S

CODICE PRODUTTORE: #PIN122300000

Phoenix 12/3000 Smart

12/24V 3000VA **BLUETOOTH**

€ 1123,62



CODICE LITIO STORE: #LS-IN-VP245000S

CODICE PRODUTTORE: #PIN242500000

Phoenix 24/5000 Smart

24V 3000VA **BLUETOOTH**

€ 2069,12



CODICE LITIO STORE: #LS-IN-VP482000S

CODICE PRODUTTORE: #PIN482201000

Phoenix 48/2000 Smart

48V 2000VA **BLUETOOTH**

€ 928,42



CODICE LITIO STORE: #LS-IN-VP483000S

CODICE PRODUTTORE: #PIN482300000

Phoenix 48/3000 Smart

48V 3000VA **BLUETOOTH**

€ 1185,84



CODICE LITIO STORE: #LS-IN-VP485000S

CODICE PRODUTTORE: #PIN482500000

Phoenix 48/5000 Smart

48V 5000VA **BLUETOOTH**

€ 1777,54

INVERTER

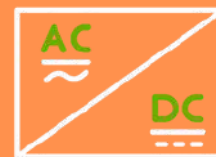

VICTRON ENERGY MULTIPLUS



CODICE LITIO STORE: #LS-IN-VM12800

CODICE PRODUTTORE: #PMP121800000

MultiPlus 12/800/35-16
inverter 800VA
Caricabatterie 35A
€ 634,40



CODICE LITIO STORE: #LS-IN-VM121200C

CODICE PRODUTTORE: #CMP121220000

MultiPlus C 12/1200/50-16
inverter 1200VA
Caricabatterie 50A
€ 913,78



CODICE LITIO STORE: #LS-IN-VM121600C

CODICE PRODUTTORE: #CMP121620000

MultiPlus C 12/1600/70-16
inverter 1600VA
Caricabatterie 70A
€ 1024,80



CODICE LITIO STORE: #LS-IN-VM122000C

CODICE PRODUTTORE: #CMP122200000

MultiPlus C 12/2000/80-30
inverter 2000VA
Caricabatterie 80A
€ 1385,92



CODICE LITIO STORE: #LS-IN-VM123000

CODICE PRODUTTORE: #PMP122300001

MultiPlus 12/3000/120-16
inverter 3000VA
Caricabatterie 120A
€ 1712,88



CODICE LITIO STORE: #LS-IN-VM123000

CODICE PRODUTTORE: #PMP122305010

MultiPlus-II 12/3000/120-32
inverter 3000VA
Caricabatterie 120A
€ 1673,84

INVERTER

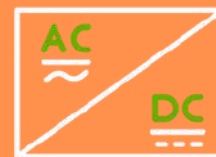

VICTRON ENERGY ACCESSORI



CODICE LITIO STORE: #LS-IA-VPICVE
CODICE PRODUTTORE: #REC040010210R

**Phoenix Inverter Control
VE.Direct**

€ 26,84



CODICE LITIO STORE: #LS-IA-VPIC
CODICE PRODUTTORE: #REC030001210

Phoenix Inverter Control

€ 113,46



CODICE LITIO STORE: #LS-IA-VDMC
CODICE PRODUTTORE: #REC020005010

**Digital Multi Control
(multiplus/quattro)**

€ 173,24



CODICE LITIO STORE: #LS-IA-VMK3
CODICE PRODUTTORE: #ASS030140000

**Interface MK3 USB
VE Bus-to-USB**

€ 89,06



CODICE LITIO STORE: #LS-IA-VSD
CODICE PRODUTTORE: #ASS030537010

VE.Bus Smart dongle

€ 122,00



**Scarica LISTINO
Victron aggiornato**

DC-DC CONVERTER



VICTRON ENERGY D C - D C



CODICE LITIO STORE: #LS-CO-0241225

CODICE PRODUTTORE: #ORI241225020

Orion 24/12-25
€ 89,06



CODICE LITIO STORE: #LS-CO-0241270

CODICE PRODUTTORE: #ORI241270030

Orion 24/12-70
€ 162,26



CODICE LITIO STORE: #LS-CO-0122415

CODICE PRODUTTORE: #ORI122441110

Orion-Tr 12/24-15A (360W)
€ 280,60



CODICE LITIO STORE: #LS-CO-0481209

CODICE PRODUTTORE: #ORI481210110

Orion 48/12-9
€ 82,96



CODICE LITIO STORE: #LS-CO-0241270

CODICE PRODUTTORE: #ORI481224110

Orion 48/12-30
€ 262,30



Scarica LISTINO
Victron aggiornato

LOS MEJORES ACCESORIOS PARA TU Sistema eléctrico de 12V-96V

12V - 96V



Cables



Fusibles



interruptor de batería



Busbar barra colectora

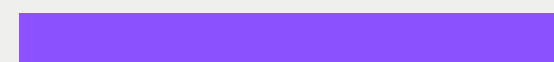

Conectores



C.A.



CABLES



PRODUCT CODE: #LS-AC-CA4S_120

- Súper flexible
- Certificado para uso náutico

SECCIÓN	PRECIO
4mm ² solare	€ 1,38
6mm ² solare	€ 2,12
10mm ² solare	€ 4,62
10mm ²	€ 3,66
16mm ²	€ 4,40
25mm ²	€ 6,64
35mm ²	€ 8,99
50mm ²	€ 12,27
70mm ²	€ 19,85
95mm ²	€ 24,25
120mm ²	€ 37,63

FUSIBLES



ITALWEBER

Empresa
ITALIANA



MTA

Empresa
ITALIANA



iMaXX

Empresa
HOLANDESE



VICTRON
ENERGY

Empresa
HOLANDESE



EATON

Empresa
EE.UU.



MP

Empresa
EE.UU.

FUSIBLES



ITALWEBER
Un mondo di protezione



Empresa
ITALIANA



PRODUCT CODE: #LS-FU-F-CIL500IT

Fusible cerámico cilíndrico

MAX 500V
1A / 4 / 10 / 16 / 20 / 25 / 32A

€ 5,90



PRODUCT CODE: #LS-FU-P-CIL500IT

Portafusibles

€ 8,90

FUSIBLES



Empresa
ITALIANA



PRODUCT CODE: #LS-FU-F-CIL500IT

Fusible MIDI 24V

€ 5,00



PRODUCT CODE: #LS-FU-P-CIL500IT

Portafusibles

€ 9,00



PRODUCT CODE: #LS-FU-P-CIL500IT

Portafusibles x3

€ 25,00

FUSIBLES



Empresa
HOLANDESE



PRODUCT CODE: #LS-FU-F-MN48IM

Fusible MINI 48V

2A / 3 / 4 / 5 / 7,5 / 10 / 15 / 20 / 25 30A

€ 0,50



PRODUCT CODE: #LS-FU-F-MD48IM

Fusible MIDI 48V

30A / 40 / 50 / 60 / 70 / 80 / 100 / 125 / 150 / 175 / 200A

€ 3,90



PRODUCT CODE: #LS-FU-F-CU48IM

Fusible CUBIC 48V

30A / 50 / 75 / 100 / 125 / 150 / 200 / 250 / 300A

€ 7,90

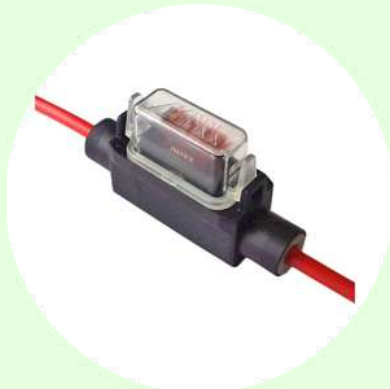

PRODUCT CODE: #LS-FU-P-MN48IM

Portafusibles MINI 48V Blade fuse

€ 3,20



PRODUCT CODE: #LS-FU-P-MD48IM

Portafusibles MIDI 48V

€ 7,90



PRODUCT CODE: #LS-FU-P-CU48IM

Portafusibles CUBIC 48V

€ 12,90

FUSIBLES



Azienda
OLANDESE



CODICE LITIO STORE: #LS-FU-F-MEGA48VI

CODICE PRODUTTORE: #CIP136060010

MEGA 24V MEGA 48V

€ 7,00

€ 37,82



CODICE LITIO STORE: #LS-FU-P-MIDI24VI

CODICE PRODUTTORE: #CIP132060010

MIDI 24V MIDI 48V

€ 6,00

€ 13,42



CODICE LITIO STORE: #LS-FU-P-MEGA48VI6

CODICE PRODUTTORE: #CIP050060000

**Portafusibles MEGA
6P 250A**

€ 36,60



CODICE LITIO STORE: #LS-FU-P-MEGAVI

CODICE PRODUTTORE: #CIP000100001

Portafusible MEGA

€ 14,64



CODICE LITIO STORE: #LS-FU-F-MIDIVI

CODICE PRODUTTORE: #CIP000050001

Portafusibles MIDI

€ 12,20



Descarga **LISTA DE
PRECIOS**
Victron actualizada

FUSIBLES 96V



Empresa
EE.UU.



CODICE LITIO STORE: #LS-FU-F-MEGA96125EA

CODICE PRODUTTORE: #AMX-80_350

Fusible MEGA 96V

80A / 100 / 150 / 200 / 250 / 300 / 350A

€ 19,90



CODICE LITIO STORE: #LS-FU-P-MEGA961000EA

CODICE PRODUTTORE: #BSCR101

Portafusible 1000V

NE SONO NECESSARI DUE PER FUSIBILE

€ 24,90

FUSIBLES



Azienda
AMERICANA

36V



CODICE LITIO STORE: #LS-FU-F-MP24PR

CODICE PRODUTTORE: #MP-SERIES-53

MP Fusible automático rearmable

10A / 15 / 20 / 30 / 40 / 50 / 60A

€ 49,90

**WATERPROOF
IP67**

48V



CODICE LITIO STORE: #LS-FU-F-MP48CB

CODICE PRODUTTORE: #MP-SERIES-87

MP Serie 87 Fusible automático rearmable

25A / 30 / 40 / 50 / 60 / 70 / 80 / 100 / 120 /
150 / 175 / 200 / 225 / 250A

€ 99,90

**WATERPROOF
IP66**

INTERRUPTOR DE BATERÍA



CODICE LITIO STORE: #LS-ST-V47

CODICE PRODUTTORE: #VBS127010010

Staccabatterie 48V 275A

€ 45,14



CODICE LITIO STORE: #LS-ST-V65S

CODICE PRODUTTORE: #BPR065022000

Smart BatteryProtect 65A

24V

€ 74,42

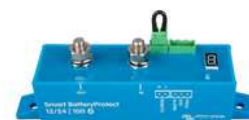

CODICE LITIO STORE: #LS-ST-V100S

CODICE PRODUTTORE: #BPR110022000

Smart BatteryProtect 100A

24V

€ 97,60



CODICE LITIO STORE: #LS-ST-V220S

CODICE PRODUTTORE: #BPR122022000

Smart BatteryProtect 220A

24V

€ 145,18



CODICE LITIO STORE: #LS-ST-V48100S

CODICE PRODUTTORE: #BPR110048000

Smart BatteryProtect 48V 100A

48V

€ 189,10

Scarica **LISTINO**
Victron aggiornato



BUSBAR



CODICE LITIO STORE: #LS-BB-V2P150

CODICE PRODUTTORE: #VBB115021020

Busbar 2P 150A

€ 28,06



CODICE LITIO STORE: #LS-BB-V4P150

CODICE PRODUTTORE: #VBB115040020

Busbar 4P 150A + cover

€ 24,40



CODICE LITIO STORE: #LS-BB-V4P250

CODICE PRODUTTORE: #VBB125040010

Busbar 4P 250A + cover

€ 74,42



CODICE LITIO STORE: #LS-BB-V6P250

CODICE PRODUTTORE: #VBB125060020

Busbar 6P 250A + cover

€ 80,52



CODICE LITIO STORE: #LS-BB-VP8

CODICE PRODUTTORE: #LYN020102000

Lynx Power in

€ 183,00



CODICE LITIO STORE: #LS-BB-VD8

CODICE PRODUTTORE: #LYN060102000

Lynx Distributor

€ 262,30



PRODUCT CODE: #LS-BB-SE6P48250

Busbar 4P 250A + cover

€ 34,90



Scarica **LISTINO**
Victron aggiornato

CONECTORES



PRODUCT CODE: #LS-CON-CT

Capocorda tubolari

SECCIÓN	PREZZO
2,5 M6	0,20 €
4 M6	0,22 €
6 M6	0,23 €
6 M8	0,23 €
10 M6	0,27 €
10 M8	0,27 €
10 M10	0,48 €
16 M6	0,38 €
16 M8	0,38 €
16 M10	0,38 €
25 M6	0,87 €
25 M8	0,45 €
25 M10	0,45 €
35 M8	0,68 €
35 M10	0,68 €
35 M12	0,68 €

SECCIÓN	PREZZO
50 M8	1,13 €
50 M10	1,13 €
50 M12	1,13 €
70 M8	1,92 €
70 M10	1,53 €
70 M12	1,53 €
95 M8	3,68 €
95 M10	2,77 €
95 M12	2,77 €
120 M10	3,62 €
120 M12	3,62 €
120 M12	3,62 €
150 M12	4,72 €
185 M12	7,69 €
185 M16	7,69 €
240 M16	9,34 €

CONECTORES



PRODUCT CODE: #LS-CON-TB

Terminali de casquillo

SECCIÓN	PREZZO Conf. 100pz	PREZZO Conf. 20pz	PREZZO Singolo
1X1,5	1,18 €	0,59 €	0,06 €
1X2,5	1,63 €	0,81 €	0,08 €
1X4	2,43 €	1,21 €	0,12 €
1X6	5,25 €	2,63 €	0,26 €
1X10	5,95 €	2,98 €	0,30 €
1X16	6,65 €	3,33 €	0,33 €
1X25	10,88 €	5,44 €	0,54 €
1X35	16,83 €	8,41 €	0,84 €
2X1,5	2,58 €	1,29 €	0,13 €
2X2,5	3,90 €	1,95 €	0,20 €
2X4	4,85 €	2,43 €	0,24 €
2X6	7,45 €	3,73 €	0,37 €
2X10	12,18 €	6,09 €	0,61 €
2X16	16,65 €	8,33 €	0,83 €

CONECTORES



PRODUCT CODE: #LS-CON-MC4X2

M-F conectores MC4

€ 1,70



PRODUCT CODE: #LS-CON-MC42X

Divisor de 2 MC4

€ 7,60



PRODUCT CODE: #LS-CON-MC43X

Divisor de 3 MC4

€ 18,32

C.A.

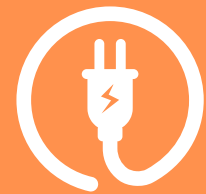

CODICE LITIO STORE: #LS-AL-VPI16P

CODICE PRODUTTORE: #SHP301603000

16A Power Inlet (polyamid)

€ 85,40



CODICE LITIO STORE: #LS-AL-VPI16S

CODICE PRODUTTORE: #SHP301602000

Power Inlet (acciaio)

16A	25A
€ 123,22	€ 159,82



CODICE LITIO STORE: #LS-AL-VPI16P

CODICE PRODUTTORE: #SHP302501500

Cable de extensión

15m 16A	15m 25A
€ 97,60	€ 97,60
25m 16A	25m 25A
€ 97,60	€ 97,60



CODICE LITIO STORE: #LS-AL-VAC32TM

CODICE PRODUTTORE: #SHP307700300

Adaptador monofásico a trifásico

€ 59,78



CODICE LITIO STORE: #LS-AL-VAC16C2C

CODICE PRODUTTORE: #SHP307700240

Divisor

€ 98,92

Descarga **LISTA DE
PRECIOS**
Victron actualizada



BATERÍAS PARA MOTORES ELECTRICOS



Ligereza,
durabilidad,
silencio,
aceleración infinita,
cero mantenimiento y
11 AÑOS DE GARANTÍA

CÓMO CAMBIAR DE PLOMO A LITIO

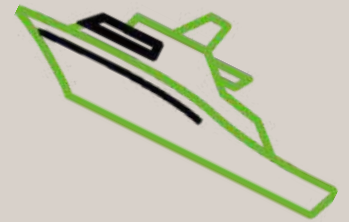

No te preocupes... Puedes reemplazar directamente la batería de plomo-ácido.

En el caso de utilizar la batería con motores eléctricos, como motores fueraborda eléctricos para embarcaciones, sólo necesitará un cargador de baterías específico para baterías LiFePO₄.

Recomiendo que duren mucho tiempo.

A las baterías de litio NO les gusta estar siempre completamente cargadas, no es necesario mantenerlas completamente cargadas como las baterías de plomo.

Si no usa baterías de litio la mayoría de los días, la única consejos que podemos dar para que duren mucho tiempo, eso es todo Precisamente para no tenerlos siempre cargados entre un uso y otro, no hace falta.

La autodescarga es inferior al 2-3% por mes... ¡Una batería al 70% puede permanecer estacionaria durante más de 2 años sin absorción de corriente!

Desconecta manualmente los cables de la batería del motor eléctrico, o mejor utiliza un seccionador de batería.

Recárgala como máximo el día anterior (o unos días antes) del siguiente uso.

De esta forma, al no mantenerla siempre al máximo de carga entre un uso y otro, no se acortará la vida útil de las baterías de litio.

Baterías para MOTORES ELÉCTRICOS



Recargue la batería de litio mediante el motor diésel/gasolina.

En el caso de barcos pesqueros con motores de combustión interna y eléctricos, las baterías de litio se pueden recargar a través del alternador, utilizando un CARGADOR DC-DC diseñado para baterías LiFePO₄.



Diagrama del sistema con MOTOR ELÉCTRICO 12V



Lista de componentes y precio

(ejemplo motor 12V 55 lbs)

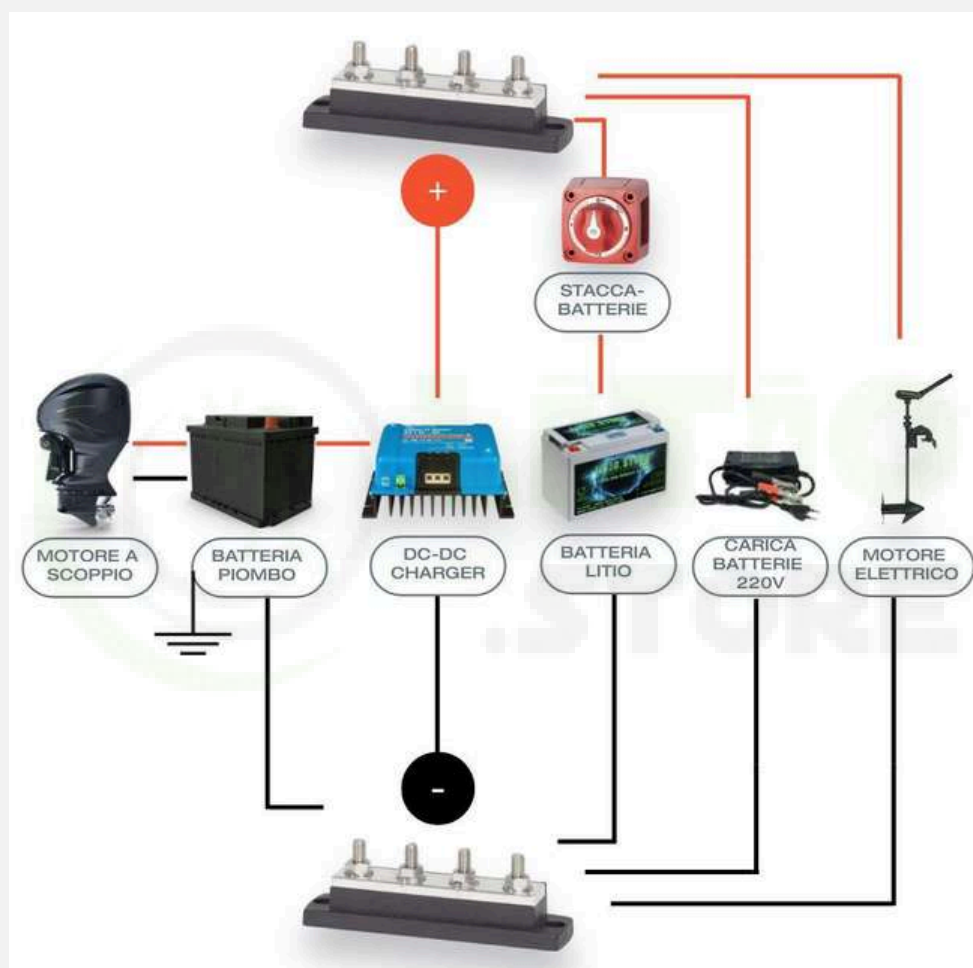
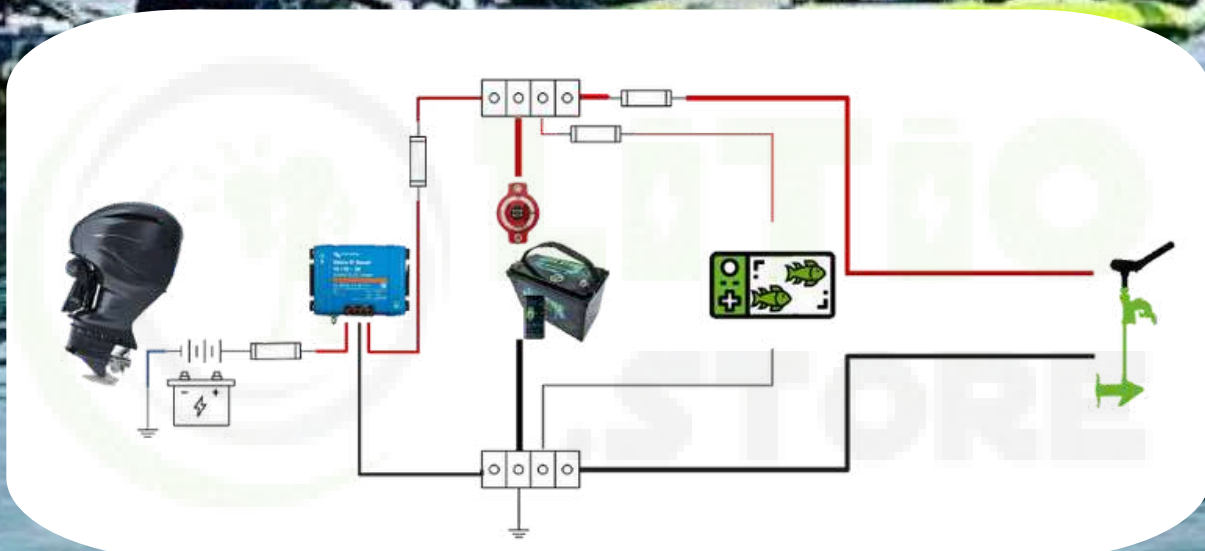
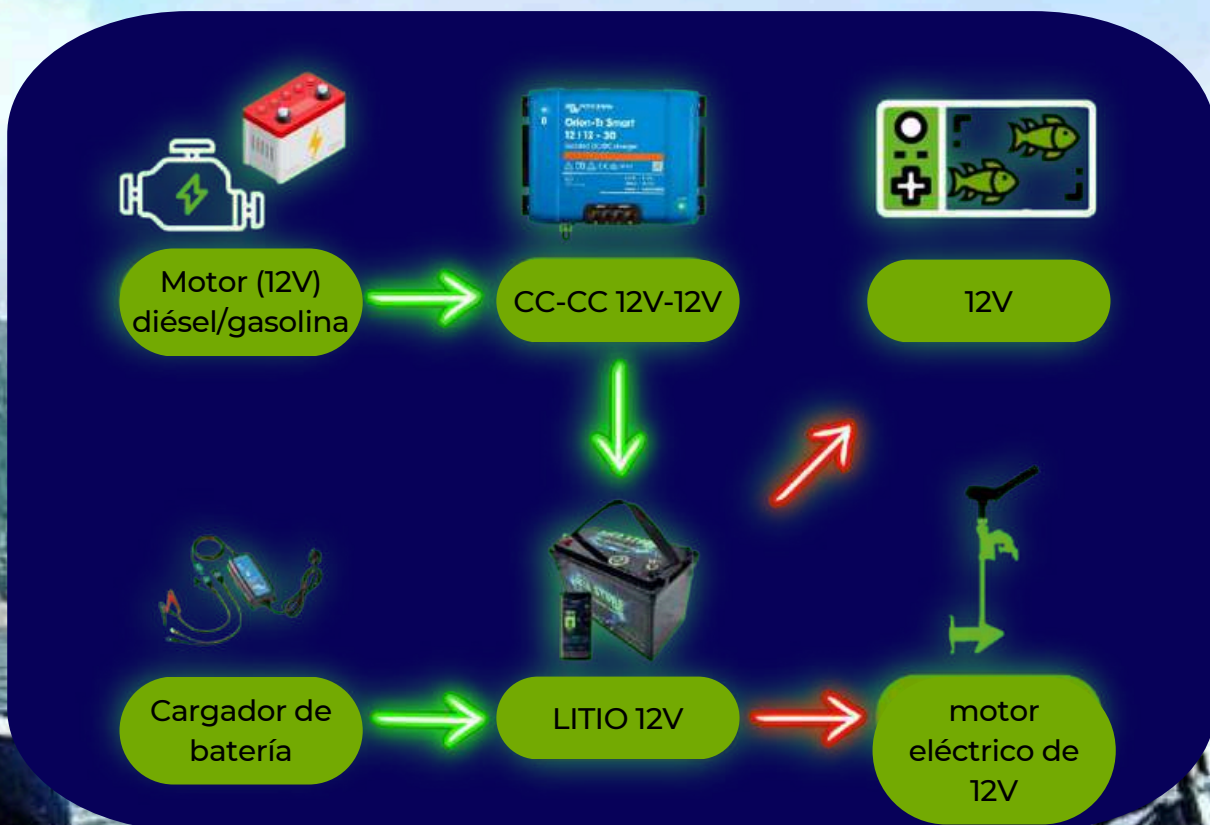
Totale
€ 1301,74

LITIO STORE



PRODUCT CODE: #LS12100B

12V 100Ah 1280Wh

€ 699,90

VICTRON ENERGY



CODICE LITIO STORE: #LS-DC-V121230N

**Orion-Tr Smart
12/12-30A Non-Isolated**

€ 208,62

MONDINI - SACIT -
BV RUBBER -
BALDASSARRI CAVI



CODICE LITIO STORE: #LS-CA35R_N

Cavo da 25mm2

€ 6,64

MTA



PRODUCT CODE: #LS-FU-F-MIDI24MT

Fusibili MIDI 40A

€ 5,00

MTA



PRODUCT CODE: #LS-FU-P-MIDI24MT

Portafusibili MIDI

€ 9,00

MP



PRODUCT CODE: #LS-FU-F-MP24PR

**SMP Fusible automático
rearmable IP67 - 60A**

€ 49,90

VICTRON ENERGY



PRODUCT CODE: #LS-BB-V4P150

Busbar 4P 150A

€ 24,40

JM



PRODUCT CODE: #LS-CON-CT25M8

**Terminales tubulares
25 M8**

€ 0,48



CODICE LITIO STORE: #LS-CA-VIP651207

Blue Smart IP65 12/7

€ 145,18

Diagrama del sistema con MOTOR ELECTRICO 24V

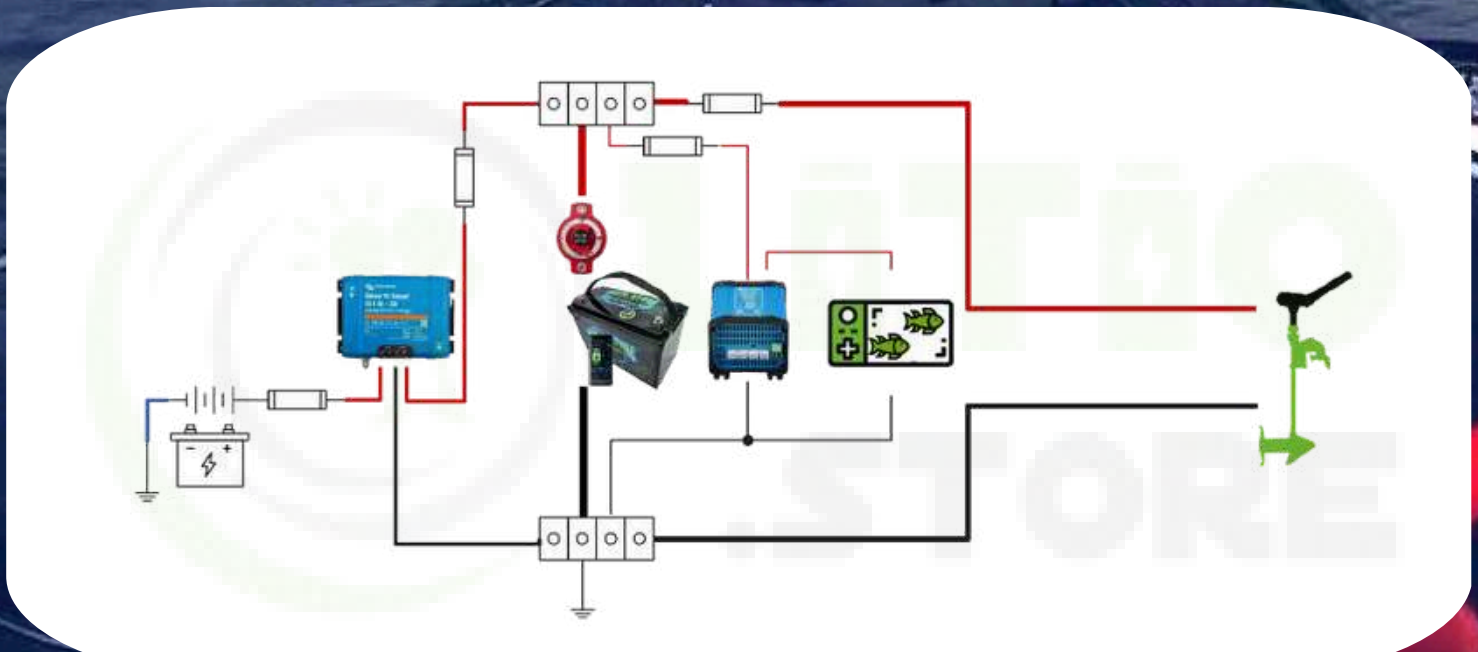
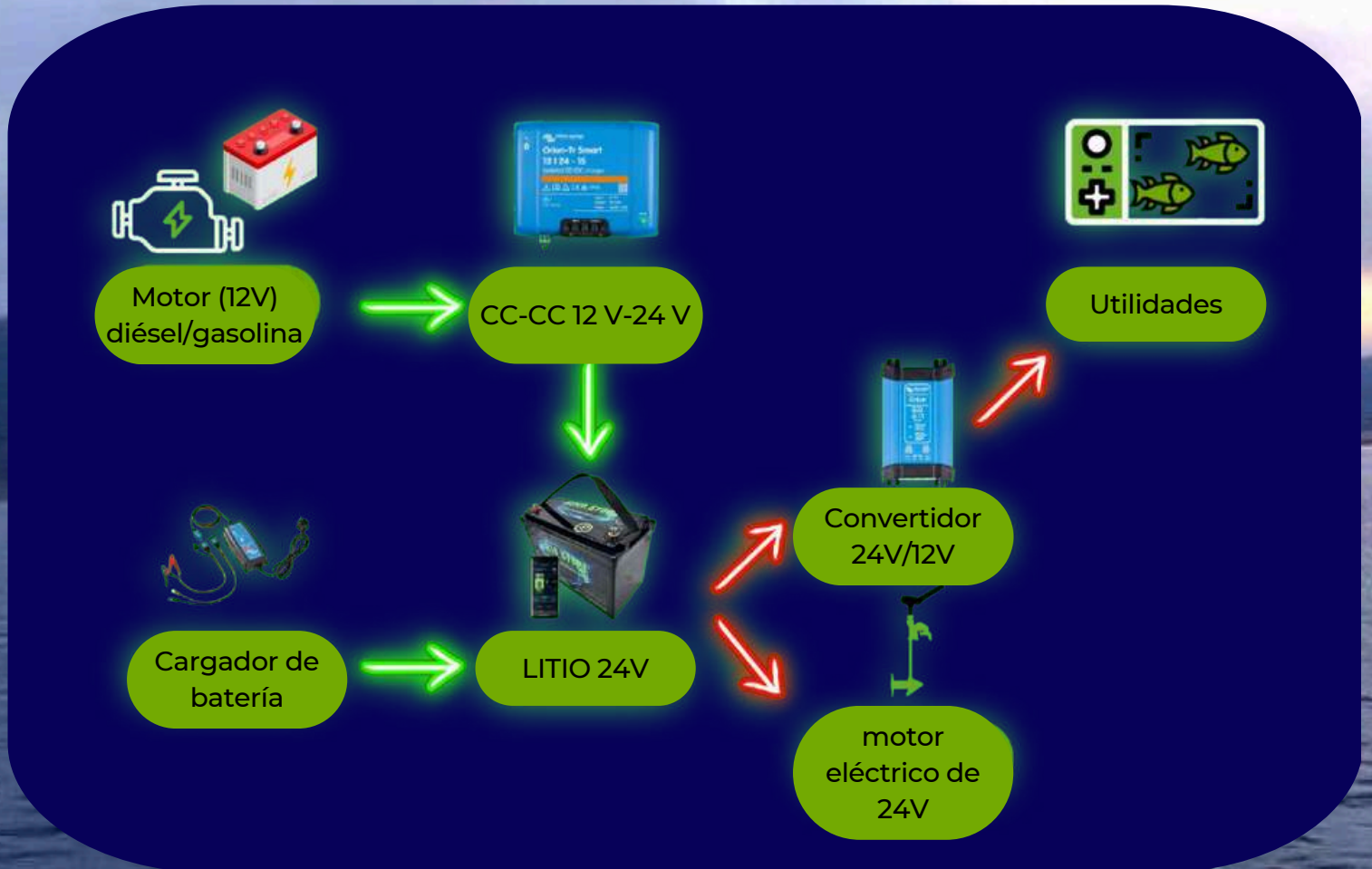

Esquema (1) sistema con MOTOR ELÉCTRICO 36V

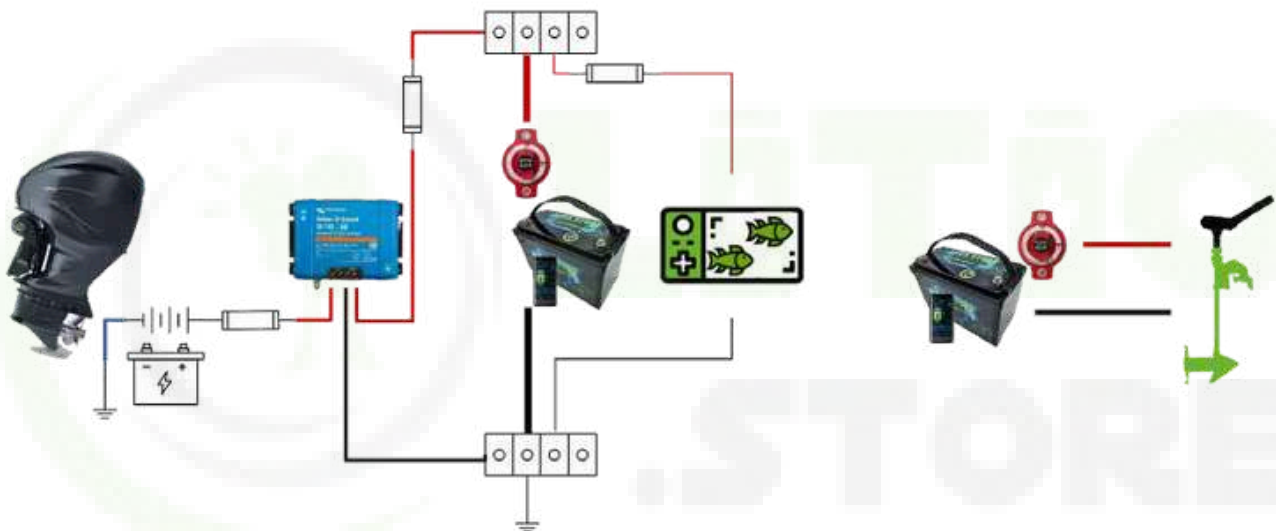

Esquema (2) sistema con MOTOR ELÉCTRICO 36V

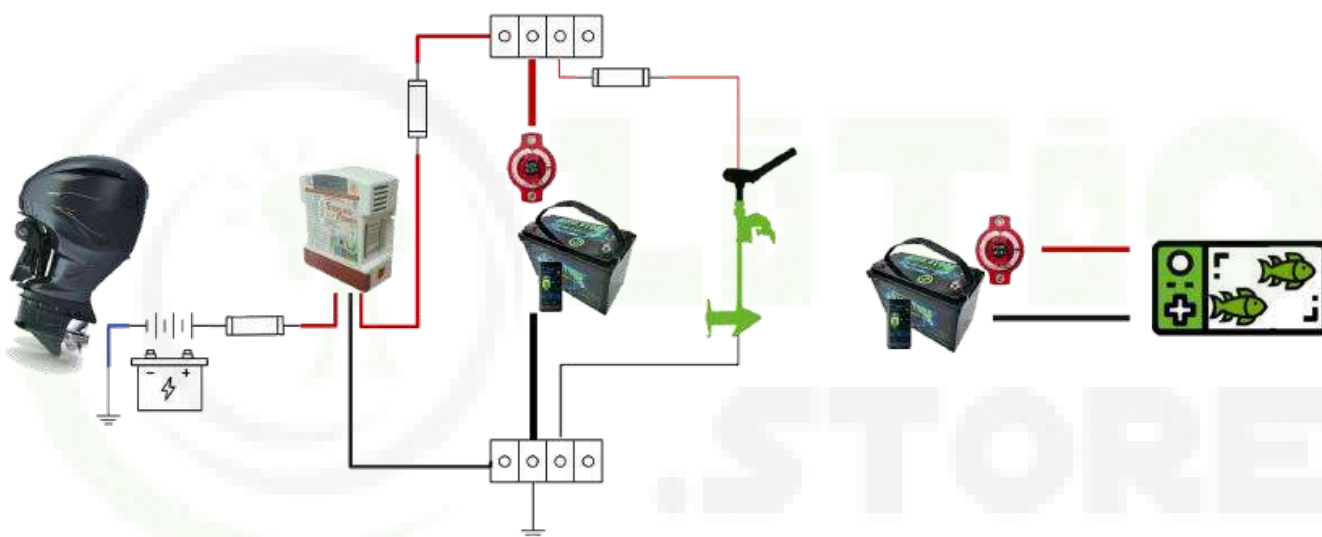

Esquema (3) sistema con MOTOR ELÉCTRICO 36V

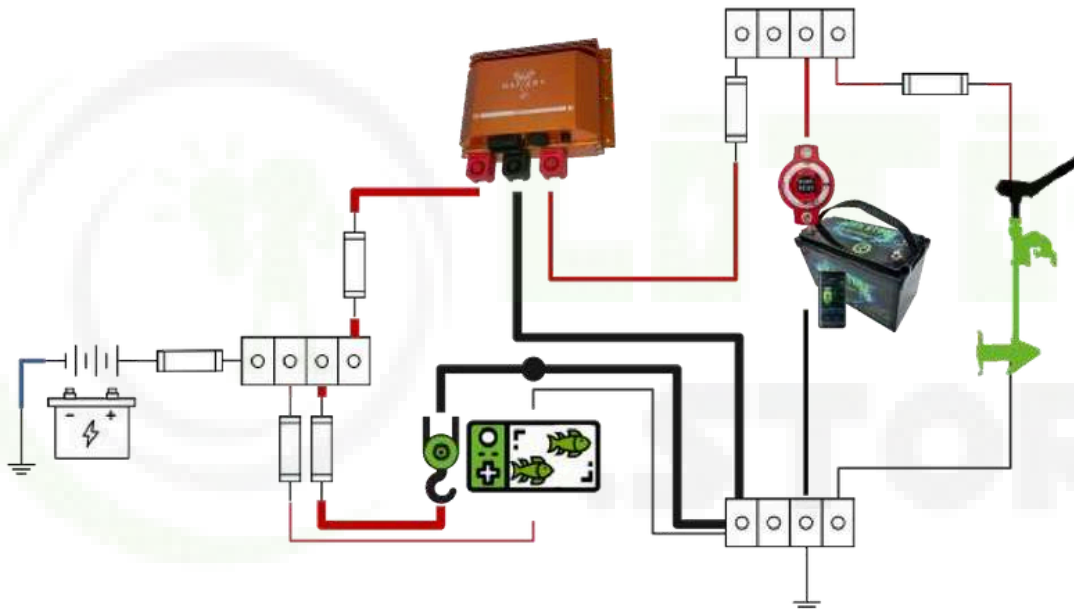

KIT BARCO ELÉCTRICO 48V



Cargador de batería
48V 3000W



LITIO
48V 200Ah



Convertidor CC-CC
48V/12V



Motor de 48V



Bombas de
achique



batería de 12v

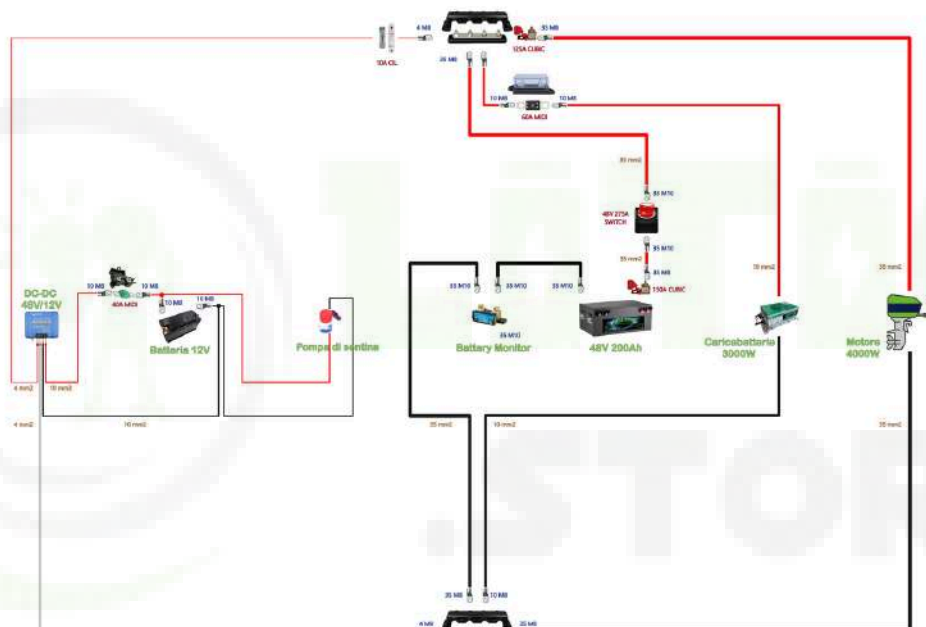

KIT BARCO ELÉCTRICO 48V

PRODUCTO	CANTIDAD	PRECIO UNO.	TOTAL
LITIO.STORE Batería LiFePO4 48V 200Ah 10.24kWh	1	6.499,90€	6.499,90€
LITIO.STORE Cargador de baterías 48V 55A 3000W	1	1.199,90€	1.199,90€
VICTRON ENERGY Smartshunt 500A	1	206,18€	206,18€
Convertidor CC-CC VICTRON ENERGY 48/12-30	1	113,46€	113,46€
Switch ON/OFF VICTRON ENERGY 48V 275A	1	45,14 €	45,14 €
Fusible CÚBICO 150A 58Vdc	1	7,90€	7,90€
Fusible CUBIC 125A 58Vdc	1	7,90€	7,90€
Portafusibles CUBIC 58Vdc	2	12,90€	25,80€
Fusible MIDI 60A 58Vcc	1	3,90€	3,90€
Portafusibles MIDI 58Vdc	1	14,90€	14,90€
Fusible MINI 10A 58Vdc	1	0,50 €	0,50 €
Fusible MIDI 40A 32Vcc	1	5,00 €	5,00 €
Portafusibles MIDI 32Vdc	1	9,00€	9,00€
Terminal tubolar 10 M8	9	0,27€	2,43€
Terminal tubolar 35 M8	5	0,68€	3,40€
Terminal tubolar 35 M10	5	0,68€	3,40€
Terminal tubolar 4 M8	2	0,15€	0,30€
Terminal de casquillo 1x4mm2	2	0,12€	0,24€
Terminal de casquillo 1x10mm2	2	0,30€	0,60€
Cable rojo 4mm2	2	1,38€	44,95€
Cable negro 4mm2	2	1,38€	44,95€
Cable Rojo 10mm2	2	3,66€	2,76€
Cable negro 10mm2	2	3,66€	2,76€
Cable Rojo 35mm2	5	8,99€	7,32€
Cable negro 35mm2	5	8,99€	7,32€
		TOTAL	8.259,91 €

SISTEMAS ELÉCTRICOS COMPLETOS SERVICIOS A BORDO DEL BARCO

Batería



Accesorios



- **Rendimiento: utiliza los electrodomésticos como si estuvieras en casa**
- **Seguridad y fiabilidad: las mismas baterías que instalamos en nuestros hogares.**
- **carga segura y súper rápida**
- **durabilidad: más de 10 años**
- **ahorrando dinero**

SISTEMAS ELÉCTRICOS COMPLETOS SERVICIOS A BORDO DE CAMPER

Batería

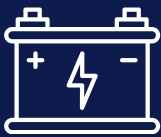

Accesorios



- **Rendimiento: utiliza los electrodomésticos como si estuvieras en casa**
- **Seguridad y fiabilidad: las mismas baterías que instalamos en nuestros hogares.**
- **carga segura y súper rápida**
- **durabilidad: más de 10 años**
- **ahorrando dinero**



TODO FUNCIONA BIEN

Funcionarán correctamente:

- secador de pelo
- placa de inducción
- refrigerador
- acondicionador

todo... todo funciona bien!



ERES TÚ QUIEN HA HECHO LA **ELECCIÓN** **CORRECTA**



¿Qué es imprescindible instalar?
Cargador CC-CC
y regulador de carga
Ver más información en la página. 36

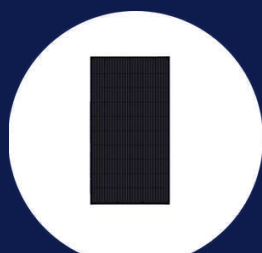

PANELES SOLARES

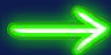

MPPT

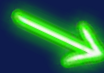

Batería de Litio



batería del motor



CC-CC

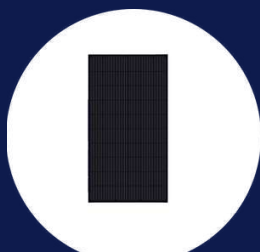

PANELES SOLARES

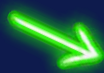

MPPT y CC-CC



Batería de Litio



batería del motor

¿CUÁNTO CUESTA
cambiarse al litio?

Batería

+

Cargador DC-DC

+

(si es necesario)

Controlador de
carga solar

Sistema COMPLETO Victron Energy 12V

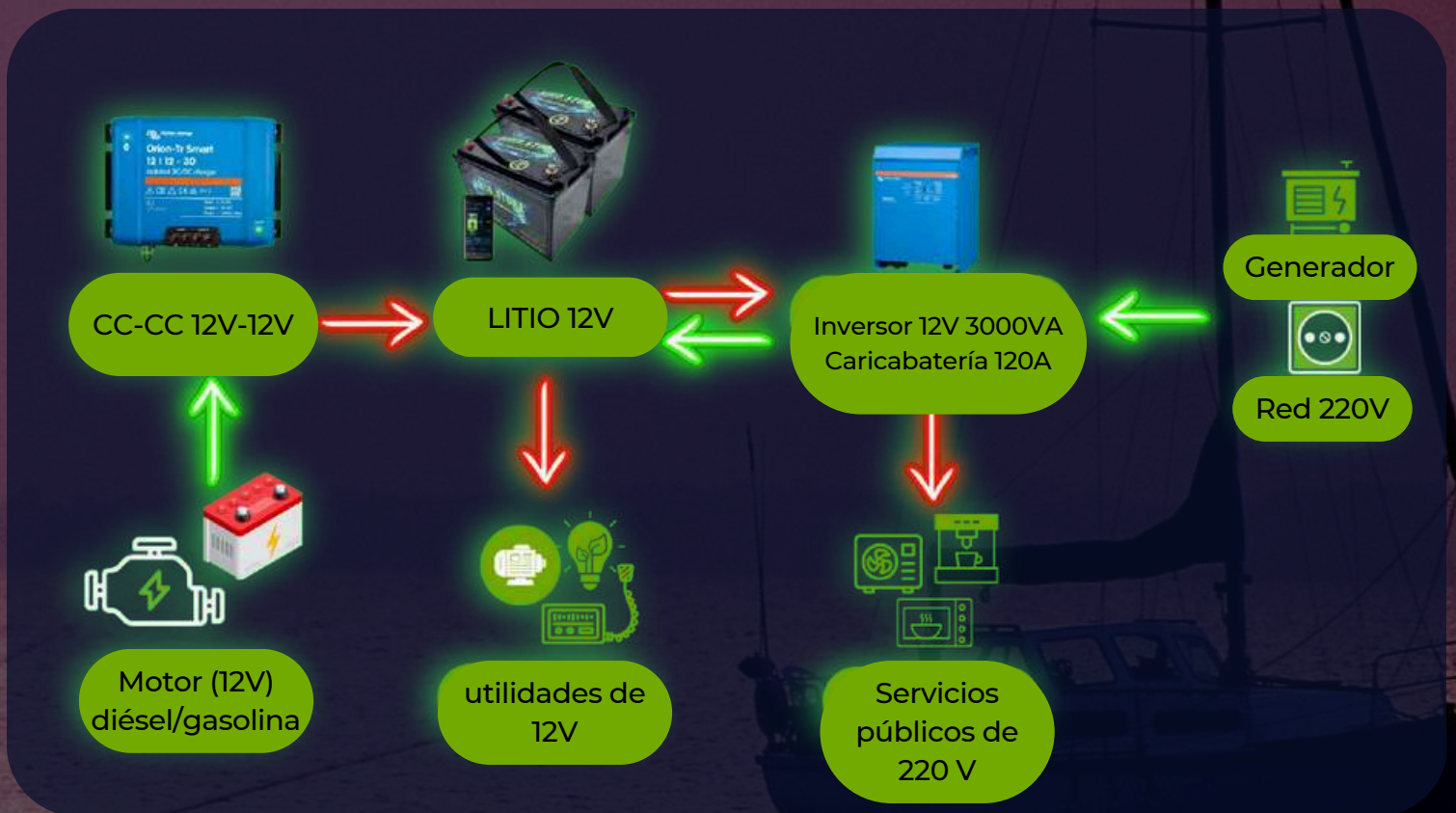

CARGADOR DC-DC



Victron Energy Orion-Tr Inteligente 18A-50A



Energía esterlina 30A-70A



Redarc CC-CC y MPPT 25-50A

INVERSOR



Inversor y batería Victron Energy MULTIPLUS



Inversor Victron Energy PHOENIX



Victron Energy Caricabatería Impermeable IP 65/67

MPPT



Victron Energy SMARTSOLAR

BATERÍA



LITIO 12V 2-12kWh

MONITOR

Victron Energy



Simarine



Sistema COMPLETO Victron Energy 12V

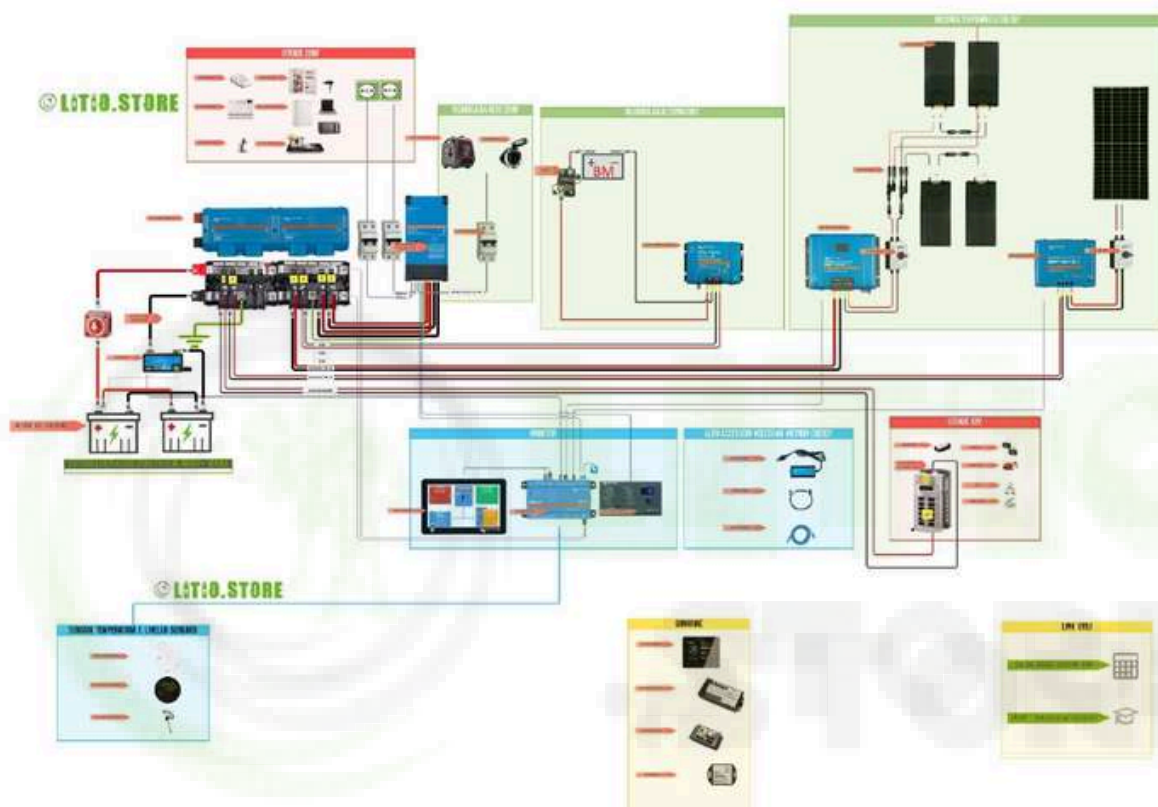
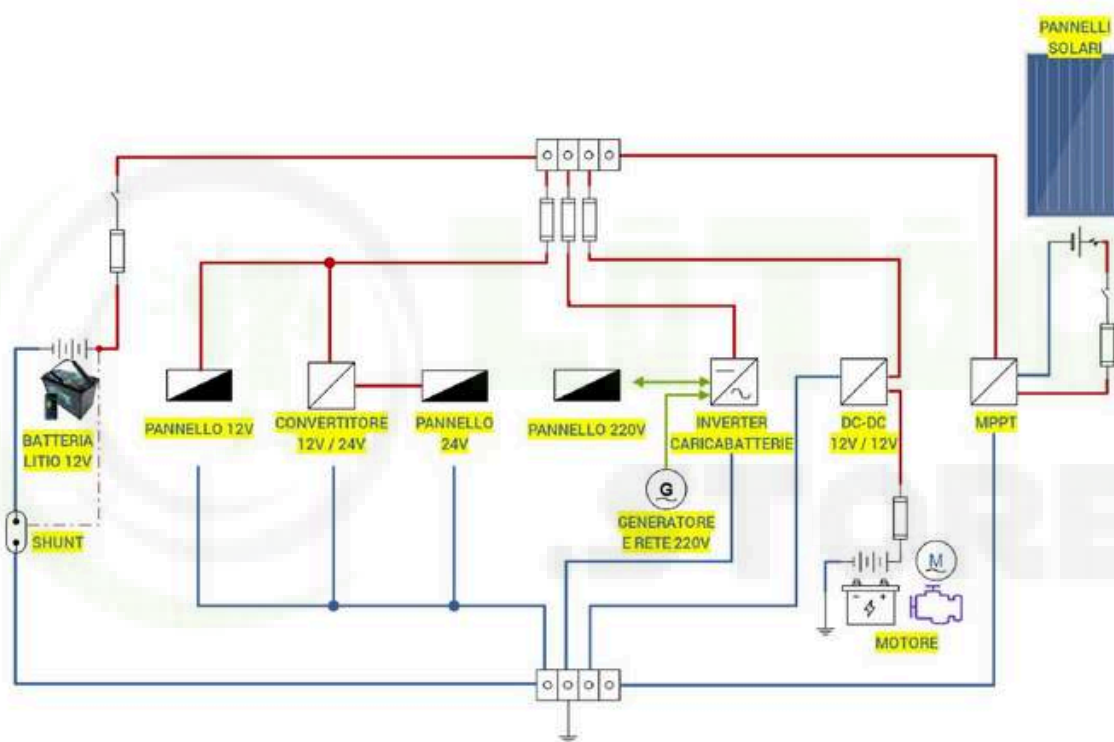

Sistema COMPLETO Victron Energy 24V (I)



CARGADOR DC-DC



Victron Energy Orion-Tr Inteligente 24V 17A



Redarc CC-CC y MPPT 24V 20 A

INVERSOR



Inversor y batería Victron Energy MULTIPLUS



Inversor Victron Energy PHOENIX



Victron Energy Caricabatería Impermeable IP 65/67

MPPT



Victron Energy SMARTSOLAR

BATERÍA



LITIO 24V 2-20kWh

MONITOR



Victron Energy

Simarine



Sistema COMPLETO Victron Energy 24V (2)

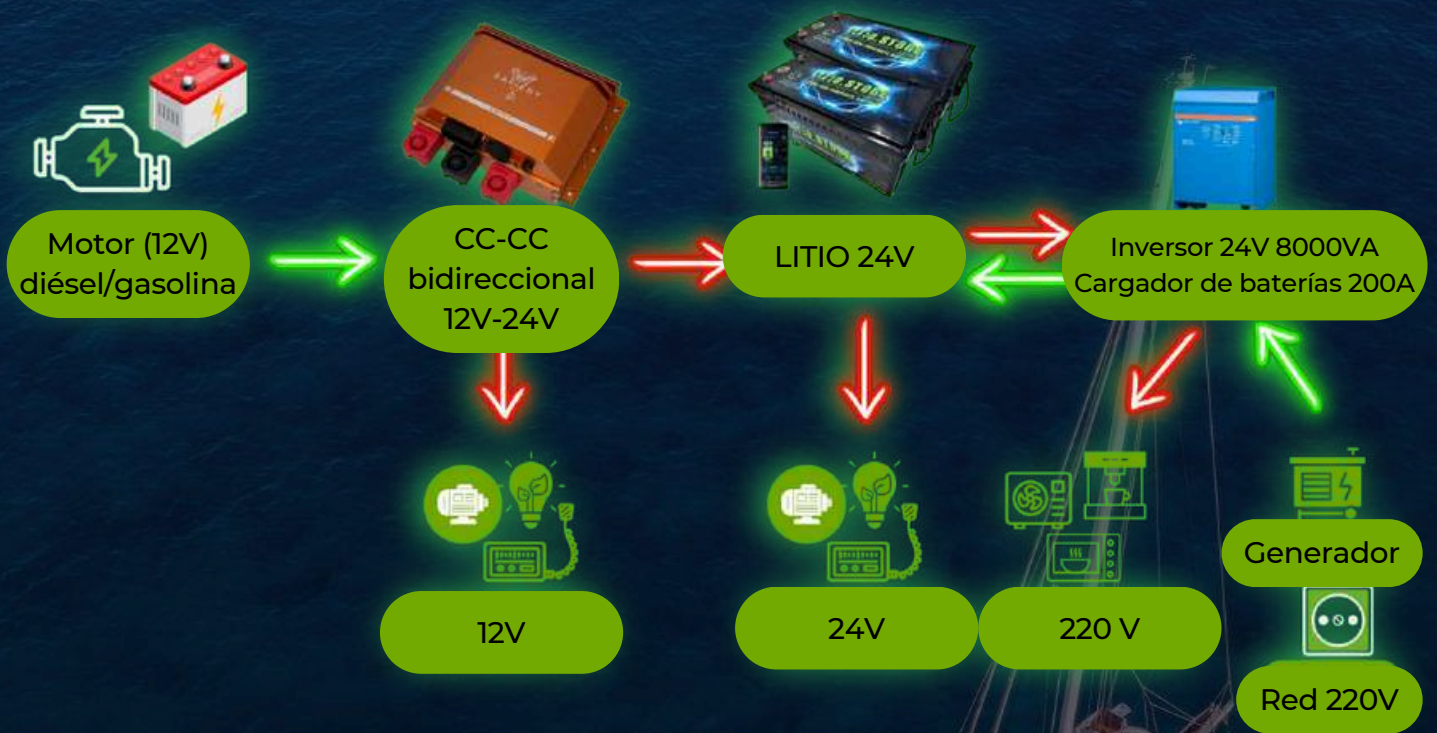

CARGADOR DC-DC



Safier Scotty
DC-DC
bidireccional
24V 60-120A
1500W-3000W

INVERSOR



Inversor y batería
Victron Energy
MULTIPLUS



Inversor
Victron Energy
PHOENIX



Victron Energy
Caricabatería
Impermeable IP
65/67

MPPT



Victron Energy
SMARTSOLAR

BATERÍA



LITIO
24V 2-20kWh

MONITOR



Victron Energy

Simarine



Sistema COMPLETO Victron Energy 48V (1)

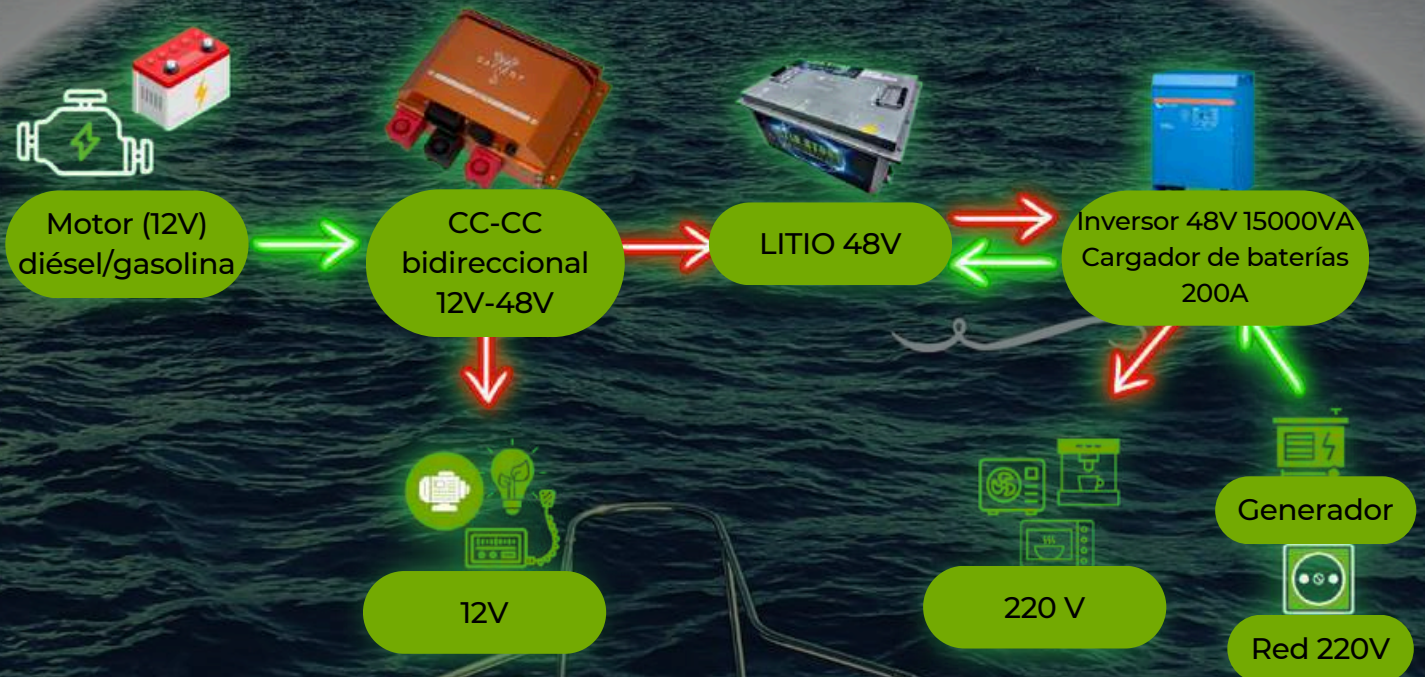

CARGADOR DC-DC



Safierly Scotty DC-DC bidireccional 48V 30-60A 1500W-3000W

INVERSOR



Inversor y batería Victron Energy MULTIPLUS



Inversor Victron Energy PHOENIX



Victron Energy Caricabatería Impermeable IP 65/67

MPPT



Victron Energy SMARTSOLAR

BATERÍA



LITIO 48V 5-20kWh

MONITOR



Victron Energy

Simarine



Sistema COMPLETO Victron Energy 48V (2)

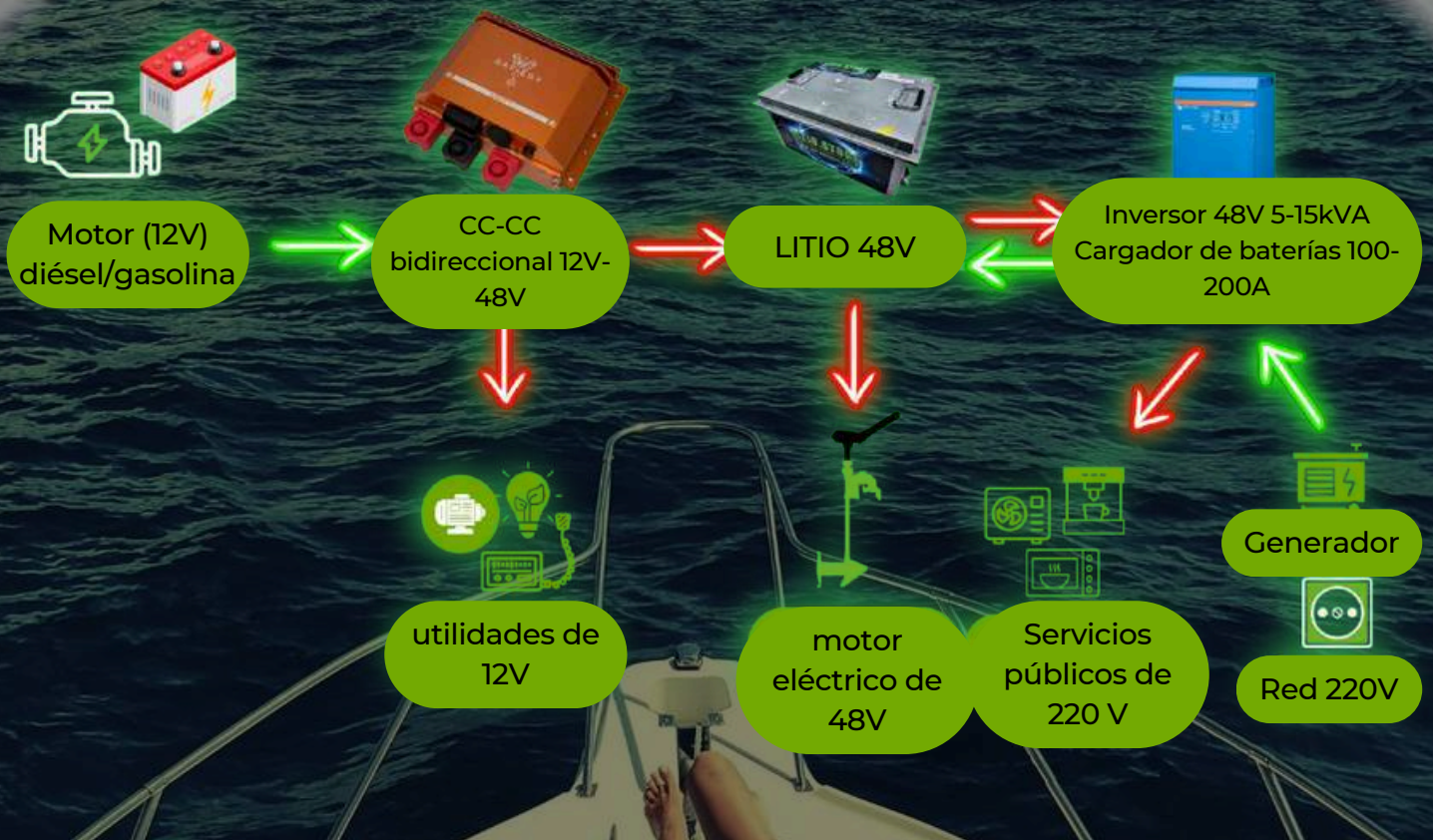

CARGADOR DC-DC



Safier Scotty
DC-DC
bidireccional
24V 60-120A
1500W-3000W

INVERSOR



Inversor y batería
Victron Energy
MULTIPLUS



Inversor
Victron Energy
PHOENIX



Victron Energy
Caricabatería
Impermeable IP
65/67

MPPT



Victron Energy
SMARTSOLAR

BATERÍA



LITIO
48V 5-60kWh

MONITOR



Victron Energy

Simarin
e



CONSEJOS GENERALES

SECCIÓN DEL CABLE

Al pasar de un sistema eléctrico con baterías de plomo a uno con baterías de litio, las corrientes que entran en juego en ocasiones serán mayores. Las corrientes más altas conducen a una revisión completa del sistema. Empezando por la elección de la sección del cable, que seguramente será necesario aumentar. No se deben utilizar cables de tamaño insuficiente.

En nuestra web podrás encontrar una CALCULADORA para calcular la sección de los cables. Para estar seguro, considere siempre una medida más de la que muestra la calculadora.

Un cable con una sección pequeña puede provocar, en primer lugar, problemas de seguridad. Además, habrá una disminución generalizada en el rendimiento de todo el sistema eléctrico. Caída de alta tensión. Dispersión del calor.

Todas las conexiones deben ser seguras. No apriete los tornillos con los dedos, utilice los accesorios adecuados. Si un cable o perno está caliente, si el inversor se desconecta demasiado pronto, esto sucede porque probablemente los cables son de tamaño insuficiente y/o los pernos no están bien apretados.



BUSBAR

Evite conectar varios cables al mismo punto. Utilice una barra colectora que pueda soportar la carga actual que utiliza. El uso de barras colectoras hace que las conexiones sean más limpias y seguras. El

El trabajo correcto es como se debe hacer. No muchos necesitan estar conectados cables en los polos de la batería, siempre es mejor utilizar barras colectoras.

FUSIBLES

Al igual que con los cables, recuerda utilizar también fusibles certificados del tamaño correcto.

Utilizando fusibles conmutados puede aislar fácilmente partes del sistema cuando necesite realizar mantenimiento.



USO Y MANTENIMIENTO



CARGA Y DESCARGA

No utilice accesorios modificados o dañados.

Si la batería está completamente descargada, recárguela dentro de un mes.

Corriente de carga: no debe ser superior a la corriente de carga máxima especificada en la descripción del producto.

Voltaje de carga: Debe ajustarse de acuerdo con el voltaje de carga especificado en la descripción del producto.

Autodescarga inferior al 3% mensual.

Las baterías de litio no requieren mantenedores de carga.

No es necesario mantener cargadas las baterías de litio durante los períodos de inactividad.

Utilice un seccionador de batería para eliminar cualquier consumo durante los períodos de inactividad.

CC/CV Utilice corriente y voltaje de carga constantes.

Corriente de descarga: no debe ser superior a la corriente máxima de descarga (continua e impulsiva) indicada en la ficha técnica del producto.

No utilice la batería para arrancar motores no eléctricos.



MANTENIMIENTO

Guarde la batería en un área fresca, seca y bien ventilada. No almacene la batería con carga máxima durante mucho tiempo. Se recomienda almacenarlo con una carga del 40-80%.

Almacenar en ambientes no expuestos a fuentes de calor o luz solar directa.

No guarde la batería cerca de materiales inflamables.

Almacenar en ambientes a temperaturas entre 0°C y 35°C.

ADVERTENCIAS

La batería no debe abrirse. Riesgo eléctrico.

Sólo el personal del Centro de Servicio Técnico está autorizado a abrir la batería.

Evite cortocircuitos. No invierta la polaridad de la batería.

No exponga la batería a esfuerzos mecánicos excesivos.

No sumerja las baterías con fugas en agua.

No conecte la batería LiFePO₄ a baterías de diferente capacidad/tecnología, ni a baterías LiFePO₄ de otras marcas.

Mantener fuera del alcance de los niños.

No tirar al medio ambiente.





LITÃO.TIENDA

NOTE

<https://LITIO.TIENDA>



NOTE

<https://LITIO.TIENDA>



NOTE

<https://LITIO.TIENDA>





Baterias LiFePO4 desde 2015

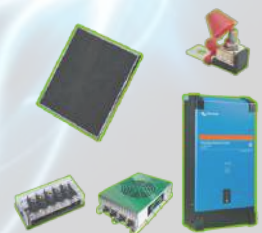
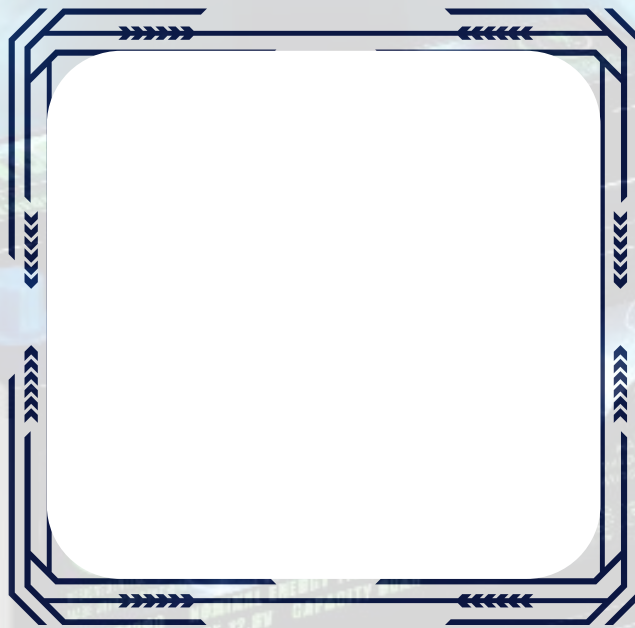

**TU TIENDA FIABLE
PARA ENERGÍA INAGOTABLE**

<https://litio.store>

LITIO STORE SRL - VIA GIOTTO, 2, 06028, SIGILLO (PG), ITALIA