



FCC Supplier's Declaration of Conformity (SDoC) Test Report

For

Huoming Technology(Guangdong) Co., Ltd.

DESK LAMP

Test Model: HWT-01A

Prepared for : Huoming Technology(Guangdong) Co., Ltd.
Address : Unit 3501, 35 / F, HaiJunda Plaza, Guizhou Avenue, Zhenhua
community, Ronggui, Shunde District, Foshan City, Guangdong
Province, China

Prepared by : Shenzhen Southern LCS Compliance Testing Laboratory Ltd.
Address : 101-201, No.39 Building, Xialang Industrial Zone, Heshuikou
Community, Matian Street, Guangming District, Shenzhen, China

Tel : (+86)755-29871520
Fax : (+86)755-29871521
Web : www.LCS-cert.com
Mail : webmaster@LCS-cert.com

Date of receipt of test sample : September 24, 2022
Number of tested samples : 1
Serial number : Prototype
Date of Test : September 24, 2022 - October 12, 2022
Date of Report : October 12, 2022



**FCC SDoC TEST REPORT****CFR47 FCC Part 15 Subpart B**

Radio Frequency Devices - Unintentional Radiators

Report Reference No.....: **LCS220406077BE**

Date of Issue.....: October 12, 2022

Testing Laboratory Name.....: **Shenzhen Southern LCS Compliance Testing Laboratory Ltd.**

Address.....: 101-201, No.39 Building,Xialang Industrial Zone, Heshuikou Community, Matian Street,Guangming District, Shenzhen, China.

Testing Procedure.....: Full application of Harmonised standards
Partial application of Harmonised standards
Other standard testing method Applicant's Name.....: **Huoming Technology(Guangdong) Co., Ltd.**

Address.....: Unit 3501, 35 / F, HaiJunda Plaza, Guizhou Avenue, Zhenhua community, Ronggui, Shunde District, Foshan City, Guangdong Province, China.

Test Specification:Standard.....: CFR47 FCC Part 15 Subpart B
ANSI C63.4-2014

Test Report Form No.....: SLCSEMC-2.3

TRF Originator.....: Shenzhen Southern LCS Compliance Testing Laboratory Ltd.

Master TRF.....: Dated 2016-08

Shenzhen Southern LCS Compliance Testing Laboratory Ltd. All rights reserved.

This publication may be reproduced in whole or in part for non-commercial purposes as long as the Shenzhen Southern LCS Compliance Testing Laboratory Ltd. is acknowledged as copyright owner and source of the material. Shenzhen Southern LCS Compliance Testing Laboratory Ltd. takes no responsibility for and will not assume liability for damages resulting from the reader's interpretation of the reproduced material due to its placement and context.

Equipment Under Test.....: **DESK LAMP**

Trademark.....: Honeywell

Test Model/Type.....: HWT-01A

Rating.....: Input of adapter: 100-240V ~, 50/60Hz
Input of LED module: 24V=, 0,33A, 8WResults: **PASS****Compiled by:**

Amy Liu / Engineer

Supervised by:

Aimee Yang / Technique Director

Approved by:

Dm Gu / Manager



Shenzhen Southern LCS Compliance Testing Laboratory Ltd.

101-201, No. 39 Building, Xialang Industrial Zone, Heshuikou Community, Matian Street, Guangming District, Shenzhen, China.

Tel: +(86) 0755-82591330 | E-mail: webmaster@lcs-cert.com | Web: www.lcs-cert.com.

Scan code to check authenticity.



FCC SDoC - TEST REPORT

Test Report No.....: LCS220406077BE

Applicant.....:	Huoming Technology(Guangdong) Co., Ltd.
Address.....:	Unit 3501, 35 / F, HaiJunda Plaza, Guizhou Avenue, Zhenhua community, Ronggui, Shunde District, Foshan City, Guangdong Province, China
Telephone.....:	/
Fax.....:	/
Manufacturer.....:	Walsun Lighting (Huizhou) Co., Ltd.
Address.....:	Plant A, NO.27, Xikeng Industrial zone, Huihuan Street, Zhongkai National Hitech Industrial Development District, Huizhou city, Guangdong, China
Telephone.....:	/
Fax.....:	/
Factory.....:	Walsun Lighting (Huizhou) Co., Ltd.
Address.....:	Plant A, NO.27, Xikeng Industrial zone, Huihuan Street, Zhongkai National Hitech Industrial Development District, Huizhou city, Guangdong, China
Telephone.....:	/
Fax.....:	/

The applicant and manufacturer information, product name, model, trademark and other information in this report are all provided by the applicant, and this laboratory is not responsible for verifying its authenticity.

The test report merely corresponds to the test sample.

It is not permitted to copy extracts of these test result without the written permission of the test laboratory.





ENVIRONMENTAL CONDITIONS

The climatic conditions during the test are within the limits specified by the manufacturer for the operation of the EUT and the test equipment. the climatic conditions during the test were in the following Limits:

Ambient temperature	15°C - 30°C
Relative Humidity air	30% - 75%
Atmospheric pressure	86 kPa - 106 kPa

Climate values will be recorded and recorded separately if specifically required in the base standard or application product/product series standard.

POSSIBLE TEST CASE VERDICTS

Test cases does not apply to test object	N/A
Test object does meet requirement	P(Pass) / PASS
Test object does not meet requirement	F(Fail) / FAIL
Not measured	N/M

DEFINITION OF SYMBOLS USED IN THIS TEST REPORT

<input checked="" type="checkbox"/> Indicate that the conditions, standards or equipment listed is applicable to this report / test / EUT.
<input type="checkbox"/> Indicate that the conditions, standards or equipment listed is not applicable to this report / test / EUT.

REVISION HISTORY

Revision	Issue Date	Revision Content	Revised by
000	October 12, 2022	Initial Issue	-

Remark:
000) : “---”





TABLE OF CONTENTS

- 1. GENERAL INFORMATION6**
 - 1.1. General Description of The Item(s) 6
 - 1.2. Operating Mode(s) Used of Tests 7
 - 1.3. Support / Auxiliary Equipment For The EUT 7
 - 1.4. Description of Test Facility7
- 2. STATEMENT OF THE MEASUREMENT UNCERTAINTY 8**
- 3. MEASURING DEVICES AND TEST EQUIPMENT 9**
- 4. VERDICT SUMMARY SECTION 9**
 - 4.1. Standard(s) 10
 - 4.2. Overview of Results 10
- 5. EMISSION TESTS 11**
 - 5.1. Conducted Disturbance 11
 - 5.2. Radiated Disturbance 12
- ANNEX A - TEST RESULTS 14**
- ANNEX B - TEST PHOTOS 18**
- ANNEX C - EXTERNAL AND INTERNAL PHOTOS OF THE EUT 19**





1. GENERAL INFORMATION

1.1. GENERAL DESCRIPTION OF THE ITEM(S)

Equipment Under Test	DESK LAMP
Test Model/Type	HWT-01A
Additional Models/Type	-
Description of Model difference	-
Rating	Input of adapter: 100-240V ~, 50/60Hz Input of LED module: 24V ---, 0,33A, 8W
Classification of device	<input type="checkbox"/> Class A <input checked="" type="checkbox"/> Class B





1.2. OPERATING MODE(S) USED OF TESTS

During the tests, the following operating mode(s) has(have) been used.

Operating Mode	Operating Mode description	Used for testing
1	Lighting on mode	<input checked="" type="checkbox"/>
2	Bluetooth	<input type="checkbox"/>
3	HDMI	<input type="checkbox"/>
4	Full load	<input type="checkbox"/>

1.3. SUPPORT / AUXILIARY EQUIPMENT FOR THE EUT

EUT has been tested using the following auxiliary equipment :

Auxeq	Model/Type	Manufacturer	Supplied by
--			

1.4. DESCRIPTION OF TEST FACILITY

Test Location	Shenzhen Southern LCS Compliance Testing Laboratory Ltd. 101-201, No.39 Building,Xialang Industrial Zone, Heshuikou Community, Matian Street, Guangming District, Shenzhen, China. CNAS Registration Number is L10160.
Date of receipt of test item	September 24, 2022
Date(s) of performance of test	September 24, 2022 - October 12, 2022





2. STATEMENT OF THE MEASUREMENT UNCERTAINTY

The data and results referenced in this document are true and accurate. The reader is cautioned that there may be errors within the calibration limits of the equipment and facilities. The measurement uncertainty was calculated for all measurements listed in this test report according to CISPR 16 - 4 "Specification for radio disturbance and immunity measuring apparatus and methods - Part 4: Uncertainty in EMC Measurements" and is documented in the LCS quality system according to DIN EN ISO/IEC 17025. Furthermore, component and process variability of devices similar to that tested may result in additional deviation. The manufacturer has the sole responsibility of continued compliance of the device.

Measurement	Uncertainty (U_{lab})	Uncertainty (U_{CISPR})
Conducted disturbance (9kHz - 150kHz)	± 1.40 dB	± 4.0 dB
Conducted disturbance (150kHz - 30MHz)	± 2.80 dB	± 3.6 dB
Radiated disturbance (30MHz - 200MHz)	± 4.66 dB	± 5.2 dB
Radiated disturbance (200MHz - 1GHz)	± 4.64 dB	± 5.0 dB

Supplementary information:

The reported expanded uncertainty of measurement is stated as the standard uncertainty of measurement multiplied by the coverage factor of $k=2$, which for a normal distribution corresponds to a coverage probability of approximately 95%.





3. MEASURING DEVICES AND TEST EQUIPMENT

CONDUCTED DISTURBANCE						
Item	Test equipment	Manufacturer	Model No.	Serial No.	Cal Date	Due Date
1	EMI Test Receiver	R&S	ESCI	101142	2022-05-05	2023-05-04
2	10dB Attenuator	SCHWARZBECK	VTSD9561-F	9561-F159	2022-05-05	2023-05-04
3	Artificial Mains Network	SCHWARZBECK	NSLK8127	8127716	2022-05-05	2023-05-04
4	EMI Test Software	EZ	EZ_EMG	N/A	/	/
5	Asymmetric Artificial Network	SCHWARZBECK	NTFM 8158	NTFM8158#120	2022-05-05	2023-05-04
6	Voltage Probe	SCHWARZBECK	KT 9420	9420401	2022-05-05	2023-05-04
7	No. 2 shielded Room	CHENGYU	843	/	2020-06-16	2023-06-16

RADIATED DISTURBANCE (above 30MHz)						
Item	Test equipment	Manufacturer	Model No.	Serial No.	Cal Date	Due Date
1	3m Semi Anechoic Chamber	SIDT FRANKONIA	SAC-3M	03CH03-HY	2021-06-15	2024-06-15
2	EMI Test Receiver	R&S	ESCI3	101010	2022-05-05	2023-05-04
3	Spectrum Analyzer	Agilent	N9020A	MY49100699	2022-05-05	2023-05-04
4	Log-periodic Antenna	SCHWARZBECK	VULB9163	5094	2022-05-20	2025-05-19
5	Horn Antenna	ETS-LINDGREN	3115	00034771	2022-05-20	2025-05-19
6	EMI Test Software	EZ	EZ_EMG	N/A	/	/
7	Controller	KGS	M4U450	/	/	/





4. VERDICT SUMMARY SECTION

This chapter present an overview of the standards and results. Refer the next chapter for details of measured test results and applied test levels.

4.1. STANDARD(S)

CFR47 FCC Part 15 Subpart B - Radio frequency devices Subpart B - Unintentional radiators.

ANSI C63.4-2014 - American national standard for methods of measurement of radio noise emissions from low-voltage electrical and electronic equipment in the range of 9 kHz to 40 GHz.

4.2. OVERVIEW OF RESULTS

EMISSION TESTS - CFR47 FCC Part 15 Subpart B		
Requirement - Test case	Limit	Verdict
Conducted Disturbance	Clause 15.107	PASS
Radiated Disturbance	Clause 15.109	PASS

Supplementary information : ---



5. EMISSION TESTS

5.1. CONDUCTED DISTURBANCE

Standard	CFR47 FCC Part 15 Subpart B
Referenced Standard(s)	ANSI C63.4-2014

Disturbance voltage limits at AC power ports of Class B equipment

Frequency range [MHz]	Limit: Quasi-peak [dB(μV)]	Limit: Average[dB(μV)]	IF BW
0,15 - 0,5	66 - 56	56 - 46	9 kHz
0,5 - 5,0	56	46	
5,0 - 30	60	50	

1) At the transition frequency, the lower limit applies.

Disturbance voltage limits at AC power ports of Class A equipment

Frequency range [MHz]	Limit: Quasi-peak [dB(μV)]	Limit: Average[dB(μV)]	IF BW
0,15 - 0,5	79	66	9 kHz
0,5 - 30	73	60	

1) At the transition frequency, the lower limit applies.

Test configuration

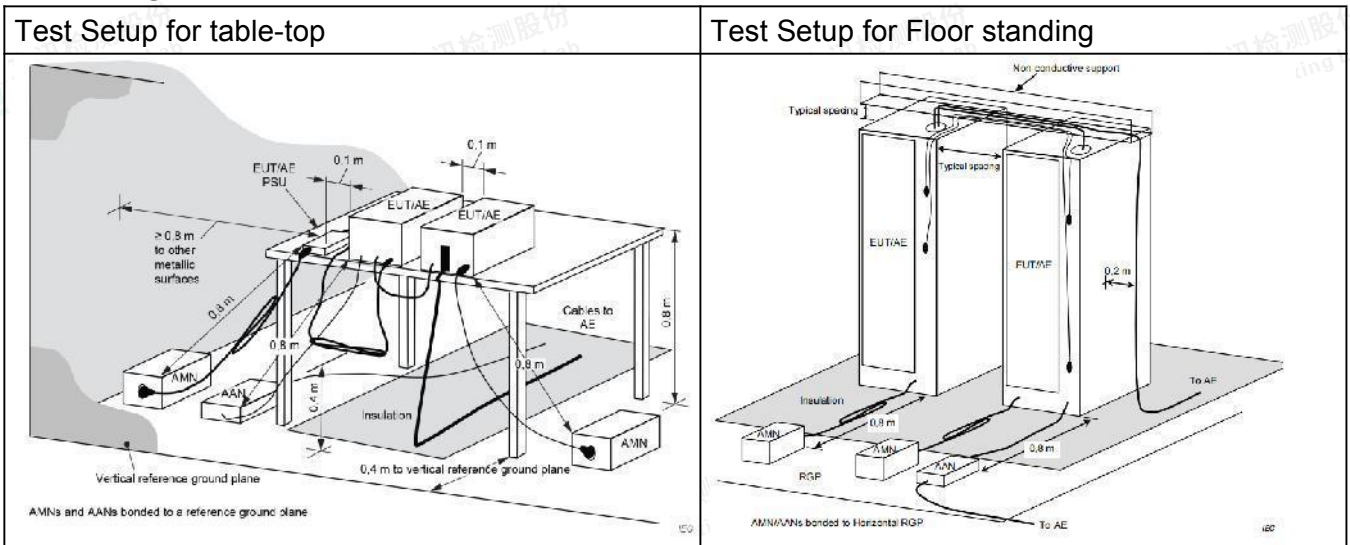

Test Procedure Description

For Table-top, EUT shall be placed at $(0,8 \pm 0,05)$ m above the reference plane of the test site selected for measurement. for Floor standing, EUT shall be placed at $(0,12 \pm 0,04)$ m above the reference plane of the test site selected for measurement.and connected to the AC mains through artificial mains network (LISN). EUT is powered by V-type artificial power network,and the distance from LISN or is 0,8m. the part of the EUT power cord exceeding 0,8m folds in parallel to form a 0,3-0,4 m eights harness.

Test Results refer to Annex A.1



5.2. RADIATED DISTURBANCE

Standard	CFR47 FCC Part 15 Subpart B
Referenced Standard(s)	ANSI C63.4-2014
Test method	Semi Anechoic Chamber (SAC)

SAC Radiated disturbance limit for Class B equipment (3 m distance)

Frequency range [MHz]	Limit: Quasi-peak		IF BW
	[$\mu\text{V}/\text{m}$]	[dB($\mu\text{V}/\text{m}$)]	
30 - 88	100	40	120 KHz
88 - 216	150	43.5	
216 - 960	200	46	
960 - 1000	500	54	

SAC Radiated disturbance limit for Class A equipment (10 m distance)

Frequency range [MHz]	Limit: Quasi-peak		IF BW
	[$\mu\text{V}/\text{m}$]	[dB($\mu\text{V}/\text{m}$)]	
30 - 88	90	39	120 KHz
88 - 216	150	43.5	
216 - 960	210	46.5	
960 - 1000	300	49.5	

- 1) At the transition frequency, the lower limit applies.
- 2) Emission level (dB) μV = 20 log Emission level $\mu\text{V}/\text{m}$.

Test configuration

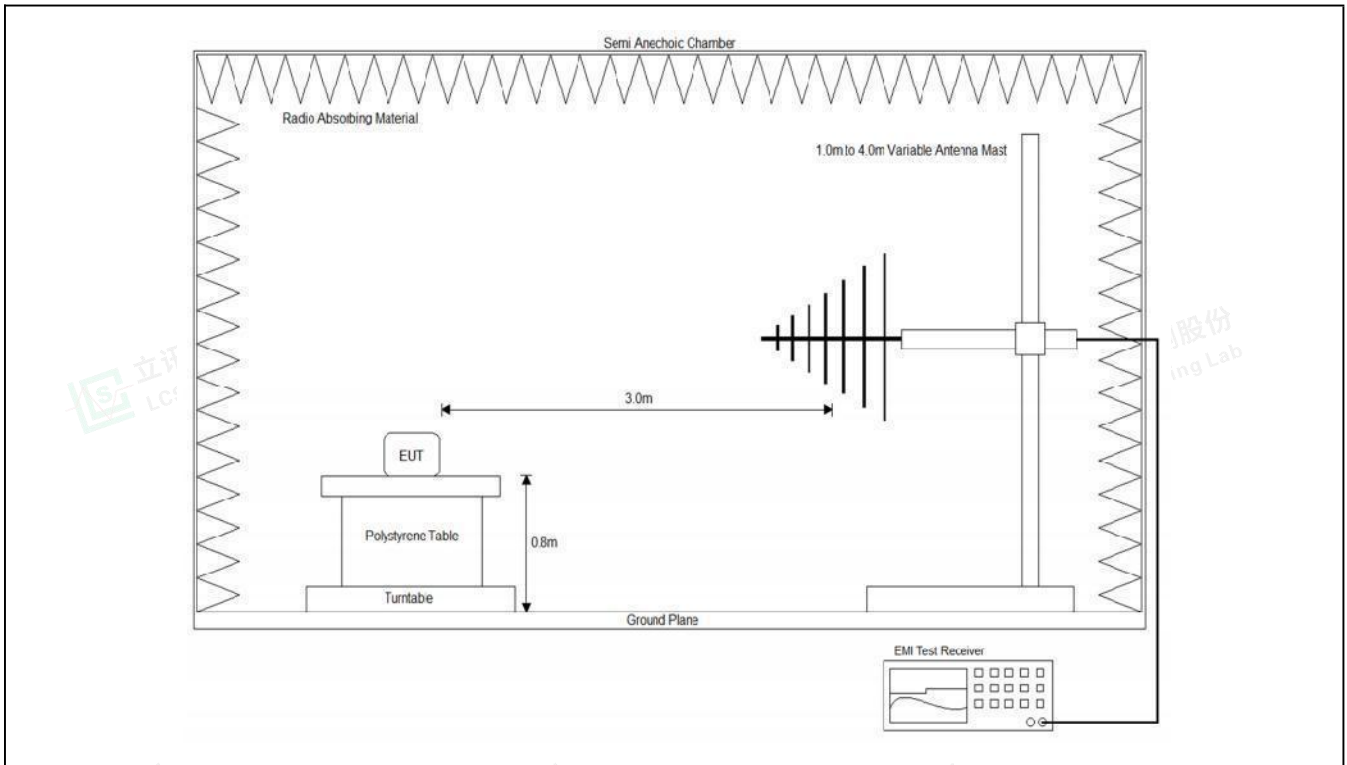



Test Procedure Description

Radiated Emissions were measured 3 metres away from the EUT in the Semi Anechoic Chamber facility, which is an ANSI C63.4 compliant semi-anechoic chamber with ground plane. The EUT was placed on a non-conductive table, at a height of 0.8m above the ground plane. the turntable can rotate 360 degrees to determine the position of the maximum emission level. the EUT is set 3 meters away from the receiving antenna, which is mounted on an antenna tower. the antenna can be moved up and down from 1 to 4 meters to find out the maximum emission level. Log-periodic antenna or horn antenna is used as a receiving antenna. both horizontal and vertical polarization of the antenna is set on test.

Test Results refer to Annex A.2





ANNEX A - TEST RESULTS

A.1. CONDUCTED DISTURBANCE TEST RESULTS

Environmental Conditions	23.9°C, 56% RH
Model	HWT-01A
Operating mode	Mode 1 (worst case)
Test voltage	AC120V/60Hz
Test engineer	Sam Chen
Pol	Line

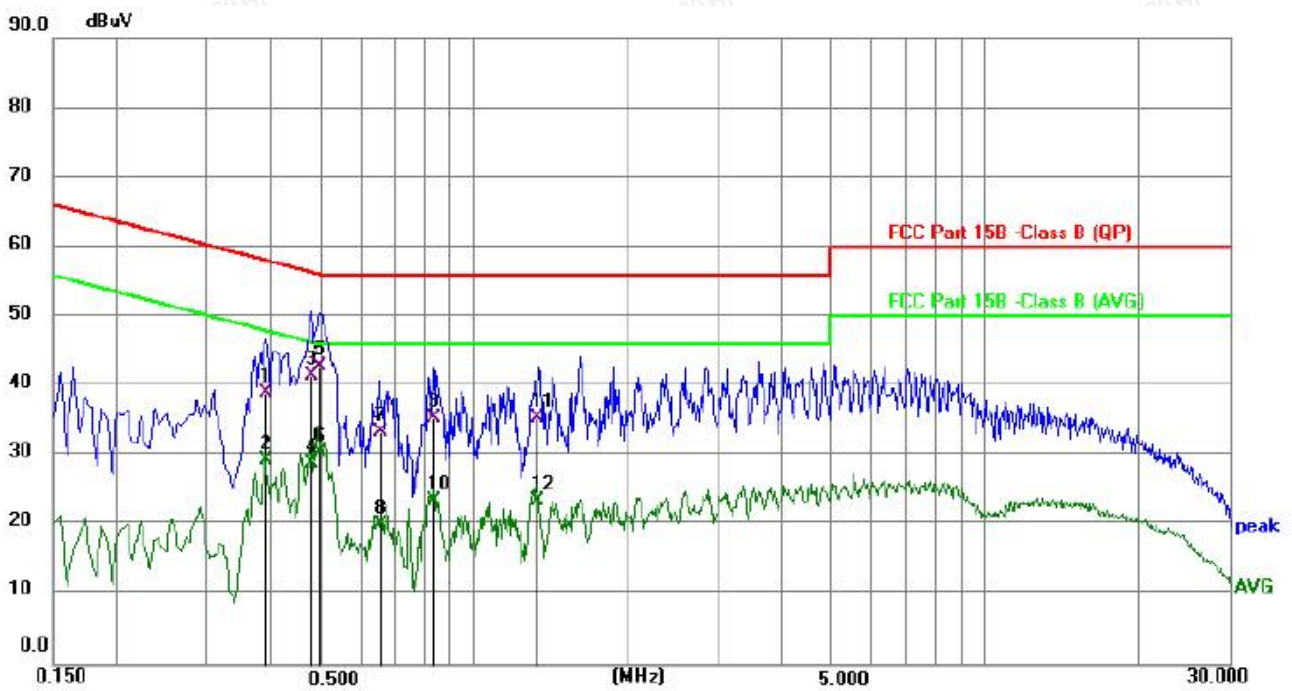

No.	Mk.	Freq. MHz	Reading Level	Correct Factor dB	Measure- ment dBuV	Limit dBuV	Over dB	Detector	Comment
1		0.3890	28.82	10.20	39.02	58.09	-19.07	QP	
2		0.3890	19.11	10.20	29.31	48.09	-18.78	AVG	
3		0.4801	31.36	10.20	41.56	56.34	-14.78	QP	
4		0.4801	18.70	10.20	28.90	46.34	-17.44	AVG	
5	*	0.4983	32.57	10.20	42.77	56.03	-13.26	QP	
6		0.4983	20.39	10.20	30.59	46.03	-15.44	AVG	
7		0.6549	23.14	10.20	33.34	56.00	-22.66	QP	
8		0.6549	10.03	10.20	20.23	46.00	-25.77	AVG	
9		0.8340	25.25	10.20	35.45	56.00	-20.55	QP	
10		0.8340	13.26	10.20	23.46	46.00	-22.54	AVG	
11		1.3315	25.17	10.20	35.37	56.00	-20.63	QP	
12		1.3315	13.33	10.20	23.53	46.00	-22.47	AVG	





Environmental Conditions	23.9°C, 56% RH
Model	HWT-01A
Operating mode	Mode 1 (worst case)
Test voltage	AC120V/60Hz
Test engineer	Sam Chen
Pol	Neutral

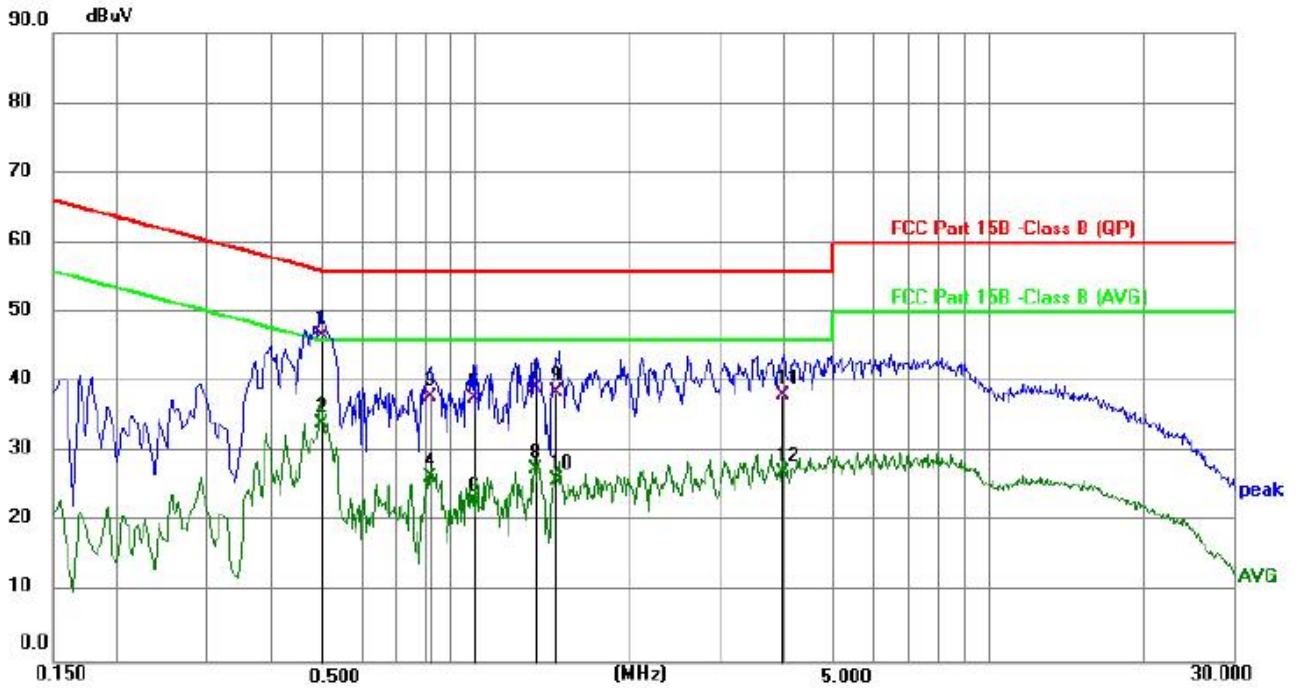

No.	Mk.	Freq. MHz	Reading Level	Correct Factor dB	Measure- ment dBuV	Limit dBuV	Over dB	Detector	Comment
1	*	0.5000	36.50	10.20	46.70	56.00	-9.30	QP	
2		0.5000	23.96	10.20	34.16	46.00	-11.84	AVG	
3		0.8177	27.69	10.20	37.89	56.00	-18.11	QP	
4		0.8177	16.27	10.20	26.47	46.00	-19.53	AVG	
5		0.9941	27.54	10.20	37.74	56.00	-18.26	QP	
6		0.9941	12.67	10.20	22.87	46.00	-23.13	AVG	
7		1.3094	29.10	10.20	39.30	56.00	-16.70	QP	
8		1.3094	17.32	10.20	27.52	46.00	-18.48	AVG	
9		1.4410	28.31	10.20	38.51	56.00	-17.49	QP	
10		1.4410	15.88	10.20	26.08	46.00	-19.92	AVG	
11		3.9798	28.02	10.20	38.22	56.00	-17.78	QP	
12		3.9798	16.85	10.20	27.05	46.00	-18.95	AVG	





A.2. RADIATED DISTURBANCE TEST RESULTS

Environmental Conditions	23.2°C, 52% RH
Model	HWT-01A
Operating mode	Mode 1 (worst case)
Test voltage	AC120V/60Hz
Test engineer	Sam Chen
Pol	Vertical

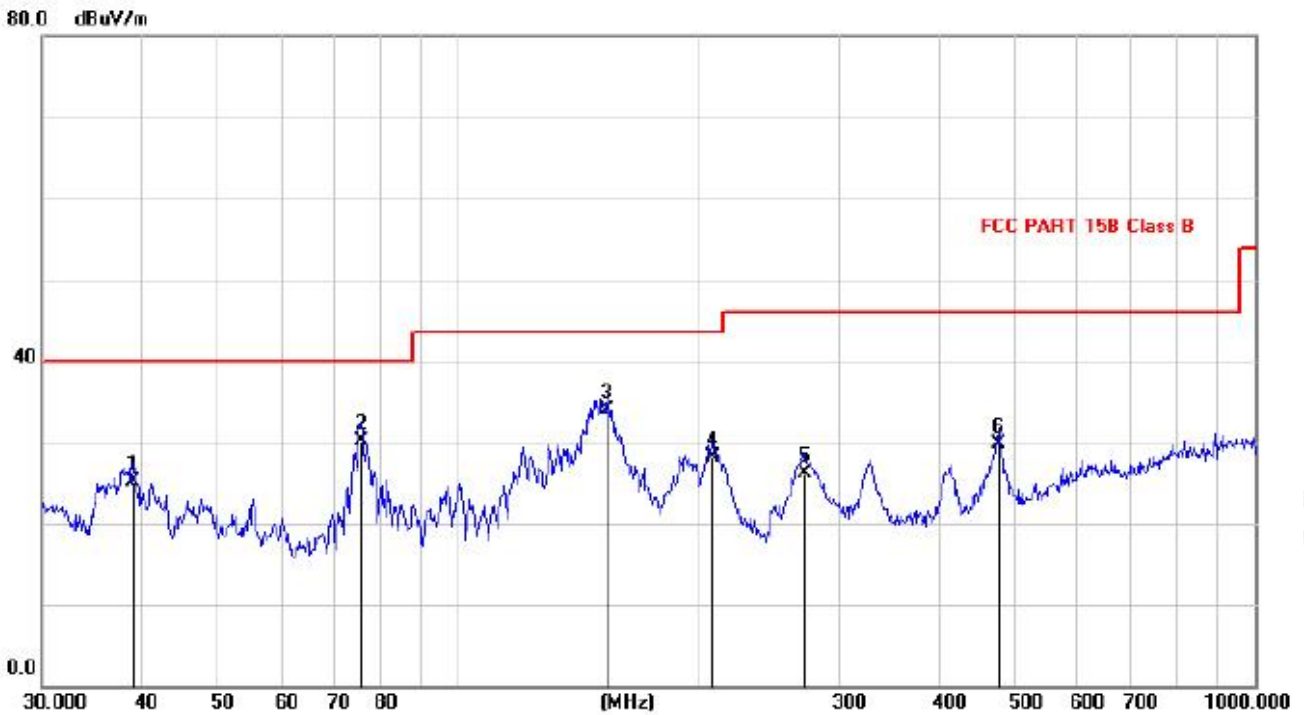

No.	Mk.	Freq. MHz	Reading Level dBuV	Correct Factor dB/m	Measure- ment dBuV/m	Limit dBuV/m	Margin dB	Detector	Antenna Height cm	Table Degree	Comment
1		39.1444	13.27	11.86	25.13	40.00	-14.87	QP			
2		75.4794	20.45	9.70	30.15	40.00	-9.85	QP			
3	*	154.2786	22.95	10.91	33.86	43.50	-9.64	QP			
4		208.6717	16.51	11.58	28.09	43.50	-15.41	QP			
5		272.0391	12.52	13.49	26.01	46.00	-19.99	QP			
6		476.5424	11.96	17.70	29.66	46.00	-16.34	QP			





Environmental Conditions	23.2°C, 52% RH
Model	HWT-01A
Operating mode	Mode 1 (worst case)
Test voltage	AC120V/60Hz
Test engineer	Sam Chen
Pol	Horizontal

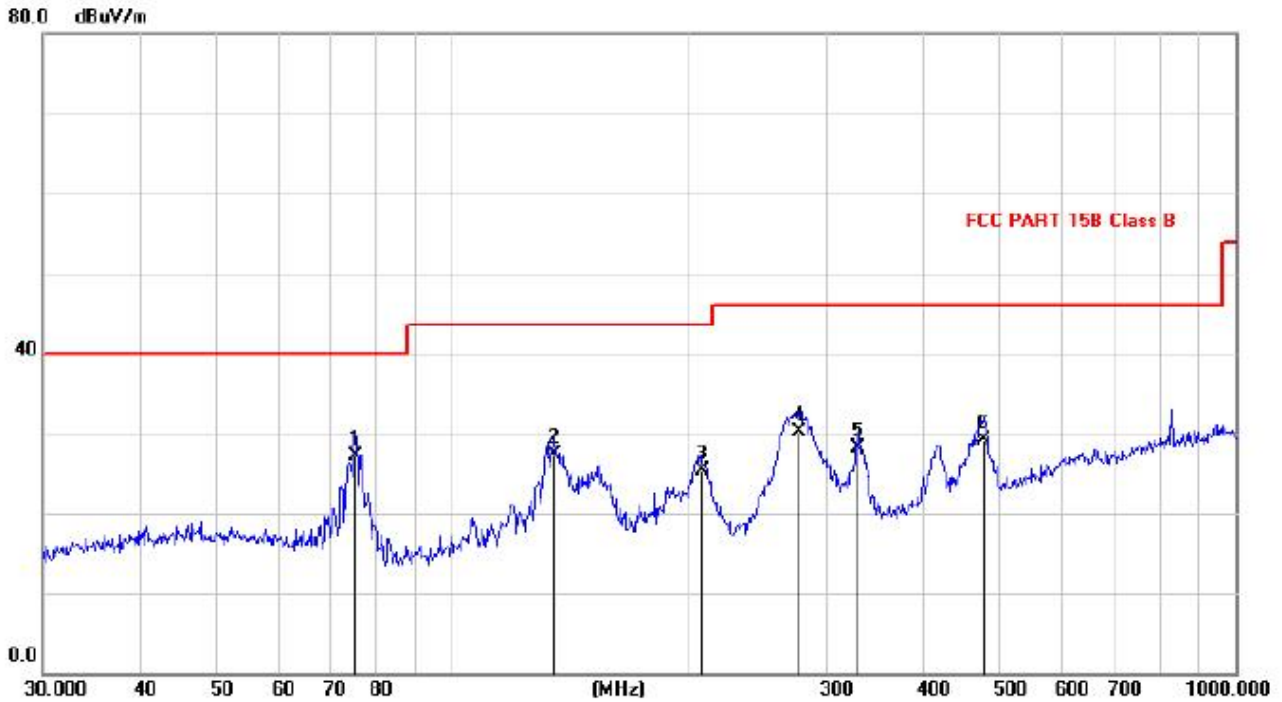

No.	Mk.	Freq.	Reading Level	Correct Factor	Measurement	Limit	Margin	Antenna Height	Table Degree	
		MHz	dBuV	dB/m	dBuV/m	dBuV/m	dB	cm	degree	Comment
1	*	75.3472	17.52	9.66	27.18	40.00	-12.82	QP		
2		135.4468	16.47	10.90	27.37	43.50	-16.13	QP		
3		208.1236	13.98	11.35	25.33	43.50	-18.17	QP		
4		277.8231	16.76	13.39	30.15	46.00	-15.85	QP		
5		330.1949	13.08	15.00	28.08	46.00	-17.92	QP		
6		476.3335	11.26	17.90	29.16	46.00	-16.84	QP		



ANNEX B - TEST PHOTOS

B.1. Conducted Disturbance

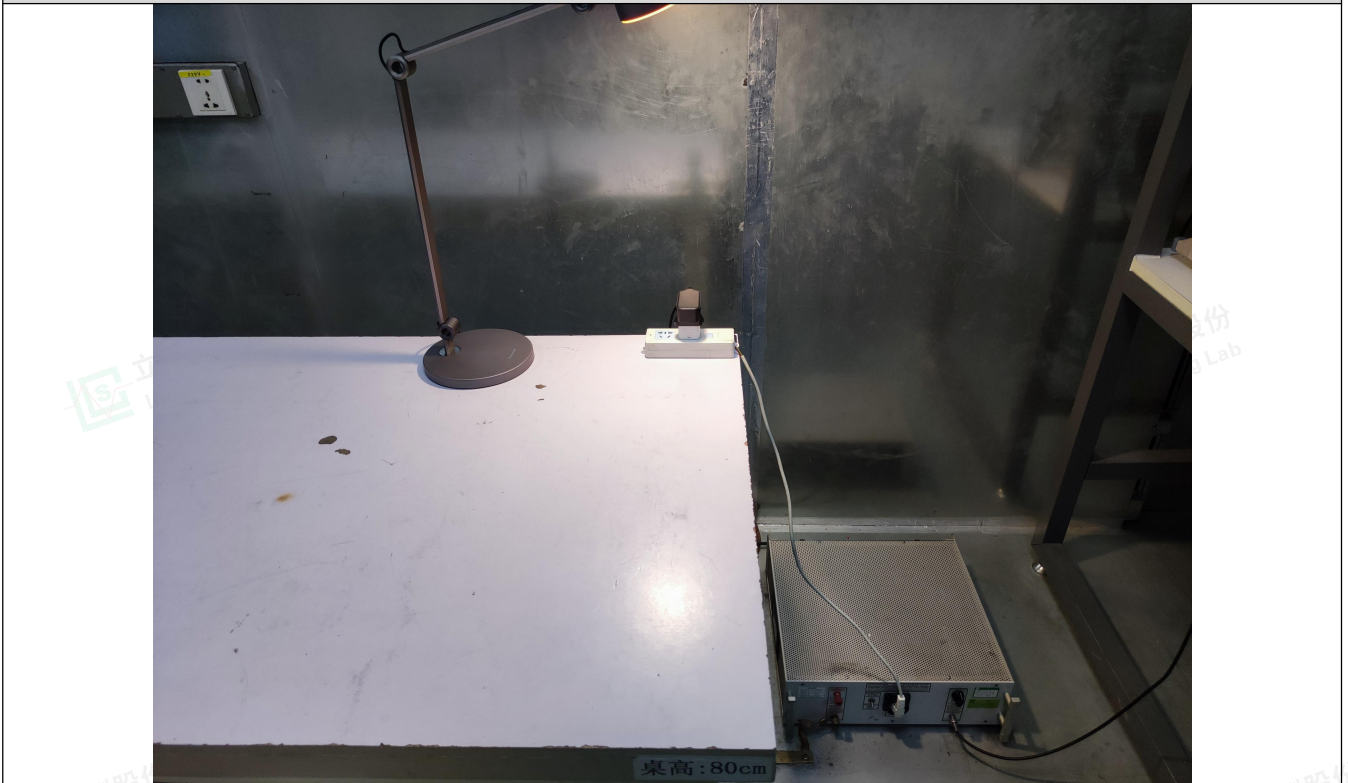

B.2. Radiated Disturbance

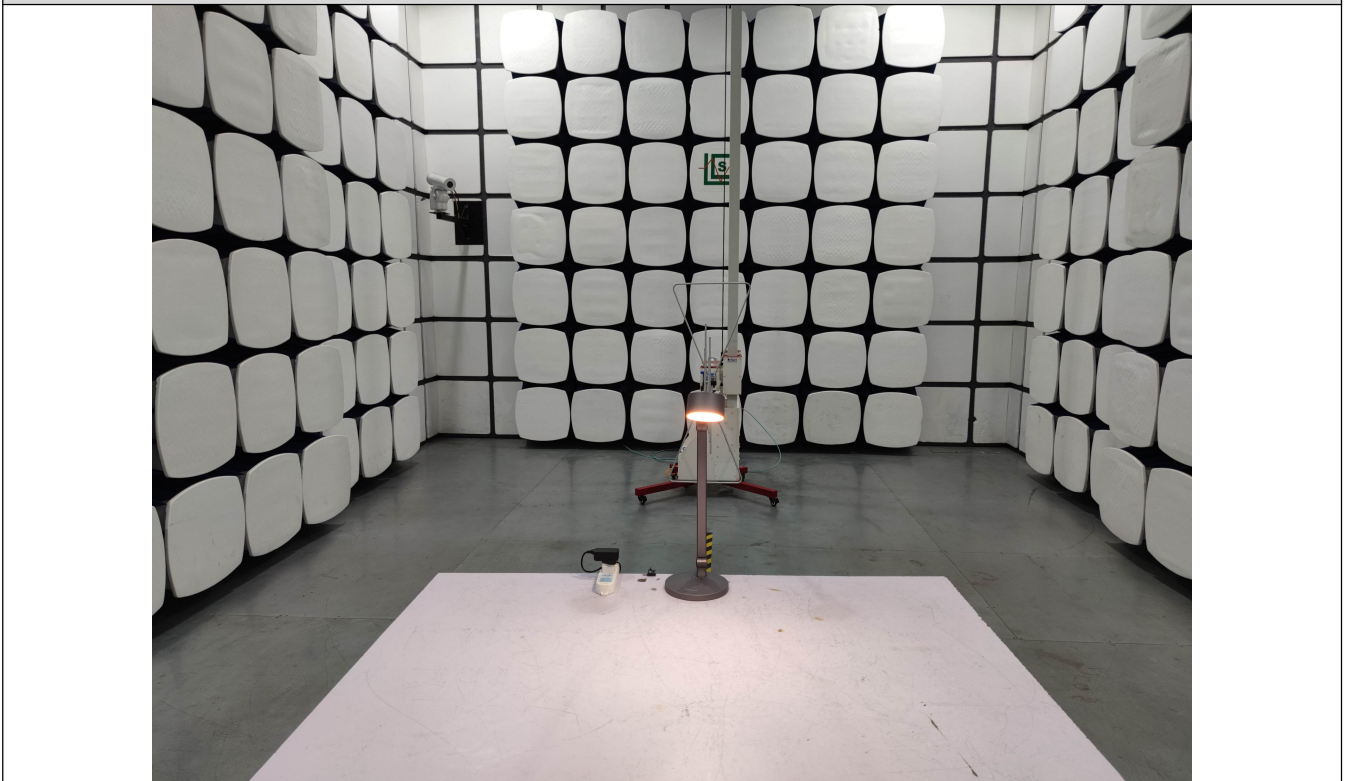

ANNEX C - EXTERNAL AND INTERNAL PHOTOS OF THE EUT

The photographs show the equipment under test.



Figure. 1 (HWT-01A)



Figure. 2 (HWT-01A)





Figure. 3



Figure. 4





Figure. 5



Figure. 6



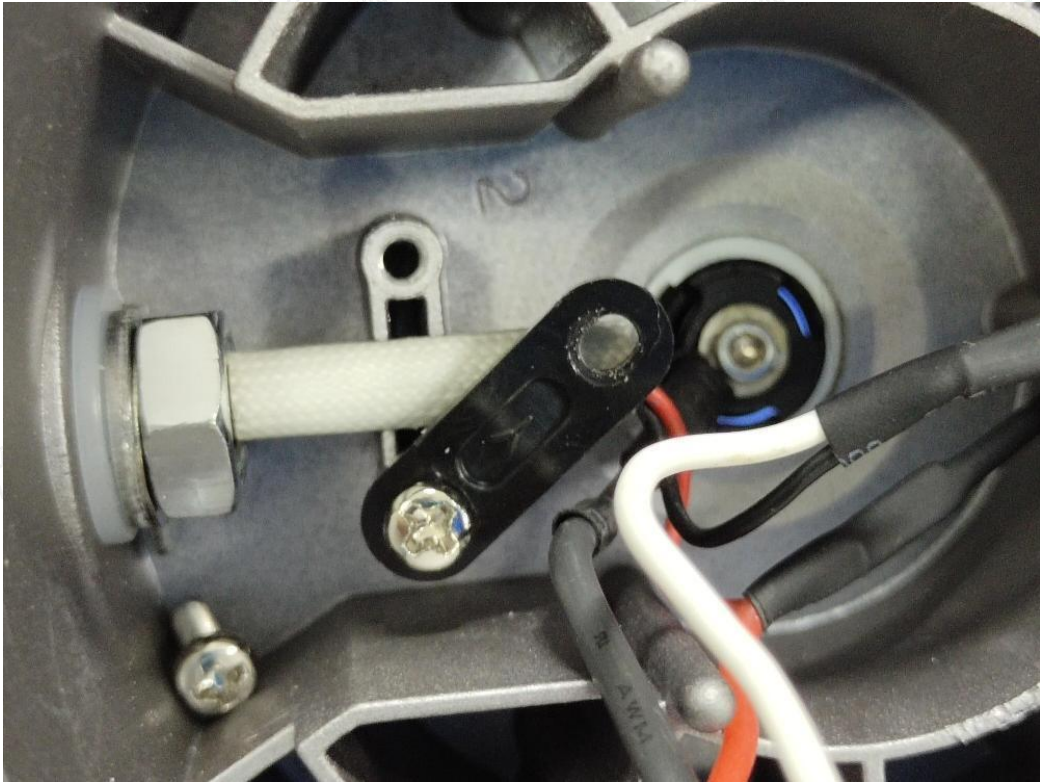
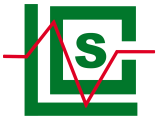

Figure. 7



Figure. 8

----- END -----

