

# FOGATTI

# Instruction Manual

## InstaShower Series RV Tankless Water Heater

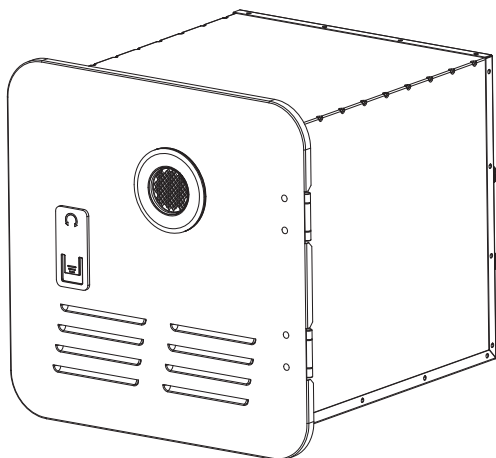

CSA/ANSI Z21.10.3:19 • CSA 4.3:19

This water heater is specifically designed for RV users,  
DC 12V operating voltage with propane gas source.

TEL: 877-216-1818 (8:30am-5:00pm EST Monday-Friday)

E-mail: [us@fogatti.com](mailto:us@fogatti.com)



**WARNING**

If the information in these instructions is not followed exactly, a fire or explosion may result causing property damage, personal injury or death.

- Do not store or use gasoline or other flammable vapors and liquids in the vicinity of this or any other appliance.
- **WHAT TO DO IF YOU SMELL GAS**
- Evacuate all persons from the vehicle.
- Shut off the gas supply at the gas container or source.
- Do not touch an electrical switch, or use any phone or radio in the vehicles.
- Do not start the vehicle's engine or electric generator.
- Contact the nearest gas supplier or qualified service technician for repairs.
- If you can not reach a gas supplier or qualified service technician, contact the nearest fire department.
- Do not turn on the gas supply until the gas leak(s) has been repaired.
- Installation and service must be performed by a qualified installer, service agency or the gas supplier.

# Preface

Thank you for using our RV instant gas water heater. Correct installation and use of this product will bring new enjoyment to your wonderful life. Please read and follow all safety rules before installing and using this heater. Please keep the instructions manual properly for future reference.

## Table of Contents

---

■ Function Introduction and Explanation	01
■ Appearance	02
■ Main Part	03
■ Safety Warnings and Operation Safety Guidelines	05
■ Installation Instructions	07
■ Rv Water Heater Installation Check List	07
■ Prepare For Installation	08
■ Installation Steps	15
■ Operation Instructions	17
■ Fault Assessment and Troubleshooting	19
■ Electrical Schematics	21
■ Product Wiring Diagram	22
■ Maintenance	23
■ Drainage and Storage Instruction	26
■ Antifreeze System	27
■ Antifreeze Tips	28
■ Model and Specifications	29
■ Packing List	30
■ Warranty Card	31

# Function Introduction and Explanation

The water heater is designed with intelligent control system. Simply set the temperature and press the start button for machine detecting the qualify water flow. After ignition, the gas valve invites propane to ignite the burner, then runs steady hot water. The intelligent device detects the entire process, where may shut down gas whenever abnormal failures detected. The water heater is forced exhaust structured. The outside air passing through the air intake grille enters the combustion chamber via anti-dust net. Flue gas or air mixture is discharged outdoor through the small-diameter pipe automatically and safely.

## 1. Digital constant temperature system:

Microcomputer control system, which constitutes the "computer" of the whole machine, which controls the water, electricity of the water heater in a coordinated manner, and does not cause the temperature of the water temperature to fluctuate, satisfying the user's comfort.

**2. Low startup water pressure:** Low startup water pressure making it easier to use.

**3. Flameout protection:** When water heater accidently flames out during operation, the gas supply will be automatically cut off to ensure no leakage.

## 4. Speed changing and wind resistance

**function:** When a blockage of the flue or the smoke is blocked, the built-in microcomputer system will increase the operating speed of the fan and eliminate the generation of harmful gases. When the speed reaches the predetermined maximum speed, the microcomputer system will issue the cease-gas and cease-fire instruction, effectively guarantee safety.

**5. Water and gas linkage control:** When the water supply is interrupted or the water outlet valve is closed, the water heater will automatically stop the combustion and shut down.

**6. Outlet water temperature display:** Enables outlet water temperature display function.

**7. Antifreeze function:** Antifreeze function: When water pipe temperature is lower than  $43^{\circ}\text{F}\pm 2^{\circ}\text{F}$  ( $6\pm 1^{\circ}\text{C}$ ) and wire controller displays "Fd" character, the machine starts ignition and runs a certain load of water from 2 to 5 seconds, until water temperature reaches  $90^{\circ}\text{F}\pm 2^{\circ}\text{F}$  ( $32\pm 1^{\circ}\text{C}$ ). Around 3 minutes, the machine starts self-testing again. When temperature is lower to  $43^{\circ}\text{F}\pm 2^{\circ}\text{F}$  ( $6\pm 1^{\circ}\text{C}$ ) again or antifreeze thermostat control stops working, the water heater starts again with same cycle.

• In the process of starting the antifreeze function, if a fault occurs, the corresponding fault is reported, and the corresponding code is displayed. After 15 minutes, the system automatically clears the fault code. If the antifreeze start condition is fulfilled, the antifreeze will automatically start again, and the cycle continues.

## 8. Error auto-diagnosis and error code display

**function:** Intelligent microcomputer can monitor various safety devices, gas proportional valves and other components at real-time, find faults and timely safety shutdown. Advanced fault code display function makes it easy to use and maintain.



# Appearance

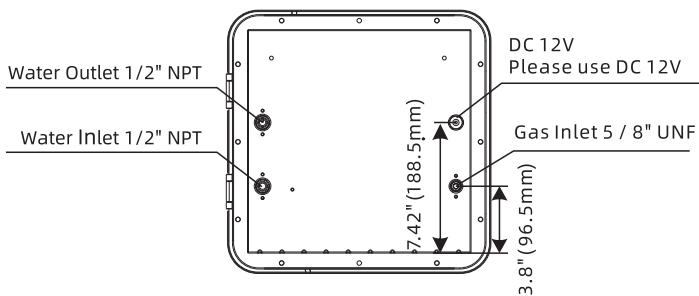
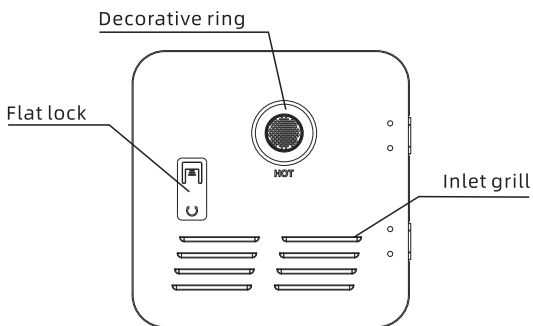
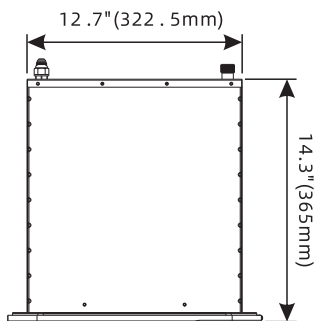
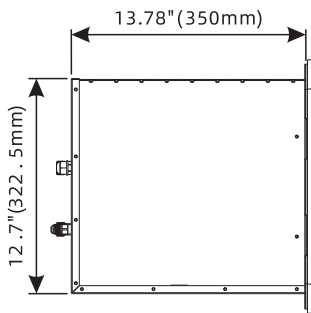
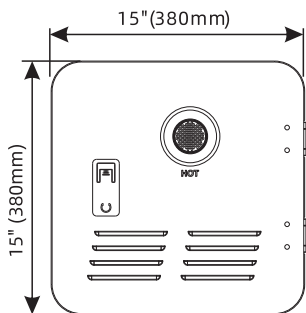

# Main Parts

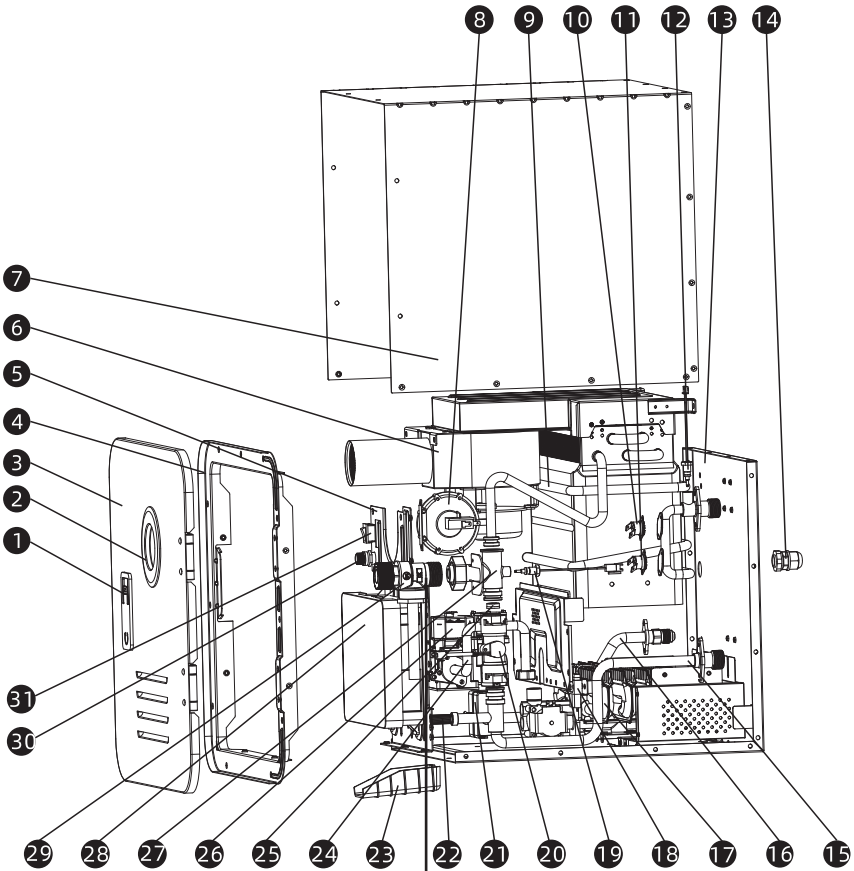

**PS** . If you have purchased our machine with internal relief valve, you do not need to install additional Pressure relief valve on the outside .

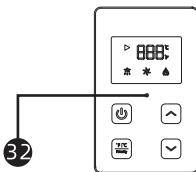

<b>NO.</b>	<b>Name</b>	<b>NO.</b>	<b>Name</b>
1	Flat Lock	17	Burner
2	Decorative Ring	18	Ignition Pin Assembly
3	Front Panel	19	Water Inlet Temperature Probe
4	Blind Flange	20	Water Flow Sensor
5	Fixing Plate	21	Valve Frame
6	Fan Volute Assembly	22	Drainage Screw
7	Upper Enclosure	23	Drain Pan
8	Wind Pressure Switch	24	Connecting Pipe For Burner And Valve
9	Heat Exchanger	25	Flow Regulatur
10	Anti-Freezing Thermostat	26	Gas Proportional Valve
11	Thermostat	27	Tee Joint
12	Water Outlet Temperature Probe	28	Controller
13	Lower Enclosure	29	Pressure Relief Valve
14	Ply-Yarn Drill	30	Fuse Box ( 125V 10A )
15	Water Inlet Assembly	31	ON / OFF Switch
16	Gas Inlet Assembly	32	Wired Controller

# Safety Warnings and Operation Safety Guidelines



Please read the warnings and safety instructions carefully to avoid potential injury or death caused by failed applications.

1. RV instant gas water heater is forbidden from indoor installation. Please only install into RVs supported by independent power source.



2. To prevent fire or explosion accidents, do not place flammable, volatile articles near the water heaters and flue exhaust pipe.

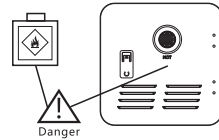

3. During operation and after use of the water heater, the temperature of the flue exhaust pipe and the surrounding parts is high. Please do not touch any of it with your hands to avoid scalding.

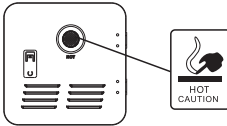

4. To prevent burning, test the water temperature by hand before showering or bathing.



5. Do not modify the water heater in any way. Self-modification is dangerous and will void the warranty.

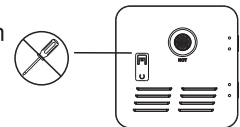

6. When the water heater is not in use for a long period, in order to prevent frost crack on waterway and leaking of the water heater, water within the water heater shall be drained, with water inlet valve, gas supply and power supply turned off. When the ambient temperature is lower than 32°F(0°C), you may either discharge the water in the water heater, or turn on the power supply and open the gas valve to start anti-freezing mode, in preparation for anti-freezing treatment. (For details, refer to the relevant section of the manual.)

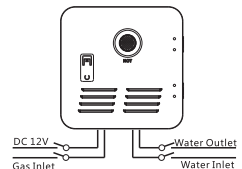

7. During use, please perform regular maintenance as instructed in this manual. Check the exhaust venting pipe and air intake port for blockage, accumulation of snow, ice, or dirt regularly. Ensure the water heater can take in clean air and smoothly discharge the exhaust gas produced by combustion.

8. Water heaters are used only for the supply of hot water and cannot be used for other purposes to prevent accidents.



9. Hot water from water heater is not available for direct drinking purposes.
10. Do not use the battery charger to power or test the water heater. The on-board power supply used by the vehicle-mounted gas water heater must comply with class 2 safety-isolation. Please use a qualified power supply to avoid damage to the water heater.
11. Do not alter the positive grounding system of the water heater.
12. Do not test the water heater with high voltage power unless the water heater power switch is turned off.
13. Do not use a water heater while the vehicle is in motion. While refueling the vehicle, do not use the water heater and turn off the water heater.
14. Pay attention to protect the surrounding buildings when the smoke is discharged.
15. Do not connect the water heater to the exhaust system of other appliances.
16. Ensure the bottom of the water heater is parallel to the horizontal surface while installing.
17. Park the vehicle onto flat ground while in use.

### What should I do if I smell the gas?



- Evacuate all personnel from vehicle.
- Shut off the gas supply at the gas container or source.
- Do not use any of the vehicle's electrical appliance or use any phone the vehicle.
- Do not start the vehicle's engine or generator.
- Contact the nearest authorized service provider or gas supplier for repairs.
- If you cannot contact an authorized service provider or gas supplier, contact the nearest fire department.
- Do not open the gas supply until the gas leaks has been repaired.

### Warnings:

- Stay away from water to prevent shock.
- **NEVER** use for indoor heating.
- **NEVER** use in mobile homes.
- **NEVER** use in food trucks or roadside food carts.
- **NEVER** use in construction trailers.
- **NEVER** heat pool water with this machine.

# Installation Instructions



- This product is not suitable for DIY installation.
- Installation and maintenance must be carried out by qualified person, service company or gas water heater suppliers.
- Improper installation, commissioning, modification or maintenance may lead to property damage, personnel injury or death.
- The product must be installed and repaired by our company or our authorized installation service company, otherwise our company will not be responsible for any accidents caused by improper installation or maintenance.

## Rv water heater installation check list:

- After receiving the RV tankless water heater, please check whether your gas supply is as required by the RV water heater, which is stated in the specifications.
- After opening the product box, please check whether any damages in the water heater body, and screw threads.
- Open the RV Water Heater's front door, and take out the Digital Controller which is put inside the chamber of the water heater, next to the exhaust vent.
- Check whether the exhaust vent is clogged or blocked, clean up if anything.
- Check whether the gas pressure meets the requirements stated in the specifications. Check whether the water pressure meets the requirements stated in the specifications.
- Check whether the power supply is 12V DC (Direct Current).
- Connect your 12V DC Power Supply to the white and black cables in the back per instruction: Black cable is positive, white cable is negative. Also connect the Digital Controller to the two Blue cables in the back, it's unnecessary to differentiate the positive and negative cables for the Digital Controller.
- Connect your cold water pipe to the water inlet, hot water pipe to the water outlet, and gas supply to the gas inlet per the labels on the back of the water heater.
- Check whether the gas pipe fittings are fully sealed, make sure there are no gas leaks. Check whether Washers/Teflon Tapes are correctly used in the water pipe fittings, and make sure there are no water leaks.
- Make sure to use the original Digital Controller that match with the water heater. otherwise EC errors will occur.
- For the first time using of the water heater, it is normal that it may take 2~3 times of turning the water heater on and off before igniting successfully, as the air residing in the gas pipes needs to be evacuated so that the gas pipes can then be filled with propane gas.

# Prepare for installation

## Parts included

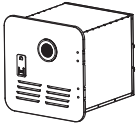

FOGATTI Tankless Water Heater



User's Manual

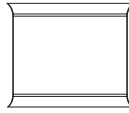

Assembly Kit



Wired Controller

## Tools needed



Screw Driver



Wrench



Scissor

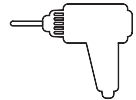

Hammer Drill with Concrete Bits



Pliers

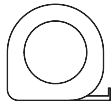

Ruler

## Materials needed

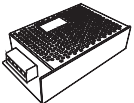

12V DC Power



Soapy Water

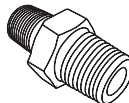

Pipe Fittings

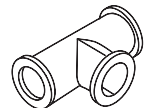

Threaded Tee Fitting  
(Middle 3/4" both ends 1/2")

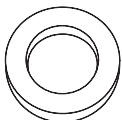

Washers



Pressure Relief Valve



Electrical Adhesive Tape

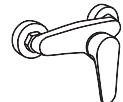

Thermostatic Mixing Valve



Gas Pressure Regulator

● Please keep any parts removed from this model inaccessible to children to avoid injury.



● **The installation must conform to one or more of the followings, as applicable.**

- 1) Local codes or, in the absence of local codes, the National Fuel Gas Code, **ANSI Z223.1/NFPA 54**, and/or **CSA B149.1**, Natural Gas and Propane Installation Code;
- 2) Local codes or, in the absence of local codes, Recreational Vehicles, **NFPA 1192**, and/or **CAN/CSA-Z240** RV Series;
- 3) Local codes or, in the absence of local codes, with the National Electrical Code, **ANSI/NFPA 70**, and/or the **CSA C22.1**, Canadian Electrical Code, Part 1 The appliance must be isolated from the gas supply piping system by closing its individual manual shut-off valve during any pressure testing of the gas supply piping system at test pressures equal to or less than  $\frac{1}{2}$  psi (3.5 kPa).

Provisions for adequate combustion and ventilation air in accordance with one of the followings:

- A) The national Fuel Gas Code, **ANSI Z223.1/NFPA 54**;
- B) **CSA B149.1**, Natural Gas and Propane Installation Code;
- C) Applicable provisions of the local building code.



**The following instructions are applicable to the FOGATTI RV gas water heater. If you have any query about a particular installation or application, please consult our company or authorized partners for installation and maintenance issue.**

- The water heater must be properly installed to ensure the air flow is free of obstruction at any time when the air inlet louvers and exhaust pipes are in place.
- During any stress test of the system, the device should be disconnected from the air supply piping system.
- Do not install this product under a hanging structure. It should be installed in a firm position.
- This product should be installed in any place where the door will not cover or block the flue gas exhaust pipe. If this condition is not allowed, please ensure a minimum of 6 inches gap between the water heater vent and the door when the door is opened.
- If the wall is not fire-proof, any gap between the back of the product and the surrounding flammable structure and combustible materials must be filled with heat-proof and flame resistance materials.
- The equipment should not be installed on a vinyl panel, due to the difference in the vinyl panel.
- Do not install the water heater venting pipe at a position less than **1ft (305mm)** from the door or window.
- Do not install the water heater or any other electrical appliances facing the gas exhaust pipe or in the zone covered with awning, canopy, or any other enclosure.
- The water heater can be installed in the trailer or under the retractable awning, but the awning must be well ventilated.
- The water heater must be installed upright, otherwise it will affect the normal operation of the water heater.
- When the water heater is installed, it should be reliably grounded.
- Clean the dirt in the pipe before the inlet pipe connecting to the outlet pipe.
- A suitable assembled filter should be installed at the back of the water pump for filtration, without which our company will not claim any warranty.
- Valve should be installed in gas pipe, inlet pipe and outlet pipe for easy maintenance and servicing.

- Check for gas and water leakage after installation, make sure the machine is safe to operate.
- The minimum distance from the smoke outlet to the flammable surface should be **>20 inches (500mm)**.
- The normal operation gas pressure range of the water heater is maximum inlet pressure cannot exceed **13" w.c.(3.3 kPa)** and the minimum pressure cannot be lower than **8" w.c.(1.99 kPa)**. The water heater will not operate normally when out of range.
- For Canada: 0~4500ft above sea level; For US: 0~5000ft above sea level. If it exceeds 5000ft, it shall comply with the requirements of Canadian installation regulations CSA B149.1 and American installation regulations ANSI Z223.1/NFPA54, and the input rate will decrease by 4% for every 1000ft increase in altitude.

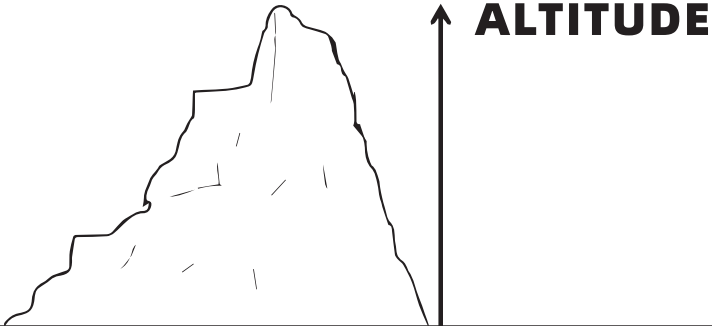

If a relief valve discharges periodically, this may be due to thermal expansion in a closed water supply system. **Contact the water supplier or local plumbing inspector to rectify the issue.** Do not plug the relief valve.

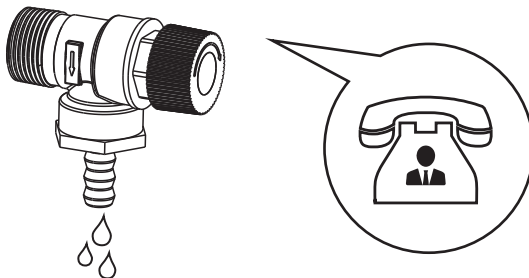

**▲ Sharp edges can cause cuts and injury!**

- Always wear protective gloves to avoid injuries from sharp edges during installation work and while handling the appliance.



## ● Pressure relief valve notices

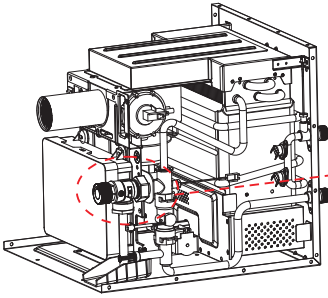

- If you have purchased our machine with not internal relief valve, you need to install Pressure valve on the outside.

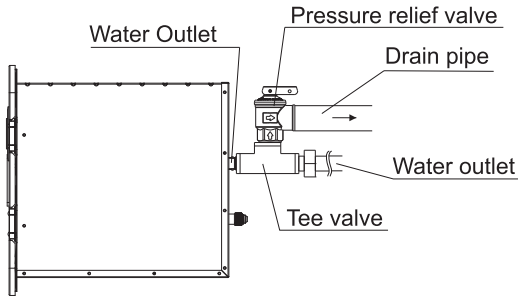

(Picture A)

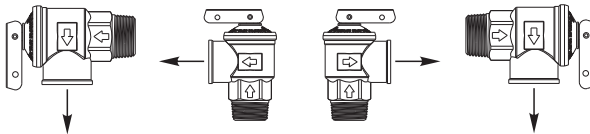

(Picture B)

Please use Teflon tape or sealant to seal the thread of pressure relief valve, then install it into Tee valve 3/4 " NPT outlet (see Picture A)

Please use Teflon tape or sealant to seal the thread of water outlet, then install pressure relief valve, tee valve and water outlet together. Please select a suitable position to install (see picture B). Please note that the outlet of pressure relief valve can not face upward, otherwise it will always leave some water inside.

- Anti-fouling and anti-scaling, dirt will directly affect the normal function of the safety valve function.
- The drain pipe must match the drain port to ensure that the valve does not interfere with the normal operation of the valve.
- The pressure relief valve outlet can be installed horizontally or vertically, but it cannot make pressure outlet facing upwards, otherwise it can not work normally. It is forbidden to block its outlet.





## WARNING

No valve is to be placed between the relief valve and water heater. The discharge from pressure relief valves shall be conducted to a suitable place and that no reducing coupling or other restrictive instruments to be installed in the discharge line. In addition, the discharge line installed is to allow complete drainage of both the valve and line.

Model	Recommended pressure relief value / temperature
FS06B1S,FS08B1S	100PSI/210°F

## ● Maintenance

- Dirt will directly affect the normal functioning of the safety valve. It requires hot water system maintenance of anti-fouling and anti-scaling cleaning.
- **The user must check the relief valve at least annually.** During checking, turn off the water heater's power and gas supply. Turn on the water inlet switch to create pressure in the water system. Then gently open relief valve handle until there is water flowing out and then gently close it. If no water flowing out, the valve is invalid. Immediately turn off the water heater switch and ask the service personnel to deal with it. Before operating the handle, check the discharge line connecting the valve to ensure that the water draining from the valve can be discharge to a suitable place.

①

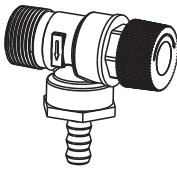

②

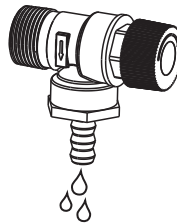

- Do not operate the relief valve when the water heater is in normal operation to avoid being scalded by hot water



WARNING



# Installation Steps

1. Select a suitable installation location on the RV before installation.

Do not install the water heater along the RV aisle. It shall be installed on the exterior wall of the RV with the exhaust pipe facing outwards from the RV. RV hot water heater shall be installed on a solid, non combustible floor (other than wood flooring) or on a non-combustible frame. If the surrounding of the opening is a combustible material, use a flame-retardant insulating material such as heat-insulating mat or heat-insulating board to completely segregate the back surface of the water heater from the combustible surface.

The minimum thickness of the filling material must be greater than 0.8"(20mm). The housing connection gap behind the water heater should be sealed with a high temperature sealant during installation to isolate it from the inside of the RV. In this way, the burning air does not come from the inside of the RV, but from the outside of the RV. The exhaust gas generated by the combustion is discharged out of the vehicle. **Cut a hole size of 13"x 13"(330x330mm330x330mm)**. The opening depth should be sufficient to accommodate the gas pipe, wire, and water pipe when the water heater is pulled out of the hole.

At the bottom or back of the hole, reserve entry space for the gas pipe, water inlet and outlet pipe, power line and other control lines. Sufficient space around the opening perimeter is recommended, usually 1.5 times for easy maintenance and testing(please refer to Picture 1).

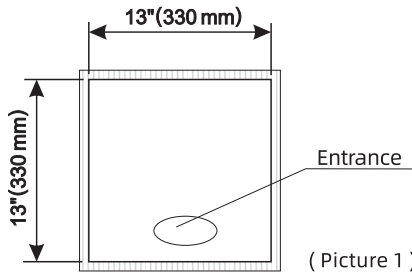

2. Both cold water inlet and hot water outlet are 1/2" NPT , a 100 PSI pressure relief valve is needed (relief valve is not included and sold separately) for the hot water outlet. Next, connect your propane gas supply to the 5/8" UNF gas inlet, and make sure to remove the black protective plug from the tip of gas inlet before connecting to your propane gas supply. Then, connect 12V DC power supply to the black and white cables, the black cable is positive, and the white cable is negative. Lastly, connect the remote controller with the two blue cables; no need to differentiate the positive or negative poles in this case.

**Note:** Please make sure to leave enough extra length of the pipes and cables as a buffer, so that you can easily pull out the water heater without damaging the connected pipes and cables.

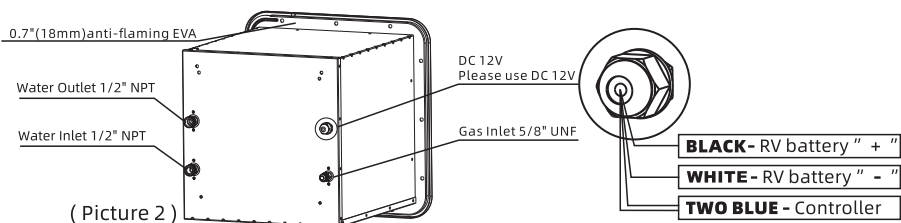

( Picture 2 )



**WARNING**

This water heater is designed for RV users. The operating voltage is DC 12V , and the gas source is propane.

Excessive force will damage the water heater's cold water and hot water connections. When installing the gas joint, tighten the joint with two wrenches to avoid damaging the connection joint.

3.The water heater flange cover is pasted with 0.7"(18mm) wide single-sided adhesive EVA. The flame retardant material shall be flat and connected seamlessly. (Be careful not to be too thick) **Press this product into the opened hole. Secure the water heater to the car body with 12 screws (ST5x25mm)** Air and water should be isolated from the openings to prevent entry into the interior of the RV. (Please refer to Picture 3)

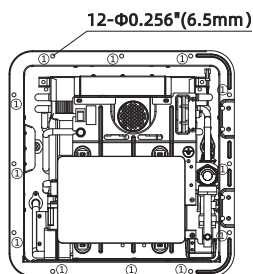

( Picture 3 )

4.Choose a convenient location to place the wired controller. The connection between the wire controller and the water heater should be reasonably laid out according to the specific environment. **Fix the bottom controller holder with the two ST4x16 screws provided and place the controller into the holder** (Please refer to Picture 4).

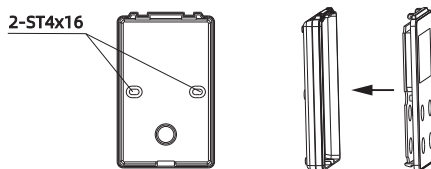

( Picture 4 )

● After fixing the screws, please use the insulation strip inside the installation kit to wrap the screw head in case of damaging the wire controller which can cause a short circuit.

# Operation Instructions

The user shall confirm whether the water heater is installed correctly before the initial use, carefully check that the connections are properly connected and leak free. After verifying, please follow the below steps:

## To start the device

1. Confirm that the power switch to the water heater is turned on;

2. After confirming the power is on, press key " ⏻ " on the wire controller;

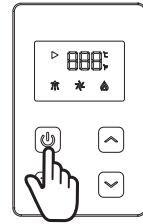
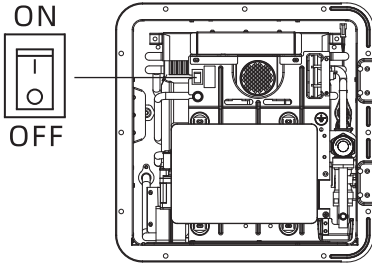

3. Turn on the water inlet valve and gas valve;

4. Turn on the water outlet valve (hot water tap), once the water heater is initiated, hot water will flow out.

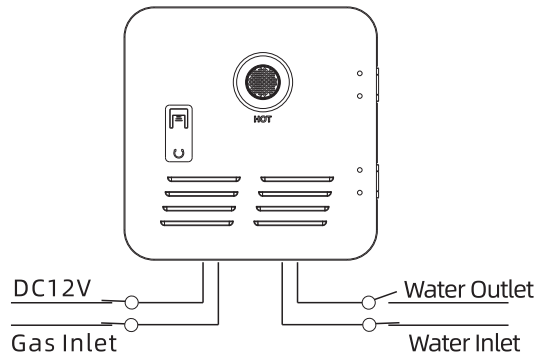

● Minors are not recommended to use the machine alone unless with adults accompany.

## ● Wired Controller Instructions:

- 1.The controller emits a buzzer sound "Beep" when the power is turned on. The display shows the gas source code, and this code will remain for 3 seconds before going off. The controller's indicator light is on and the back light of the power switch button is lighted.
- 2.After pressing the power button, the fan, shower, flame and water temperatures are displayed in real time according to the operating status
- 3.Set the temperature to the temperature you required, the set temperature will flash for 5 times, then it will automatically switch to display the current water temperature
- 4.Press "°F/°C" to switch between Celsius and Fahrenheit (degree).
- 5.In the event of a fault alarm, the display will show the error code;
- 6.The buzzer sound "Beep" occurs when the system is powered on or is operating effectively. When fault occurs in the system, the buzzer sound "Beep, Beep, Beep" is sounded continuously for 10 times, with an interval of one second between each sound.
- 7.After using the water heater, please press "⏻" to turn off the heater (water and gas supply should be turned off at the same time).

## ● Steps to Setting Water Temperature:

- 1.The setting range of the outlet water temperature of this machine is 95°F-123°F (35°C - 51°C); Outlet water temperature is designed not to exceed 123°F (51°C).
  - 2.Each time you press the "▲" key, the temperature will increase by 1 °C. See following Fahrenheit and Celsius comparison table for reference.
  - 3.Each time you press the "▼" key, the temperature will increase by 1 °C. See following Fahrenheit and Celsius comparison table for reference.
- Celcius Degree and Fahrenheit Degree Comparison (Please refer to Table 1)

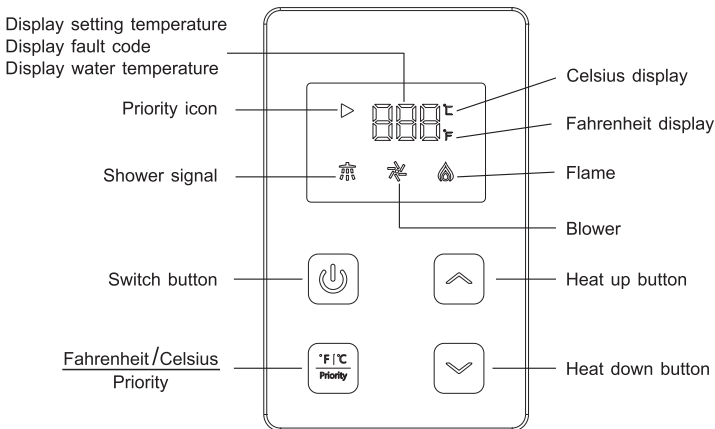

95°F (35°C)
96°F (36°C)
98°F (37°C)
100°F (38°C)
102°F (39°C)
104°F (40°C)
105°F (41°C)
107°F (42°C)
109°F (43°C)
111°F (44°C)
113°F (45°C)
114°F (46°C)
116°F (47°C)
118°F (48°C)
120°F (49°C)
122°F (50°C)
123°F (51°C)

( Table 1 )



### FOR YOUR SAFETY

Do not store or use gasoline or other flammable vapors and liquids in the vicinity of this and any other appliance.

# Fault Assessment and Troubleshooting

Fault handling: When the water heater fails, the display panel will show the error code, and the buzzer will sound the alarm "Beep, Beep, Beep" continuously for 10 times. Please follow the table below for the corresponding troubleshooting.

Error Code	Fault description and troubleshooting step
E0	The outlet temperature probe is open or shorted. Please check or change the outlet temperature probe connection.
E1	Ignition failure, no ignition or accidental flameout during operation. Please check whether the gas is supplied normally and continue using when it has been checked to be normal.
E2	Before ignition, a flame signal was detected, and the beeping alarm prompted a failure. Clear the fault after power failure is necessary.
E3	The thermostat malfunctions, and the temperature control is detected to fail during operation or start up of the water heater. Check the temperature controller connection or could have been due to over temperature of the water.
E4	The inlet temperature probe is faulty or the inlet temperature probe is open or shorted. Please check or change the outlet temperature probe connection.
E5	Fan failure, no fan signal detected during start-up or water heater operation.
E6	Over-heating failure. The display will show error code when the water temperature maintains above 176°F (80°C) for more than 3 seconds. Please check whether the water supply pressure is too low.
E7	Before normal combustion, the main valve opens or shorts; the proportional valve opens. During normal combustion, the main valve opens or shorts; the proportional valve opens.
E8	Wind pressure switch failure, when the power is turned on for 5 seconds, the wind pressure switch closes or the wind pressure is continuously disconnected for 2 seconds.
E9	Pseudo-fire fault, when the start-up ignition detected a flame signal, buzzer alarm.
En	Water heater set timer timeout ("En" is set to open).

## Fault alarm release and reset method.

If the above code appears, please check whether water or gas is normal, press the on/off switch on the remote controller to power off or to restart the gas heater. (When the on/off button is pressed 5 times within 15 seconds, the machine will lock down automatically, even with no error code. You can either wait for 15 minutes or restart the machine by the switch or controller for immediate restart.) If after executing the above operations and it still cannot return to normal use, please inform the after-sales service personnel.

● **Non-defect when the following conditions occur:**

<b>Phenomenon</b>	<b>Reason and handling method</b>
White smoke at exhaust	When the outdoor temperature is too low, the exhausted smoke encounters outdoor cold air and condenses into a white mist.
Hot water flow is too slow or turn into cold water	If the hot water is too little to ignite the water heater, the water will become cold. A minimum water flow of 1 gallon per minute is required to ensure the stable operation of the water heater.
Failure to provide hot water during winter	The water temperature is too low, the water flow exceeds the heating capacity of the water heater. Please adjust the amount of water appropriately.
After 20 minutes or 40 minutes, the water heater suddenly goes out	To prevent oxygen deprivation, some models have 20 or 40-minute timing protection. Please turn off the tap and use it after a while.
After closing the hot water valve, the fan did not stop immediately	The function of delaying the shutdown of the fan is to completely discharge the exhaust gas of the water heater to ensure the safety of the user.
After opening, hot water does not come immediately	On the one hand, the time lag between the hot water valve and machine body may be the reason. On the other hand, the existed cold water within pipeline takes time to be showered out, the longer the pipeline, the longer time it takes.
After the machine is powered on, the remote controller does not respond	Open the door of the water heater door and make sure the switch inside the door is open and the fuse is intact. If the fuse blows, replace with fuse of the same size. (Fuse: 10A 125V)

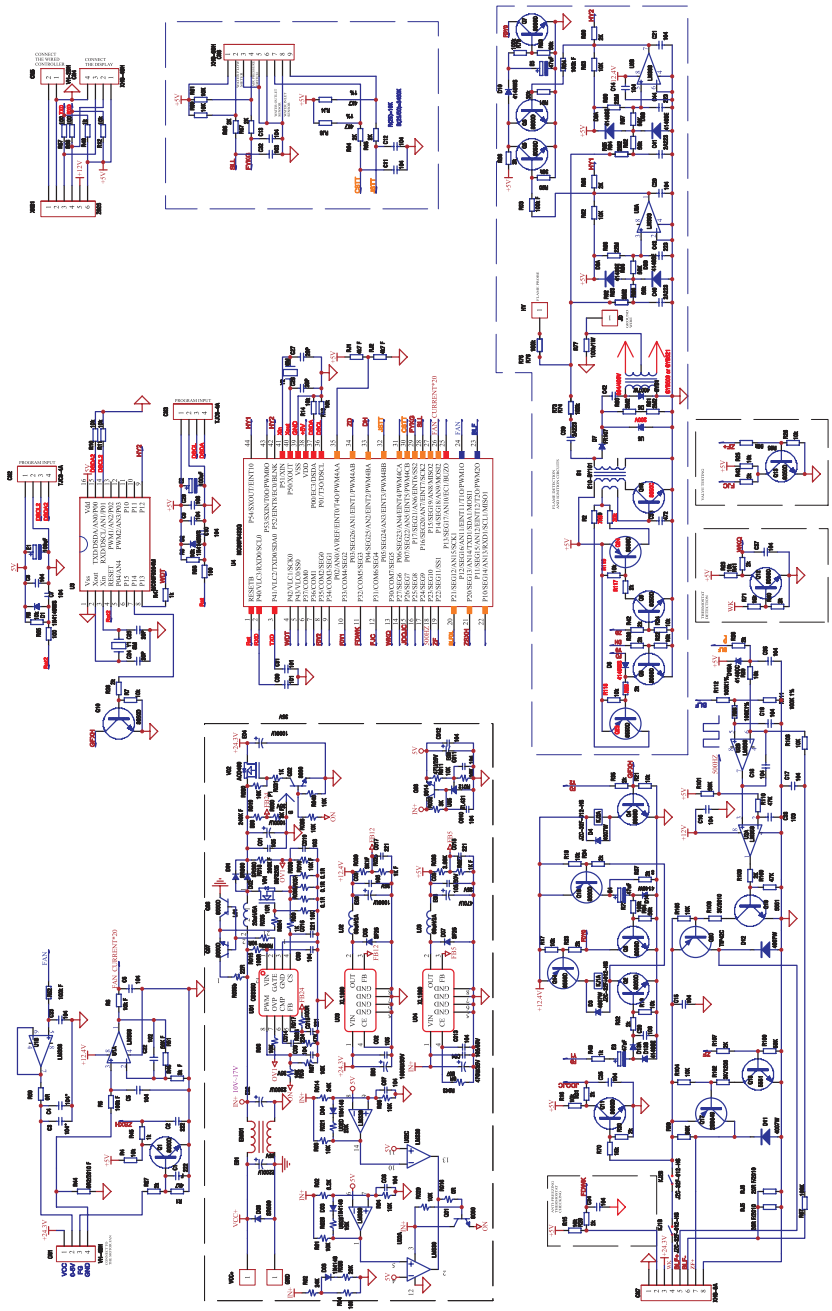



# Product Wiring Diagram



## WARNING

- Label all wires prior to disconnection when servicing controls. Wiring errors can cause improper and dangerous operation.
- Verify proper operation after servicing.

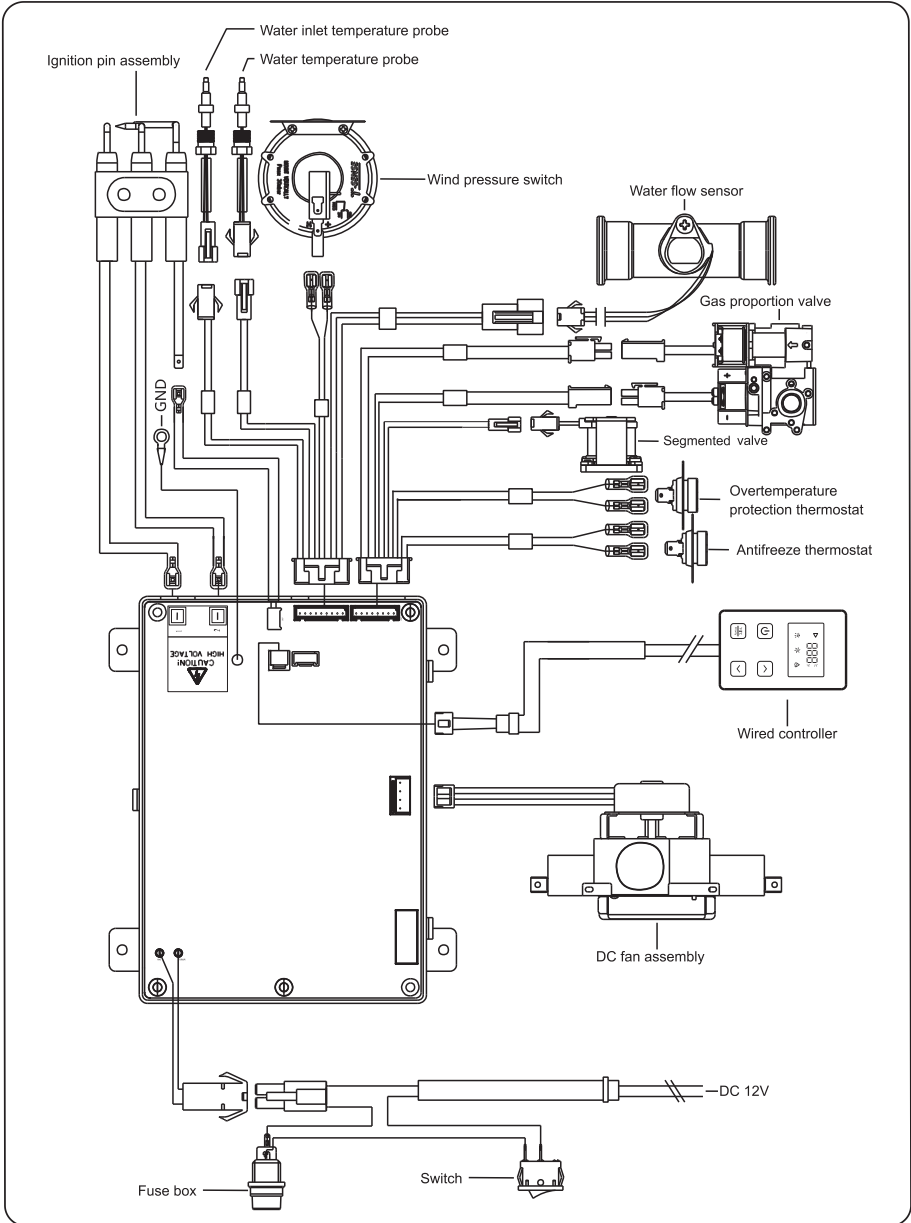

# Maintenance

For your comfort and safety, we recommend checking and maintaining the product monthly. Disconnect the power supply and allow the unit to cool down before performing maintenance. Do not disassemble gas passages and safety device during maintenance. As the unit has some electronic components inside, do not open it to avoid contact with any type of liquid.

## ● Routine inspection:

1. Check the air intake grille, exhaust vent for dust, avoid obstruction.
2. Check the unit for unusual appearance.
3. Check the unit for abnormal noise during operation.
4. Check for water and gas leakage.
5. Check whether the flame is burning normally every month. The flame should appear blue color through the observation window and the combustion is stable. No jitter, no lifted flame, no back draft, etc. If anything abnormal, please contact the service provider to repair
6. When carbon deposits are found, they should be promptly notified to the after-sales service provider for maintenance. The serviceman will remove the burner with the crater facing down, use a bristled brush to remove the carbon deposit, or replace the burner with a new one.

## ● Maintenance Instruction:

1. Clean the unit regularly. Do not use chemical lotion and volatile solvents to avoid discoloring of the outer shell.
2. Clean the air intake grille, dust filter and exhaust port regularly for better performance, Not obstructing the flow of combustion and ventilation air. Open the panel, Clean with water.
3. Turn off the water inlet, remove water inlet pipe, clean the filter, and reinstall.
4. Drain water from the RV regularly and flush the heat exchanger with an approved detergent. (Please refer to the RV vendor's instructions)
5. Wipe the display with a damp cloth. Do not use gasoline or grease detergents to avoid shape changes.

● Keep the appliance area clean and free from combustible materials, gasoline, and other flammable vapors and liquids.









● Pay attention to the preset temperature. Skin burn may occur when preset temp. is too high.

● Should overheating occur or the gas supply fails to shut off, turn off the manual gas control valve to the appliance.

● Caution: Label all wires prior to disconnection when servicing controls. Wiring errors can cause improper and dangerous operation. Check for proper operation after servicing.

## Setting minimum heat load:





### Method#1



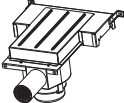
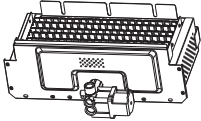
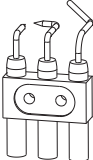
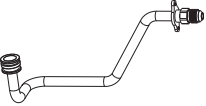
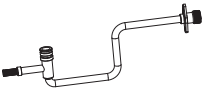
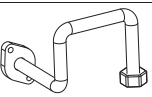

1. Plug in electricity, it will show "0-9" number program code.
2. Press  for 3 seconds, it will show "PP"
3. Press  to show FA; Press  to show specifications: set the value to be 00. Press  to exit.
4. Press  to show PH; Press  to show PL. Then turn on the gas and water. The water heater will run at minimum heat load.
5. After testing above, press  to switch specifications like PL, dH, FH, FL ..... till it shows "qu", then press  to save and exit setting.

### Method#2

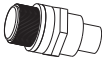
Set the temperature on remote controller to be 95°F (35°C), if the water inlet temperature is high enough to make outlet water temperature higher than 95°F (35°C), it proves that the water heater is running at minimum heat load.

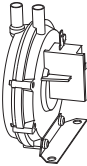
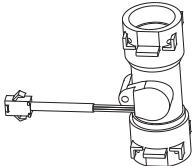
# Replacement parts: components

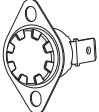
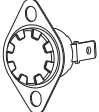
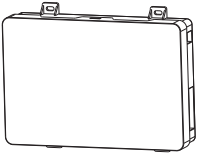
Parts	Photo
Lock	
Gas control valve	
Draught fan assembly	
Burner	
Ignition pin assembly	
Gas inlet assembly	
Water inlet assembly	
The connection pipe of burner and valve	
Wired controller	
FUSE(125V 10A)	

Parts	Photo
Wind pressure switch	
Water flow sensor	
Water Inlet temperature probe	
Water Outlet temperature probe	
Overtemperature protection thermostat	
Antifreeze thermostat	
Burner controller	
Water inlet filter	

## Drainage and Storage Instruction

If the RV is to be stored during winter, water must be drained from the gas water heater to prevent freezing damaged water heaters. Please follow the steps below:

1. Close the cold water inlet valve of the water heater. Open the hot water faucet or shower connected to the hot water outlet to connect the water pipeline of the water heater to the atmosphere;

2. Remove the drain screw as shown in the figure, and the water in the water heater will drain ;(see the figure below)

3. After the water in the water heater is drained, install the drain screw.

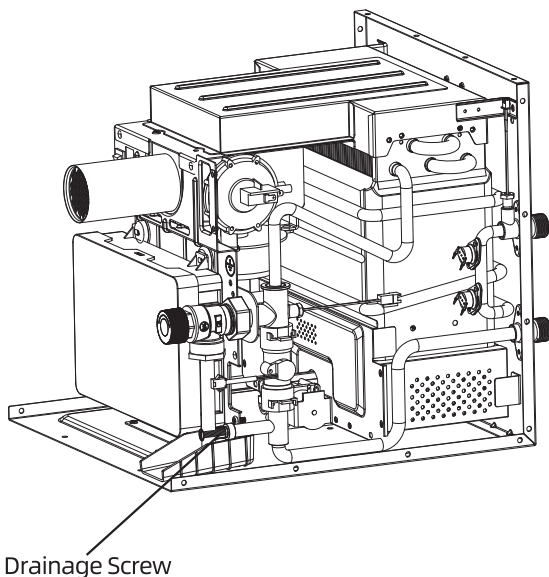



## Antifreeze System

Water heaters must be protected before travel to a potential freezing environment. Frost damage is not covered by the warranty. The anti-freezing function operation method is:

1. Draining water from the water heater. Applicable when the unit is not in use for long period. (For specific operations, see "Drainage and Storage Instructions")
  2. Add antifreeze recommended by the RV manufacturer.
  3. Start the antifreeze function to prevent freezing. Turn on the power switch and the gas valve, turn off the water inlet. The water heater will be on antifreeze mode automatically (please ensure enough gas in the RV).
- When the water temperature in the water heater is lower than  $43^{\circ}\text{F} \pm 2^{\circ}\text{F}$  ( $6 \pm 1^{\circ}\text{C}$ ), the remote controller displays "FD", the machine starts the ignition and runs with a certain load. After the whole machine operates for 5 seconds or when the temperature of the water pipe reaches  $90^{\circ}\text{F} \pm 2^{\circ}\text{F}$  ( $32 \pm 1^{\circ}\text{C}$ ) in 2 seconds, the water heater will automatically shut off. After shutting down for 3 minutes, the water heater will check whether the temperature is lower than  $43^{\circ}\text{F} \pm 2^{\circ}\text{F}$  ( $6 \pm 1^{\circ}\text{C}$ ) or when the antifreeze thermostat contact closes to run the heater and this cycle continues.
  - In the process of starting the antifreeze function, if a fault occurs, the corresponding fault is reported and the code is displayed. After 15 minutes, the system automatically clears the fault code. If the freeze protection start condition is still met, the antifreeze will start again.

## Antifreeze Tips

● When the temperature is below 44.6°F(7°C) while above 32°F(0°C), keep your water heater staying plugged in a 12V DC power supply and supplied with liquid propane gas, the anti-freeze system automatically ignites and heats up to create an inner cycle of hot water, and prevents the water heater from damages. No manual work is needed.

● If the machine is not used for a long time, or if the ambient temperature is below 32 °F (0 °C) and the machine cannot be kept powered with electricity and gas, it is necessary to drain the water from the water heater to prevent damage due to freezing. And here is the process:

- 1) Turn off the LPG (liquid propane gas) shut-off valve.
- 2) Power off the RV tankless water heater and unplug the power supply to the machine.
- 3) Turn off the water supply shut-off valve.
- 4) Turn on hot water taps in the RV or camper, to release the water and pressure in the pipes.
- 5) Screw out the drain screw (inside the machine) to drain the water; use a bucket to collect the residual water while draining.
- 6) It may take more than 10 minutes to drain out the water. Please make sure that water is fully drained from the machine.
- 7) Securely screw the drain screw back in place and turn off hot water taps and hot water outlet valve.
- 8) Before you use the RV tankless water heater next time, plug it back in the 12V DC power supply, power on the machine, and then turn on the water supply shut-off valve, the hot water outlet valve, and the LPG (liquid propane gas) valve.

● **Please kindly note damages caused by freezing are NOT covered under the RV tankless water heater warranty as the industry standard. Please kindly make sure to take all the measures to protect your RV tankless water heater.**

# Model and Specification

Product name		Instant Gas Water Heaters for RV	
Model		FS06B1S	FS08B1S
Control instruction		Manually set the water temperature, can be set between 95°F(35°C) and 123°F(51°C)	
Max. /Nominal Heat Input (Btu/hr)		42,000	55,000
Minimum Heat Input (Btu/hr)		8,500	
Orifice Drill Size		0.91mm for LPG	
Max. Inlet Gas Pressure		13 "WC (3.23 kPa)	
Min. Inlet Gas Pressure		8 "WC (1.99 kPa)	
Max. Manifold Pressure		3.53" WC(0.88 kPa)	5.46" WC(1.36 kPa)
Min. Manifold Pressure		0.56" WC(0.14 kPa)	
Total Input Current		< 10A	
Rated Gas Inlet Pressure		LPG 11" WC (2.74 kPa)	
Ignition method		Automatic ignition	
Connector Specification	Applicable water pressure	14.5-116PSI	
	Gas inlet	5/8" UNF	
	Cold water inlet	1/2" NPT	
	Hot water outlet	1/2" NPT	
Electric supply		DC 12V	
Rated power		41W	46W
Dimension		15" x 15" x14.3" (380mm x 380mm x 365mm)	
Max. Temperature		123°F(51°C)	

———— We reserve the right to amend the product without prior notice. ————



# Packing List

Order	Design	Quantity	Remarks
1	Gas water heater	1 piece	
2	Instruction Manual (including warranty card)	1 piece	
3	Controller	1 piece	
4	Screw	12 pieces	ST5x25
5	Screw	2 pieces	ST4x16
6	Insulation strip	1 piece	

# Warranty Card

User name		Serial number
Product name		
Product model		
Purchasing date		

Warning! For your safety, please ensure that your installation conditions meet the following requirements: (applies only to water heater products)

- The power supply of the water heater must be reliably grounded and equipped with a leakage protection device to prevent accidental circuit leakage.
- Power outlet, connector may be spilled into the water. Use a splash-proof power outlet and take care of the watertight joints.
- Water heaters should be used on the RV. Do not use indoors. Exhaust gas is discharged outside the vehicle to prevent carbon monoxide poisoning.
- Gas pipelines, the waterway must be reliably installed without leakage. Prevent damage due to leakage.
- The installation of the water heater should comply with local laws and regulations.



