

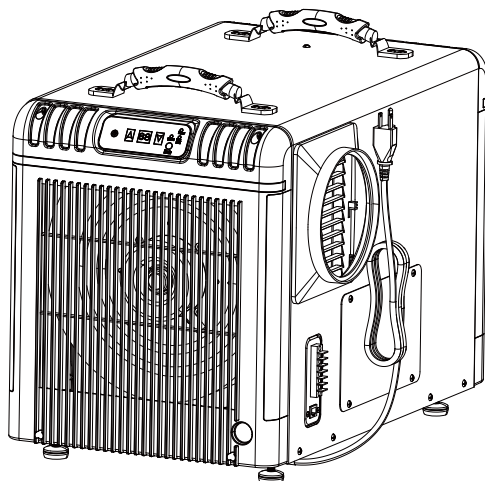

## Sentinel HDi90

### Installation and Operations Manual



## AlorAir Solutions INC.

Add: 14752 Yorba Ct Chino CA 91710 US

Tel: 1-888-990-7469

E-mail: [sales@alorair.com](mailto:sales@alorair.com)

Specifications subject to change without notice.

# Table of Contents

Warranty Registration	2
Safety Notes	2
Identification	3
Electrical Supply	3
Principle of Operation	3
<b>Installation</b>	<b>3</b>
Key Functions	4
Indicator Lights	5
Remote Control	6
Operating Instructions	6
Diagram	7
Maintenance	8
Dehumidifier Storage	9
Ducted Applications	9
Troubleshooting	11
Spare Parts	12
Warranty Information	13

# Warranty Registration

Congratulations on purchasing a new Sentinel Dehumidifier. Your new dehumidifier comes with an extensive warranty plan. To register, simply fill out and return the warranty form provided in your dehumidifier box.

Be sure to note your dehumidifier serial number as you will need it for registration.

## Safety Notes

- The Sentinel Series Dehumidifier must always be connected using a grounded electrical connection (as required for all electrical appliances). If non-grounded wiring is used, all liability reverts to owner and the warranty is voided.
- Sentinel Dehumidifiers should only be maintained and repaired by a qualified technician.
- Sentinel Dehumidifiers are only intended for operation when oriented with the unit sitting on its feet and level. Operating the unit in any other orientation could allow water to flood electrical components.
- Always unplug the dehumidifier before moving it to another location.
- If there is a chance that water flooded the dehumidifier, it should be opened and allowed to dry thoroughly before reconnecting to electrical power and restarting.
- To ensure proper operation, neither the inlet nor discharge should be positioned against a wall. The inlet requires a minimum of 6' clearance and the discharge requires a minimum of 6' clearance.
- Do not insert your fingers or any objects into the inlet or discharge.
- All work on the dehumidifier should be done with the unit "off" and unplugged.
- Do not use water to clean the exterior. To clean unit, unplug from power, then use a damp cloth to wipe the exterior.
- Do not stand on machine or use it as a device to hang clothes.

# Identification

For future reference, write down the model, serial number, and date of purchase for your dehumidifier. This is extremely helpful if you need to seek assistance in the future. The data label on the side of your unit has the key characteristics of your specific unit.

**Model Number:** Sentinel HDi90

**Serial Number:** \_\_\_\_\_ **Date of Purchase:** \_\_\_\_\_

For additional questions concerning your dehumidifier, the following options are available:

- Contact your installing contractor
- E-mail:sales@alorair.com

# Electrical Supply

Power Supply: 115 V, 60 Hz AC, Single Phase

Outlet Requirement: 3-Prong, GFCI

Circuit Protector: 15 Amp

**WARNING:** 240 Volts AC may cause serious injury from electric shock.

To reduce risk of injury:

1. Disconnect electrical power before servicing .
2. Only plug unit into grounded electrical circuit .
3. Do not use an extension cord .
4. Do not use a plug adapter .

# Principle of Operation

The Sentinel Series Dehumidifiers utilizes its integral humidistat to monitor the conditioned space. When the relative humidity goes above the selected set point, the dehumidifier will energize. Air is drawn across an evaporator coil, which is cooler than the dew point of air. This means moisture will condense out of the air. The air is then reheated through the condenser coil and distributed back into the room.

# Installation

The area to be controlled should be sealed with a vapor barrier. If unit is installed in a crawlspace, all vents should be sealed.

**WARNING:** Do not install your dehumidifier in a corrosive environment. Some liquid vapor barriers dry via “solvent evaporation”. Always make sure that barrier is completely dry and area is thoroughly ventilated before installing dehumidifier.

**Step #1: Place dehumidifier on a level surface.**

Do not place unit directly on vapor barrier. For example , use blocks or pavers to create a level surface.

If the unit is handled in such a manner that the compressor did not remain in the upright position, you will need to place it on a level surface, then wait a minimum of 2 hours before turning "on".

## Step #2: Set Up Drain Line

The included drain line attaches to unit via a compression type fitting on the discharge end of the unit. To attach drain line, remove the compression nut and slide it over the end of the hose to be attached to unit. Slide compression nut side of hose over the insert on the compression fitting completely. Tighten compression nut.

## Step #3: Plug unit into 15 amp grounded circuit.

# Key Functions

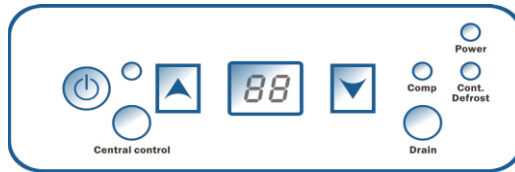

### 1. Power Key

- Use this button to turn the dehumidifier on and off. Press once to turn the machine on. You will hear 1 beep and the  light will illuminate green. Press the power button a second time and you will hear one beep as the machine shuts down. Note that there is a one minute fan delay on shutdown.

### 2. Arrow Buttons

- Use the up and down arrow buttons to set the desired humidity setpoint on the display screen.

 88

The setpoint can be any number between 36-90%. Creating a setpoint means that when the indoor humidity is lower than the set point, the machine will stop automatically. Conversely, when the indoor humidity is higher than the set level, the unit will operate. NOTE: The humidity levels displayed are approximate only (+/- 5%).

### 3. Continuous Mode

- To switch into continuous mode, simply use the down arrow key to set the humidity below 36%. At this point the Cont. light should illuminate green on the display board to indicate you have successfully switched to continuous mode. The display screen will show "CO".
- When set to continuous, the dehumidifier will run constantly, regardless of the humidity level until you turn the unit off or switch back to normal humidistat operation. If you would like to switch back to normal humidistat operation, simply move the setpoint above 36%.

### 4. Central Control

- This mode is not applicable on the Sentinel HDi90.
- Central Control light should off at all times when not connected to the AC.

## 5. Manual Drain Button

- For extended storage or movement of the machine, press the “Drain” button to remove water from the integral pump’s reservoir.

## 6. Pump Trouble Warning

- When the pump reservoir water level is too high, the high water sensor will activate to prevent overflow. When this occurs, the dehumidifier will stop the compressor automatically and the display will show “E4”. After a 1 minute delay, the fan motor will turn off and the machine will not operate until the problem is resolved. To reset the unit after an “E4” error, check the pump to verify it is functioning, then unplug the unit for two minutes.

## 7. Auxillary Terminals A5/A6

- The A5/A6 on the terminal strip can be used as a water level warning switch for external condensate pumps.  
If an external pump is connected, the pump must have a self-contained power supply and a water level signal line.

# Indicator Lights

## 1. Humidity Display Screen

- The display screen has two functions:
  1. When the unit is powered on, it shows the humidity of the space.
  2. While setting the desired humidity level, the screen will show the set humidity. After a brief delay, the display will revert to current humidity level.

## 2. Power Indicator Light

- This light indicates that the unit is properly powered on and ready to operate. Always make sure the unit is “off” prior to performing any service.  
When the power light is blinking, it means that the unit has reached the humidity setpoint.

## 3. Continuous Mode/Auto Defrost Light

- When this light illuminates green, it indicates that the dehumidifier is set to continuous operation mode.
- When the light glows red, it means the unit is in auto defrost mode and clearing the evaporator coil of any ice buildup.

## 4. Compressor Light

- When the compressor light glows red, it indicates the compressor has been initiated but is currently warming up.
- Once the compressor light switches to green, it indicates the compressor is in working status.

# Remote Control Instructions

Sentinel Dehumidifiers can be controlled using an optional remote accessory. The Sentinel Remote Control connects to your Sentinel Series Dehumidifier via a 25' CAT 5 cable. The Remote control contains an integrated sensor which gives you multiple options for remotely controlling your unit, in addition to monitoring the conditions surrounding the dehumidifier.

One application for the remote control is to install the dehumidifier in one room with the conditioned air ducted into a second room that contains the remote. For example, the dehumidifier could be installed in a laundry room and ducted into a living room. The remote would then be mounted in the living room so the remote sensor can control the humidity and provide easy controls for the user.

Another useful application for the remote control is if the dehumidifier is in area that's difficult to access on a regular basis. For instance, if your dehumidifier is installed in your crawl space, the remote could be mounted in your living space or garage. This provides you with an easy way to monitor the dehumidifier.

## 1. On/Off (Power) Button



Press the on/off button and the machine will start running (one beep). Press the button again to turn the machine off.

## 2. Up Button ▲ / Down Button ▼

Use the Up and Down arrow buttons to adjust the humidity level.

## 3. Mode M

Use the Mode button to switch between dehumidification and a ducted application.

- The  symbol on the display board indicates the sensor on the remote control is being utilized.
- The  symbol on the display board indicates the sensor on the dehumidifier is being utilized

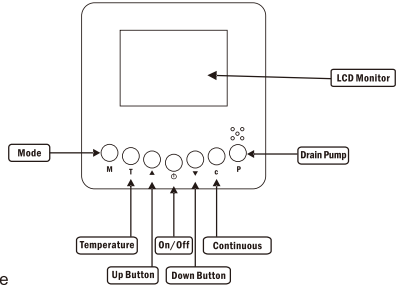

## 4. Temperature T

Press the temperature button to display the current temperature on the screen. Press the button again to turn off the display.

## 5. Continuous C

Press this button to switch the unit into continuous mode. **Cont.** will appear on the display to indicate continuous mode.

## 6. Drain Pump P

Use this button if the unit will not be in use for an extended period of time. Pressing the drain pump button will remove water from the pump reservoir, so the unit can be safely moved or stored.

*NOTE: The symbols mentioned above will only appear when the dehumidifier is powered on.*

# Operating Instructions

## 1. Start the machine

Press the power key to turn the machine on.

## 2. Adjust Settings

Use the up and down arrow keys to adjust your desired setpoint (typically 50-55%).

### 3. Stop the machine

Press the power key again and the machine will stop. Note the fan will continue to operate for 1 minute after the unit has shut off. NOTE: Do not disconnect power cord to force machine to stop. Always use power button.

### 4. Water Drainage

The Sentinel HDi90 has both automatic and manual draining. During normal operation, the Sentinel HDi90 will automatically drain as required. If you would like to store or move the machine, you may press the drain button to drain the water from the pump reservoir. The drain will operate for 28 seconds each time the button is pushed. It may be necessary to push the drain button more than once to completely empty the reservoir

## Sentinel HDi90 Diagram

### Front View

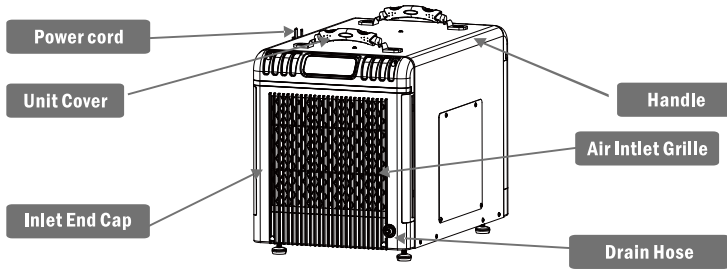

### Back View

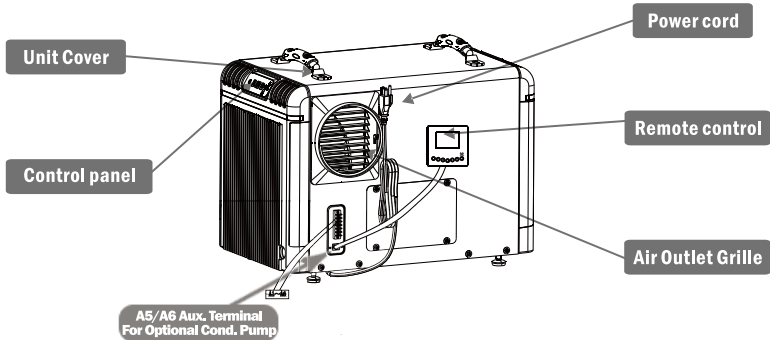

(not applicable for HDi90 model)



# Maintenance

**WARNING:** Always unplug the unit before doing any maintenance.

## Condensate Pump

Your Sentinel HDi90 is equipped with an integral condensate pump designed to pump water from your dehumidifier out to the desired drain. This pump requires routine maintenance that is not covered by your 1 year parts warranty. Only a defective pump will be repaired or replaced during the warranty period.

### Preventative Maintenance

As with all pumps, preventative maintenance is necessary to prevent issues from dirt and slime that may accumulate in the drain system. This includes the drain pan, hose to the condensate pump, pump reservoir, pump head float assembly, and discharge tubing.

### At least once per year, clean your pump system

#### ☑ Cleaning the machine body

Use a soft damp cloth to clean exterior of unit. Do not use any soap or solvents.

#### ☑ Cleaning the filter

1. Slide out the filter.
2. Clean the filter mesh by vacuuming or washing with warm water (no soap or solvents).
3. Be sure the filter is completely dry before restarting the unit.

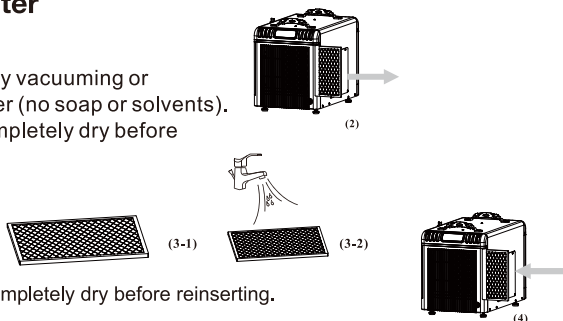

4. Be sure the filter is completely dry before reinserting.

#### ☑ Coil Maintenance

- Once per year, clean the coils with an approved coil cleaner. The coil cleaner should be a self-rinsing, foaming cleaner such as WEB® Coil Cleaner.

#### ☑ Electrical Access

1. Unscrew the 4 screws on the side panel to access the control board.

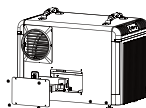

#### ☑ Pump maintenance

1. Unscrew the 4 screws on the pump access panel.
2. Remove the screw on the pump.
3. Undo the 3 pump quick connects.
4. Insert a flathead screwdriver into the notch on the side of the pump to help you gently lift the pump off its reservoir (the reservoir remains attached to the unit).

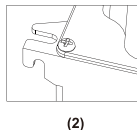
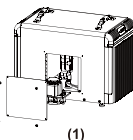

## Cleaning/Disinfecting the Pump

Basic Cleaning (Complete about once a year, depending on environment)

1. Open the end cap on the filter side of the unit. Press the drain button to drain the reservoir.
2. Disconnect power to the dehumidifier.
3. Mix a 16 oz solution of either (1 oz bleach + 15 oz water) OR (4 oz white vinegar + 12 oz water).
4. Pour solution into the drain tray at the base of the coils. If any cleaning solutions gets on coils, flush with water.
5. Allow solution to soak for 15 minutes.
6. Reconnect the dehumidifier to power.
7. Fill the reservoir with water and flush/cycle the pump at least two times.
8. If drain line is still filled with debris, repeat process. If still not cleaned, move on to Advanced Cleaning.
9. Reassemble unit, unless moving on to advanced cleaning.

Advanced Cleaning(Complete as needed)

1. Press the drain button to drain the water from the reservoir (A wet-dry vacuum or towels can be used to remove any remaining water).
2. Unplug the the dehumidifier and remove the cover so you have access to the pump.
3. Remove the pump head from the reservoir by unscrewing the screw. Wipe reservoir clean with a paper towel.
4. Mix a 16 oz solution of either (1 oz bleach + 15 oz water) OR (4 oz white vinegar+ 12 oz water).
5. Fill the pump reservoir with cleaning solution.
6. Reassemble pump, then use manual drain button to flush mixture through discharge tubing.
7. Pour same cleaning solution slowly into drain tray under evaporator coils and let it clean hose from pan to pump. This process can be stopped when the pump energizes one time. NOTE: If you get any of the cleaning solution on the coils, flush with water.
8. Pour sufficient clean water through drain pan to allow the pump to turn on twice.
9. Reassemble the unit and return it to operational status.

## Dehumidifier Storage

If the unit will be stored for an extended period of time, complete the following steps:

1. Turn off the unit and allow to dry
2. Complete steps #1-3 in Advanced Cleaning (above) to clean out pump reservoir.
3. Wrap and secure the power cord
4. Cover filter mesh
5. Store in clean, dry space

## Ducted Applications

Ducting the dehumidifier allows the unit to be in one room while conditioning an adjacent room. The inlet/return grille is designed for 12" flex ducting (optional accessory PN: W-103) while the supply grille is designed for 6" flex ducting.

Be sure to secure the ducting with tie wrap. Also, keep in mind, that the supply ducting can be screwed into an adapter if necessary.

### Ducting Installation

- To connect 12” return ducting, it may be helpful to:
  1. Remove inlet grille from end cap.
  2. Connect duct to inlet grille.
  3. Reconnect inlet grille to end cap.

Note: The supply duct adapter is standard on all units. The return duct collar is an optional accessory.

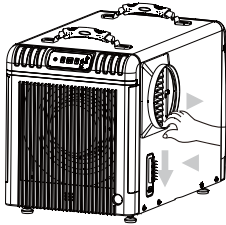

#### Removing Duct Adapter

If it is necessary to remove the adapter, place hand at bottom of the adapter and use your hands to lift out and down. This will remove the cover hooks from the machine.

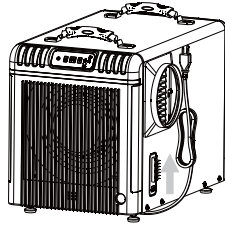

#### Installing Duct Adapter

To install adapter, line it up with holes on the side of unit and push up from base of adapter.

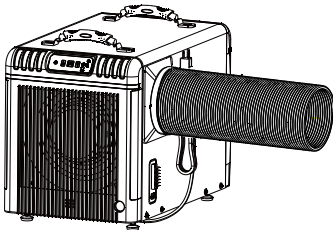

#### Flex Duct Installation

Rotate the flex duct counter-clockwise.

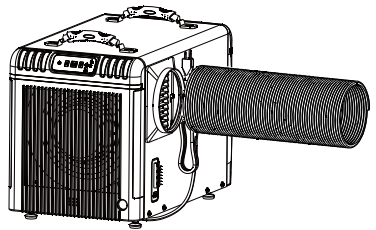

#### Flex Duct Removal

Rotate flex duct clockwise or remove wire tie.

# Troubleshooting

Symptom	Cause	Solution
Machine Won't Run	Power Supply	Verify that there is power to the outlet and that the plug is properly installed in outlet.
	Room Temperature Over 105°F (Display HI) or Below 33°F (Display LO)	The unit is outside the operating temperature range. Modify the room conditions so the temperature is between 33°-105°F and operation will commence.
Low Air Flow	Air Filter is Clogged	Clean the filter mesh according to instructions listed in manual.
	Air Inlet or Outlet is Blocked	Clear the blockage from inlet or outlet.
Loud Noise	Machine Is Not Level	Move the dehumidifier to flat, firm ground.
	Filter Mesh is Blocked	Clean the filter mesh according to instructions listed in manual.
Trouble Code: E1	E1=Humidity Sensor Issues	Check to ensure that wire is connected at both ends. If no issues are visible, the sensor may be faulty.
Trouble Code: E4	Pump has failed	Verify that the pump is working. If so, unplug the unit for two minutes, then restart.
Trouble Code: HI or LO	Room Temperature Over 105°F or Below 33°F (Display LO)	The unit is outside the operating temperature range. Modify the room conditions so the temperature is between 33°-105°F and operation will commence. If room is not out of temperature range, replace faulty sensor.
Trouble Code: E5	Refrigerant Leak	Contact Your Installer for Assistance.
Trouble Code: E3	Abnormal Coil Temperature	Contact Your Installer for Assistance.

## Pump Alarm- Trouble Code E4

If a pump alarm is shown on the display, complete the following steps:

1. Reset the unit by disconnecting the power cord and then reconnecting it.

NOTE: UNIT WILL NOT FUNCTION UNTIL ERROR CODE HAS BEEN CLEARED.

2. Manually check to see if pump is operational by pressing the drain button. Check if the pump energizes and de-energizes properly. Additionally, check to see if any water purged from the system.

3. If you haven't cleaned the system recently, check the discharge line for an obstruction, then clean the balance of the pump system (see "Maintenance" on page 8 for details).

4. Replace the hoses and/or pump, if maintenance alone isn't sufficient.

## Sentinel HDi90 Spare Parts

<b>ALL Sentinel Models-Parts</b>	
<b>Part#</b>	<b>Description</b>
S-100	Remote Control Package(cable+remote)
S-101	Remote Control
S-102	Remote Control Cable,25'
S-103	Return Duct Collar Accessory
S-106	Duct Kit Assembly(W-103+W-100)
S-107	Flexibile Supply Duct,72"
S-108	Main Control Board
S-109	Display Board
S-110	RH/Temperature Sensor
<b>Sentinel HDi90-Filters</b>	
<b>Part#</b>	<b>Description</b>
S-915	Prefilter
S-917	MERV-8 Filter

<b>Sentinel HDi90-Parts</b>	
<b>Part#</b>	<b>Description</b>
S-900	Fan Motor
S-901	Complete Fan Assembly
S-902	Fan Capacitor
S-903	Compressor
S-904	Compressor Capacitor
S-905	Coil Assembly
S-907	Condensate Pump Assembly
S-908	RH/Temperature Sensor Cable
S-909	Display Cable
S-910	CAT 5 Prot Internal Cable
S-911	Foot, adjustable

# Limited Warranty

This limited warranty starts from the date of purchase. Alorair Solutions Inc. warrants to the original purchaser that this ALORAIR product is free from manufacturing defects in material or workmanship for the limited warranty period of:

**Six (6) Month parts and labor.** This includes the shipments charges for replacement parts or unit.

**One (1) year parts and labor.** This does not include the shipment charge to send the defective product back to be repaired or replaced.

**Three (3) years parts and labor on Refrigeration System ONLY (Compressor, Condenser, and evaporator).** Transportation cost, not included.

**Five (5) years parts on Refrigeration System ONLY(Compressor, Condenser, and evaporator).** Transportation cost, not included.

This limited warranty is valid only on products purchased from the manufacturer or ALORAIR authorized dealer and operated, installed, and maintained according to the instructions included in this user guide or furnished with the product. Alorair Solutions Inc will not provide in-home service during or after the warranty period. You may be responsible for the shipping charge to bring the product to the manufacturer for service.

To receive warranty service, the purchaser must contact ALORAIR at 888-990-7469 or support@alorair.com. A proof of purchase or order number is required to receive warranty service. During the applicable warranty period, a product will be repaired or replaced at the sole option of ALORAIR.

**IMPORTANT NOTICE:** Keep the item's packaging in case warranty service is required.

## Limited Warranty Exclusions

This limited warranty covers manufacturing defects in materials or workmanship encountered in normal household, commercial or noncommercial use of this product and shall not cover the following:

- Damage occurs in uses for which this product was not intended for.
- Damage caused by unauthorized modification or alteration of the product.
- Cosmetic damage including scratches, dents, chips, and other damage to the product's finishes.
- Damage caused by abuse, misuse, pest infestation, accident, fire, floods, or other acts of nature.
- Damage caused by incorrect electrical line current, voltage, fluctuations, and surges.
- Damage caused by failure to perform proper maintenance of the product.

The use of this product in SPA or a room with OUTDOOR POOL invalidate or voids limited warranty.

— Restoration & Moisture & Ventilation —



## WARRANTY REGISTRATION CARD

**Return To:  
AlorAir Solutions**

**ORDER NUMBER:** \_\_\_\_\_

**MODEL:** \_\_\_\_\_ **SERIAL #:** \_\_\_\_\_

**INSTALLER:** \_\_\_\_\_ **INSTALLATION DATE:** \_\_\_\_\_

**NAME:** \_\_\_\_\_

**ADDRESS:** \_\_\_\_\_

**CITY:** \_\_\_\_\_ **STATE:** \_\_\_\_\_ **ZIP:** \_\_\_\_\_

**PHONE #:** \_\_\_\_\_ **EMAIL:** \_\_\_\_\_

- ▶ If you have any questions, please feel free to contact us at 888-990-7469 or visit [www.alorair.com](http://www.alorair.com)
- ▶ Register your unit for warranty using this link: [www.alorair.com/page/Warranty--Warranty-registration](http://www.alorair.com/page/Warranty--Warranty-registration)
- ▶ Warranty Registration <https://www.alorair.com> or [scan this barcode](https://www.alorair.com) to direct you to the warranty registration website.



