



OUTDOOR





INDEX



HELMETS
CASCHI p. 5_9

1

HARNESSES
IMBRACATURE p. 11_17

2

GLOVES
GUANTI p. 19_23

3

CONNECTORS AND QUICKDRAWS
CONNETTORI E RINVII p. 25_47

4

SLINGS
FETTUCCE p. 49_52

5

DESCENDERS
DISCENSORI p. 53_58

6

ROPE CLAMPS
BLOCCANTI p. 59_66

7

PULLEYS
CARRUCOLE p. 67_72

8

VIA FERRATA
KLETTERSTEIG p. 73_75

9

ANCHORING TOOLS
ANCORAGGI p. 77_81

10

WINTER LINE
LINEA INVERNALE p. 83_89

11

BAGS
SACCHI p. 91_96

12

GADGETS
GADGETS p. 97_101

13

MADE IN ITALY SINCE 1830

The origin of Kong starts from afar, around 1830 in a workshop at the foot of the Alps, where Giuseppe Bonaiti gave rise to our story, writing important pages for Made in Italy. The care for maximum protection of human lives, together with the dreams that men “hang” climbing the peaks, led Bonaiti to export his products and philosophy all over the world.

His carabiners have become real fixed points for everyone who practices vertical disciplines.

In 1977 Bonaiti company changed its name to Kong, but the mission remains the same:

“Being a manufacturer of safety where the risk is the protagonist”

The entire production cycle, from the design to the packaging is made in our factory of 10,000 square meters located in Monte Marenzo (LC), Italy, where each PPE (Personal Protective Equipment) is tested piece by piece and then sold all over the world.

We can proudly say that, first of all, we are “manufacturers”:

- our 80 employees perform their daily activities with passion to produce high quality systems that ensure maximum safety
- our robots test 100% of our items at 70% of the breaking load
- our operators check 100% of the appearance and functionality of our products

“KONG, from the past to the future, the evolution of safety”

MADE IN ITALY DAL 1830

Le origini di Kong partono da lontano, esattamente nel 1830 in un’officina meccanica situata ai piedi delle Alpi, dove Giuseppe Bonaiti ha dato inizio alla nostra storia, scrivendo pagine importanti del Made in Italy.

L’attenzione per la massima protezione delle vite umane, insieme ai sogni che questi uomini “appendono” scalando le vette, ha portato Bonaiti ad esportare in tutto il mondo la sua filosofia e i suoi prodotti.

I suoi “moschettoni” sono diventati concretamente punti fissi per chiunque pratici discipline verticali.

Nel 1977 l’azienda Bonaiti cambia nome in Kong, ma l’impronta rimane sempre la stessa:

“Essere produttori di sicurezza dove il rischio è protagonista”

L’intero ciclo di produzione, dalla progettazione al confezionamento, avviene all’interno dei 10.000 mq dello stabilimento di Monte Marenzo (LC) Italia, dove ogni DPI (Dispositivo di Protezione Individuale) viene testato pezzo per pezzo e venduto in tutto il mondo.

Con orgoglio possiamo dire di essere innanzitutto produttori:

- i nostri 80 dipendenti svolgono le loro attività quotidiane con passione, per produrre sistemi di alta qualità che garantiscono la massima sicurezza
- i nostri robots testano il 100% dei connettori trazionandoli a circa il 70% del carico marcato
- i nostri operatori controllano il 100% dei prodotti valutandone la perfetta funzionalità e l’aspetto estetico

“KONG, dal passato al futuro, l’evoluzione della sicurezza”

QUALITY CONTROL AND CERTIFICATIONS

KONG, since the beginning, has always followed strict rules to ensure that each product withstands expected loads, controlling and testing piece by piece. This means that when we design a new item, we build a prototype and have it tested by a notified body that verifies compliance with the standards. Then we put it into production with the absolute guarantee that the millionth piece is identical to the first piece produced. This also applies to the production of carry over products.

As a further guarantee to the end user, most of the KONG products are certified according to UIAA - International Climbing and Mountaineering Federation standards and to CE norms.

Many of our items are also certified according to special standards: NFPA - ANSI - RINA - ASTM - EASA or to military specifications.

Kong also followed its natural evolution towards a quality management system and has been certified for more than 20 years, today according to ISO 9001, which is applied to all our business processes.

CONTROLLO DI QUALITÀ E CERTIFICAZIONI

La KONG, fin dalle origini, si è sempre data delle regole ferree per garantire che ogni prodotto resistesse ai carichi previsti, controllandolo e testandolo pezzo per pezzo. Questo vuol dire che quando si progetta un nuovo articolo, si costruisce un prototipo, lo si fa testare da un organismo notificato che ne verifica la conformità agli standard e poi lo si mette in produzione con la garanzia assoluta che il milionesimo pezzo sia identico in tutto e per tutto al primo pezzo prodotto. Questo vale anche per la produzione di articoli consolidati.

Ad ulteriore garanzia dell’utilizzatore finale, la maggior parte dei prodotti KONG è certificata secondo gli standard UIAA (Unione Internazionale delle Associazioni Alpinistiche) e le norme CE.

Molti nostri articoli sono inoltre certificati in accordo alle norme NFPA - ANSI - RINA - ASTM - EASA o a specifiche militari.

L’organizzazione della KONG ha poi trovato la sua naturale evoluzione nel sistema di gestione per la qualità certificato da oltre vent’anni, secondo la norma UNI EN ISO 9001 applicata a tutti i processi aziendali.

Kong headquarters with private airfield N 45° 45’ 43” E 9° 26’ 47”, Monte Marenzo (Lecco) - ph: Kong



Watch the video
Guarda il video



Directive

2006/42/CEE	Machinery Directive
89/686/CEE	Personal Protective Equipment
93/42/CEE	Medical Devices

CE NORMS



EN 166		Personal eye protection	Protezione personale degli occhi
EN 341		Descender devices for rescue	Dispositivi di discesa per salvataggio
EN 353-1		Guided type fall arresters including a rigid anchor line	Dispositivi anticaduta di tipo guidato comprendenti una linea di ancoraggio rigida
EN 353-2		Guided type fall arresters including a flexible anchor line	Dispositivi anticaduta di tipo guidato comprendenti una linea di ancoraggio flessibile
EN 354		Lanyards	Cordini
EN 355		Energy absorbers	Assorbitori di energia
EN 358		Belts for work positioning and restraint and work positioning lanyards	Cinture di posizionamento sul lavoro e di trattenuta e cordini di posizionamento sul lavoro
EN 360		Retractable type fall arresters	Dispositivi anticaduta di tipo retrattile
EN 388		Protective gloves against mechanical risk	Guanti di protezione contro i rischi meccanici
EN 361		Full body harnesses	Imbracature per il corpo
EN 362		Connectors	Connettori
EN 363		Personal fall protection systems	Sistemi individuali per la protezione contro le cadute
EN 397		Industrial safety helmets	Elmetti di protezione per l'industria
EN 420		Protective gloves	Guanti di protezione
EN 564	UIAA 102	Accessory cord	Cordino
EN 565	UIAA 103	Tape	Fettuccia
EN 566	UIAA 104	Slings	Anelli
EN 567	UIAA 126	Rope clamps	Bloccanti
EN 568	UIAA 151	Ice anchors	Ancoraggi da ghiaccio
EN 569	UIAA 122	Pitons	Chiodi
EN 795		Anchor devices	Dispositivi di ancoraggio
EN 813		Sit harnesses	Cinture con cosciali
EN 892	UIAA 101	Dynamic mountaineering ropes	Corde dinamiche per alpinismo
EN 893	UIAA 153	Crampons	Ramponi
EN 958	UIAA 128	Energy absorbing systems for use in Klettersteig climbing	Dissipatori d'energia utilizzati nelle ascensioni per via ferrata
EN 959	UIAA 123	Rock anchors	Chiodi da roccia
EN 1496		Rescue lifting devices	Dispositivi di sollevamento per il salvataggio
EN 1498		Rescue loops	Cinghie di salvataggio
EN 1891	UIAA 107	Low stretch kernmantel ropes.	Corde con guaine a basso coefficiente di allungamento.
EN 12270	UIAA 124	Chocks	Blocchi da incastro
EN 12275	UIAA 121	Connectors	Connettori
EN 12276	UIAA 125	Frictional anchors	Ancoraggi regolabili
EN 12277	UIAA 105	Harnesses	Imbracature
EN 12278	UIAA 127	Pulleys	Pulegge
EN 12492	UIAA 106	Helmets for mountaineers	Caschi per alpinisti
EN 12841		Rope access systems Rope adjustment devices	Sistemi di accesso con fune Dispositivi di regolazione della fune
EN 13089	UIAA 152	Ice-tools	Utensili da ghiaccio
EN 15151-1		Semi-automatic descender devices	Discensori semi-automatici
EN 15151-2		Manual descender devices	Discensori manuali

Many of our products comply also to NFPA, ANSI, NIT, Russian and Brazilian norms.
Molti dei nostri prodotti sono conformi anche alle norme NFPA, ANSI, NIT e specifiche norme Russe e Brasiliane.

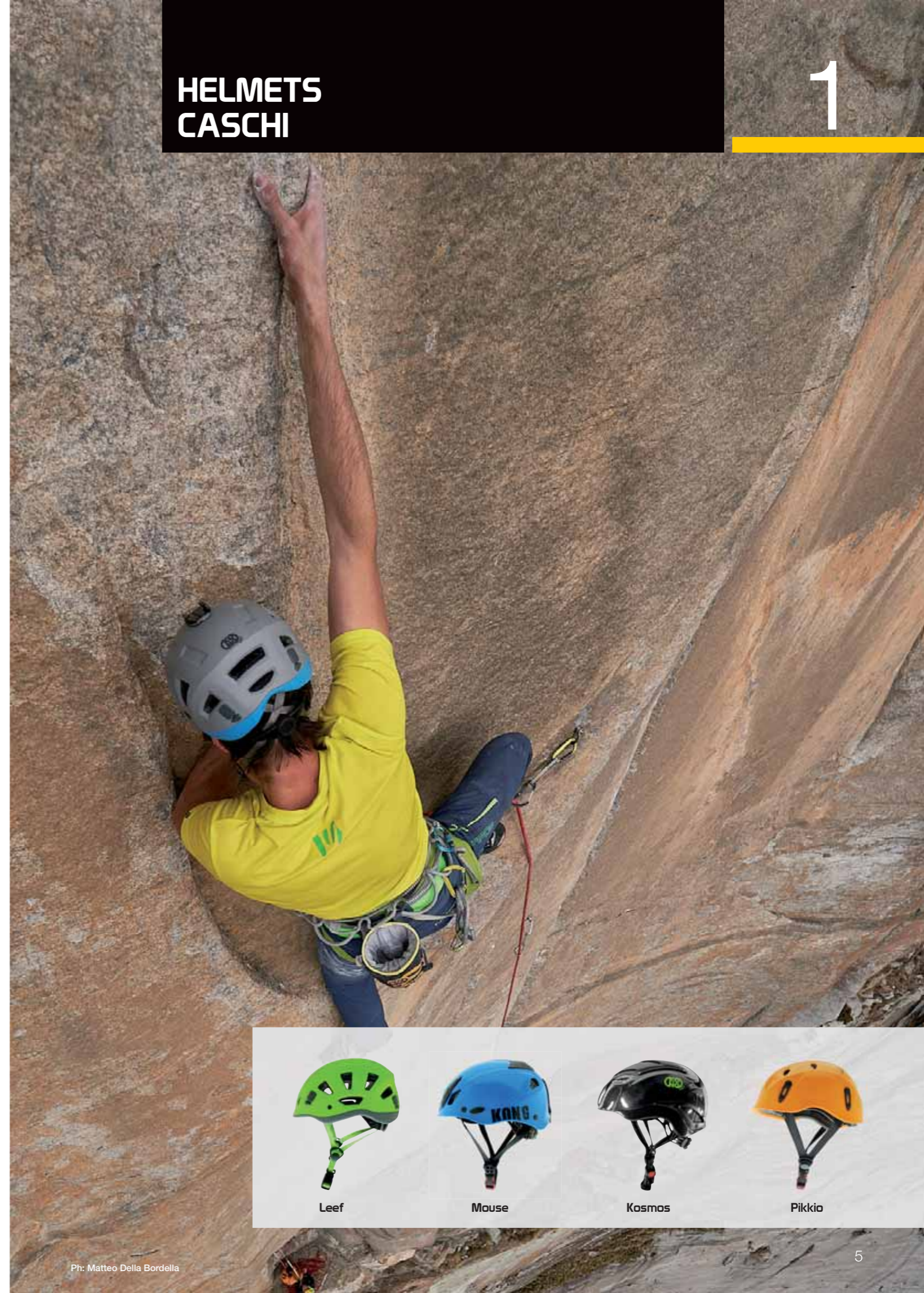

Leef



Mouse



Kosmos



Pikio

LEEF

- ULTRA LIGHT HELMET
- You no longer have to choose between lightness and comfort!
This new Kong helmet, thanks to its wide internal padding, provides maximum comfort in just 230g. The molding technology of the external polycarbonate layer, with internal high density polystyrene, provides exceptional shock resistance and an incredibly reduced weight.
- Certified to CE EN 12492 for climbing, mountaineering and ski-mountaineering.
- The Leef is a great example of structural minimalism. The material that gives it strength is minimized, and present only where necessary. That is what we had in mind during the development of this helmet. Wear it, you'll forget you have it on!
- CASCO ULTRA LEGGERO
- Da oggi non dovrai più scegliere tra leggerezza e comodità! Il nuovo casco Kong, grazie all'ampia imbottitura interna, offre il massimo comfort in soli 230 g di peso. La tecnologia di costampaggio dello strato esterno in policarbonato con il polistirene ad alta densità interno, garantisce una resistenza eccezionale agli urti e un peso incredibilmente contenuto.
- Omologato per arrampicata, alpinismo e scialpinismo CE EN 12492
- La foglia è un ottimo esempio di minimalismo strutturale, la materia che la sostiene e le dona resistenza è ridotta al minimo ed è presente solo dove serve. A questo ci siamo ispirati per lo sviluppo di questo casco. Prova ad indossarlo, ti dimenticherai di averlo in testa!



LEEF 
real comfort in just 230 g
vero comfort in soli 230 g



#	Standards	Material	Color	g	Size	Cm
997002G00KK	EN 12492	polycarbonate		230	UNI	54/61
997002R00KK	EN 12492	polycarbonate		230	UNI	54/61
997002D00KK	EN 12492	polycarbonate		230	UNI	54/61
997002W00KK	EN 12492	polycarbonate		230	UNI	54/61
997002A00ZK*	EN 12492	polycarbonate		230	UNI	54/61
997002D00ZK*	EN 12492	polycarbonate		230	UNI	54/61

* CAI version - Versione CAI

MOUSE

- Light, comfortable and well-ventilated helmet, recommended for mountaineering, rock climbing, via ferrata and adventure parks.
- Ultra-durable ABS shell, polyester strap with buckle, and quick size adjustment via the wheel regulation system.
- Equipped with marked holes for attaching headphones and visor. Available in the WORK version certified to CE EN 397.
- Universal size (52-64 cm).
- Available in various colors (blue, white, red, black and high visibility), and with a special rubberized black "Soft Touch" finish.
- HV (high visibility) version in fluo yellow color with reflective stickers.
- Casco confortevole e ben aereato, consigliato per alpinismo, arrampicata, vie ferrate e parchi avventura.
- Calotta in ABS ultraresistente, cinturino in poliestere con chiusura a scatto, regolazione rapida della taglia tramite sistema a rotella.
- Dotato di fori pre-segnati per il fissaggio di cuffie e visiera. Disponibile in versione WORK certificata CE EN 397.
- Taglia unica (52-64 cm).
- Disponibile in vari colori (blu, bianco, rosso, nero e alta visibilità) anche con speciale finitura gommata nera "Soft Touch".
- Versione HV (alta visibilità) in colore giallo fluo e adesivi rifrangenti.



Available in the WORK version conforming to CE EN 397.

Disponibile in versione WORK conforme alla norma CE EN 397.



#	Standards	Material	Color	g	Size	Cm
99716AA02KK	EN 12492	ABS		375	UNI	52/64
99716AN02KK	EN 12492	ABS		375	UNI	52/64
99716AR02KK	EN 12492	ABS		375	UNI	52/64
99716AW02KK	EN 12492	ABS		375	UNI	52/64
99716FY02KK	EN 12492	ABS		380	UNI	52/64
99716GN02KK	EN 12492	ABS		375	UNI	52/64



KOSMOS

- Innovative multi-sport helmet certified for mountaineering-climbing and skiing. Made with "in moulding system" technique, that ensures maximum lightness and strength. Kosmos can be equipped with earmuffs and internal removable cap (not included) that allow you to quickly transform from lightweight helmet for climbing to a warm and comfortable winter version for skiing.
- Available in two colors, black and white with "carbon" finishing and in two sizes: size S/M (53÷58 cm) weight 390g / size L/XL (58÷62 cm) weight 395g.
- Innovativo casco multi-sport, certificato per alpinismo-arrampicata e sci. Realizzato con tecnica "in moulding system" che garantisce la massima leggerezza e resistenza. Kosmos può essere dotato di accessori paraorecchi e cuffia interna amovibili (non inclusi) che permettono di trasformarlo velocemente da leggero casco per l'arrampicata a calda e confortevole versione invernale per lo sci.
- Disponibile in due colorazioni, bianco e nero con finitura "carbon" e in due taglie: taglia S/M (53÷58 cm) peso 390g / taglia L/XL (58÷62 cm) peso 395g.



Black

White



#	Standards	Material	Color	g	Size	Cm
KOSMOS						
997100N02KK	EN 12492 EN 1077	polycarbonate	■	385	S/M	53/58
997100N04KK	EN 12492 EN 1077	polycarbonate	■	415	L/XL	58/62
997100W02KK	EN 12492 EN 1077	polycarbonate	□	385	S/M	53/58
997100W04KK	EN 12492 EN 1077	polycarbonate	□	415	L/XL	58/62
KOSMOS FULL						
997105N02KK	EN 12492 EN 1077	polycarbonate	■	455	S/M	53/58
997105N04KK	EN 12492 EN 1077	polycarbonate	■	485	L/XL	58/62
997105W02KK	EN 12492 EN 1077	polycarbonate	□	455	S/M	53/58
997105W04KK	EN 12492 EN 1077	polycarbonate	□	485	L/XL	58/62

KOSMOS CAP

- Removable cap designed for the Kosmos helmet.
- Easy to wash and made with anti-mold fabric.
- Sottocasco rimovibile specifico per casco mod. Kosmos.
- Facilmente lavabile e realizzato in materiale antimuffa.



#	Material	Color	g	Size
997102N02KK	polyester	■	30	S/M
997102N04KK	polyester	■	30	L/XL

KOSMOS EAR PROTECTION

- Removable snap earmuff.
- They allow the Kosmos helmet to be adapted for winter and ski use.
- Available in two different colors for perfect color matching with the two Kosmos models.
- Paraorecchie a scatto rimovibili, specifici per casco mod. Kosmos.
- Permettono di trasformare il casco Kosmos per l'utilizzo invernale e lo sci.
- Disponibili in due colori, bianco e nero, in perfetto abbinamento cromatico con le due colorazioni del Kosmos.



Black

White

#	Material	Color	g	Size
997101N01KK	-	■	45	-
997101W01KK	-	□	45	-

PIKKIO

- Helmet for kids, one size adjustable (48-57 cm).
- Casco da bambino, taglia UNI regolabile (48-57 cm).



Orange

#	Standards	Material	Color	g	Size	Cm
997006O00KK	EN 12492	ABS	■	340	UNI	48/57

KLIK 2

- Compact and powerful headlamp (up to 120 meter beam).
- Powered by 3 AAA type battery, up to 180 hours of light!
- Front bulb for depth and lateral LED for diffused light.
- 7 modes (front bulb: medium, high, low and strobe SOS - lateral LED: high, low and strobo SOS).
- IPX6 waterproof protection class.
- Lampada frontale compatta e potente (fino a 120 m di profondità del fascio luminoso).
- Funziona con 3 batterie stilo tipo AAA, lunga durata (fino a 180 ore di utilizzo).
- Lunga durata delle batterie.
- Lampadina frontale di profondità e LED laterali per luce diffusa.
- 7 modi d'uso (lampadina frontale: luce media, alta, bassa e strobo SOS - LED laterali: luce alta, bassa e strobo SOS).
- Impermeabilità: IPX6, resistente all'acqua.



KLIK MICRO

- Ultra compact headlamp recommended for use in camping, at mountain retreats or in case of emergency.
- It can be attached as a signaling light on a bicycle saddle or on a backpack via the metal clip.
- Front bulb for depth and lateral red LED for signaling.
- Powered by 2 CR2032 type batteries.
- 4 modes (front bulb: high and low - red LED: fixed and SOS strobe).
- IPX6 waterproof protection class.
- Lampada frontale ultracompatto consigliata per utilizzo in tenda, in rifugio o come lampada di emergenza.
- Può essere utilizzata come luce di segnalazione montata sulla sella di una bicicletta oppure fissandola sullo zaino tramite la clip a molla; l'elastico può essere rimosso.
- Lampadina frontale di profondità e LED rossi per luce di segnalazione.
- Funziona con 2 batterie a bottone tipo CR2032.
- 4 modi d'uso (lampadina frontale: luce alta e bassa - LED rossi: luce fissa e strobo SOS).
- Impermeabilità: IPX6, resistente all'acqua.



#	Output lumen	Beam depth m	Battery life h	Color	g
KLIK 2					
951010B00KK	122	120	180	■	56
951010O00KK	122	120	180	■	56
KLIK MICRO					
951011B00KK	25	25	96	■	24
951011O00KK	25	25	96	■	24

HARNESSES IMBRACATURE

2



Up



Target Canyon



Indiana Canyon



Indiana



Secur Eight II



Target Cave



Indiana Full II



GoGo

UP

- New high quality climbing and mountaineering harness, made in Italy.
- Equipped with 4 gear loops, with adjustable leg loops and indestructible steel buckles, it is designed for all types of climbing.
- Nuova imbracatura per arrampicata e alpinismo, di alta qualità, realizzata in Italia.
- Dotata di 4 porta-materiali, con cosciali regolabili e indistruttibili fibbie in acciaio, è studiata per ogni tipo di scalata.



#	Standards	Material	Color	g	Size	A cm	B cm
8C0862000KK	EN 12277/C	-	■ ■	480	S	70/80	47/57
8C0863000KK	EN 12277/C	-	■ ■	500	M	75/85	51/61
8C0864000KK	EN 12277/C	-	■ ■	520	L	80/90	55/65
8C0865000KK	EN 12277/C	-	■ ■	540	XL	85/95	59/69

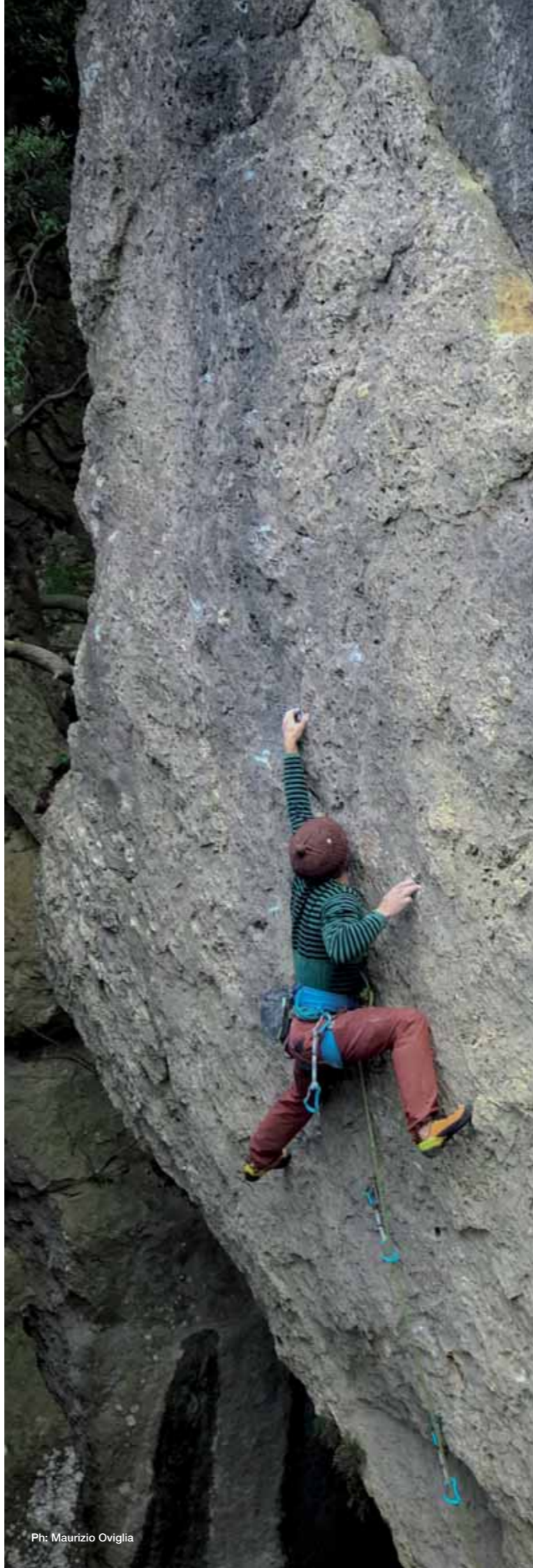

Ph: Maurizio Oviglia

WWW.KONG.IT

TARGET CANYON

- Canyoning harness that combines the comfort of a mountaineering harness with the abrasion-resistance and shape necessary for caving and canyoning.
- Provided with a special front attachment point that can accommodate a quick link and allow a chest ascender to be connected in a lower position. During the ascent phase, you gain 10-15 cm more height for each push.
- The quick link can also be used as an auxiliary attachment point, ideal for rescue maneuvers.
- Frontal sling to attach the descender and avoid risk of loss.
- Equipped with two small lateral holes for attaching a lanyard and descender.
- Two strong gear loops made of thin tape function smoothly with carabiners and reduce weight.
- Extremely durable protective seat made of coated PVC is easily removable via Velcro for maintenance, cleaning and replacement.
- Four rear slots to accommodate isolated material. These allow you to fully customize your equipment layout and facilitate identification.
- Two reinforced rear slots to accommodate 2 reserve quick links that can be used as additional gear holders or to hang a small emergency bag (bolts, keys, medical kit...) during tricky exploration phases.
- Successfully tested in the Himalaya in the highest canyon in the world.
- Highest quality and attention to detail.
- Imbragatura da torrentismo che unisce il confort di un imbrago da alpinismo alla resistenza e alla impostazione speleo/canyoning.
- Dotata di speciale ponticello anteriore che permette il montaggio di una maglia rapida per la connessione del bloccante ventrale in posizione ribassata - in fase di risalita, ad ogni pompata si guadagnano 10/15 cm.
- La maglia rapida può essere usata come punto di attacco ausiliario, soluzione ideale per manovre di soccorso ed auto-soccorso.
- Fettuccia anteriore cucita, con funzione di "fusibile" per manovre di emergenza ed auto-soccorso. Posizionamento ideale del discensore.
- Dotata di speciali asole laterali per il posizionamento di moschettoni specifici con la funzione di alloggiamento longe e discensore.
- Due solidi anelli porta-materiale, realizzati in robusta fettuccia cucita per facilitare l'utilizzo ed agevolare il passaggio di moschettoni di varia misura, evitandone l'impiglio e contribuendo alla riduzione del peso.
- Patella di protezione estremamente resistente, realizzata in PVC spalmato, facilmente removibile tramite Velcro per manutenzione, pulizia e sostituzione.
- 4 asole posteriori per ospitare materiale isolato che permettono di personalizzare al massimo la disposizione dell'attrezzatura, facilitandone l'immediata individuazione.
- 2 asole posteriori rinforzate per ospitare 2 maglie rapide di riserva utilizzabili come ulteriori porta-materiale oppure per agganciare specifica borsa a rete con set di emergenza (spit, piantaspit, chiavi, piccolo kit sanitario...) durante le delicate fasi di esplorazione.
- Testato con grande successo in Hymalaya nei canyon più alti al mondo.
- Alta qualità e cura del dettaglio.

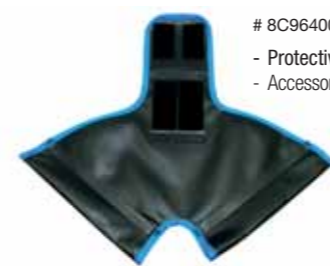

8C964000KK
- Protective seat spare part.
- Accessorio patella di protezione.



#	Standards	Material	Color	g	Size	A cm	B cm
8C0642000KK	EN 12277/C	nylon/PVC	■ ■	830	S/M	68/96	45/65
8C0644000KK	EN 12277/C	nylon/PVC	■ ■	880	L/XL	80/130	55/80

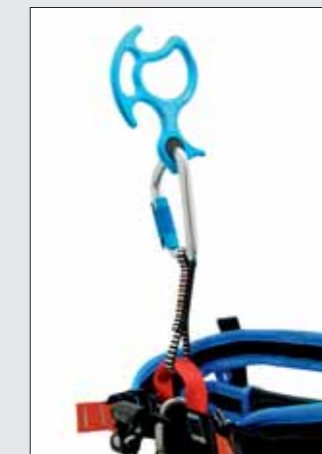

INDIANA

- Harness for mountaineering, climbing, via ferrata and adventure parks. Lightweight, with 3 adjustable straps for waist and legs providing a fully adjustable universal fit.
- Due to its continuous webbing, the size is adaptable to both adults and children aged 12 years and over.
- Equipped with a wide lateral gear loop.
- The protective seat of the Target Canyon can be attached to create a basic canyoning harness.
- Imbracatura per alpinismo, arrampicata, vie ferrate e parchi avventura. Leggerissima, con 3 fettucce regolabili per vita e gambe, misura universale ampiamente regolabile.
- Grazie alla fettuccia continua, la taglia è adattabile sia agli adulti che ai bambini dai 12 anni in su.
- Dotata di un ampio anello porta-materiale laterale.
- È possibile montare la patella di protezione della Target Canyon per trasformarla in imbrago da canyoning.



INDIANA CANYON



#	Standards	Material	Color	g	Size	A cm	B cm
INDIANA							
8C0670000KK	EN 12277/C	-	■ ■	380	UNI	60/120	42/66
INDIANA CANYON							
8C0670001KK	EN 12277/C	nylon/PVC	■ ■	635	UNI	60/120	42/66

SECUR EIGHT II

- Chest harness to be used in combination with a seat harness.
- Universal size.
- Imbracatura pettorale anti-ribaltamento, da utilizzare in combinazione con una imbracatura bassa.
- Taglia universale.



#	Standards	Material	Color	g	Size	A cm
8C1020000KK	EN 12277/D	-	■	250	UNI	75/110

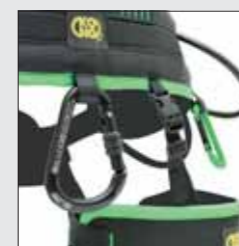

#	Standards	Material	Color	g	Size	A cm	B cm	C cm
LOW PART								
8W9502000KK	EN 12277/C EN 813	mix	■ ■	600	S	-	60/95	40/60
8W9503000KK	EN 12277/C EN 813	mix	■ ■	660	M/L	-	75/110	50/70
8W9505000KK	EN 12277/C EN 813	mix	■ ■	720	XL	-	85/130	65/78
UPPER PART								
8W9512000KK	EN 12277/C EN 813	mix	■ ■	390	S	75/85	-	-
8W9513000KK	EN 12277/C EN 813	mix	■ ■	400	M-L/XL	86/110	-	-

TARGET CAVE

- Newly developed harness for caving and rescue, designed to improve comfort and safety in rope progression.
- SPORT (CE EN 12277) and WORK (CE EN 813) CERTIFICATIONS which also allow use in the professional field or for rescue teams. The SMART chest harness can be integrated to form a complete FALL ARRESTER (CE EN 361) harness that can be used in helicopter rescue operations, by caving rescue or canyon rescue teams.
- The SMART chest harness positions the chest ascender by means of retractable, adjustable webbing and is equipped with loops for carabiners.
- The sit harness and the chest harness are connected by an extension joint with a lark's foot knot.
- Main features:
 - wide ventral waist band and padded leg loops make it very comfortable during suspension, even when transporting heavy materials, thanks to the load distribution
 - the descender's main attachment point is raised compared to a classic caving harness, which keeps the body's centre of gravity in a lower position, improving sitting comfort and balance
 - conceived with the modern needs of exploratory caving in mind, it is also oriented for chimney climbing and subterranean ascent
 - the main belay loop allows the descender good torsional mobility, avoiding critical twisting that can occur between descenders and closing quick links
 - secondary attachment point for connecting a chest ascender: thanks to a webbing bridge sewn between the leg loops, the ascender is in a lower position
 - 4 large lateral tubular gear loops (max load 10 kg)
 - 4 belt transport loops offering a high attachment point for a tool bag when moving on unstable slopes or for carrying bolting bags (max load 50 kg)
 - barycentric sling attachment for bag transportation (max load 50 kg). Easy to adjust and replace, with two hanging points according to the user's ergonomics
 - padding made of strong nylon to withstand abrasion in meanders and bottlenecks
 - sturdy buckles that can be easily adjusted using a looped piece of cord
 - elastic retaining straps in the leg loops which are easy to replace
- Imbracatura di nuova concezione per speleologia e soccorso, progettata per migliorare il comfort e la sicurezza nella progressione su corda.
- CERTIFICAZIONE SPORT (CE EN 12277) e LAVORO (CE EN 813) che consente l'utilizzo anche in ambito professionale o per le squadre di soccorso. Può essere integrata con il pettorale SMART, trasformandosi così in un'imbracatura completa ANTICADUTA (CE EN 361) utilizzabile anche nelle operazioni di soccorso con elicottero per lo sbarco al verricello delle squadre di soccorso speleologico o in canyon.
- Il pettorale SMART consente il mantenimento in posizione del bloccante ventrale mediante fettuccia regolabile a scomparsa ed è dotato di asole per l'aggancio di moschettoni porta-materiale.
- Il collegamento tra imbracatura e pettorale avviene tramite una prolunga raccordabile a bocca di lupo.
- Caratteristiche principali:
 - ampio fascione ventrale e cosciali imbottiti che la rendono molto confortevole in sospensione, anche nel trasporto di materiali pesanti grazie alla ripartizione del carico sui fianchi
 - attacco principale del discensore in posizione rialzata rispetto alla classica impostazione dell'imbracatura speleo, che mantiene il baricentro del corpo più basso, con confort di seduta e bilanciamento migliorati
 - progettata pensando alle moderne esigenze della speleologia esplorativa, orientata anche alla risalita in arrampicata di camini e pareti sotterranee
 - l'attacco principale a ponte in fettuccia consente al discensore una buona mobilità torsionale, evitando le torsioni critiche tra moschettoni del discensore e maglia di chiusura
 - attacco secondario per il collegamento del bloccante ventrale: grazie ad un ponte in nastro cucito tra i cosciali il bloccante si mantiene basso come in una imbracatura classica
 - 4 ampi portamateriali tubolari laterali (carico max 10 kg)
 - 4 asole di trasporto in cintura per un aggancio alto del sacco tubolare nel trasporto su pendii instabili o per il trasporto di sacche armo (carico max 50 kg)
 - attacco baricentrico in fettuccia per il trasporto dei sacchi (carico max 50 kg), di facile regolazione e sostituzione, con due posizioni di aggancio in funzione dell'ergonomia dell'utilizzatore
 - imbottiture rivestite in nylon con elevata resistenza all'abrasione per l'utilizzo in meandri e strettoie
 - robuste fibbie facilmente regolabili tramite asola di cordino
 - fettucce elastiche di mantenimento in posizione dei cosciali, facilmente sostituibili



INDIANA FULL II

- Full body harness for adventure parks.
- The upper straps keep the body inside the harness in case of rollover, increasing safety.
- Ultra-fast fitting, thanks to the automatic buckle used for connecting the upper part.
- Leg loops with different colors allow easy dressing.
- Easy and intuitive size regulation.
- Universal size that fits both adults and children.
- Wide aluminum ventral attachment point.
- New aluminum dorsal attachment point.
- Imbracatura completa per parchi avventura.
- La parte alta evita lo sfilamento in caso di ribaltamento aumentando notevolmente la sicurezza.
- Vestizione ultra-rapida grazie alla fibbia automatica di collegamento della parte alta.
- Colorazione differenziata dei cosciali per facilitare la vestizione.
- Regolazione semplice e intuitiva.
- Taglia unica adatta sia agli adulti che ai bambini.
- Ampio punto d'attacco ventrale in alluminio.
- Nuovo punto d'attacco dorsale in alluminio.



#	Standards	Material	Color	g	Size	A cm	B cm	C cm
8C0690001KK	EN 12277/C	-	■	1025	UNI	-	-	-

GOGO

- GoGo is the new fullbody harness conform to EN 12277 / B for children up to 40 kg.
- The adjustment is extremely easy and safe and allows to fit the harness to children with height between 90 and 135 cm.
- Fitted with 4 adjustment buckles (2 on leg loops and 2 on the shoulder straps).
- Sternal attachment point of high visibility color for easy check of the correct connection.
- Different colours leg loops for an easy dressing.
- Textile dorsal attachment point that guarantees comfort, reduces weight and allows the belay even from behind.
- High resistance webbing with rolled terminal for ease tension.
- Wide gear loops high strength.
- Circular seams that distribute loads evenly in all directions.
- GoGo è la nuova imbragatura omologata EN 12277/B per bambini fino a 40 kg.
- La regolazione è estremamente facile e sicura e permette di adattare l'imbrago a bambini di altezza compresa tra 90 e 135 cm.
- Dotata di 4 fibbie di regolazione (2 sui cosciali e 2 sulle bretelle).
- Punto d'attacco sternale di colore a contrasto per una facile verifica della corretta connessione.
- Cosciali di colorazione differenziata per facilitare la vestizione.
- Punto d'attacco dorsale tessile che garantisce confort, riduce il peso e permette l'assicurazione anche da dietro.
- Fettucce ad alta resistenza con terminale arrotolato che ne facilita il tensionamento.
- Ampi porta materiali ad alta resistenza.
- Cuciture circolari che distribuiscono i carichi omogeneamente in ogni direzione.

GOGO

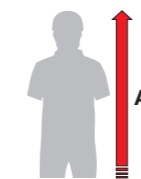

#	Standards	Material	Color	g	Size	A cm
8C0150000KK	EN 12277/B	-	■ ■	520	UNI	90/135





Pro Gloves



Pro Air Gloves



Skin Gloves



Full Gloves



Alex Gloves



Canyon Gloves



Pop Gloves

PRO GLOVES

- Strong leather gloves conceived for belay and double rope use, they combine the strength of a work glove with the precision and sensitivity of a thin glove.
- Excellent also for use in work and rescue situations.
- The double-layered leather protects the most exposed parts of the hand.
- Elastic wrist with Velcro closure.
- Made of smooth and soft leather for a perfect balance between strength and sensitivity.
- Guanti resistenti in pelle per assicurazione e doppie che combinano la robustezza di un guanto da lavoro con la precisione e la sensibilità di un guanto sottile.
- Ottimi anche per l'utilizzo in situazioni di lavoro e soccorso.
- La pelle doppio strato protegge le parti più esposte della mano.
- Polso elastico con chiusura in Velcro.
- Fabbricato in pelle di alta qualità per un perfetto equilibrio tra robustezza e sensibilità.

PRO AIR GLOVES

- Smoother and lighter version with full elastic back, made with breathable nylon, abrasion-resistant that ensures optimum wearability and comfort.
- Reinforced palm with extra suede layer.
- Versione più soffice e leggera con dorso completamente in nylon elastico traspirante, resistente all'abrasione, che garantisce comfort e ottima vestibilità.
- Palmo rinforzato con uno strato di pelle scamosciata.

SKIN GLOVES

- Lightweight gloves conceived for belay and double rope use, that combine the strength of a work glove with the precision and the sensitivity of a thin glove.
- Excellent also for the use in work and rescue situations.
- The double-layered skin protects the most exposed parts of the hand.
- The elastic back, made with breathable nylon, resists abrasion and ensures optimum wearability and comfort.
- Elastic wrist with Velcro closure.
- Made of smooth and soft leather for a perfect balance between strength and sensitivity.
- Reinforced thumb and index with special rubber for durability during the rope handling.
- Available in 4 sizes from S to XL.
- Certified CE EN 388 (4-2-4-3).
- Guanti leggeri per assicurazione e doppie che combinano la robustezza di un guanto da lavoro con la precisione e la sensibilità di un guanto sottile.
- Ottimi anche per l'utilizzo in situazioni di lavoro e soccorso.
- La pelle doppio strato protegge le parti più esposte della mano.
- Il dorso in nylon elastico traspirante resiste all'abrasione e garantisce comfort e ottima vestibilità.
- Polso elastico con chiusura in Velcro.
- Fabbricato in pelle naturale «alta qualità» per un perfetto equilibrio tra robustezza e sensibilità.
- Polpastrello di pollice e indice rinforzato in gomma speciale per la massima resistenza durante la gestione della corda.
- Disponibile in 4 taglie, dalla S alla XL.
- Certificati CE EN 388 (4-2-4-3).

FULL GLOVES

- High quality leather gloves with Kevlar reinforcement on palm and fingers, the perfect choice for via ferrata, adventure parks and rescue.
- Elastic wrist with Velcro closure ensures a great fit.
- The elastic back, made with breathable nylon, resists abrasion and ensures the best wearability and confort.
- Available in 5 sizes (S, M, L, XL, XXL).
- Certified CE EN 388 (4-2-4-3) and CE EN 420.
- Available Aero version with reinforced right palm.
- Guanti di alta qualità realizzati in pelle con rinforzo in Kevlar su palmo e dita, ideali per vie ferrate, parchi avventura, soccorso.
- Polso elastico con chiusura in Velcro che garantisce un ottima vestibilità.
- Dorso in Nylon elasticizzato traspirante e resistente all'abrasione.
- Disponibili in 5 taglie (S, M, L, XL, XXL).
- Certificati CE EN 388 (4-2-4-3) e CE EN 420.
- Disponibile in versione Aero con palmo destro rinforzato.



AERO version with reinforced right palm.
Versione AERO con palmo destro rinforzato



#	Standards	Material	Color	g	Size
95207NNN3KK	EN 388:2003	leather/nylon	■	135	M
95207NNN4KK	EN 388:2003	leather/nylon	■	145	L
95207NNN5KK	EN 388:2003	leather/nylon	■	155	XL

#	Standards	Material	Color	g	Size
95208NNN5KK	EN 388:2003	leather/suede/nylon	■	135	XL

#	Standards	Material	Color	g	Size
95205N002KK	EN 388:2003	suede/nylon/rubber	■	75	S
95205N004KK	EN 388:2003	suede/nylon/rubber	■	80	M
95205N006KK	EN 388:2003	suede/nylon/rubber	■	85	L
95205N007KK	EN 388:2003	suede/nylon/rubber	■	90	XL

#	Standards	Material	Color	g	Size
95203YWF2KK	EN 388:2003 EN 420:2003	kevlar reinforced suede	■ ■ ■	105	S
95203YWF4KK	EN 388:2003 EN 420:2003	kevlar reinforced suede	■ ■ ■	110	M
95203YWF6KK	EN 388:2003 EN 420:2003	kevlar reinforced suede	■ ■ ■	115	L
95203YWF7KK	EN 388:2003 EN 420:2003	kevlar reinforced suede	■ ■ ■	120	XL
95203YWF8KK	EN 388:2003 EN 420:2003	kevlar reinforced suede	■ ■ ■	125	XXL
95203NNN3KK	EN 388:2003 EN 420:2003	kevlar reinforced suede	■	105	S
95203NNN4KK	EN 388:2003 EN 420:2003	kevlar reinforced suede	■	110	M
95203NNN6KK	EN 388:2003 EN 420:2003	kevlar reinforced suede	■	115	L
95203NNN7KK	EN 388:2003 EN 420:2003	kevlar reinforced suede	■	120	XL
95203NNN8KK	EN 388:2003 EN 420:2003	kevlar reinforced suede	■	125	XXL

DuPont™ and Kevlar® are trademarks or registered trademarks of E.I. du Pont de Nemours and Company.

ALEX GLOVES

- High quality leather gloves with Kevlar reinforcement on palm and fingers, the perfect choice for via ferrata, adventure parks and rescue.
- With 3 fingers cut to 3/4.
- Elastic wrist with Velcro closure ensures a great fit.
- The elastic back, made with breathable nylon, resists abrasion and ensures the best wearability and comfort.
- Available in 6 sizes (S, M, L, XL, XXL, XXXL).
- Certified CE EN 388 (4-2-4-3) and CE EN 420.
- Guanti di alta qualità realizzati in pelle con rinforzo in Kevlar su palmo e dita, ideali per vie ferrate, parchi avventura, soccorso.
- Con 3 dita tagliate a 3/4.
- Polso elastico con chiusura in Velcro che garantisce un'ottima vestibilità.
- Dorso in Nylon elasticizzato traspirante e resistente all'abrasione.
- Disponibili in 6 taglie (S, M, L, XL, XXL, XXXL).
- Certificati CE EN 388 (4-2-4-3) e CE EN 420.



CANYON GLOVES

- Neoprene gloves reinforced with DuPont™ Kevlar® fibers on the palm and fingers, for use in aquatic situations and canyoning.
- Equipped with a hook for hanging them on a harness or backpack.
- Convenient Velcro closure on the wrist for the perfect fit.
- Available in 5 sizes (S, M, L, XL, XXL).
- Guanti in neoprene con rinforzo in DuPont™ Kevlar® su palmo e dita per utilizzo in canyoning e situazioni acquatiche.
- Dotati di gancio per appenderli all'imbrago o allo zaino.
- Comoda chiusura in Velcro sul polso per la regolazione della taglia.
- Disponibili in 5 taglie (S, M, L, XL, XXL).



POP GLOVES

- High quality leather gloves ideal for via ferrata, adventure parks and rescue.
- With fingers cut to 3/4 length.
- Elastic wrist with Velcro closure ensures a great fit.
- The elastic back, made with breathable nylon, is abrasion-resistant and ensures the best wearability and comfort.
- Available in 6 sizes (XS, S, M, L, XL, XXL).
- Guanti di alta qualità ideali per vie ferrate, parchi avventura, soccorso.
- Con dita tagliate a 3/4.
- Polso elastico con chiusura in Velcro che garantisce un'ottima vestibilità.
- Dorso in nylon elasticizzato traspirante e resistente all'abrasione.
- Disponibili in 6 taglie (XS, S, M, L, XL, XXL).



#	Standards	Material	Color	g	Size
95201YWF1KK	EN 388:2003 EN 420:2003	kevlar reinforced suede	■ ■ ■	59	XS
95201YWF2KK	EN 388:2003 EN 420:2003	kevlar reinforced suede	■ ■ ■	60	S
95201YWF4KK	EN 388:2003 EN 420:2003	kevlar reinforced suede	■ ■ ■	63	M
95201YWF6KK	EN 388:2003 EN 420:2003	kevlar reinforced suede	■ ■ ■	68	L
95201YWF7KK	EN 388:2003 EN 420:2003	kevlar reinforced suede	■ ■ ■	72	XL
95201YWF8KK	EN 388:2003 EN 420:2003	kevlar reinforced suede	■ ■ ■	75	XXL
95201YWF9KK	EN 388:2003 EN 420:2003	kevlar reinforced suede	■ ■ ■	80	XXXL

#	Standards	Material	Color	g	Size
95204NN02KK	EN 388:2003 EN 420:2003	neoprene/reinforced with Kevlar®	■	110	S
95204NN04KK	EN 388:2003 EN 420:2003	neoprene/reinforced with Kevlar®	■	117	M
95204NN06KK	EN 388:2003 EN 420:2003	neoprene/reinforced with Kevlar®	■	126	L
95204NN07KK	EN 388:2003 EN 420:2003	neoprene/reinforced with Kevlar®	■	127	XL
95204NN08KK	EN 388:2003 EN 420:2003	neoprene/reinforced with Kevlar®	■	136	XXL

DuPont™ and Kevlar® are trademarks or registered trademarks of E.I. du Pont de Nemours and Company.

#	Standards	Material	Color	g	Size
95202BN09KK	-	leather/nylon/rubber	■ ■ ■	52	XS
95202BN02KK	-	leather/nylon/rubber	■ ■ ■	54	S
95202BN03KK	-	leather/nylon/rubber	■ ■ ■	57	M
95202BN04KK	-	leather/nylon/rubber	■ ■ ■	63	L
95202BN05KK	-	leather/nylon/rubber	■ ■ ■	66	XL
95202BN06KK	-	leather/nylon/rubber	■ ■ ■	69	XXL

CONNECTORS AND QUICKDRAWS CONNETTORI E RINVII

4

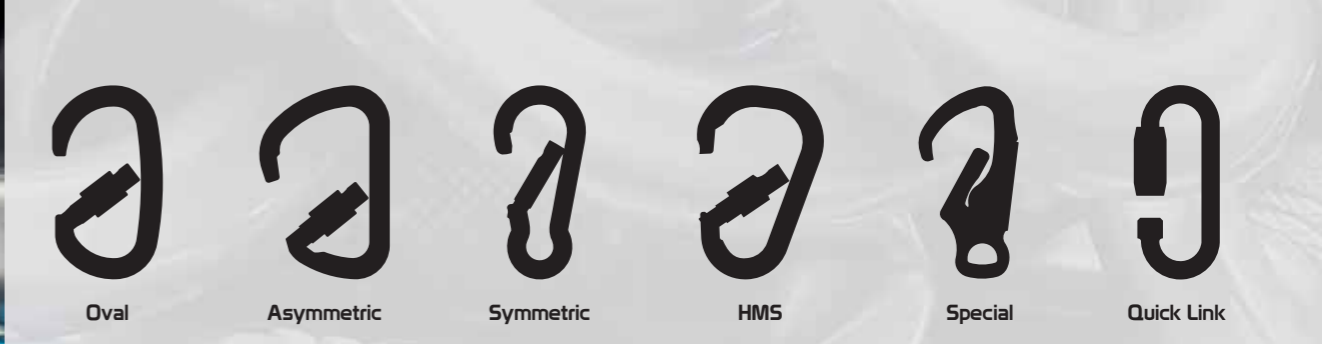

Materials / Materiali utilizzati

ALU ALLOY / LEGA D'ALLUMINIO

- Best weight/load ratio. Anodized finishing for the best resistance in aggressive environments. Attractive look, colored finishing.
- Miglior rapporto peso/carico. Finitura tramite anodizzazione per la migliore resistenza in ambienti aggressivi. Aspetto accattivante, finitura colorata.

CARBON STEEL / ACCIAIO AL CARBONIO

- For heavy loads. Special black burnished finishing for better visibility of the laser markings and a more attractive look.
- Per utilizzi gravosi e di carico pesante. Speciale finitura brunitura nera per una migliore visibilità della marcatura laser e un aspetto accattivante.

STAINLESS STEEL / ACCIAIO INOX

- High quality AISI 316L steel. Best corrosion resistance. Perfect for marine environments and food industry. Available on demand the burnished finishing "BB".
- Acciaio di alta qualità AISI 316L. Migliore resistenza alla corrosione. Perfetto per ambienti marini e industria alimentare. Disponibile su richiesta la finitura brunita "BB".



Shape / Forma

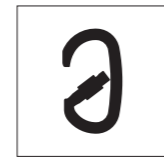

OVAL / OVALE

- Versatile shape that shares the load between the spine and the gate.
- Forma versatile che distribuisce uniformemente il carico tra il corpo e la leva.



ASYMMETRIC / ASIMMETRICO

- Designed to orient the load in a predetermined direction on the connector's body.
- Connettore a chiusura automatica destinato ad assicurare il carico in una predeterminata direzione.



SYMMETRIC / SIMMETRICO

- Smooth regular curves are gentle on equipment and allow easy repositioning of loads.
- Le curve regolari e morbide sono delicate sull'attrezzatura e consentono un facile riposizionamento dei carichi



HMS

- HMS is an abbreviation of the German term Halbmastwurf-Sicherung, primarily intended for use when giving a dynamic belay using an "italian hitch" knot.
- Connettore a chiusura automatica, HMS è l'acronimo del termine tedesco Halbmastwurf-Sicherung, destinato principalmente ad una assicurazione dinamica usando un nodo "mezzo barcaiole".



SPECIAL / SPECIALE

- Connectors with complex shapes for a particular purpose; can in some cases be connected directly to a specific anchor type.
- Connettore a chiusura automatica con forme complesse destinato a utilizzi particolari; può in certi casi essere collegato direttamente ad un tipo di ancoraggio specifico.



QUICK LINK / MAGLIA RAPIDA

- Connector with a manual closing system, intended for those applications that do not require frequent removal.
- Connettore a chiusura manuale a vite destinato a quegli impieghi dove non è richiesta la rimozione frequente.



All our connectors are tested piece by piece.
Tutti i nostri connettori sono testati pezzo per pezzo.



Watch the video
Guarda il video

Sleeves / Ghiere di sicurezza

SCREW / VITE

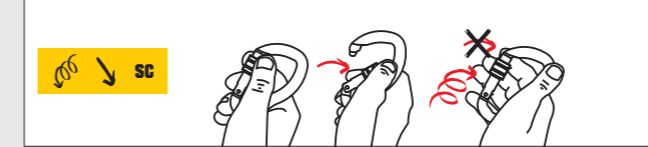

- This sleeve is commonly used for mountaineering. The Kong version is popular due to its quick operation.
- Questa ghiera è quella comunemente utilizzata per l'alpinismo. La versione Kong è apprezzata perchè si aziona rapidamente.

TWIST LOCK



- (2 movements) - The twist-lock sleeve is optimal for safety and convenience. For this reason it is preferred in rescue operations and for industrial use. Available in an ANSI certified version (United States standard).
- (2 movimenti) - La ghiera twist-lock è ottimale per sicurezza e praticità. Per questo motivo è preferita nelle operazioni di soccorso e per usi industriali. Disponibile in versione omologata ANSI (normativa USA).

AUTO BLOCK



- (3 movements) - This sleeve requires three movements to open, and is therefore intended to fulfill the most difficult tasks. Available in an ANSI certified version (United States standard).
- (3 movimenti) - Questa ghiera richiede tre movimenti per l'apertura e quindi è destinata ad assolvere i compiti più ardui. Disponibile in versione omologata ANSI (normativa USA).

DOUBLE GATE



- This gate is preferred for applications that require frequent openings, as on life lines, because it is easy and secure.
- Questa ghiera è preferita per un uso ripetuto, come avviene sulle linee vita, perchè viene azionata in modo rapido e semplice.

EXPRESS



- This gate is preferred for applications that require frequent openings, as on life lines, because it is easy and secure.
- Questa ghiera è preferita per un uso ripetuto, come avviene sulle linee vita, perchè viene azionata in modo rapido e semplice.

General Safety Remarks

Warning: The maximum tolerated load marked on the connectors is very close to the breaking point. Connectors supporting this stress will be permanently deformed and absolutely must be replaced. See the following pictures for connector and sleeve testing.

Attenzione: sui connettori è marcato il carico massimo garantito, molto vicino a quello di rottura. Un connettore sottoposto a tale carico si deforma permanentemente e deve essere assolutamente sostituito. I connettori e le ghiere vengono testati come riportato nelle seguenti illustrazioni.

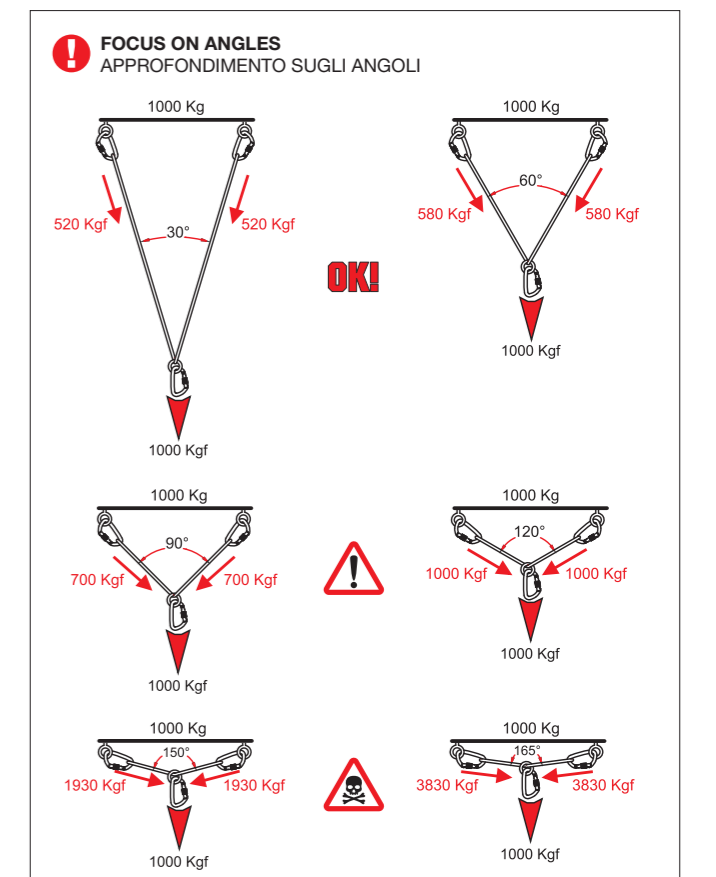
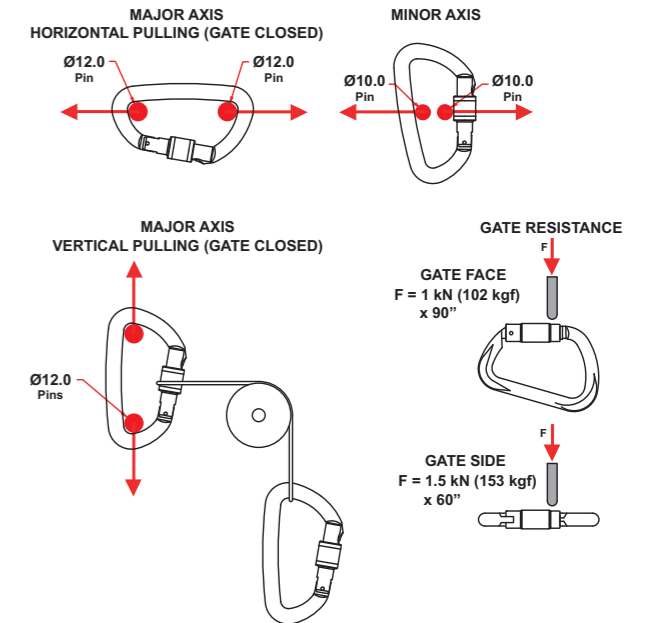

i-CONNECTOR

NEW

- i-CONNECTOR, the first connector in the world with an integrated NFC chip.
- No compromise on product performance and a technological leap that incredibly improves the management of Personal Protective Equipment.
- This is the first and only connector in the world with an integrated NFC microchip, which allows to have always at hand the history of the device, from the information related to the production up to the results of the periodic inspections mandatory for the use in a professional environment.
- The NFC technology does not require complex systems and expensive readers to access the information contained in the microchip, just a common smartphone or PC.
- i-CONNECTOR, as we have called them, are a family of connectors that at the moment includes some versions of the Ovalone model, but the number of variants is going to grow.
- i-CONNECTOR, il primo connettore al mondo dotato di chip NFC integrato.
- Nessun compromesso sulle performance del prodotto e un salto tecnologico che migliora incredibilmente la gestione dei Dispositivi di Protezione Individuale.
- Si tratta del primo e unico connettore al mondo con microchip NFC integrato, che permette di avere sempre a portata di mano la **storia del dispositivo**, dalle informazioni relative alla produzione fino agli esiti delle ispezioni periodiche obbligatorie per l'utilizzo in ambito professionale.
- La tecnologia NFC non richiede sistemi complessi e lettori costosi per accedere alle informazioni contenute nel microchip, è sufficiente un comune **smartphone** o un **PC**.
- i-CONNECTOR, come li abbiamo chiamati, sono una famiglia di connettori che al momento include alcune versioni del modello **Ovalone**, ma il numero di varianti è destinato a crescere.



NFC Ready

What are the benefits? Quali sono i vantaggi?

- It is a technology available to everyone
- It can be read with a simple smartphone or PC
- It does not require the use of expensive readers
- It has infinite fields of application
- Compatible with any software
- It allows a traceability of the device to a error-proof
- Combines the traditional serial number marking with a digital and long-lasting system
- Immediate reading of the serial number without transcription errors
- Technology already available on most of our products
- È una tecnologia disponibile a tutti
- È leggibile con un semplice smartphone o pc
- Non richiede l'utilizzo di costosi lettori
- Ha infiniti campi di applicazione
- È compatibile con qualunque software
- Permette una tracciabilità del dispositivo a prova di errore
- Affianca la tradizionale marcatura del numero seriale con un sistema digitale e a lunga durata
- Lettura del seriale immediata e senza errori di trascrizione
- È una tecnologia già disponibile su gran parte dei nostri prodotti

What is it for? A cosa serve?

- Periodic inspections
- Device assignment management
- Management of loading and unloading of the warehouse
- Adventure Parks access management
- Monitoring the number of uses of the device
- Insertion of personal information
- Your imagination is the limit...
- Ispezioni periodiche
- Gestione assegnazione del dispositivo
- Gestione di carico e scarico del magazzino
- Gestione degli accessi ad un parco avventura
- Monitoraggio del numero di utilizzi del dispositivo
- Inserimento di informazioni personali
- Il limite è dato dalla tua fantasia...



See the range of products equipped with chips
Guarda la gamma di prodotti dotati di chip



Watch the promotional video
Guarda il video promozionale



Watch the tutorial with usage tips
Guarda il tutorial con i consigli di utilizzo



Exteryo website
Sito web Exteryo

KEYLOCK

Did you know that Kong was the first company to produce KeyLock connectors?

Lo sapevate che Kong è stata la prima azienda a produrre connettori KeyLock?



KEY LOCK PATENT SYSTEM SISTEMA BREVETTATO KEY LOCK

This revolutionary locking system patented by Kong in 1985 takes its name from the peculiar shape of the connection between the gate and the body of the connector that looks like a door keyhole. The real novelty of this patent is that there is absolutely no need for any teeth on the body of the carabiner or on the gate, now completely cylindrical.

Now there are no longer any points where the rope or web could get snagged while inserting and removing them. All the sharp edges left over from grinding the carabiner and gate have also been eliminated, as it is no longer necessary.

Questo rivoluzionario sistema di chiusura brevettato da Kong nel 1985 trae il suo nome dalla particolare forma dell'incastro tra la leva ed il corpo del connettore, che ricorda la serratura di una porta. La novità del brevetto è di aver definitivamente eliminato qualsiasi dente di tenuta sia sul corpo del connettore che sulla leva ora completamente cilindrica. Non esiste più alcun punto di possibile impiglio della corda o della fettuccia durante l'inserimento e lo sgancio. Sono stati eliminati pure tutti i bordi taglienti delle fresature del corpo del connettore e della leva, ora non più necessarie.



VERY OLD



OUT OF DATE



TRADITIONAL

OVAL ALU KEYLOCK

- Oval aluminum carabiner with a rounded bar, recommended for use with mobile devices (pulleys, rope clamps, fall arresters, etc.).
- Available with a straight gate or screw sleeve, making it also suitable for professional applications.
- The Keylock system prevents any accidental catching on the rope or anchor point.
- Also available in carbon steel version, recommended for caving
- Connettore ovale in alluminio con corpo a sezione circolare che lo rende consigliato per l'utilizzo con dispositivi mobili (carrucole, bloccanti, anticaduta...).
- Disponibile nelle versioni a leva dritta e con ghiera a vite che lo rende utilizzabile anche per applicazioni professionali
- Sistema keylock che evita qualunque impiglio accidentale della corda o nel punto di ancoraggio.
- Disponibile in acciaio al carbonio, versione apprezzata degli speleo



ALU ALLOY
straight gate

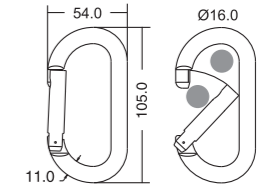

ALU ALLOY
screw sleeve

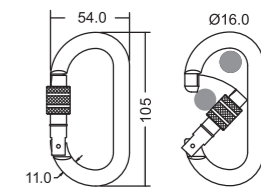

#	Standards	Color	kN	kN	kN	g
Alu alloy straight gate						
730L00PP0KK	• EN 12275	■ ■	22	7	7	60
730L00BD0KK	• EN 12275	■ ■	22	7	7	60
730L00RN0KK	• EN 12275	■ ■	22	7	7	60
Alu alloy screw sleeve						
730LA0ON0KK	• EN 12275 EN 362/B	■ ■ ■	22	7	7	65
730LA0PPP0KK	• EN 12275 EN 362/B	■ ■ ■	22	7	7	65
730BPP3A1KK	• EN 12275 EN 362/B	■ ■ ■	22	7	7	65
730LA0RPP0KK	• EN 12275 EN 362/B	■ ■ ■	22	7	7	65

OVALONE KEYLOCK

- Oval aluminum carabiner with a large opening. The wide symmetrical shape, greater than a classic oval, positions well on mobile devices allowing their correct operation, even if not perfectly aligned with the connector.
- Available in straight gate, screw sleeve, Auto Block and Twist Lock models.
- The Keylock system prevents any accidental catching on the rope or anchor point.

- Connettore ovale in alluminio con grande apertura della leva. L'ampia forma simmetrica, maggiore rispetto a quella di un ovale classico, permette un miglior posizionamento sui dispositivi mobili e il loro corretto funzionamento anche se non perfettamente in asse con il connettore.
- Disponibile nelle versioni a leva dritta, a ghiera a vite e con le ghiere automatiche Auto Block e Twist Lock.
- Sistema keylock che evita qualunque impiglio accidentale della corda o nel punto di ancoraggio.

ALU ALLOY straight gate

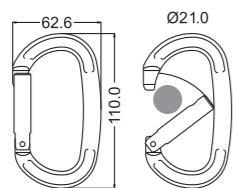

ALU ALLOY auto block twist lock

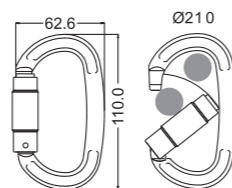

ALU ALLOY screw sleeve

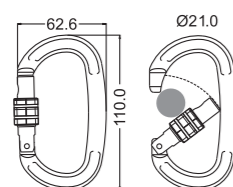

#	Standards	Color	KN	KN	KN	g
Alu alloy straight gate						
712L00PP0KK	EN 12275/B	Grey	26	12	8	68
Alu alloy screw sleeve						
712LA0ONOKK	EN 362/B EN 12275/B	Black/Orange	26	12	8	72
712LA0PPPKK	EN 362/B EN 12275/B	Grey	26	12	8	72
712LA0RNP0KK	EN 362/B EN 12275/B	Red/Black/White	26	12	8	72

#	Standards	Color	KN	KN	KN	g
Alu alloy auto block						
712LM0OPNKK	EN 362/B EN 12275/B	Orange/Black/White	26	9	-	79
712LM0RPPPKK	EN 362/B EN 12275/B	Red/Black/White	26	9	-	79
712LM0PPPKK	EN 362/B EN 12275	Grey	26	9	-	79
Alu alloy twist lock						
712LG0OPNKK	EN 362/B EN 12275/B	Orange/Black/White	26	9	-	79
712LG0RPPPKK	EN 362/B EN 12275/B	Red/Black/White	26	9	-	79
712LG0PPPKK	EN 362/B EN 12275/B	Grey	26	9	-	79

I-OVALONE ALU KEYLOCK

- NEW**
- New connector equipped with NFC chip that brings the history of your device always at your fingertips. No expensive readers required. Readable with a common smartphone or PC.
- This solution provides an easier and faster periodic inspection process, avoiding dangerous mistakes made during the serial number transcription.
- Compatible with any inspection software.
- Patented system.
- Standard version, without chip, also available
- Oval aluminum carabiner with large opening.

- Key features:**
- System Keylock
 - High quality product entirely developed and manufactured in Italy
 - Tested piece by piece
 - Also available with the **new ECO finish** obtained by totally removing heavy chemical treatments. **Think green, preserve the planet!**
 - Innovativo connettore dotato di microchip NFC che permette di avere sempre a portata di mano la storia del dispositivo, senza l'ausilio di lettori costosi, è sufficiente un comune smartphone o pc.
 - Questa soluzione facilita e velocizza la fase di ispezione periodica ed evita pericolosi errori di trascrizione del numero seriale.
 - Compatibile con tutti i software d'ispezione.
 - Sistema brevettato.
 - Disponibile anche in versione standard senza chip.
 - Moschettone ovale in alluminio con grande apertura della leva.

- Caratteristiche chiave:**
- Sistema Keylock
 - Prodotto di alta qualità completamente sviluppato e realizzato in Italia
 - Testato pezzo per pezzo
 - Disponibile anche nella **nuova finitura ECO** ottenuta eliminando tutti i trattamenti chimici pesanti. **Think green, preserve the planet!**



NEW ECO FINISH
NUOVA FINITURA ECO

ALU ALLOY auto block

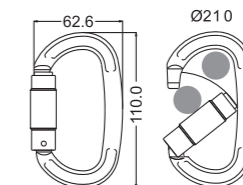

ALU ALLOY twist lock

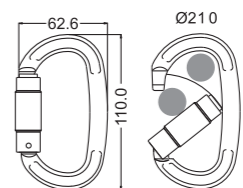

#	Standards	Color	KN	KN	KN	g
Alu alloy auto block						
712LM1FFF0KK	EN 362/B EN 12275/B	Black/Black/Black	26	9	-	76
712LM1LLL0KK	EN 362/B EN 12275/B	Grey	26	9	-	76
712LM1NNN0KK	EN 362/B EN 12275	Black	26	9	-	76
Alu alloy twist lock						
712LG1FFF0KK	EN 362/B EN 12275/B	Black/Black/Black	26	9	-	76
712LG1LLL0KK	EN 362/B EN 12275/B	Grey	26	9	-	76
712LG1NNN0KK	EN 362/B EN 12275/B	Black	26	9	-	76

ARGON

- Connector dedicated to those looking for maximum lightness and small dimensions. Designed for sport climbing and for assembling light quickdraws. Available with a straight gate and Keylock system that allows easy clipping, or with a wire gate for extreme lightness, or with a screw sleeve making it one of the smallest locking connectors on the market.
- Connettore dedicato a chi cerca il massimo della leggerezza e il minimo ingombro. Progettato per l'arrampicata sportiva e l'utilizzo su rinvio. Disponibile con leva dritta e sistema Keylock che permette un facile moschettonaggio allo spit, in versione con leva a filo ultraleggera e con ghiera a vite che lo rende uno dei più piccoli connettori da sosta presenti sul mercato.

ARGON K KEYLOCK
LIGHT ALLOY

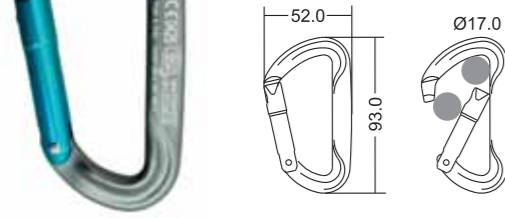

ARGON F
LIGHT ALLOY

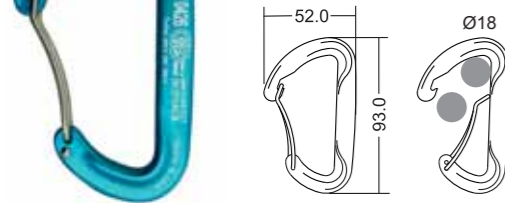

ARGON S KEYLOCK
LIGHT ALLOY

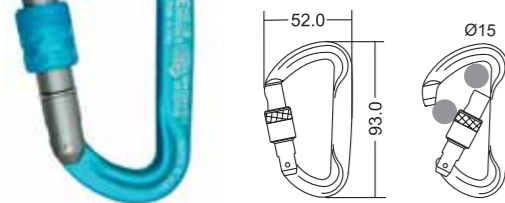

#	Standards	Color	kN	kN	kN	g
ARGON K light alloy						
719H00DB0KK	• EN 12275	■ ■	22	9	7	36
ARGON F light alloy						
719H30B00KK	• EN 12275	■ ■	21	8	7	31
719H30D00KK	• EN 12275	■ ■	21	8	7	31
ARGON S light alloy						
719HA0DBBKK	• EN 12275 EN 362/B	■ ■ ■	22	9	7	43

ARGON R

- Argon R is the doped-up version of the smaller Argon. The special curved shape provides a secure grip and fast clipping. The contact surfaces are wider to reduce wear and lengthen the life of the carabiner. The gate opening has been increased. Designed specifically as a rope connector for Argon quickdraws.
- Argon R è la versione anabolizzata del più compatto Argon. La speciale forma curva permette una sicura presa della mano e un rapido moschettonaggio della corda. Le superfici di contatto sono più larghe per ridurre l'usura e il passaggio della corda è stato aumentato. Studiato appositamente come connettore da corda per i rinvii Argon.

ARGON RK KEYLOCK
LIGHT ALLOY

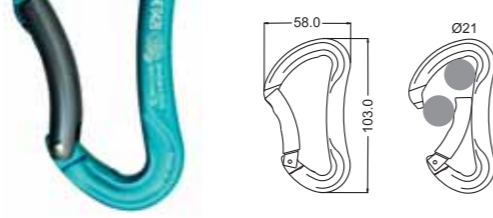

ARGON RF
LIGHT ALLOY

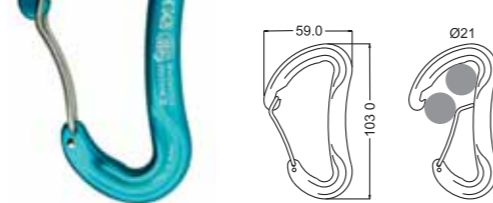

#	Standards	Color	kN	kN	kN	g
ARGON RK light alloy						
729I10BD0KK	• EN 12275	■ ■	22	10	10	48
ARGON RF light alloy						
729I30BP0KK	• EN 12275	■ ■	23	9	10	39

ERGO

- Compact and lightweight connector, with an ergonomic shape and high tensile strength.
- Available with a straight or bent gate, with a screw, express, auto block or twist lock sleeve and in the special double gate version with a durable wire gate.

ALU ALLOY KEYLOCK
straight gate

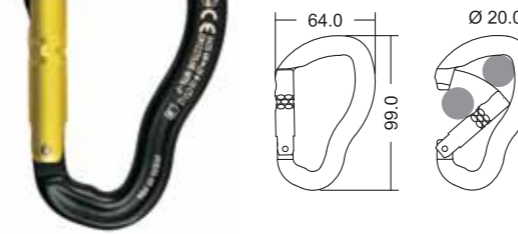

ALU ALLOY KEYLOCK
bent gate

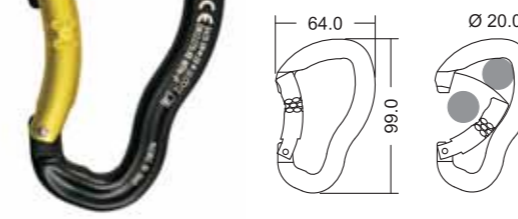

ALU ALLOY KEYLOCK
screw sleeve

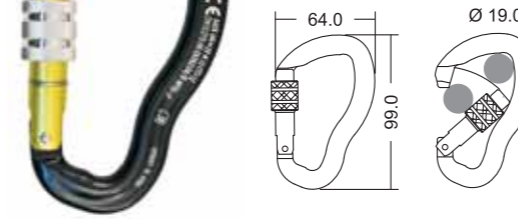

#	Standards	Color	kN	kN	kN	g
Alu alloy straight gate						
783I00PP0KK	• EN 12275	■ ■	27	10	9	55
783I00NC0KK	• EN 12275	■ ■	27	10	9	55
783I00NN0KK	• EN 12275	■ ■	27	10	9	55
Alu alloy bent gate						
783I0PP0KK	• EN 12275	■ ■	27	10	9	55
783I0NC0KK	• EN 12275	■ ■	27	10	9	55
783I0NN0KK	• EN 12275	■ ■	27	10	9	55
Alu alloy screw sleeve						
783IA0PPPKK	• EN 12275 EN 362/B	■ ■ ■	27	10	9	58
783IA0NCPKK	• EN 12275 EN 362/B	■ ■ ■	27	10	9	58
783IA0NNNKK	• EN 12275 EN 362/B	■ ■ ■	27	10	9	58

- Compatto e leggero, dalla forma ergonomica e con un elevato carico di rottura.
- Disponibile con leva dritta o curva, ghiera a vite, express, autoblock, twistlock e nella speciale versione double gate con resistente leva a filo.

ALU ALLOY KEYLOCK
express sleeve

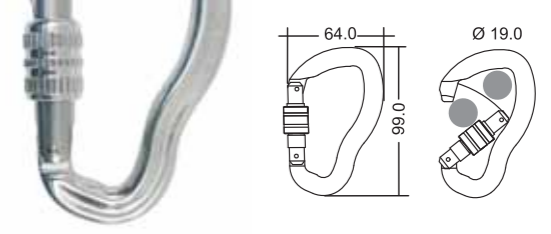

ALU ALLOY KEYLOCK
auto block
twist lock

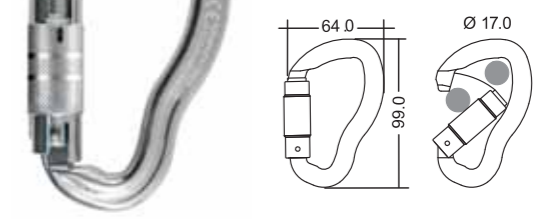

ALU ALLOY
double gate

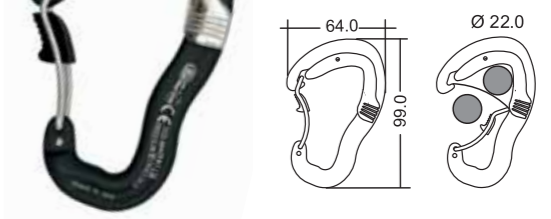

#	Standards	Color	kN	kN	kN	g
Alu alloy express sleeve						
783IU0PPPKK	• EN 12275 EN 362/B	■ ■ ■	27	10	-	59
Alu alloy auto block						
783IM0PPPKK	• EN 12275 EN 362/B	■ ■ ■	27	7	-	65
Alu alloy twist lock						
783IG0PPPKK	• EN 12275 EN 362/B	■ ■ ■	27	7	-	65
Alu alloy double gate						
783IX0NPPKK	• EN 12275/B EN 362/B	■ ■ ■	27	7	-	83

TRAPPER

- Aluminum alloy carabiner available with a straight gate, bent gate or screw sleeve, and fitted with the Keylock system. Designed for use in quickdraws. The D shape transfers the majority of the load onto the main axis of the carabiner.
- Connettore da rinvio in lega d'alluminio disponibile con leva dritta, curva o ghiera a vite, dotato di sistema keylock. Progettato per l'arrampicata sportiva e l'utilizzo su rinvio. La forma a D trasferisce la maggioranza del carico sull'asse principale del moschettone.

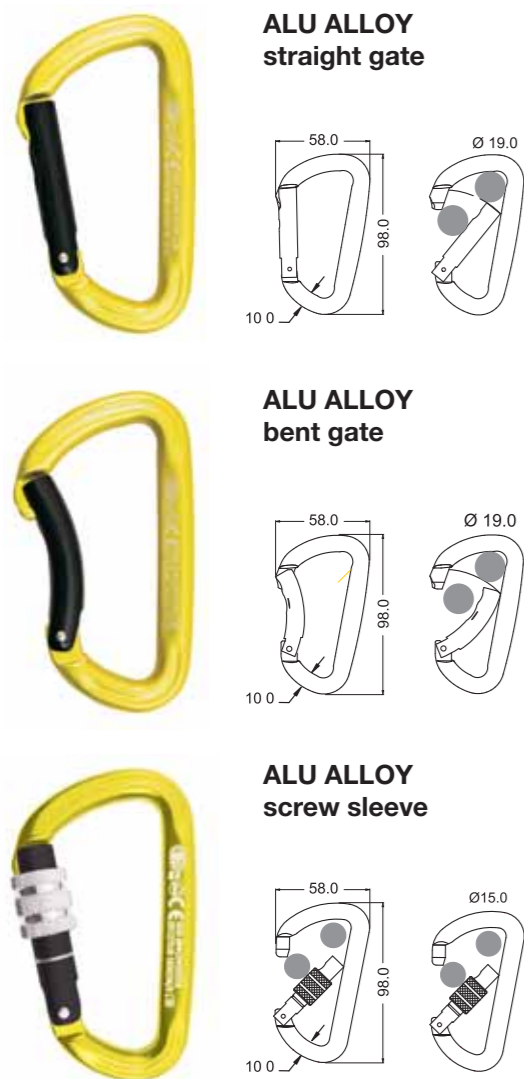

#	UMMA	Standards	Color	KN	KN	KN	g
Alu alloy straight gate							
789100PP0KK	•	EN 12275		23	10	8	55
789100CN0KK	•	EN 12275		23	10	8	55
Alu alloy bent gate							
789110PP0KK	•	EN 12275		23	10	8	52
789110CN0KK	•	EN 12275		23	10	8	52
Alu alloy screw sleeve							
7891A0CNP0KK	•	EN 12275 EN 362/B		23	10	8	55

GUIDE

- Heavy load aluminum alloy connector.
- The generous size and wide gate opening make it practical and liked by both beginners and professionals.
- Connettore in lega d'alluminio ad alto carico.
- Le dimensioni generose e l'ampia apertura della leva lo rendono un prodotto pratico e trasversale apprezzato sia dai principianti che dai professionisti.

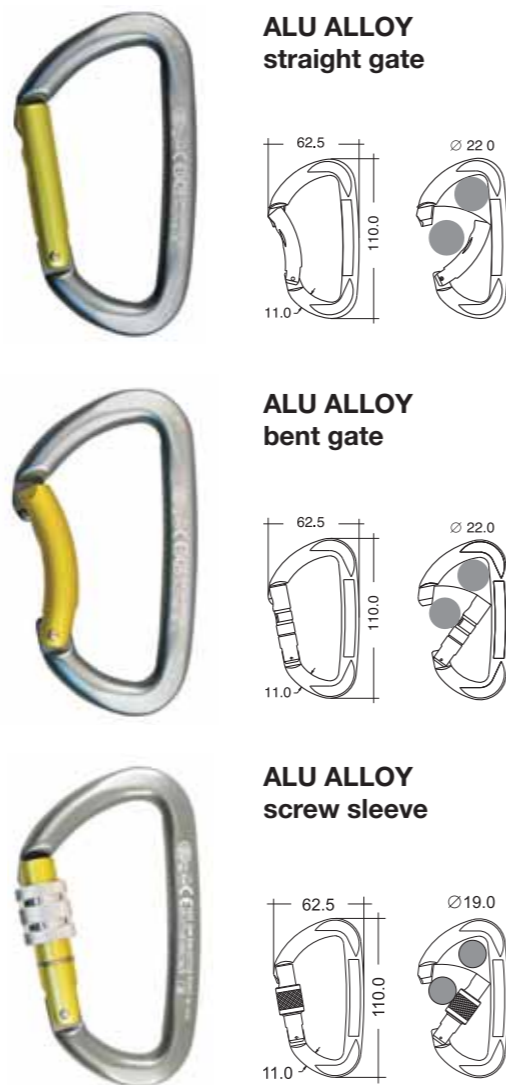

#	UMMA	Standards	Color	KN	KN	KN	g
Alu alloy straight gate							
733L00PP0KK	•	EN 12275		30	10	10	65
Alu alloy bent gate							
733L10PP0KK	•	EN 12275		30	10	10	65
733L10DC0KK	•	EN 12275		30	10	10	65
Alu alloy screw sleeve							
733LA0PPP0KK	•	EN 12275/B EN 362/B		30	10	10	70
733LA0DCP0KK	•	EN 12275/B EN 362/B		30	10	10	70
733LA0RNP0KK	•	EN 12275/B EN 362/B		30	10	10	70

FERRATA

- Aluminum alloy connector available with a screw, auto block or twist lock sleeve.
- Its special shape provides a large opening (up to 27 mm) and an excellent grip.
- Normally used on longe or klettersteig sets.
- Connettore in alluminio disponibile con ghiera a vite, autoblock e twistlock.
- La forma particolare garantisce una grande apertura (27 mm) e un'ottima impugnatura.
- Normalmente utilizzato su longe o set ferrata.



#	UMMA	Standards	Color	KN	KN	KN	g
Alu alloy express sleeve							
778MU0PPP0KK	•	EN 12275/K EN 362/B		30	10	12	90
778MU0RPP0KK	•	EN 12275/K EN 362/B		30	10	12	90
Alu alloy screw sleeve							
778MA0PPP0KK	•	EN 12275 EN 362/B		30	10	12	90
Alu alloy auto block							
778MM0PPP0KK	•	EN 12275/K EN 362/B		30	8	12	95
778MM0RPP0KK	•	EN 12275/K EN 362/B		30	8	12	95
Alu alloy twist lock							
778MG0PPP0KK	•	EN 12275/K EN 362/B		30	8	12	95
778MG0RPP0KK	•	EN 12275/K EN 362/B		30	8	12	95

PADDLE

- Initially designed for attaching the paddle of a kayak, this connector has found various applications due to its wide opening of up to 33.5 mm!
- Concepito inizialmente per agganciare il manico della pagaia da kayak, il Paddle ha trovato numerose applicazioni grazie alla notevole apertura di ben 33,5 mm!



#	UMMA	Standards	Color	KN	KN	KN	g
PADDLE alu alloy bent gate							
765M10PP0KK	•	EN 12275		22	-	7	80
765M10BD0KK	•	EN 12275		22	-	7	80
765M10RC0KK	•	EN 12275		22	-	7	80
PADDLE BAR alu alloy bent gate							
765M1KPP0KK	•	EN 12275		22	-	7	81
765M1KBD0KK	•	EN 12275		22	-	7	81
765M1KRC0KK	•	EN 12275		22	-	7	81
PADDLE WIRE alu alloy bent gate							
765M30PP0KK	•	EN 12275		22	8	7	71
765M30BP0KK	•	EN 12275		22	8	7	71
765M30RP0KK	•	EN 12275		22	8	7	71

INDOOR

- Designed for use on fixed quickdraws in indoor gyms. The curved gate ensures fast clipping. The use of stainless steel reduces wear over time.
- Progettato per l'utilizzo sui rinvii fissi nelle palestre indoor. La forma curva della leva garantisce un rapido moschettonaggio della corda. L'utilizzo dell'acciaio inox riduce notevolmente l'usura nel tempo.



STAINLESS STEEL bent gate

LARGE MULTIUSE

- Heavy load connector that combines a wide opening with compact size. Locking versions are recommended for use with manually operated descenders such as the Otto or Oka.
- Connettore ad alto carico che combina grande apertura e dimensioni compatte. Le versioni a ghiera sono consigliate per l'utilizzo con discensori a comando manuale quali l'Otto o l'Oka.

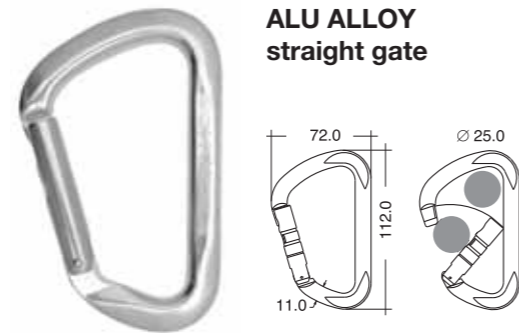

ALU ALLOY straight gate

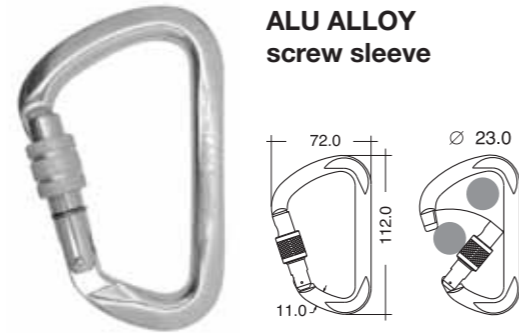

ALU ALLOY screw sleeve

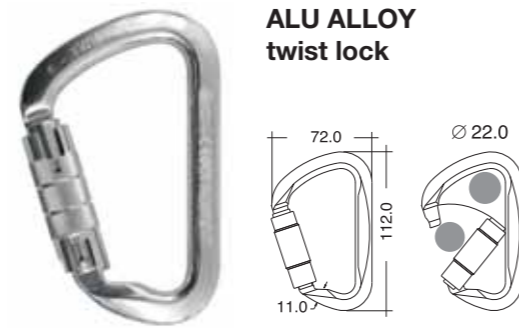

ALU ALLOY twist lock

#	Standards	Color	KN	KN	KN	g
Stainless steel bent gate						
524110PROKK	EN 12275		25	10	8	125

#	Standards	Color	KN	KN	KN	g
Alu alloy straight gate						
737L00PP0KK	EN 12275/B		27	9	9	65
737L00DB0KK	EN 12275/B		27	9	9	65
Alu alloy screw sleeve						
737LA0PPPKK	EN 12275/B/H EN 362/B		27	9	9	73
737LA0QNPCK	EN 12275/B/H EN 362/B		27	9	9	73
737LA0RNPCK	EN 12275/B/H EN 362/B		27	9	9	73
Alu alloy twist lock						
737LG0PPPKK	EN 12275/B/H EN 362/B		27	8	9	78
737LG0DPQKK	EN 12275/B/H EN 362/B		27	8	9	78
737LG0NPNCK	EN 12275/B/H EN 362/B		27	8	9	78
737LG0QPPCK	EN 12275/B/H EN 362/B		27	8	9	78
737RPP3P1KK	EN 12275/B/H EN 362/B		27	8	9	78

X-LARGE ALU

- The size and shape of this carabiner make it suitable for connecting different ropes and tapes, for organizing an anchor point, for belaying, or for descending with a single rope or half ropes.
- La dimensione e la forma di questo moschettono sono adatte per collegare diverse corde e fettucce, organizzare la sosta, assicurare o scendere in doppia con un mezzo barcaiolo, su corda singola o mezza corda.



ALU ALLOY straight gate



ALU ALLOY screw sleeve



ALU ALLOY auto block twist lock

#	Standards	Color	KN	KN	KN	g
Alu alloy straight gate						
711M00PP0KK	EN 12275		30	8	10	85
Alu alloy screw sleeve						
711MA0ONOKK	EN 12275 EN 362/B		30	8	10	90
711MA0PPPKK	EN 12275 EN 362/B		30	8	10	90
711MA0RDPCK	EN 12275 EN 362/B		30	8	10	90
Alu alloy auto block						
711MM0OPNCK	EN 12275/B EN 362/B		30	8	-	95
711MM0PPPKK	EN 12275 EN 362/B		30	8	-	95
711MM0RPPCK	EN 12275 EN 362/B		30	8	-	95
Alu alloy twist lock						
711MG0OPNCK	EN 12275 EN 362/B		30	8	-	95
711MG0RPPCK	EN 12275 EN 362/B		30	8	-	95

MINI D

- The smallest aluminum carabiner with a screw sleeve in our production.
- To be used for accessories, and ideal for ice axe lanyards.
- Available in a straight gate version.
- Warning! Not suitable for human support.
- Il più piccolo moschettono in alluminio con ghiera a vite della nostra produzione.
- Da utilizzare come porta accessori, ideale per le longe delle piccozze.
- Disponibile anche in versione senza ghiera.
- Attenzione! Non adatto al supporto umano.

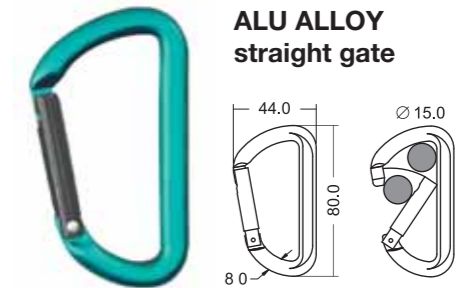

ALU ALLOY straight gate



ALU ALLOY screw sleeve

Warning! Not suitable for human support.
Attenzione! Non adatto al supporto umano.

#	Standards	Color	KN	KN	KN	g
MINI D						
751E00VN0KK	-		6	-	-	26
751E00ON0KK	-		6	-	-	26
751E00PP0KK	-		6	-	-	26
751E00NN0KK	-		6	-	-	26
751E00BD0KK	-		6	-	-	26
751E00RN0KK	-		6	-	-	26
751E00GN0KK	-		6	-	-	26
MINI D Screw						
751EA0NNNCK	-		600 kg	-	-	32
751EA0PPPKK	-		600 kg	-	-	32

H.M.S. CLASSIC

- The classic wide pear shape makes it suitable for belaying with a clove hitch. It can be used with all anchoring and belaying systems. The checkering on the sleeves provides better grip when wearing gloves.
- La classica forma a base larga HMS a pera lo rende adatto per assicurazioni con nodo barcaiolo o mezzo barcaiolo. Possibilità di utilizzo con tutti i sistemi di ancoraggio e assicurazione, sia in sosta che collegati all'imbraco. La zigrinatura della ghiera favorisce l'utilizzo anche con i guanti.

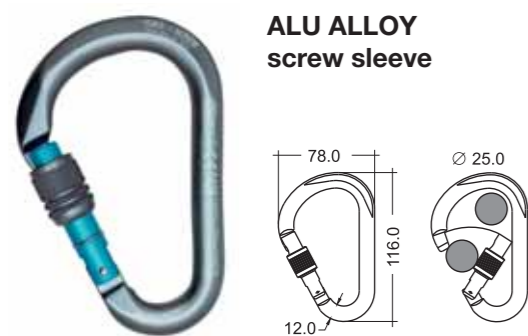

ALU ALLOY
screw sleeve



ALU ALLOY
auto block
twist lock

#	Standards	Color	KN	KN	KN	g
Alu alloy screw sleeve						
786MA0ONOKK	• EN 12275 EN 362/B		22	8	6	88
786MA0PPPKK	• EN 12275 EN 362/B		22	8	6	88
786MA0DBDKK	• EN 12275 EN 362/B		22	8	6	88
786MA0RNPCK	• EN 12275 EN 362/B		22	8	6	88
Alu alloy auto block						
786MM0OPNKK	• EN 12275 EN 362/B		22	8	-	95
786MM0PPPKK	• EN 12275 EN 362/B		22	8	-	95
786MM0RPPCK	• EN 12275 EN 362/B		22	8	-	95
786MM0DPBCK	• EN 12275 EN 362/B		22	8	-	95
Alu alloy twist lock						
786MM0OPNKK	• EN 12275 EN 362/B		22	8	-	95
786MM0PPPKK	• EN 12275 EN 362/B		22	8	-	95
786MM0RPPCK	• EN 12275 EN 362/B		22	8	-	95
786MM0DPBCK	• EN 12275 EN 362/B		22	8	-	95

H.M.S. NAPIK

- HMS connector of modern conception, lighter and more compact than the traditional HMS yet with a higher tensile strength.
- Connettore HMS di concezione moderna, più compatto e leggero del tradizionale connettore HMS e con un carico di rottura superiore.



ALU ALLOY
screw sleeve



ALU ALLOY
auto block
twist lock

#	Standards	Color	KN	KN	KN	g
Alu alloy screw sleeve						
787MA0ONOKK	• EN 12275 EN 362/B		23	10	6	80
787MA0PPPKK	• EN 12275 EN 362/B		23	10	6	80
787MA0ONOKK	• EN 12275 EN 362/B		23	10	6	80
787MA0DBDKK	• EN 12275 EN 362/B		23	10	6	80
Alu alloy auto block						
787MM0OPNKK	• EN 12275 EN 362/B		23	8	-	91
787MM0RPPCK	• EN 12275 EN 362/B		23	8	-	91
787MM0DBDKK	• EN 12275 EN 362/B		23	8	-	91
Alu alloy twist lock						
787MG0OPNKK	• EN 12275 EN 362/B		23	8	-	85
787MG0PPPKK	• EN 12275 EN 362/B		23	8	-	85
787MG0RPPCK	• EN 12275 EN 362/B		23	8	-	85
787MG0DBDKK	• EN 12275 EN 362/B		23	8	-	85

TANGO 360

- NEW**
- Tango 360 is the integration of our Tango connector with a highly efficient swivel and overload indicator that activates when stressed with a load between 200 and 300kg.
- It is a directional connector, designed to avoid twisting of ropes, lanyards and metal cables.
- The Double Gate safety system makes it easy to use and reduces the risk of accidental opening.
- The Keylock system avoids accidental snags during maneuvers.
- Tango 360 è l'integrazione del nostro connettore Tango con un girello ad alta efficienza e indicatore di sovraccarico che si attiva quando sollecitato con un carico tra 200 e 300kg.
- Si tratta di un connettore direzionale, concepito per evitare l'attorcigliamento di corde, lanyard e cavi metallici.
- La chiusura della leva Double Gate lo rende facile da usare e riduce il rischio di aperture accidentali.
- Chiusura Keylock che evita impigli accidentali durante le manovre.



ALU ALLOY
double gate



#	Standards	Color	KN	KN	KN	g
TANGO						
7150XNNNNKK	• EN 12275/K EN 362/T		30	10	15	205

TANGO

- Hot forged aluminum carabiner with a double gate.
- Ideal for positioning lanyards and klettersteig sets.
- Connettore in alluminio forgiato a caldo con doppia leva di sicurezza.
- Ideale per realizzare longe di posizionamento e set ferrata.

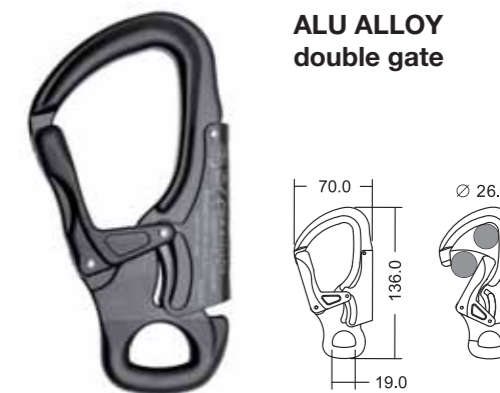

ALU ALLOY
double gate

#	Standards	Color	KN	KN	KN	g
TANGO						
7150X0NNNKK	• EN 12275/K EN 362/T		33	10	15	130
7150X0QPPKK	• EN 12275/K EN 362/T		33	10	15	130
7150X0RPPCK	• EN 12275/K EN 362/T		33	10	15	130
7150X0BNNKK	• EN 12275/K EN 362/T		33	10	15	130
7150X0ONNKK	• EN 12275/K EN 362/T		33	10	15	130

KONG CLEANER AND PROTECTIVE OIL

- Oil lubricant and protectant for moving parts.
- Recommended for the maintenance of carabiners, pulleys, gear with mobile levers.
- Pack: 50 ml
- Olio lubrificante e protettivo per parti in movimento.
- Consigliato per la manutenzione di moschettoni, carrucole, attrezzi con leve mobili.
- Confezione da 50 ml



#	Material	Capacity ml	g
953000000KK	-	50	-

QUICK LINK

- Oval quick link available in stainless steel and carbon steel.
- Maglia rapida ovale disponibile in acciaio inox e acciaio al carbonio.

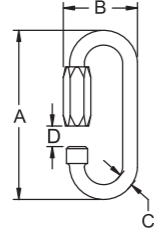

"D" QUICK LINK

- "D" shape carbon steel quick link.
- Maglia rapida in acciaio al carbonio, forma semirotonda a "D".

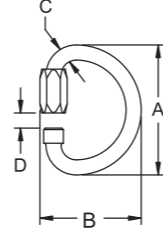

TRAPEZIUM QUICK LINK

- Trapezoidal stainless steel quick link.
- Maglia rapida trapezoidale in acciaio inox.

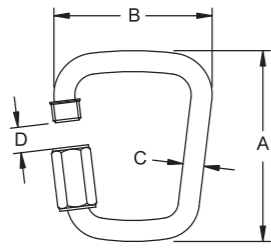

QUICK LINK ASYMMETRIC

- Asymmetric carbon steel quick link.
- Conceived for use with our Duck rope clamp or other small devices.
- Maglia rapida asimmetrica in acciaio al carbonio.
- Ideata per utilizzo con bloccante Duck o altri dispositivi di regolazione della fune.

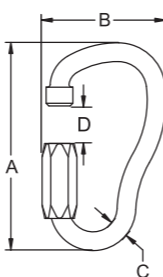

TRIANGLE QUICK LINK

- Triangle stainless steel quick link.
- Maglia rapida triangolare in acciaio inox.

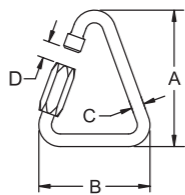

QUICK LINK LONG

- Oval stainless steel quick link wide opening.
- Maglia rapida ovale in acciaio inox con ampia apertura.

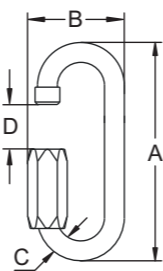

ARGON SETS

- **SET ARGON WIRE** - Ultralight quickdraw set (only 69g!) fitted with two wire gate connectors. The perfect choice for those who look for maximum lightness.
- **SET ARGON MIX** - the KeyLock connector helps with unclipping from the bolt or hanger when cleaning while the wire gate connector helps with clipping the rope in while climbing.
- **SET ARGON KK** - KeyLock system on both connectors in order to avoid every possible catch.
- **SET ARGON WIRE** - Rinvio ultraleggero (solo 69g!) composto da due connettori con leva a filo. Ideale per chi cerca il massimo della leggerezza.
- **SET ARGON MIX** - Il connettore Key Lock agevola il disinserimento dallo spit mentre il leva a filo favorisce l'inserimento della corda. Il perfetto compromesso tra leggerezza e funzionalità.
- **SET ARGON KK** - Sistema Key Lock su entrambi i connettori per evitare qualunque impiglio. Perfetto per chi cerca la praticità d'utilizzo.

#	Standards	Material	Sling	Color	g
ARGON WIRE QUICKDRAW					
761SET5480K	• EN 12275	alu alloy	Dyneema®	■ ■	69
ARGON MIX QUICKDRAW					
761SET5490K	• EN 12275	alu alloy	Dyneema®	■ ■	83
ARGON KK QUICKDRAW					
761SET5500K	• EN 12275	alu alloy	Dyneema®	■ ■	92

ARGON WIRE QUICKDRAW



908 ARGON F

270D.012 EXPRESS DYNEEMA® (12 cm)

908 ARGON F

ARGON MIX QUICKDRAW



719 ARGON K

270D.012 EXPRESS DYNEEMA® (12 cm)

909 ARGON RF

ARGON KK QUICKDRAW



719 ARGON K

270D.012 EXPRESS DYNEEMA® (12 cm)

729 ARGON RK

#	Standards	Material	Color	M.B.S. ◀ kN	M.B.S. ◆ kN	M.B.S. ▶ kg	W.L.L. ◀ kg	g	A mm	B mm	C mm	D mm
Quick link												
400AB0101XK	-	carbon steel	■ ■	-	-	-	-	12	41	21	4	6
400BB0101XK	-	carbon steel	■ ■	-	-	-	-	20	50	25	5	7
400CB0101XK	-	carbon steel	■ ■	-	-	-	-	32	59	29	6	8
400EB0101XK	-	carbon steel	■ ■	-	-	-	-	76	73	38	8	10
400IB0101XK	-	carbon steel	■ ■	-	-	-	-	135	88	45	10	12
400MB0101XK	-	carbon steel	■ ■	-	-	-	-	230	105	52	12	16
5009C0P0PKK	-	stainless steel 304	■ ■	-	-	1100	220	9	37	17	3,5	5,5
500AC0P0PKK	-	stainless steel 304	■ ■	-	-	1400	280	13	41	21	4	6
500BC0P0PKK	-	stainless steel 304	■ ■	-	-	2250	450	22	50	26	5	7
500CC0P0PKK	-	stainless steel 304	■ ■	-	-	3250	650	34	58	29	6	8
500EC0P0PKK	EN 12275/Q - EN 362/Q	stainless steel 304	■ ■	40	20	-	-	79	74	39	8	10
500IC0P0PKK	EN 12275/Q - EN 362/Q	stainless steel 304	■ ■	60	20	-	-	142	89	47	10	12
500MC0P0PKK	-	stainless steel 304	■ ■	-	-	12500	2500	222	105	52	12	14
Trapezium quick link												
538FC0P0PKK	-	stainless steel 316	■ ■	-	-	4900	980	129	82	68	9	11
Triangle quick link												
502EC0P0PKK	EN 12275/Q - EN 362/Q	stainless steel 316	■ ■	40	10	-	-	89	72	56	8	10
502IC0P0PKK	EN 12275/Q - EN 362/Q	stainless steel 316	■ ■	60	30	-	-	155	86	66	10	12
502OC0P0PKK	-	stainless steel 316	■ ■	-	-	12250	2450	-	123	85	14	17
"D" quick link												
409LB0101KK	EN 12275/Q - EN 362/Q	carbon steel	■ ■	50	15	-	-	152	87	67	11	-
Quick link asymmetric												
403DB0101KK	EN 12275/B - EN 362/Q	carbon steel	■ ■	25	10	-	-	89	77,5	43,5	7	14
Quick link long												
527EC0P0PKK	-	stainless steel 316	■ ■	-	-	4900	980	85	89	37,5	8	17,5
527FC0P0PKK	-	stainless steel 316	■ ■	-	-	6250	1250	115	95	41	9	19
527IC0P0PKK	-	stainless steel 316	■ ■	-	-	8000	1600	160	105,5	45,5	10	20,5
527MC0P0PKK	-	stainless steel 316	■ ■	-	-	11000	2200	260	124	52,5	12	23,5

◀ Major axis ◆ Minor axis M.B.S. Minimum breaking strength W.L.L. Working load limit

TRAPPER ANNIVERSARY QUICKDRAW

- The set is composed of 5 vivid colours that make it really easy to give beta once they're placed on a route.
- Equipped with two Trapper connectors with a nice handling shape, standard size that's durable but not too heavy and an easy to clip Keylock nose.
- The Dyneema® sling is 13mm by 12cm, with the new ultra-resistant Fast Rubber made of silicone.
- Sold hanging in our new Eco Pack made of recycled cardboard.
- Il set è composto da 5 rinvii in colori vivaci che facilitano la loro individuazione una volta posizionati su una via, in particolar modo per i principianti.
- Composto da due connettori Trapper particolarmente apprezzati per la loro maneggevolezza, per le dimensioni standard resistenti ma non troppo pesanti e per il sistema Keylock.
- Fettuccia in Dyneema® da 13 mm e lunghezza 12 cm, accompagnata dal nuovo Fast Rubber ultra-resistente in silicone.
- Confezionati col nostro nuovo Eco Pack realizzato in cartone riciclato.

ERGO ANNIVERSARY QUICKDRAW

- The set is composed of 5 vivid colours that make it really easy to give beta once they're placed on a route.
- Equipped with two super strong Ergo connectors with a great handling shape, a generous size that's easy to clip and a Keylock nose.
- The Dyneema® sling is 13mm by 12cm, with the new ultra-resistant Fast Rubber made of silicone.
- Sold hanging in our new Eco Pack made of recycled cardboard.
- Il set è composto da 5 rinvii in colori vivaci che facilitano la loro individuazione una volta posizionati su una via, in particolar modo per i principianti.
- Composto da due connettori Ergo super resistenti, particolarmente apprezzati per la loro maneggevolezza, le dimensioni che ne facilitano l'utilizzo e il sistema Keylock.
- Fettuccia in Dyneema® da 13 mm e lunghezza 12cm, accompagnata dal nuovo Fast Rubber ultra-resistente in silicone.
- Confezionati col nostro nuovo Eco Pack realizzato in cartone riciclato.

INDOOR QUICKDRAW

- Special quickdraw for indoor climbing walls, fitted with a stainless steel quick link and an Indoor connector.
- Rinvio ideale per attrezzare le pareti di arrampicata indoor, composto da maglia rapida in acciaio inox e connettore Indoor.

FAST-RUBBER

- New sling stopper made of ultra-durable rubber, to be inserted on the body of the carabiner. One size fits all, for carabiners with body diameter from 8 to 11 mm.
- 10 pieces per packaging. Not sold individually.
- Nuovo ferma fettuccia realizzato in gomma ultra-resistente, da infilare sul corpo del moschettoni. Misura unica, per moschettoni con diametro filo del corpo da 8 a 11 mm.
- Confezione da 10 pezzi. Non vendibile singolarmente.

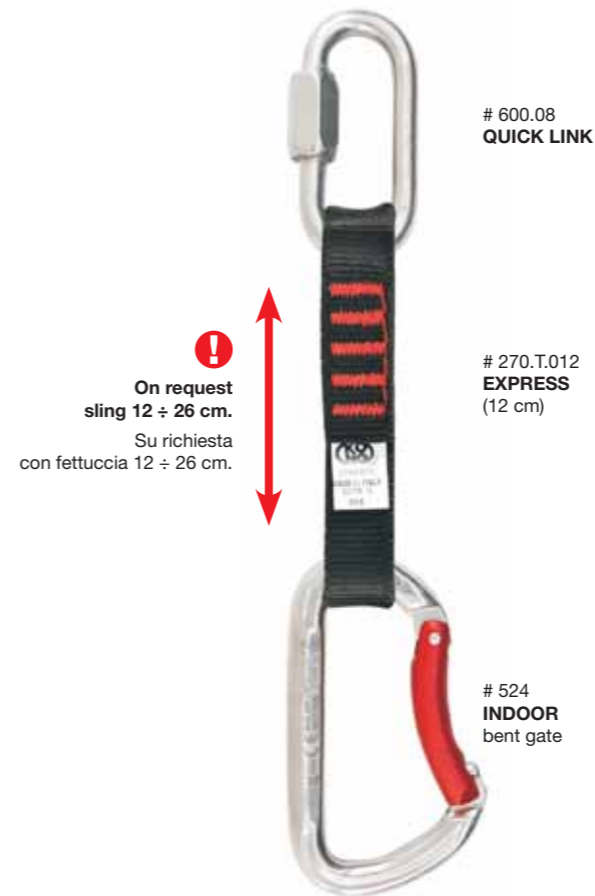
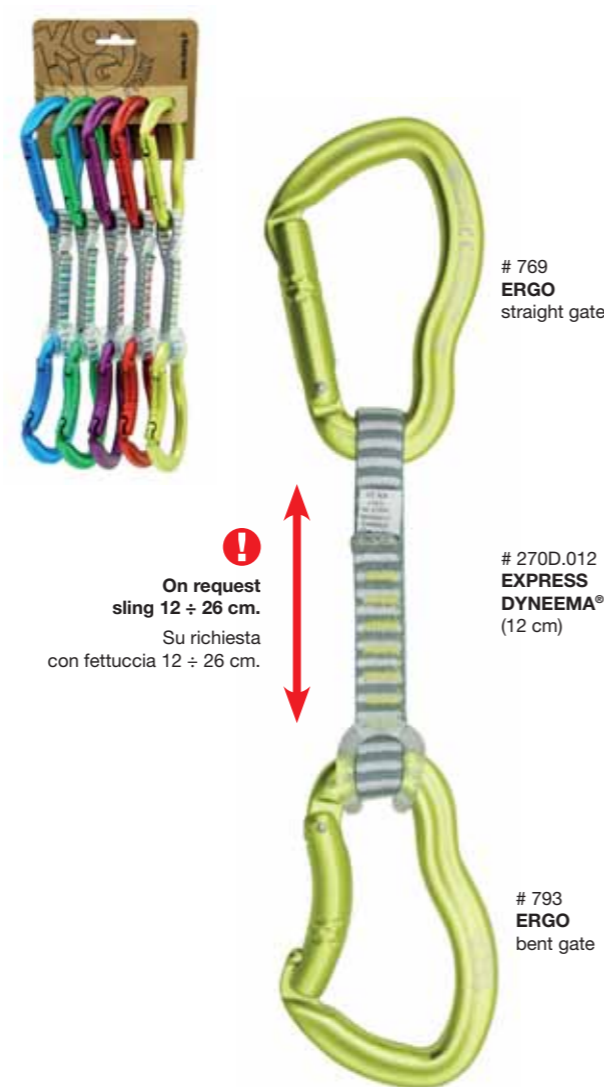

#	Material	Color	DØ mm
81011SET0KK	rubber	□	8÷11



#	Standards	Material	Color	g/cad.
761SET60K0K	EN 12275	alu alloy	■	110

#	Standards	Material	Color	g/cad.
761SET37K0K	EN 12275	alu alloy	■	125

#	Standards	Material	Sling	Color	g
761SET1800K	• EN 12275	stainless steel	nylon	■ ■	215

PANIC

- Panic provides extra reach to those distant bolts and anchor points.
- Panic is fitted with:
 - tubular webbing with an inner flexible bar that allows it to be held straight or slightly curved
 - a special connector equipped with an ingenious system that keeps the gate open until it comes into contact with the bolt. At this point the mechanism releases the gate and the connector closes automatically. The mechanism also prevents accidental gate opening when it is under load.
- Panic is perfect for reaching and clipping distant bolts while onsighting, projecting and exploring new ground.
- Available in the standard version (30 cm) and XL version (45 cm).
- Moschettone a chiusura automatica con fettuccia semirigida: un aiuto per raggiungere gli spit piu' lontani!
- Composto da:
 - una fettuccia tubolare con all'interno una bacchetta flessibile con la quale è possibile ottenere la curvatura desiderata
 - un connettore Ergo Wire modificato, dotato di ingegnoso sistema che tiene aperta la leva fino a quando non entra in contatto con lo spit; a questo punto il meccanismo rilascia la leva e il connettore si chiude automaticamente. Il meccanismo impedisce l'apertura accidentale della leva quando è sotto carico.
- Panic è la versione di "fabbrica" di un classico attrezzo per alpinismo e arrampicata, utile per facilitare il moschettonaggio su tiri di arrampicata con chiodatura lunga e/o con passaggi difficili...
- Disponibile in versione standard da 30 cm e in versione XL da 45 cm

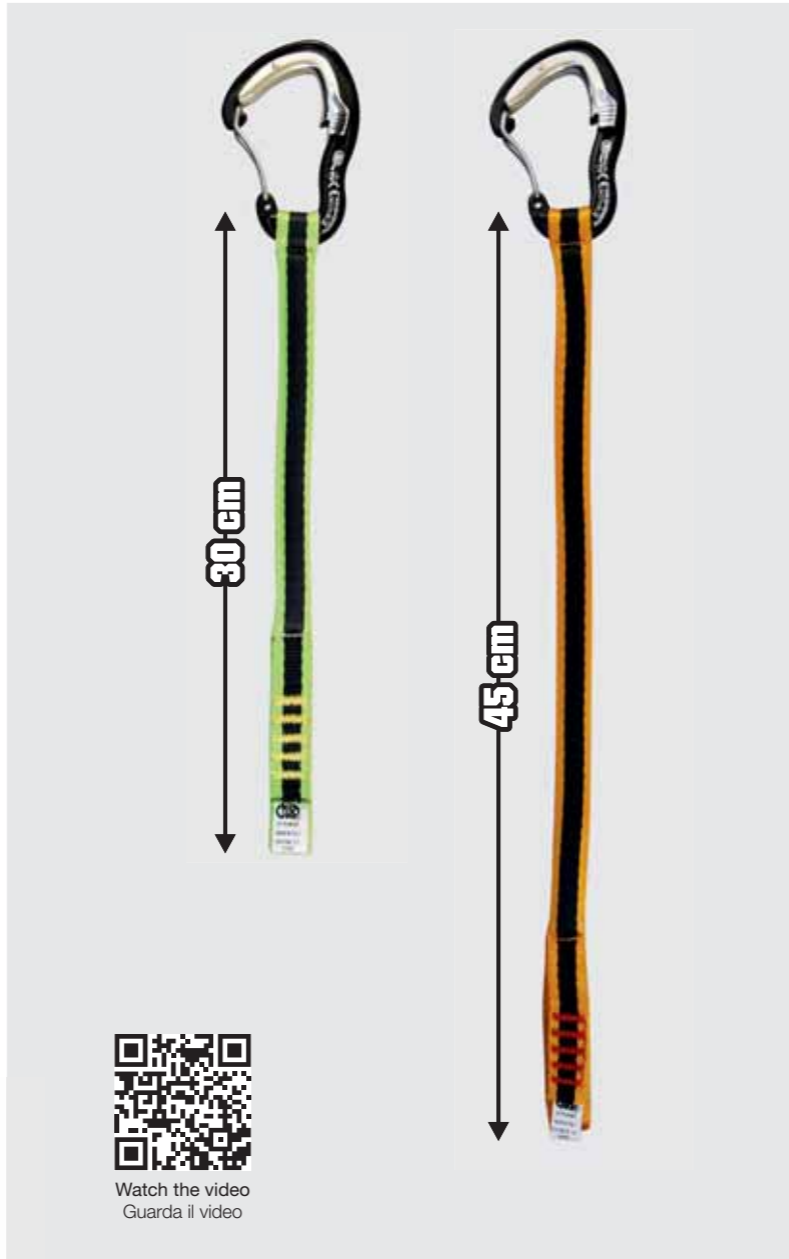

Watch the video
Guarda il video



Panic! A little help to catch the most distant bolts.
Panic! Un aiuto per raggiungere gli spit più distanti.

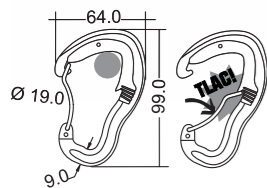

#	Standards	Material	Color	g	kN	mm
907SET001KK	• EN 12275	alu alloy	■ ■	115	23	30
907SET002KK	• EN 12275	alu alloy	■ ■	135	23	45

PROG

- Compared to PANIC is still gains some centimeters because the insertion in the spit takes place directionally from the bottom.
- Moreover, the PROG is certified both EN 12275 and EN 362 for professional use.
- Available in standard version (35 cm) and XL version (50 cm).
- Rispetto al PANIC si guadagna ancora qualche centimetro dato che l'inserimento nello spit avviene direzionalmente dal basso.
- Inoltre il PROG è certificato sia EN 12275 che EN 362 per applicazioni in ambito professionale.
- Disponibile in versione standard da 35 cm e in versione XL da 50 cm.

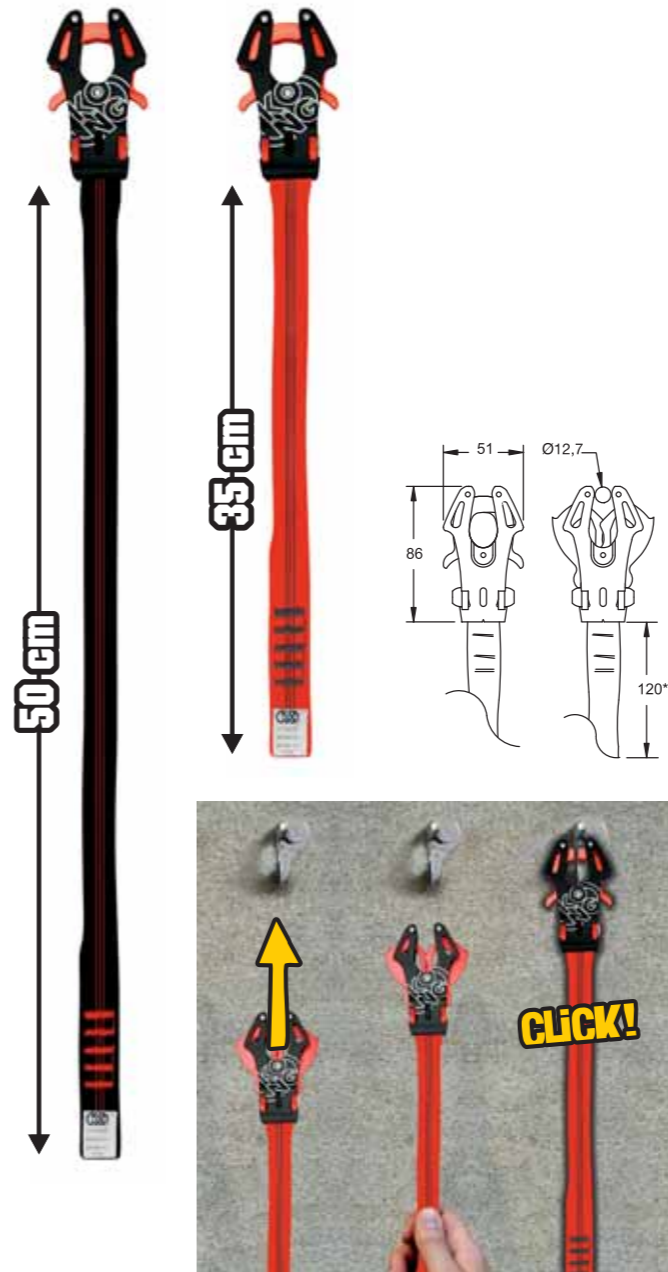

#	Standards	Material	Color	g	kN	mm
704SET001KK	• EN 12275/A • EN 362/A/T	alu alloy	■ ■	110	-	35
24150NRN0KK	• EN 12275/A • EN 362/A/T	alu alloy	■ ■	130	-	50

FROG

- With an innovative approach that characterizes KONG comes the Frog, a revolutionary directional connector with an automatic clamping action that engages when it touches the anchor point.
- Produced after an intensive design phase in collaboration with Politecnico of Milan, the Frog is a totally new connector, both in its appearance and mechanism.
- Frog makes the concept of a carabiner thought of as a "hook" obsolete.
- The insertion is extraordinarily quick and safe, even in "distant" anchor points, not easily reached with standard connectors.
- It automatically clamps when coming into contact with the anchor point.
- Sling length of 120mm.
- Dallo spirito innovativo che distingue Kong è nato il Frog. Un rivoluzionario connettore unidirezionale, dotato di chiusura automatica che agisce a contatto del punto d'ancoraggio.
- Prodotto dopo un lungo studio in collaborazione con il Politecnico di Milano, Frog è un connettore del tutto particolare, sia nella forma sia nel meccanismo.
- Frog cambia completamente il concetto di moschettone inteso come "gancio".
- L'inserimento è straordinariamente rapido e sicuro anche per ancoraggi "lontani", non accessibili con connettori classici.
- Si chiude automaticamente entrando in contatto con l'ancoraggio.
- Fettuccia di 120mm di lunghezza.



Watch the video
Guarda il video



FROG QUICKDRAW



#	Standards	Material	Color	kN	kN	kN	g
FROG							
24016NOO0KK	• EN 12275 • EN 362/A/T	alu alloy	■ ■	23	-	-	75
FROG QUICKDRAW							
761SET4000K	• EN 12275 • EN 362/A/T	alu alloy	■ ■	-	-	-	130

FROG 360

NEW

- FROG 360 is the integration of our famous FROG connector with a "textile friendly" swivel.
- It allows direct connection with textile elements and the creation of no-twisting lanyards.
- Thanks to the innovative automatic closing system of the gates, it allows a quick and safe directional connection.
- FROG 360 è l'integrazione del nostro famoso connettore FROG con un girello "textile friendly"!
- Permette il collegamento diretto con elementi tessili per assemblare cordini anti-attorcigliamento.
- Grazie all'innovativo sistema di chiusura automatica delle leve permette un rapido e sicuro collegamento direzionale.

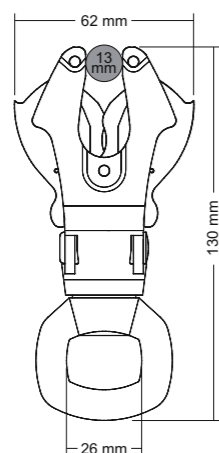

FROG CABLE

- With an innovating approach, that characterizes KONG, comes out Frog, a revolutionary directional connector, provided with an automatic clamping that takes place touching the anchor point.
- Produced after a hard design in collaboration with Politecnico di Milan, Frog is a totally new connector, both in the appearance and in the mechanism.
- Frog makes obsolete the concept of a carabiner thought as a "hook".
- The insertion is extraordinary quick and safe, even in "far" anchor points, not easy to be reached with standard connectors.
- It automatically clamps coming into contact with anchor point.
- Special for anchoring on metal cables.
- Nello spirito innovativo che distingue la Kong è nato il Frog, un rivoluzionario connettore unidirezionale, dotato di chiusura automatica che agisce a contatto del punto d'ancoraggio.
- Prodotto dopo un lungo studio in collaborazione con il Politecnico di Milano, Frog è un connettore del tutto particolare, sia nella forma sia nel meccanismo.
- Frog cambia completamente il concetto di moschettone inteso come "gancio".
- L'inserimento è straordinariamente rapido e sicuro anche per ancoraggi "lontani", non accessibili con connettori classici.
- Si chiude automaticamente entrando in contatto con l'ancoraggio.
- Ideale per ancoraggi su cavi metallici.

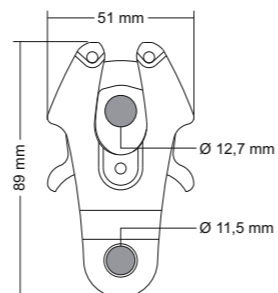

#	Standards	Material	Color	kN	kN	kN	g
FROG CABLE							
7000XGNN0KK	EN 12275/A EN 362/A/T	alu alloy	■ ■	25	-	-	50

FROG NUDE

NEW

- Frog Nude is the disassembled version of our popular Frog unidirectional connector.
- It is supplied disassembled and without markings, to allow our customers to personalize it with their own logo and mount it on leashes, lanyards, camera harnesses and so on...
- Unlike the standard version, the Frog Nude is not a PPE, it is not certified and therefore not suitable for human load.
- The Frog family is expanding, soon other big news...
- Frog Nude è la versione smontata del nostro famoso connettore unidirezionale Frog.
- Viene fornito smontato e senza marcature, per permettere ai nostri clienti di personalizzarlo con il proprio logo e montarlo su guinzagli, longe, imbragature per telecamere e quant'altro...
- A differenza della versione standard, il Frog Nude non è un DPI, non è certificato e quindi non è adatto per il carico umano.
- La famiglia Frog si allarga, a breve altre grosse novità...

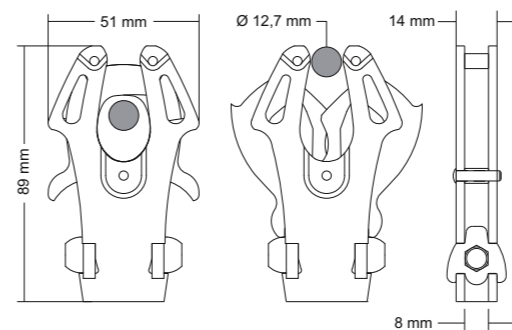

#	Standards	Material	Color	kN	kN	kN	g
FROG NUDE							
7040XNN0XX	-	alu alloy	■ ■	-	-	-	60

MINI FROG

NEW

- Miniaturized version of the famous FROG connector, it maintains the same opening functions of gates with automatic closure.
- Suitable for making leashes, suspension systems of professional cameras, tool lanyards, etc...
- Unlike the standard version, the Mini Frog is not a PPE, it is not certified and therefore not suitable for human load.
- The Frog family is expanding, soon other big news...
- Versione miniaturizzata del famoso connettore FROG, mantiene le stesse funzionalità di apertura delle leve con chiusura automatica a scatto.
- Adatto per realizzare guinzagli, sistemi di sospensione di fotocamere professionali, longe porta-attrezzi, ecc...
- A differenza della versione standard, il Mini Frog non è un DPI, non è certificato e quindi non è adatto per il carico umano.
- La famiglia Frog si allarga, a breve altre grosse novità...

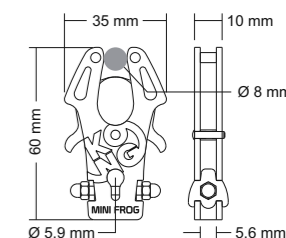

#	Standards	Material	Color	kN	kN	kN	g
MINI FROG							
7250XNN0KK	-	alu alloy	■ ■	-	-	-	20

SLINGS FETTUCCE

5



Aro Sling Dyneema®



Aro Sling Tubular



Chain Dyneema®

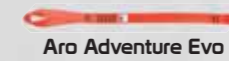

Aro Adventure Evo

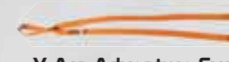

Y Aro Adventure Evo



Double Aro Adventure Evo



Trilonge



Express

ARO SLING DYNEEMA®

- Dyneema® sling. Lighter and softer than polyamide rings.
- Available in various sizes, from 30 to 180 cm in length (60 to 360 cm in circumference).
- Excellent resistance to abrasion.
- Very useful for creating anchor or positioning points.
- Width of tape: 13 mm.
- Breaking strength: 22 kN.
- Anello di fettuccia in Dyneema®. Più leggero e morbido degli anelli in poliammide.
- Disponibile in varie misure, da 30 a 180 cm di lunghezza (da 60 a 360 cm di circonferenza).
- Ottima resistenza all'abrasione.
- Utile per creare punti di ancoraggio o di posizionamento.
- Larghezza della fettuccia: 13 mm.
- Carico di rottura: 22 kN.

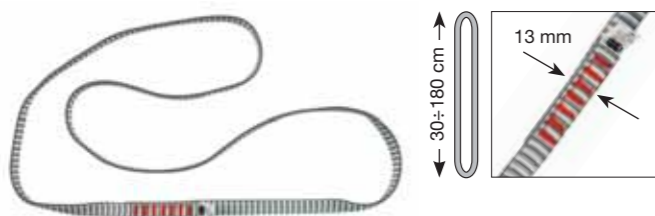

ARO SLING TUBULAR

- Polyamide sling perfect to make a stopover or to extend an anchor point. The product is supplied in different colors to suit lengths.
- Custom lengths are also available upon request. Available in black.
- Width of tape: 15 mm.
- Breaking strength: 23 kN.
- Anello di fettuccia in poliammide. Per realizzare una sosta o un ancoraggio, o prolungare un punto di ancoraggio. Il prodotto è fornito in diversi colori in base alle lunghezze. Disponibili anche misure personalizzate su richiesta. Disponibile nella colorazione nera.
- Larghezza della fettuccia: 15 mm.
- Carico di rottura: 23 kN.



#	Standards	Color	Material	g	kN	cm
ARO SLING DYNEEMA®						
271D030R0KK	EN 795B - EN 354 - EN 566	■	dyneema®	27	22	30
271D060X0KK	EN 795B - EN 354 - EN 566	■	dyneema®	44	22	60
271D080B0KK	EN 795B - EN 354 - EN 566	■	dyneema®	58	22	80
271D120R0KK	EN 795B - EN 354 - EN 566	■	dyneema®	87	22	120
271D150X0KK	EN 795B - EN 354 - EN 566	■	dyneema®	110	22	150
271D180B0KK	EN 795B - EN 354 - EN 566	■	dyneema®	125	22	180
ARO SLING TUBULAR						
271T030R0KK	EN 795/B - EN 354 - EN 566	■	polyamide	28	22	30
271T060G0KK	EN 795/B - EN 354 - EN 566	■	polyamide	45	22	60
271T080O0KK	EN 795/B - EN 354 - EN 566	■	polyamide	60	22	80
271T120R0KK	EN 795/B - EN 354 - EN 566	■	polyamide	90	22	120
271T150Y0KK	EN 795/B - EN 354 - EN 566	■	polyamide	115	22	150
271T180O0KK	EN 795/B - EN 354 - EN 566	■	polyamide	135	22	180
271T250R0KK	EN 795/B - EN 354 - EN 566	■	polyamide	160	22	250

CHAIN DYNEEMA®

- Dyneema® sling for mountaineering, climbing, caving, work and rescue.
- A multiuse sling, designed to be used in rappelling, or employed as safety longe.
- If loaded from one to the other end, this sling can be charged up to 22kN. The other holes work with lower loads, no more than 3kN.
- Made of Dyneema® 13 mm width, 120 cm length.
- Fettuccia multifunzione in Dyneema®, studiata per l'uso come longe di sicurezza (alpinismo, arrampicata, speleologia).
- Se caricata da estremità a estremità, può sostenere carichi fino a 22 kN. Le aperture intermedie possono sostenere un carico minore, non superiore a 3kN.
- Realizzato in Dyneema® da 13 mm di larghezza, lunghezza 120 cm.

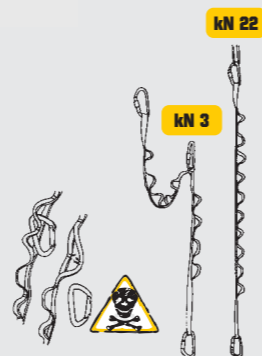
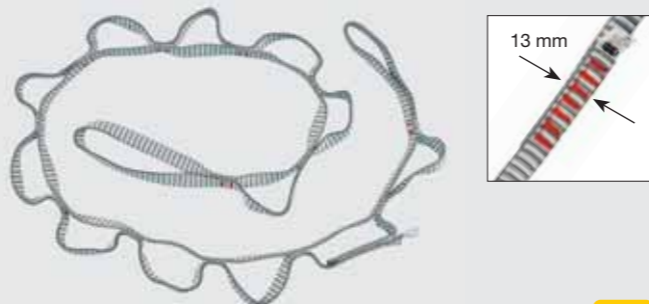

#	Standards	Color	Material	g	kN	cm
CHAIN DYNEEMA®						
273D120X0KK	EN 566	■	dyneema®	85	25	120

ARO ADVENTURE EVO

- NEW**
- Single Nylon lanyard suitable for adventure parks.
- Equipped with a slot for securing the pulley to the harness through a lark's foot knot.
- Available in 4 lengths: 50, 60, 70 and 80 cm.
- Thickness of the sling increased to reduce the risk of use on the minor axis.
- Width 20 mm.
- Load 22 kN.
- Longe singola in Nylon adatta per i parchi avventura.
- Dotata di asola per il fissaggio della carrucola all'imbracatura tramite bocca di lupo.
- Disponibile in 4 lunghezze: 50, 60, 70 e 80 cm.
- Spessore della fettuccia maggiorato per ridurre il rischio di utilizzo sull'asse trasversale.
- Larghezza 20 mm.
- Carico 22 kN.



Y ARO ADVENTURE EVO

- NEW**
- Double Nylon lanyard fitted with two arms, suitable for adventure parks.
- Equipped with a slot for securing to the harness through a lark's foot knot.
- It must be used with two connectors, possibly fitted with safety sleeve (not included).
- Available in 2 lengths: 85 and 100 cm.
- Thickness of the sling increased to reduce the risk of use on the minor axis.
- Width 20 mm
- Load 22 kN
- Longe doppia a due bracci in Nylon adatta per i parchi avventura.
- Dotata di asola per il fissaggio all'imbracatura tramite bocca di lupo.
- Da utilizzare in abbinamento a due connettori, preferibilmente dotati di ghiera di sicurezza (non inclusi).
- Disponibile in 2 lunghezze: 85 e 100 cm.
- Spessore della fettuccia maggiorato per ridurre il rischio di utilizzo sull'asse trasversale.
- Larghezza 20 mm.
- Carico 22 kN.



#	Standards	Color	Material	g	kN	cm
ARO ADVENTURE EVO						
2150050R0KK	EN 354 - EN 17109	■	nylon	56	20	50
2150060R0KK	EN 354 - EN 17109	■	nylon	67	20	60
2150070R0KK	EN 354 - EN 17109	■	nylon	76	20	70
2150080R0KK	EN 354 - EN 17109	■	nylon	90	20	80
Y ARO ADVENTURE EVO						
2160085O0KK	EN 354 - EN 17109	■	nylon	170	20	85
2160100O0KK	EN 354 - EN 17109	■	nylon	203	20	100

DOUBLE ARO ADVENTURE EVO

- NEW**
- Nylon lanyard for use in adventure parks to connect the pulley Zip Evo to the harness. Made of 20 mm tape with twisted loops that allow a connection with a lark's foot knot to the harness and to the pulley.
- Available in 3 lengths: 40, 52 and 69 cm.
- Thickness of the sling increased to reduce the risk of use on the minor axis.
- Load: 22 kN
- Longe in nylon da utilizzare in parchi avventura per collegare la carrucola Zip Evo all'imbracatura. Realizzata in fettuccia da 20 mm con asole ritorte che permettono un collegamento con nodo a bocca di lupo all'imbracatura e alla carrucola.
- Disponibile in 3 lunghezze: 40, 52 e 69 cm.
- Spessore della fettuccia maggiorato per ridurre il rischio di utilizzo sull'asse trasversale.
- Carico: 22 kN



#	Standards	Color	Material	g	kN	cm
DOUBLE ARO ADVENTURE EVO						
2150040N1KK	EN 354 - EN 17109	■	nylon	50	20	40
2150052N1KK	EN 354 - EN 17109	■	nylon	59	20	52
2150069N1KK	EN 354 - EN 17109	■	nylon	78	20	69

TRILONGE

- Positioning lanyard designed for caving, canyoning and rescue activities, made of dynamic rope EN 892 10mm diameter, with sewn eyelets and rubber terminations; available in three lengths for custom arrangement of the three branches of the lanyard.
- Trilonge is the factory version conform to EN 566:06, EN 354:10, EN 358:99, EN 795/B:12 norms, of a popular tool up to date handcrafted by the end user.
- Features:
 - choice of 3 lengths (170 cm - 190 cm - 210 cm) depending on the needs and the user's stature;
 - seam eyelets with a contrasting color indicator for the immediate check of the wear;
 - lanyard lengths designed for the preparation of the 3 attachment points (short, medium, long) via Trilonge knot;
 - rope sheath very resistant to abrasion for use in particularly aggressive environments;
 - rubber terminals integrated for the correct and stable positioning of the connector in the sewn eyelets.
- Cordino di posizionamento studiato per speleologia, canyoning e attività di soccorso, realizzato in corda dinamica EN892 diametro 10mm, con asole cucite e terminali in gomma; disponibile in tre lunghezze per il confezionamento personalizzato dei tre rami della longe.
- La Trilonge è la versione "di fabbrica" e certificata EN 566:06, EN 354:10, EN 358:99, EN 795/B:12 di uno strumento molto diffuso ma fino ad oggi realizzato artigianalmente dall'utilizzatore finale.
- Caratteristiche:
 - possibilità di scelta tra 3 lunghezze (170 cm -190 cm - 210 cm) in funzione delle esigenze e della statura dell'utilizzatore;
 - cucitura delle terminazioni con spia in colore a contrasto per immediata verifica dell'usura;
 - lunghezze del cordino studiate per la preparazione della longe con 3 punti di attacco (corto, medio, lungo) tramite nodo trilonge;
 - calza della corda molto resistente alle abrasioni per un utilizzo in ambienti particolarmente aggressivi;
 - terminali in gomma integrati per il posizionamento corretto e stabile dei moschettoni alle terminazioni cucite.



Watch the video
Guarda il video

3 sizes! 170-190-210 cm.
3 misure! 170-190-210 cm.



#	Standards	Colour	Material	g	kn	cm	Ø mm
TRILONGE							
279100170KK	EN 354	■	nylon	150	22	170	10
279100190KK	EN 566	■	nylon	170	22	190	10
279100210KK	EN 795/B	■	nylon	190	22	210	10

EXPRESS DYNEEMA®

- Dyneema® quickdraw webbing for mountaineering, climbing, caving, canyoning.
- Available in 4 lengths: 12, 16, 21 and 26 cm.
- Fettuccia in Dyneema® ideale per realizzare rinvii per alpinismo, arrampicata, speleologia, torrentismo.
- Disponibile in 4 lunghezze: 12, 16, 21, 26 cm.



EXPRESS

- Nylon quickdraw webbing for mountaineering, climbing, caving, canyoning.
- Available in 4 lengths: 12, 16, 21, and 26 cm.
- Fettuccia in nylon ideale per realizzare rinvii per alpinismo, arrampicata, speleologia, torrentismo.
- Disponibile in 4 lunghezze: 12, 16, 21, 26 cm.



#	Standards	Colour	Material	g	kn	cm
EXPRESS DYNEEMA®						
270D012X0KK	EN 566	■ □ ■	dyneema®	5	22	12
270D016X0KK	EN 566	■ □ ■	dyneema®	6	22	16
270D021R0KK	EN 566	■ □ ■	dyneema®	8	22	21
270D026B0KK	EN 566	■ □ ■	dyneema®	10	22	26
EXPRESS						
270T01200KK	EN 566	■	nylon	10	23	12
270T01600KK	EN 566	■	nylon	12	23	16
270T016Y0KK	EN 566	■	nylon	12	23	16
270T021Y0KK	EN 566	■	nylon	16	23	21
270T02600KK	EN 566	■	nylon	19	23	26

DESCENDERS DISCENSORI

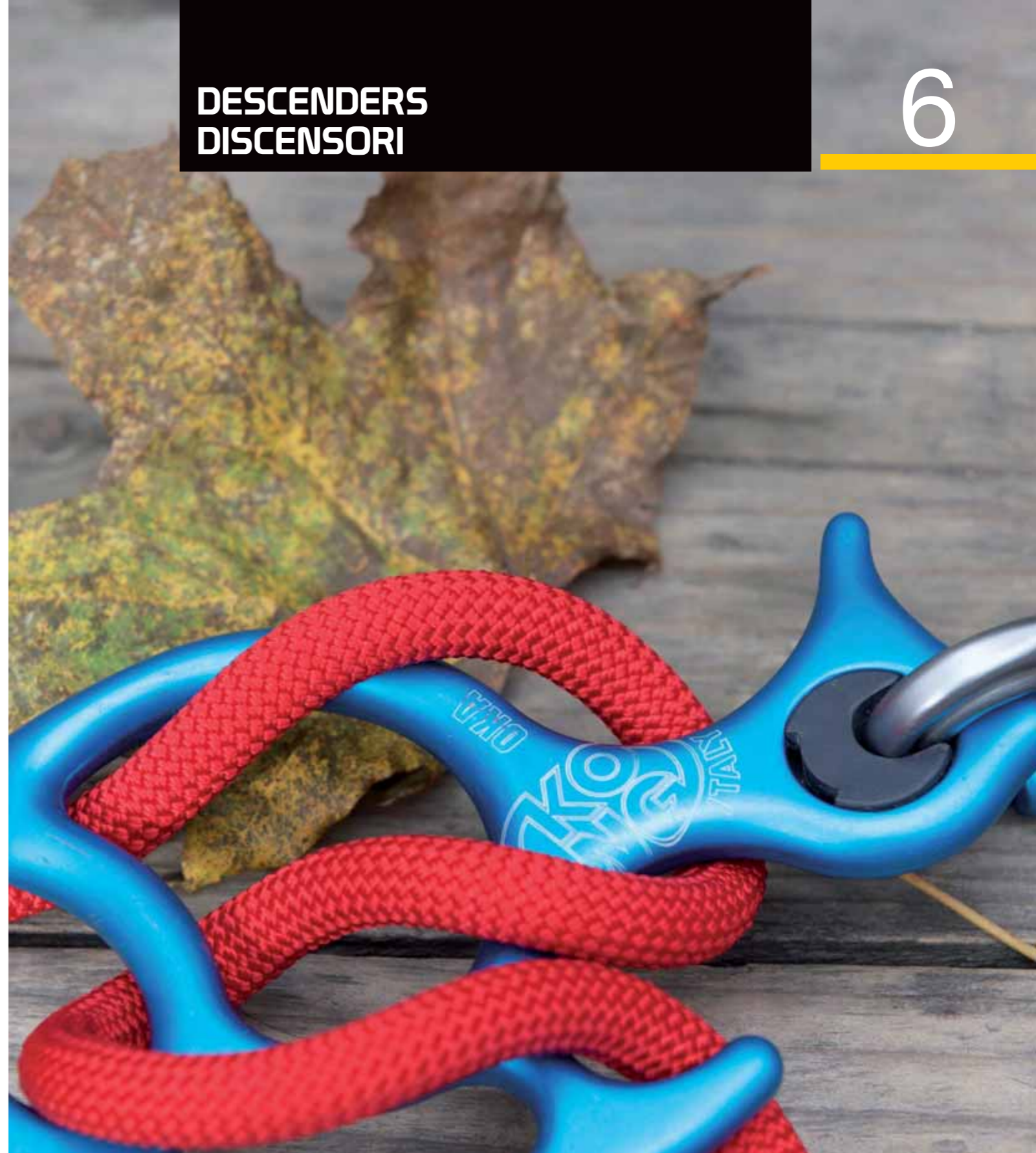

Oka



Oka-X



8 Classic



Big 8 Alu



Hydrobot



Rackong



Chuy



Full



Gi-Gi

OKA

- Descender especially conceived for canyoning, designed not only for progression on rope but also for use in emergency, recovery and rescue situations which are very difficult to manage with other devices.
- Quick, safe and effective function in all conditions.
- The ease of operation, diversity of progression techniques on ropes of different diameters, and the multitude of braking positions are characteristics achieved through its joint development with rescue technicians.
- Connector suggested: Large Multiuse Auto Block #737.V1
- Available as a set OKA + Large Multiuse Auto Block connector # 805SET001KK
- Supplied with two spare rubber parts.
- Nuovo discensore studiato per il torrentismo, concepito non solo per la progressione su corda ma anche per l'utilizzo in situazioni di emergenza, recupero e soccorso difficilmente gestibili con altri dispositivi.
- L'utilizzo è rapido, sicuro ed efficace in ogni condizione.
- La facilità di manovra, la modularità di progressione su corde di diverso diametro e la molteplicità di posizione di frenaggio sono caratteristiche ottenute grazie allo sviluppo congiunto con i tecnici del soccorso.
- Moschettone consigliato: Large Multiuse Auto Block # 737.V1
- Disponibile set OKA + connettore Large Multiuse Auto Block # 805SET001KK
- Fornito con due gommini blocca-connettore di ricambio.



#	Standards	Material	Color	g	Ø mm min.	Ø mm max.
80508B400KK	EN 15151-2	alu alloy	Blue	95	7,8	12,7
80508N400KK	EN 15151-2	alu alloy	Black	95	7,8	12,7

KIT OKA + LARGE MULTIUSE AUTOBLOCK

805SET001KK

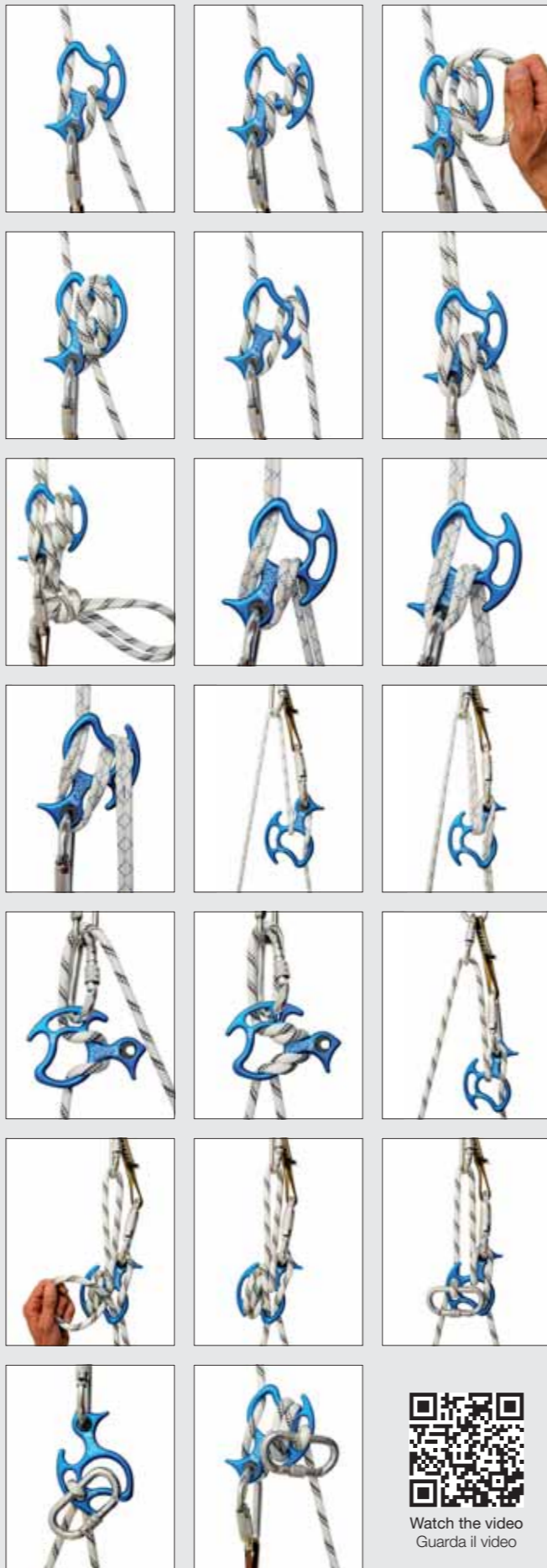

Watch the video
Guarda il video

OKA-X

NEW

- Service descender, version with a completely smooth loop for the connector inserting, without rubber or fins.
- Designed to be installed in the abseiling belay as a quick, safe and versatile tool in canyoning progression.
- It allows an easy rope adjustment, management of rock rubbings, assisted release and it's an efficient tool in canyon progressions.
- Perfect for rescue operations during abseiling and recovery and in the emergency situations, it's a tool developed with and for canyoning professionals.
- Discensore di servizio, versione con asola per inserimento del connettore completamente liscia, senza gommino né alette.
- Concepito per essere installato nella sosta di calata come attrezzo rapido, sicuro e versatile nella progressione in torrentismo.
- Permette una facile regolazione della corda, la gestione degli sfregamenti sulla roccia, lo svincolo assistito ed è uno strumento efficace per le grandi calate.
- Perfetta per le manovre di soccorso in calata e in recupero e nell'utilizzo in situazioni di emergenza, è uno strumento sviluppato con e per i professionisti dell'ambiente forra.

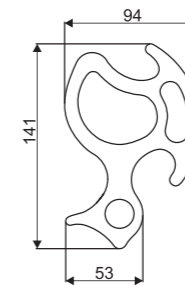

#	Standards	Material	Color	g	Ø mm min.	Ø mm max.
80508O401KK	EN 15151-2	alu alloy	Orange	95	7,8	12,7

HYDROBOT

NEW

- Hydrobot is a special tool conceived for modern canyoning; it can be used both with one or two ropes and allows easy braking variation under load.
- Compared to other models, Hydrobot helps prevent accidental loss, avoids rope twisting and avoids wear on the connector.
- The characteristic which makes Hydrobot unique is the possibility to use it as an auto-locking device in case of emergency, ascending on one or two ropes (in conjunction with a Prusik knot).
- The possibility of overturning the central bar (fixed by a screw) allows use by left-handers.
- Hydrobot is the only descending device fitted with a magnet to retain the mobile bar!
- Discensore studiato per il torrentismo moderno, molto utile anche per manovre di alpinismo; funziona con una o due corde e permette di variare l'effetto frenante sotto carico.
- Rispetto ad altri modelli è imperdibile, non causa l'usura del connettore cui è agganciato e soprattutto non attorciglia le corde.
- La caratteristica che rende davvero esclusivo Hydrobot è la possibilità di fungere da auto-bloccante nella risalita d'emergenza su una o due corde. Un vero e proprio bloccante sempre montato al quale accoppiare un prusik o un bloccantino per risalire qualsiasi corda! Pur avendo una geometria asimmetrica, grazie alla possibilità di invertire il cursore, può essere utilizzato comodamente anche dai mancini. La chicca finale: Hydrobot è l'unico attrezzo nel campo delle attrezzature alpinistiche ad utilizzare un magnete!

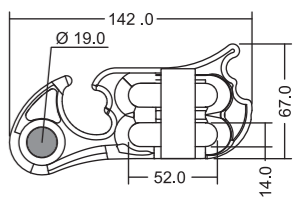
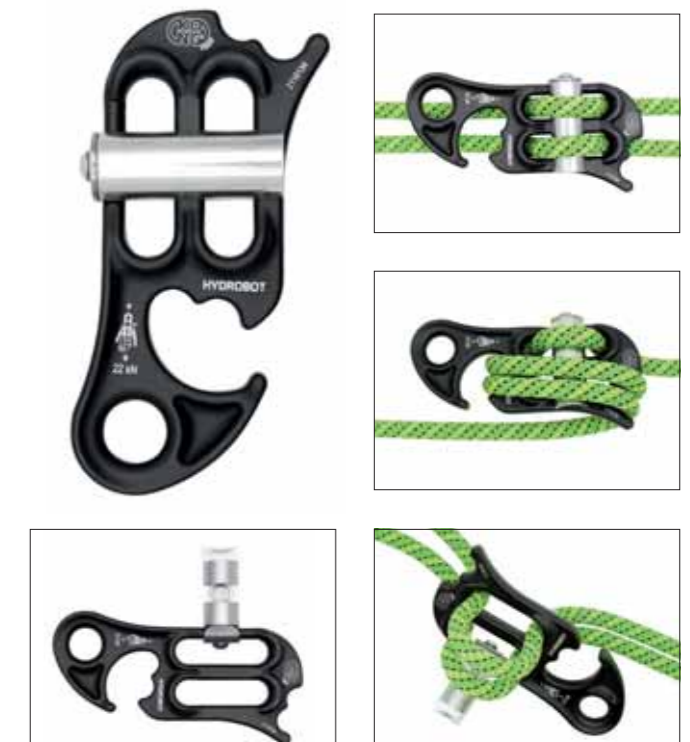

#	Standards	Material	Color	g	Ø mm min.	Ø mm max.
8001NP300KK	-	alu alloy	Black	170	5	12

8 CLASSIC

- Classic figure of '8' descender. Perfect for belaying the first climber with half, single or double ropes.
- A true workhorse for Kong which continues to be popular all over the world.
- Works on ropes from 9 to 12 mm.
- Available in 5 vivid colours.
- Classico discensore a '8'. Ideale per assicurazione del primo di cordata, per uso in discesa con mezza corda, corda singola e doppia.
- Un vero cavallo di battaglia per Kong, che continua ad essere apprezzato in tutto il mondo.
- Funziona su corde da 9 a 12 mm.
- Disponibile in 5 vivaci colori misti.

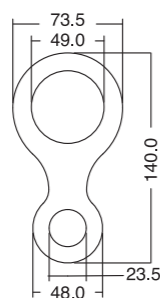

BIG 8 ALU

- Figure '8' descender with wings to allow lock-off. Perfect for belaying the first climber with double ropes.
- The large central opening allows you to pass rope knots.
- Works on ropes from 9 to 16 mm
- Available in alu alloy and stainless steel versions.
- Discensore a '8' con appendici per bloccaggio corda e creazione di una chiave di arresto. Ideale per assicurazione del primo di cordata e per discesa in corda doppia.
- La grande apertura centrale consente di superare eventuali nodi sulle corde.
- Funziona su corde da 9 a 16 mm
- Disponibile in alluminio e in acciaio inox.

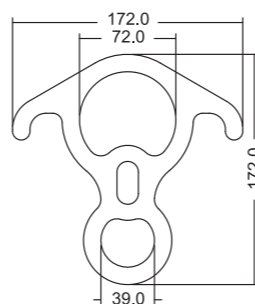

#	Standards	Material	Color	g	Ø mm min.	Ø mm max.
80503N400KK	NIT 271-1 NIT 271-2 EN 15151-2	alu alloy	■	110	9	12
80503B400KK	NIT 271-1 NIT 271-2 EN 15151-2	alu alloy	■	110	9	12
80503P100KK	NIT 271-1 NIT 271-2 EN 15151-2	alu alloy	■	110	9	12
80503R400KK	NIT 271-1 NIT 271-2 EN 15151-2	alu alloy	■	110	9	12

#	Standards	Material	Color	g	Ø mm min.	Ø mm max.
80506N400KK	-	alu alloy	■	260	9	16
80506P100KK	-	alu alloy	■	260	9	16
80506R400KK	-	alu alloy	■	260	9	16
805050000KK	-	stainless steel	■	750	9	16

RACKONG

- Descender with a stainless steel body and aluminum bars, it allows continuous speed variation by moving the bars: distant bars for high speed, close bars for low speed. It doesn't twist the rope.
- Discensore con corpo in acciaio inox e barrette in alluminio che permette una variazione continua della velocità spostando le barre: a barre distanti corrisponde una velocità piu' elevata, a barre ravvicinate una velocità inferiore. Non attorciglia le corde.

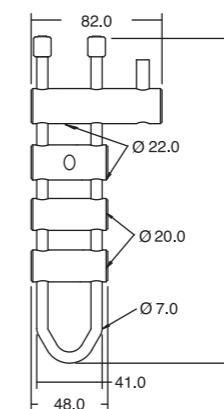

#	Standards	Material	Color	g	Ø mm min.	Ø mm max.
808BPR900KK	-	alu alloy	■ ■ ■	280	9	13

CHUY

- The Chuy is a belay and rappel device that works on half, twin and single ropes. Very light, the user can change the braking capacity thanks to the "V" shape notches, so as to modulate the effort of the user according to their own weight, the rope used, and all those factors that modify friction and consequently the braking. It gives a smooth feed, strong braking and a great look. Conforms to the norm EN 15151-2 for manual braking devices.
- It is recommended for use with HMS screw sleeve connectors.
- Il nuovo Chuy è un assicuratore discensore che funziona su mezze corde, corde gemelle e corde singole. Molto leggero, ha il pregio di poter variare la capacità frenante grazie alle gole a "V" così da modulare lo sforzo dell'utilizzatore in base al proprio peso, alla corda utilizzata e a tutti quei fattori che modificano l'attrito e di conseguenza la frenatura. Fluidità di funzionamento, ottimo frenaggio e look accattivante. Conforme alla recente norma per i dispositivi di frenaggio a comando manuale EN 15151-2.
- Ne consigliamo l'uso in abbinamento ad un connettore HMS con ghiera a vite.

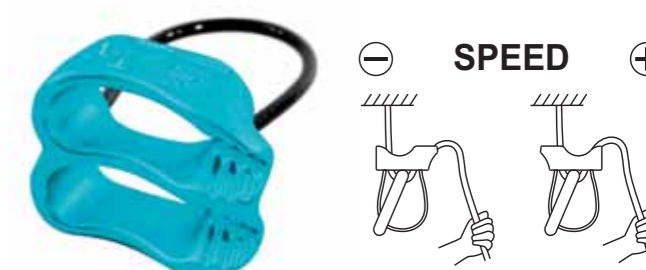

#	Standards	Material	Color	g	Ø mm min.	Ø mm max.
940B00400KK	-	alu alloy	■	55	8	12
940N00400KK	-	alu alloy	■	55	8	12

FULL

- A belay plate that can be used in many different conditions.
- Innovative three hole rigging plate certified to EN 795/B for 5 people, it can also be used as a brake for rappelling with single or double ropes.
- It is a very useful device for rescue operations, the natural choice for mountain experts. It allows a cleaner belay point, avoiding tricky and cumbersome chains of carabiners and plates. The wide upper hole is able to accommodate two connectors for higher safety. When used as a descending device, it works with ropes from 8 to 12mm.
- Una piastrina d'assicurazione che può essere utilizzata anche come multi-ancoraggio.
- Innovativa piastrina multiancoraggi a tre fori certificata EN 795/B per 5 persone, utilizzabile anche come freno per la calata con corde doppie o singole.
- Perfetta per le manovre di soccorso, è lo strumento ideale per i professionisti della montagna. Permette una maggiore pulizia in sosta evitando complicate e ingombranti catene di moschettoni e freni. L'ampio foro superiore è in grado di alloggiare due connettori per una maggiore sicurezza. Come discensore funziona con corde da 8 a 12mm.

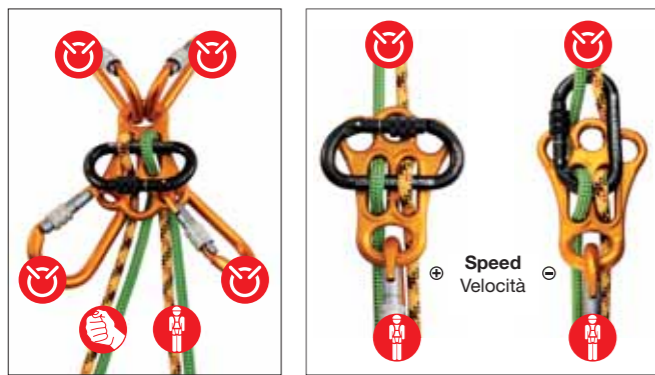
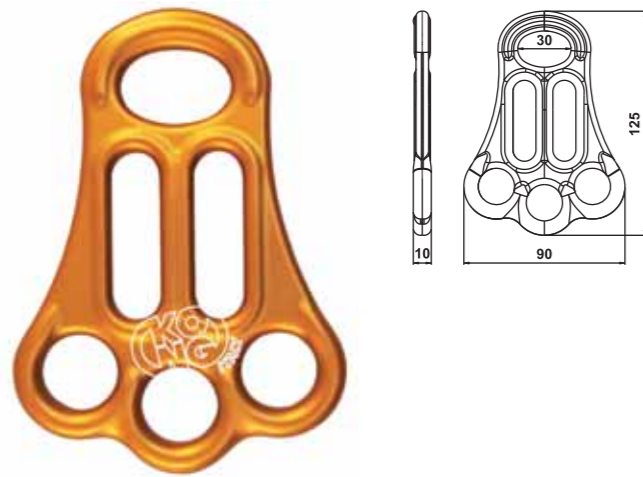

#	Standards	Material	Color	g	Ø mm min.	Ø mm max.
864O15400KK	-	alu alloy	Orange	90	8	12
864N15400KK	-	alu alloy	Black	90	8	12

GI-GI

- A real workhorse for Kong!
- Multipurpose hot-forged aluminum plate for use with single, double and twin ropes.
- Its main applications are self-locking belaying for one or two seconds and abseiling.
- The central rib acts as a fulcrum on the connector and allows the recovery of two people, even secured to ropes of different diameter, either simultaneously or separately. In the case of a fall, only the rope subjected to the fall blocks, leaving the other free to slide.
- It is possible to use the GI-GI in combination with a self-locking device and a foot pedal for emergency lifting.
- Un vero cavallo di battaglia di Kong!
- Piastrina di assicurazione multiuso in alluminio forgiato a caldo, utilizzabile con corda singola, doppia, gemellare.
- Le sue applicazioni principali sono le seguenti: assicurazione autobloccante di uno o due secondi di cordata; discesa in corda doppia.
- La speciale costolatura centrale agisce come fulcro sul connettore e permette di recuperare due persone anche assicurate a corde di differente diametro, sia contemporaneamente che separatamente perchè in caso di caduta solamente la corda sottoposta a strappo si blocca lasciando l'altra libera di scorrere.
- È possibile usare la GI-GI in combinazione con un autobloccante e un pedale per risalite di emergenza.



#859SET001KK
Gi-Gi Set

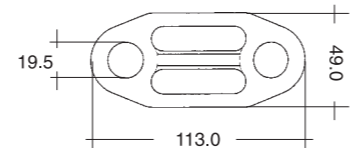

#	Standards	Material	Color	g	Ø mm min.	Ø mm max.
859B00400KK	-	alu alloy	Blue	68	8	13
859N00400KK	-	alu alloy	Black	68	8	13
859Y00400KK	-	alu alloy	Yellow	68	8	13
859P00100KK	-	alu alloy	Grey	68	8	13
859F00400KK	-	alu alloy	Dark Grey	68	8	13



FUTURA SYSTEM

- A revolution in the rope clamp world for its extremely tiny dimensions and ergonomic shapes.
- It's the natural marriage between three devices and the best system for ascending a rope. The "ROPE WALKING SYSTEM" is like climbing a ladder.
- After testing the system, users confirm excellent performance and a 30% efficiency gain during ascent.
- Una rivoluzione nel campo dei bloccanti, dimensioni ridotte ed ergonomia sorprendente.
- È il logico connubio di tre attrezzi migliorativi che permette di procedere con un'estrema facilità nella tecnica "alternata", come se si fosse su una scala a pioli!
- Test condotti da tecnici confermano un guadagno minimo del 30% dell'efficacia di risalita.



FUTURA HAND



FUTURA BODY



FUTURA FOOT WORK

FUTURA HAND

NEW

- Its small size allows the user to comfortably hold the device close to the rope, in the same way you would grab a rope but much more comfortably. It comes with two different sized handles for ergonomic customization. Available in right and left versions.
- La presa anteriore rispetto alla corda, dona maneggevolezza e sicurezza. Fornita con due impugnature intercambiabili, di differenti misure. Disponibile nella versione per mano destra e sinistra.

New colors!
Nuovi colori!

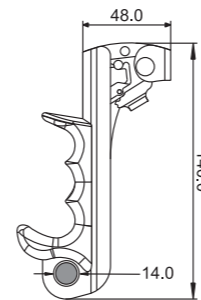

#	Standards	Material	Color	g	Ø mm min.	Ø mm max.
87600N4SKK (left)	• EN 12841/B	alu alloy		125	8	12
87600N04DKK (right)	• EN 12841/B	alu alloy		125	8	12

FUTURA BODY

NEW

- Chest ascender, incredibly reduced size and weight, only 80g!
- Bloccante ventrale di dimensioni e peso incredibilmente ridotti, solo 80g!

New colors!
Nuovi colori!

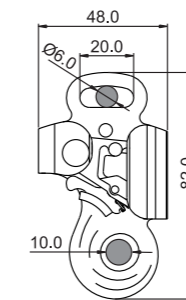

#	Standards	Material	Color	g	Ø mm min.	Ø mm max.
94200N000KK	• EN 567 EN 12841/B	alu alloy		80	9	11

FUTURA FOOT WORK

NEW

- Foot ascender that improves and completes the performance of the Futura Hand ascender and Futura Body chest ascender.
- New version with lever that prevents accidental release of the rope.
- Available in right and left versions, equipped with anti-torsion stirrup.
- Available without lever.
- Bloccante supplementare da piede, che migliora e completa le prestazioni della maniglia Futura Hand e del bloccante ventrale Futura Body.
- Nuova versione con cricchetto che evita la fuoriuscita accidentale della corda.
- Disponibile in versione destra e sinistra, dotato di staffa anti-torsione.
- Disponibile anche senza cricchetto.



FUTURA FOOT
87609F04DKK
87609N04SKK

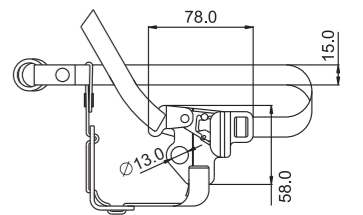

#	Standards	Material	Color	g	Ø mm min.	Ø mm max.
87609O06DKK (right)	-	alu alloy		135	8	12
87609N06SKK (left)	-	alu alloy		135	8	12

DUCK

- Duck, the innovative emergency rope clamp. Conceived for single ropes with a diameter between 8 and 13 mm, Duck is the first and only clamp that also works on flat and tubular slings from 10 to 15 mm width (even if these are not certified for progression).
- Due to its small dimensions, it can be easily attached with one hand. The big hole allows locking connectors to rotate. Duck was born as an emergency rope clamp for retrieval, progression manoeuvres and for the regulation of daisy chains.
- Innovativo bloccante d'emergenza. Concepito per corde singole di diametro compreso tra 8 e 13mm, il Duck è il primo bloccante al mondo in grado di funzionare anche su fettucce piane e tubolari da 10 a 15 mm di larghezza (benchè queste - è risaputo - non siano omologate per la progressione).
- Di dimensioni assai ridotte, è facile da inserire anche con una sola mano. Inoltre l'ampio foro d'attacco permette la rotazione anche dei moschettoni a ghiera. Duck nasce come bloccante d'emergenza utile in manovre di recupero, autosoccorso, progressione in conserva e come regolatore per longe o daisy in fettuccia.

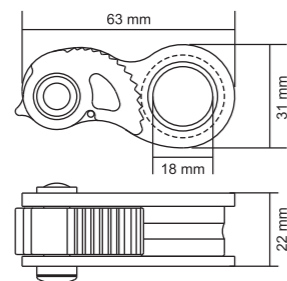

#	Standards	Material	Color	g	min.	max.
88800DB00KK	• EN 567	alu alloy	Blue/Black	70	8	13
88800NR00KK	• EN 567	alu alloy	Red/Black	70	8	13
88800NG00KK	• EN 567	alu alloy	Green/Black	70	8	13
88800NN00KK	• EN 567	alu alloy	Black	70	8	13

CAM-CLEAN

- Chest rope clamp specifically conceived for climbing, caving, rescue, work at height, canyoning.
- All the components are part of the latest generation of Kong blockers. Excellent ability to lock on muddy and icy ropes thanks to the holes in the cam. The new material and a special chemical and thermal process give the cam a much higher surface hardness in addition to the black color. The result is great wear resistance and a reduction of the fragility that usually occurs by quenching steel to low temperatures. New opening lever which is ergonomic, easy to handle and protected from shocks and the risk of accidental opening.
- Bloccante ventrale di dimensioni ridotte, studiato per la speleologia e per tutte le applicazioni di derivazione speleologica quali soccorso, soccorso in forra, lavori in altezza, canyoning.
- Utilizza tutta la componentistica di ultima generazione dei bloccanti Kong. Ottima la capacità di bloccare su corde particolarmente infangate grazie alle asole di svuotamento presenti sulla camma. Il nuovo materiale ed uno speciale procedimento termico e chimico conferiscono alla camma dentata, oltre al colore nero, una durezza superficiale molto superiore. Il risultato è una grande resistenza all'usura ed una riduzione della fragilità che solitamente penalizza gli acciai da tempratura alle basse temperature. Nuovo il clicchetto d'apertura, ergonomico, facile da manovrare e molto protetto dagli urti e dal rischio di aperture accidentali.

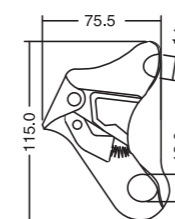

#	Standards	Material	Color	g	min.	max.
82400N400KK	• EN 567 EN 12841/B	alu alloy	Black	150	8	13
82400O400KK	• EN 567 EN 12841/B	alu alloy	Orange	150	8	13
82400R400KK	• EN 567 EN 12841/B	alu alloy	Red	150	8	13
82400B400KK	• EN 567 EN 12841/B	alu alloy	Blue	150	8	13

MODULAR

- Multiuse rope clamp specifically conceived for climbing, caving, rescue, work at height, canyoning, etc.
- Bloccante multiuso di dimensioni ridotte, studiato per la speleologia e per tutte le applicazioni di derivazione speleologica quali soccorso, soccorso in forra, lavori in altezza, canyoning etc.

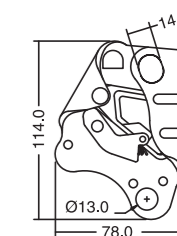

#	Standards	Material	Color	g	min.	max.
875R04D00KK (right)	• -	alu alloy	Red	170	8	13
875B04S00KK (left)	• -	alu alloy	Blue	170	8	13
875N04S00KK (left)	• -	alu alloy	Black	170	8	13
875N04D00KK (right)	• -	alu alloy	Black	170	8	13

LIFT

- Rope clamp for rope access, available in left and right versions. All the components are part of the latest generation of Kong blockers. Excellent locking ability particularly on muddy and icy ropes thanks to the holes in the cam and on the side plate. The new material and a special chemical and thermal process give the cam a much higher surface hardness in addition to the black color. The result is great wear resistance and a reduction of the fragility that usually occurs by quenching steel to low temperatures. New opening lever which is ergonomic, easy to handle and protected from shocks and the risk of accidental opening.
- Bloccante mobile per risalita, disponibile in versione destro e sinistro. Utilizza tutta la componentistica di ultima generazione dei bloccanti Kong. Ottima la capacità di bloccare su corde particolarmente infangate grazie alle asole di svuotamento presenti non solo sulla camma ma anche sulla guancia. Il nuovo materiale ed uno speciale procedimento termico e chimico conferiscono alla camma dentata, oltre al colore nero, una durezza superficiale molto superiore. Il risultato è una grande resistenza all'usura ed una riduzione della fragilità che solitamente penalizza gli acciai da tempra alle basse temperature. Nuovo il clicchetto d'apertura, ergonomico, facile da manovrare e molto protetto dagli urti e dal rischio di aperture accidentali.

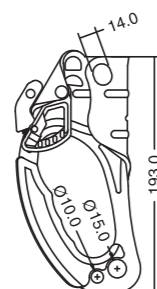

#	Standards	Material	Color	g	min.	max.
896D04S00KK (left)	EN 567 EN 12841/B	alu alloy	Grey	225	8	13
896NN4S00KK (left)	EN 567 EN 12841/B	alu alloy	Black	225	8	13
896B04S00KK (left)	EN 567 EN 12841/B	alu alloy	Blue	225	8	13
896B04D00KK (right)	EN 567 EN 12841/B	alu alloy	Light Blue	225	8	13
896O04D00KK (right)	EN 567 EN 12841/B	alu alloy	Orange	225	8	13
896R04D00KK (right)	EN 567 EN 12841/B	alu alloy	Red	225	8	13
896NN4D00KK (right)	EN 567 EN 12841/B	alu alloy	Black	225	8	13

SLING ASCENDER

- Adjustable stirrup (from 90 to 120 cm) made of strong nylon sling.
- Used with a rope clamp ascender, it aids progression on rope.
- Staffa / Pedale regolabile (da 90 a 120 cm) realizzata in resistente fettuccia di nylon.
- Utilizzata in abbinamento ad una maniglia di risalita agevola la progressione su corda.

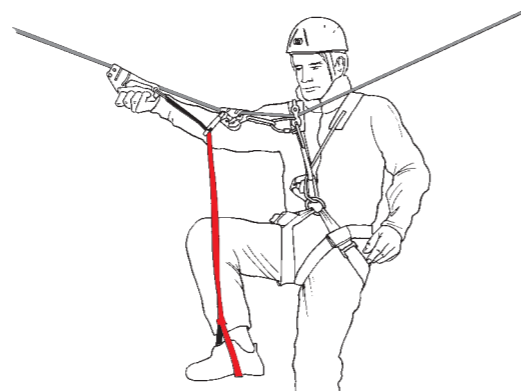

#	Material	g
834120300KK	polyamide	90

BASEL

NEW

- Textile stirrup composed of four steps, designed to help during progression and rope and to facilitate technical passages in work at height.
- It can also be used for aid climbing and during caving ascents.
- Upper and lower attachment points reinforced with protective sheath.
- The lower attachment point allows to connect several brackets in series.
- Reinforcement on every single step that keeps the buttonhole open and facilitates the insertion of the foot.
- Additional top buttonhole used as a handle to lift up.
- The double step at the base allows you to couple your feet and take a rest position by relieving the compressions due to the use of the harness.
- **WARNING: it is not a PPE.**
- Staffa tessile composta da quattro scalini, ideata come ausilio alla progressione e per facilitare passaggi tecnici nel lavoro in quota.
- Utilizzabile anche per passaggi in artificiale e durante le risalite speleo.
- Punti di attacco superiore e inferiore rinforzati con guaina protettiva.
- Il punto di attacco inferiore permette di agganciare in serie più staffe.
- Rinforzo su ogni singolo gradino che mantiene aperta l'asola e facilita l'inserimento del piede.
- Asola superiore supplementare utilizzabile come maniglia per sollevarsi.
- Il doppio gradino alla base permette di accoppiare i piedi e assumere una posizione di riposo alleggerendo le compressioni dovute all'uso dell'imbragatura.
- **ATTENZIONE: non è un DPI.**



#	Material	Color	g
834010000KK	polyamide	Black/Orange	245

HELP

- Multi-purpose adjustable stirrup, super compact and lightweight, contained in a handy bag which can be clipped to the harness. Simply open the Velcro flap in order to free the stirrup and it is ready to use. Very useful in resting situations, during recovery of the second climber and in aid climbing in general. Great for budding climbing photographers!
- Made with 3 mm aramid cord and equipped with a length adjustment buckle and stiff pedal made of ultra-durable nylon.
- Staffa multiuso regolabile, compatta e leggera, contenuta in un pratico sacchetto agganciabile all'imbrago. È sufficiente aprire la patella in Velcro per liberare la staffa e renderla pronta all'uso. Molto utile in situazioni di sosta, di recupero del secondo di cordata e in generale in arrampicata artificiale.
- Realizzata con cordino aramidico da 3 mm e dotata di pedale e fibbia di regolazione in nylon ultra-resistente.



#	Material	g
834001000KK	mixed	110

SPELEO STAIR

- Ladder fitted with two supporting cables made of galvanized steel with a diameter of 2.50 mm - 49 threads - with rungs made of tubular aluminum 6060 T6, dimensions 20.5x16x210 mm fixed by pressing to the cable at distances of 30 cm.
- The first and last step are protected by heat shrink. The length of the ladder shall be measured from thimble to thimble (general tolerance dimensions +/- 5%).
- Tensile strength: 8 kN
- Load of the tubular aluminum kN > 8 kN
- SWL 1: 5 - 1.6 kN
- Available in 3 sizes: 5, 10 and 20 m
- Other sizes available on request.
- On request it is available with black rungs.
- Scaletta speleo costituita da 2 cavi portanti in acciaio zincato del diametro di 2,50 mm 49 fili e scalini costituiti da tubolari in alluminio 6060 T6 della misura di 20.5x16x210 mm bloccati per schiacciamento sul cavo alla distanza tra loro di cm 30. I terminali del cavo sono piombati con due manicotti in alluminio e con redancia in inox a circa 17/18 cm dal primo e ultimo scalino protetti da guaina termoretraibile. I metri di lunghezza della scaletta sono da intendersi da REDANCIA a REDANCIA (tolleranza generale dimensioni +/- 5%).
- Carico a rottura: 8 kN
- Carico di bloccaggio del tubolare in alluminio: kN > 8 kN
- Carico di utilizzo: SWL 1:5 - 1.6 kN
- Disponibile in 3 misure: 5, 10 e 20 m
- Altre misure disponibili a richiesta.
- Su richiesta è disponibile la versione con pioli neri.



#	Standards	Material	g
970050000KK	-	alu alloy zinc plated steel	900
970100000KK	-	alu alloy zinc plated steel	1600
970200000KK	-	alu alloy zinc plated steel	3100



Reflex Extra Roll Twin Mini Twin Evo Turbo Roll Swing Block Roll Futura Mini Block Zip Evo Pamir Fast

REFLEX

- Aluminum pulley with single wheel, mobile side plates and high efficiency (96%) ball bearing.
- Equipped with two attachment points for use in complex lifting systems.
- Carrucola in alluminio con puleggia singola a flange mobili e cuscinetti a sfera ad alta efficienza (96%).
- Dotata di due punti di attacco per l'utilizzo nei sistemi di sollevamento complessi.

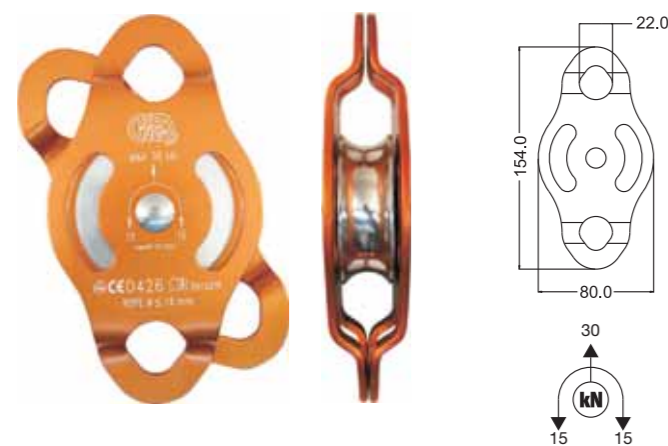

EXTRA ROLL

- Aluminum pulley with single wheel, mobile side plates and high efficiency (96%) ball bearing.
- Equipped with two attachment points for use in complex lifting systems.
- Carrucola in alluminio con puleggia singola a flange mobili e cuscinetti a sfera ad alta efficienza (96%).



TWIN

- Aluminum pulley with double wheel, mobile side plates and high efficiency (96%) ball bearing.
- Equipped with two attachment points for use in complex lifting systems.
- Carrucola in alluminio con doppia puleggia a flange mobili e cuscinetti a sfera ad alta efficienza (96%).
- Dotata di due punti di attacco per l'utilizzo nei sistemi di sollevamento complessi.

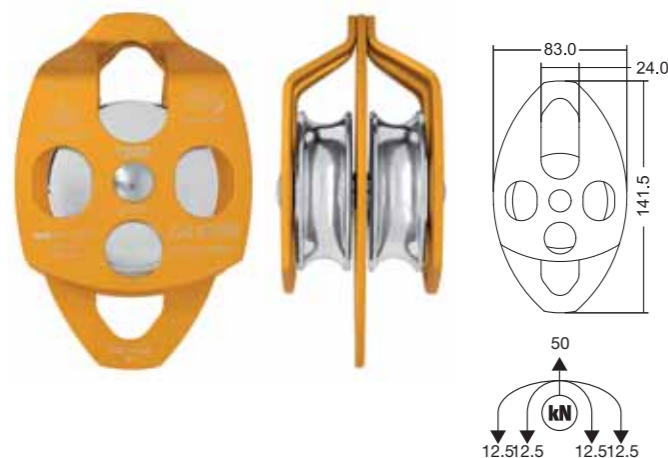

MINI TWIN EVO

- Compact aluminum pulley with double wheel, mobile side plates and high efficiency (91%) ball bearing.
- Equipped with two attachment points for use in complex lifting systems.
- Carrucola compatta in alluminio con doppia puleggia a flange mobili e cuscinetti a sfera ad alta efficienza (91%).
- Dotata di due punti di attacco per l'utilizzo nei sistemi di sollevamento complessi.



TURBO ROLL

- Compact and lightweight pulley with fixed side plates, aluminum body and ball bearing to ensure optimum efficiency.
- Nylon wheel.
- For ropes up to 11 mm diameter.
- The secondary attachment point on the lower part of the body is "Textile Friendly"
- Carrucola compatta e leggera a flange fisse con corpo in alluminio e cuscinetto a sfera per garantire un ottimo rendimento.
- Puleggia in Nylon.
- Per corde di diametro max 11 mm.
- Il punto di attacco secondario sulla parte inferiore del corpo è "Textile Friendly"



SWING

- Compact pulley with mobile side plates.
- Available in 2 versions:
 - Aluminum side plates, nylon wheel and ball bearing
 - Stainless steel side plates, nylon wheel and bush
- For ropes up to 11 mm diameter.
- Carrucola compatta a flange mobili.
- Disponibile in 2 versioni:
 - flange in alluminio, puleggia in Nylon e cuscinetto a sfera
 - flange in acciaio inox, puleggia in Nylon e bronzina
- Per corde di diametro max 11 mm.

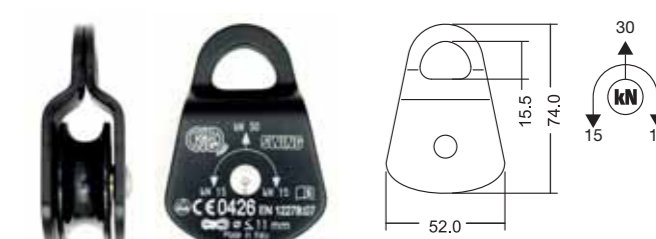

Available in carbon steel # 992 and Stainless steel # 994.
Disponibile in acciaio # 992 e acciaio inox # 994.

#	CE	Standards	Color	Body material	Wheel material	Efficiency %	g	kN	Ball bearing	Bush	Ø mm max.
REFLEX											
82900OP00KK	•	EN 12278	■	alu alloy	alu alloy	96	270	26	•		13
EXTRA ROLL											
82000OP00KK	•	EN 12278	■	alu alloy	alu alloy	96	245	30	•		13
82001PN00KK	•	EN 12278	■	alu alloy	nylon	96	245	30	•		13
TWIN											
82700OP00KK	•	EN 12278	■	alu alloy	alu alloy	96	490	50	•		13
MINI TWIN EVO											
94500OP00KK	•	EN 12278:07	■	alu alloy	alu alloy	91	171	32	•		13

#	CE	Standards	Color	Body material	Wheel material	Efficiency %	g	kN	Ball bearing	Bush	Ø mm max.
TURBO ROLL											
82100ON00KK	•	EN 12278	■	alu alloy	nylon	93	65	26	•		11
SWING											
993P00100KK	•	EN 12278	■	alu alloy	nylon	87	120	30	•		11
993N00400KK	•	EN 12278	■	alu alloy	nylon	87	120	30	•		11
994000000KK	•	-	■	stainless steel	nylon	87	120	30	•		11

BLOCK ROLL

- The Block Roll is a single sheave aluminum pulley with ball bearings and auto-block. It works with ropes up to 12mm.
- Carrucola in alluminio con puleggia singola e auto-bloccante. Per corde di diametro max 12mm.

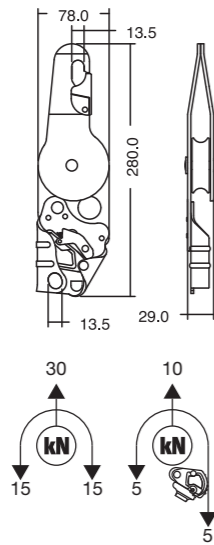

FUTURA MINI BLOCK

- Low friction pulley fitted with a locking device that can be engaged and disengaged through the special pawl. Compact and lightweight, conceived for mountaineering and rescue. Properly used in recovery, it becomes fundamental for the preparation of simple or double hoists in rescue and self rescue. Miniblock belongs to the ultra compact "Futura" family of blockers, which can be used in case of emergency and for climbing.
- Carrucola a basso attrito con bloccante inseribile e desinseribile tramite clicchetto, compatta e leggera concepita per alpinismo e soccorso. E' adatta nel recupero di materiali in parete e diventa fondamentale nell'allestimento di paranchi semplici o doppi da soccorso od autosoccorso. Miniblock fa parte della famiglia di bloccanti ultracompatti 'Futura' di cui conserva la geometria ed alcuni particolari. Può essere utilizzato anche in caso di emergenza come bloccante per la risalita.



Only 165 g!
Solo 165 g!

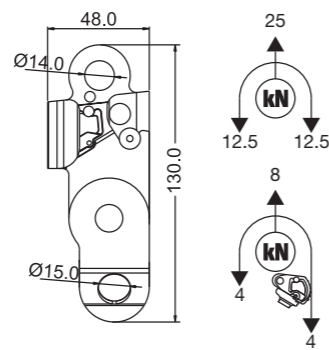

ZIP EVO (ZIP CAP INCLUDED)

- Evolution of the first pulley with an integrated connector which eliminates any possibility of error. Improved handle ergonomics and simplicity of use thanks to the new lever which can be opened with one hand. The special design ensures correct positioning on the rope in any situation.
- Equipped with ball bearings for perfect smooth rolling. It works on both ropes and metal cables up to 13 mm in diameter.
- Available in a version with a hook for hanging connectors, avoiding the wear caused by allowing the connectors to slide along the metal cable (#826.05).
- It can be carried on the harness using the ingenious Clack! magnetic system (#223).
- Evoluzione della prima carrucola con connettore integrato che elimina qualunque possibilità di errore. Migliorata l'ergonomia dell'impugnatura e la semplicità di utilizzo grazie alla nuova leva apribile con una mano sola. Il particolare design garantisce il corretto posizionamento sulla corda in qualsiasi situazione.
- Dotata di cuscinetti a sfera per una perfetta fluidità di scorrimento. Funziona sia su corde che su cavi metallici fino a 13 mm di diametro.
- Disponibile in versione con gancio per la sospensione dei connettori, evitando l'usura causata dallo scorrimento sul cavo metallico (#826.05).
- Può essere fissata all'imbrago tramite l'ingegnoso sistema a magneti (Clack! #223).

EN 17109



CLACK

22300000KK

- Magnetic holster for harness.
- Supporto magnetico da imbracatura.



ZIP EVO HOOK

826050400KK

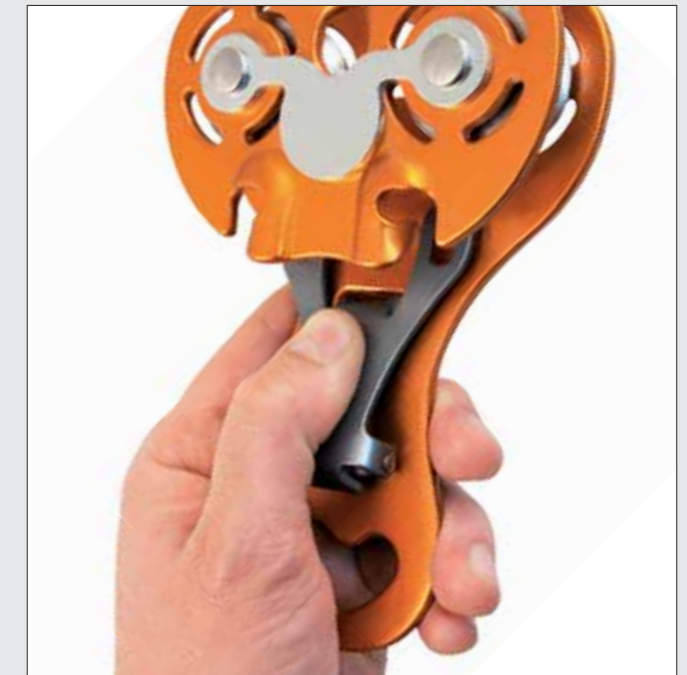

#	Standards	Color	Body material	Wheel material	Efficiency %	g	kN	Ball bearing	Bush	Ø mm max.
BLOCK ROLL										
81800N000KK	EN 12278	Orange/Black	alu alloy	alu alloy	-	550	28	•		13
FUTURA MINI BLOCK										
94400N000KK	EN 12278	Orange/Black	alu alloy	alu alloy	-	165	28	•		12

#	Standards	Color	Body material	Wheel material	Efficiency %	g	kN	Ball bearing	Bush	Ø mm max.
ZIP EVO										
826040400KK	EN 12278 - EN 17109 - RfU CNB/P/11.10	Orange	alu alloy	steel	95	390	22	•		13
ZIP EVO HOOK										
826050400KK	EN 12278 - EN 17109 - RfU CNB/P/11.104	Orange	alu alloy	steel	95	390	22	•		13

PAMIR FAST

- The Pamir Fast is a double sheave pulley with aluminum side plates, ball bearings and nylon wheels. It works with ropes up to 13mm.
- Suggested for zip line in adventure parks, it can be used also for double hoists in rescue and work situations.
- Carrucola con corpo in alluminio e doppia puleggia in acciaio. Utilizzo su corde o cavi d'acciaio di diametro massimo 13 mm.
- Consigliata per tyrolienne in parchi avventura, utile per creare paranchi doppi da soccorso o da lavoro.

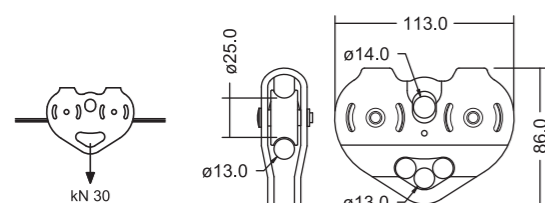

#	CE	Standards	Color	Body material	Wheel material	Efficiency %	g	kN	Ball bearing	Bush	Ø mm max.
PAMIR FAST											
946004400KK	•	EN 12278 - EN 17109	■	alu alloy	steel	-	365	30	•		13
94600N400KK	•	EN 12278 - EN 17109	■	alu alloy	steel	-	365	30	•		13
ZIP CAP											
826060000KK	-	-	■	plastic	-	-	27	-			-

ZIP CAP

- All our double pulleys mod. PAMIR, ZIP EVO and EVO ZIP HOOK can be equipped with a top protection made of nylon that prevent the user can come into contact with the rotating elements of the pulleys (as required by the norm FprEN 17109).
- The protection can be applied and removed easily without the need for any tools.
- No changes has been made on the bodies of the pulleys, so the protection is applicable to any specimen of PAMIR, ZIP EVO and ZIP EVO HOOK, also produced before 2017.
- Le nostre carrucole doppie PAMIR, ZIP EVO e ZIP EVO HOOK possono essere dotate di una protezione superiore realizzata in Nylon per evitare che l'utente possa entrare in contatto con gli elementi rotanti delle pulegge (come previsto dalla norma FprEN 17109).
- La protezione si applica e si rimuove facilmente senza la necessità di alcun attrezzo.
- Nessuna modifica è stata effettuata sui corpi delle carrucole e quindi la protezione è applicabile a qualunque esemplare di PAMIR, ZIP EVO e ZIP EVO HOOK, anche prodotti antecedenti il 2017.



Ph: Kong Archive



MEDALE

- Via Ferrata set made with 20 mm tubular webbing lanyards with inner elastic and Tango alu alloy connectors with double gate safety system.
- Fitted with high strength stitching and an energy absorber housed in a bag with zip for easy inspection.
- Conforms to the safety requirements of the new revision of EN 958:2017, which includes a load between 40 and 120 kg.
- Total length of the set: min. 85 cm - max. 120 cm.
- Set da ferrata a Y realizzato con fettuccia elastica da 20 mm e connettori Tango a doppia leva di sicurezza. Dotato di cuciture ad alto carico e dissipatore facilmente ispezionabile grazie alla pratica custodia con zip. Conforme ai requisiti di sicurezza previsti dalla nuova revisione della norma EN 958:2017 che prevede un carico d'uso compreso tra 40 e 120 kg.
- Lunghezza totale del set: min. 85 cm - max. 120 cm.

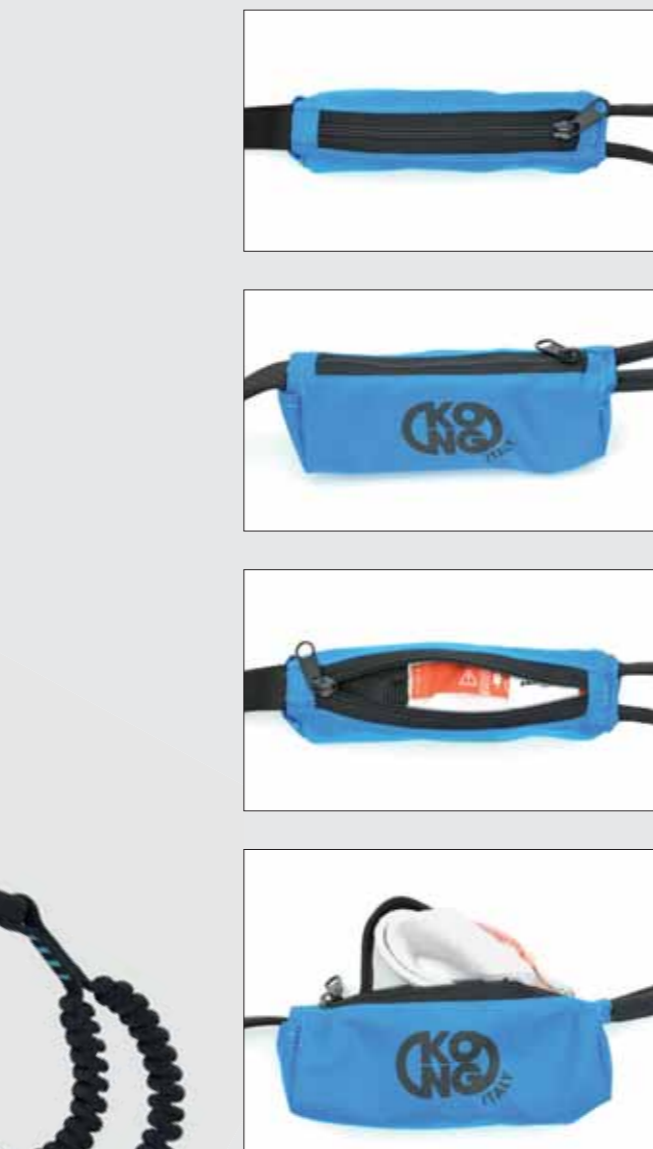

#	UAA	Standards	Material	g
811SET071KK	•	EN 958:2017	elastic arms	550

KISA KONG IMPACT SHOCK ABSORBER

- Through controlled rope slippage, energy dissipators reduce the impact caused by an accidental fall. The KISA (Kong Impact Shock Absorber) dissipator allows use of two different rope diameters, inserted in different openings, with the purpose of obtaining various degrees of friction and paying out. The user must decide for him/herself which is the most suitable way to use the equipment and the length of rope to be paid out. The most correct set-up may vary according to the weight of the user and the various types and conditions of the rope. Remember that wet ropes do not slide so quickly.
- I dissipatori di energia assorbono gradualmente lo strappo causato da una caduta grazie allo scorrimento frenato della corda nell'attrezzo. Il dissipatore KISA (Kong Impact Shock Absorber) consente l'uso di due diversi diametri della corda, inserita in fori diversi, allo scopo d'ottenere differenti gradi d'attrito e di scorrimento. L'utilizzatore dovrà determinare, con attenzione, l'uso più appropriato dell'attrezzo e la lunghezza della corda da far scorrere. Gli assetti più appropriati possono variare in funzione del proprio peso e dei diversi tipi e delle differenti condizioni della corda. Con corde bagnate lo scorrimento è minore.
- KISA può essere utilizzato anche per aumentare la sicurezza di punti di assicurazione (moschettoni, piastre, chiodi) in situazioni/posizioni critiche.



Watch the video
Guarda il video

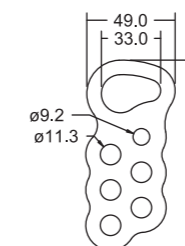

#	Standards	Material	Color	g
80606B400KK	-	aluminium	■	330
80606N400KK	-	aluminium	■	330

	mm	IMPACT FORCE kg	SLIDING cm
	Ø 11 ● UIAA	400÷500	100÷150
	Ø 11 ● UIAA	150÷300	≥ 200
	Ø 9 ● UIAA	300÷400	150÷200
	Ø 9 ● UIAA	150÷300	≥ 300

KASC KLETTERSTEIG ANTI SHOCK CONE

- KASC is a kit conceived to improve safety on "Via ferrata". It is made of thermoplastic rubber and can withstand extreme temperatures (-40° +90°). In case of a fall, KASC absorbs the impact on the fixed bolt and encourages the connector to position itself along the right load bearing line, reducing lateral/torsional forces. Easy to install by screwing the two bolts-nuts supplied (warning: don't over tighten!). The four flexible inner fins keep KASC in position on cables/chains up to 30mm Ø. It can be glued. On request, there is room (35x25 mm) for advertising or sponsorship information.
- KASC è un kit concepito per aumentare la sicurezza delle "vie ferrate". È realizzato in gomma termoplastica in grado di resistere a temperature estreme (-40° +90°). In caso di caduta, KASC attutisce l'impatto del connettore sul supporto fisso, aiutandolo a posizionarsi secondo la migliore linea di carico e riducendo quindi le tensioni laterali/torsionali. Si installa semplicemente avvitando le due viti in dotazione (attenzione: non stringere troppo!). Le quattro alette flessibili interne permettono di mantenere KASC in posizione su cavi e catene fino a 30mm di diametro. Può essere incollato con una goccia di colla. È predisposto inoltre uno spazio personalizzabile (35x25 mm) per inserire una eventuale pubblicità o sponsorizzazione.



#	Color	Material	g	kN	mm	Ø mm
8983S0000KK	■	rubber	350	-	-	-

ANCHORING TOOLS ANCORAGGI

10



Dancer



Anchor Kit



Resting Fiffi



Slyde



Owl



Speleagle

DANCER

- Aluminum swivel, prevents ropes from twisting during load suspension.
- Fluid movement through the ball bearing.
- High tensile strength, 42 kN!
- Certified to CE EN 354.
- Girello in alluminio che evita l'attorcigliamento della corda durante la sospensione di un carico.
- Movimento fluido grazie al cuscinetto a sfera.
- Alto carico di rottura, ben 42 kN!
- Certificazione: CE EN 354.

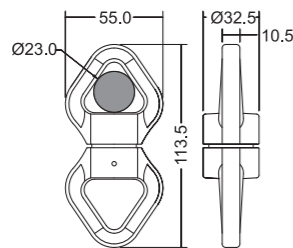

Ball bearing.
Cuscinetto a sfera.

WIDE EYE

- Anchor plate, made of high quality stainless steel AISI 304 and weather resistant.
- Certified to EN 795/B.
- For rescue and work at height.
- Available in 2 sizes.
- Available also as an anchoring kit composed of an anchor plate and an expansion bolt certified to EN 959.
- Piastrina di ancoraggio in acciaio inossidabile AISI 304 di alta qualità resistente agli agenti atmosferici.
- Certificata EN 795/B.
- Per soccorso e lavori in quota.
- Disponibile in 2 misure.
- Disponibile anche kit composto da piastrina + tassello ad espansione certificato EN 959.

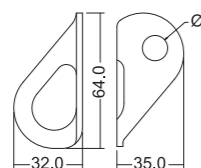

#	Standards	Color	Material				
				g	kN	mm	mm
DANCER							
948ON0400KK	RFU PPE-R/11.135		alu alloy	160	42	113,5	23
WIDE EYE							
897100001KK	EN 795/A		stainless steel AISI 316	46	-	-	8
897120001KK	EN 795/A		stainless steel AISI 316	44	-	-	10

FIX

- Stainless steel expansion bolt, to be used in combination with the Wide Eye plate.
- Available in three sizes (60 x 10 mm, 90 mm and 100 x 10 x 12 mm).
- High quality product, resistant to corrosion.
- Tassello ad espansione in acciaio inox, da utilizzare in abbinamento alla piastrina mod. Wide Eye.
- Disponibile in tre misure (60 x 10 mm, 90 x 10 mm e 100 x 12 mm).
- Prodotto di alta qualità, resistente alle intemperie e alla corrosione.



ANCHOR KIT

- Stainless steel anchor kit composed of an expansion bolt and fixed hanger.
- For mountaineering, rock climbing, rescue and work at height.
- Available in 3 sizes.
- High quality, made of stainless steel and weather resistant.
- Kit di ancoraggio in acciaio inossidabile composto da un tassello ad espansione ed una placchetta d'ancoraggio.
- Per alpinismo, arrampicata su roccia, soccorso e lavori in quota.
- Disponibile in 3 misure.
- Alta qualità, realizzato in acciaio inox resistente agli agenti atmosferici.



#	Standards	Color	Material				
				g	kN	mm	mm
FIX							
814106000KK	-		stainless steel AISI 304	44	-	60	10
814121000KK	-		stainless steel AISI 304	100	-	100	12
814107000KK	-		stainless steel AISI 316	45	-	70	10
814129000KK	-		stainless steel AISI 316	85	-	90	12
ANCHOR KIT							
836070000KK	• EN 959		stainless steel AISI 316	92	-	70	-
836080000KK	• EN 959		stainless steel AISI 316	132	-	90	-

RESTING FIFFI

- Ingenious alu alloy hook for aid climbing and progression. Resting Fiffi allows you to adjust the lanyard length and is self-locking.
- Use with 7 mm static rope. Only for static loads!
- The upper hole is for the insertion of a lanyard and allows recovery from above.
- Ingegnoso gancio in lega leggera per sosta, artificiale e staffe. Permette di regolare la lunghezza del cordino ed è autobloccante.
- Utilizzare con cordino statico di 7 mm. Solo per carichi statici!
- Con il Resting Fiffi la vostra staffa può essere anche di un solo gradino. Il foro superiore permette l'inserimento di un cordino per recupero dall'alto.

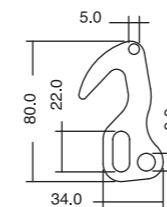

FIFFI

- Hook for positioning, progression and haul bag retrieval.
- Lower carabiner hole for connecting a lanyard, stirrup, or haul bag.
- Made of carbon steel.
- Gancio per il posizionamento, la progressione e il sollevamento di carichi.
- Foro di moschettonaggio inferiore per collegare una longe, delle staffe o un sacco.
- Realizzato in acciaio al carbonio.



#	Color	Material				
			g	kN	mm	mm
RESTING FIFFI						
803R00400KK		alu alloy	15	-	80	7
803B00400KK		alu alloy	15	-	80	7
803F00400KK		alu alloy	15	-	80	7
803P00100KK		alu alloy	15	-	80	7
FIFFI						
803010Z00KK		carbon steel	38	-	73	-

SLYDE

- The Slyde self-locking plate may also be used to reduce the impact force of a fall, by acting as a shock absorber (even though it was not designed to be an "energy dissipator").
- Slyde is ordinarily used as an adjustable longe.
- Piastra multifunzione per alpinismo, climbing, speleologia.
- La piastrina autobloccante Slyde, pur non essendo nata come "dissipatore d'energia", può essere utilizzata per ridurre la forza d'impatto in caso di caduta, con un'azione ammortizzatrice.
- Slyde è abitualmente utilizzata come regolatore di longe. Per accorciare la longe, scaricare il peso e tirare la corda in uscita.

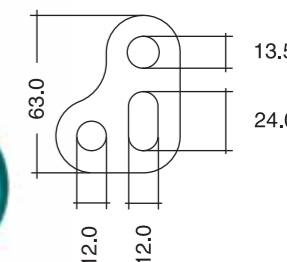

Watch the video
Guarda il video

#	Color	Material				
			g	kN	mm	mm
SLYDE						
856B00200KK		alu alloy	44	-	63	9

OWL

- Gear holder for mountaineering and climbing.
- It allows you to have easy and convenient access to materials such as pitons, nuts, friends ...
- Two mini connectors mod. 'Mini Pear' included.
- Portamateriale per alpinismo e arrampicata.
- Ti consente di avere facile e comodo accesso a materiali quali chiodi, nuts, friends..
- Due mini connettori 'Mini Pear' inclusi.

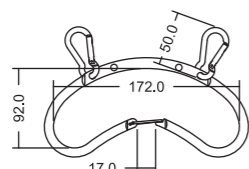

TRIK

- Multifunction tool made of light aluminum alloy.
- Mainly used to extract nuts, Trik is also equipped with wrench sizes 8 and 17 mm, and a handy bottle opener.
- Fitted with a wire gate for hanging it to the harness.
- Attrezzo multifunzione realizzato in lega leggera d'alluminio.
- Principalmente utilizzato come estrattore di nuts, Trik è anche dotato di chiavi inglesi per dadi da 8 e 17 mm e di un comodo apribottiglia.
- Con leva a filo per agganciarlo all'imbrago e renderlo imperdibile.

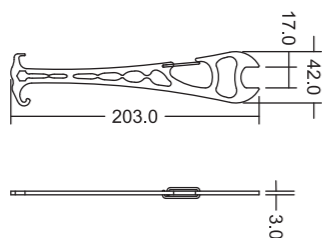

#	Color	Material	g
OWL			
920SET0100K	■	alu alloy	68
TRIK			
921R00400KK	■	alu alloy	22

EAGLE LIGHT

- Classic hammer designed for mountaineering, caving and rescue. Design developed in collaboration with the famous climber Jim Bridwell.
- Made with a steel striking head and wooden handle that provides excellent vibration absorption and maximum comfort of use.
- Equipped with tape to attach it to your harness and avoid the chance of dropping.
- Available in two versions, standard (Eagle) and light (Eagle Light).
- Martello classico concepito per alpinismo, speleologia e soccorso. Design realizzato in collaborazione al famoso climber Jim Bridwell.
- Realizzato con testa battente in acciaio e manico in legno che garantisce un ottimo assorbimento delle vibrazioni e il massimo confort d'utilizzo.
- Dotato di fettuccia per legarlo all'imbrago e renderlo imperdibile.
- Disponibile in due versioni, standard (Eagle) e alleggerita (Eagle Light).



#	Material	g
998020000KK	carbon steel / wood	700

SPELEAGLE

- Innovative compact stainless steel hammer with a lightweight head, specifically designed for mountaineering, caving, rescue and equipping.
- It can be used to tighten 13 and 17mm nuts.
- Fitted with an ergonomic rubber handle and 10mm tape for safe handling.
- Awarded the 2009 Industry Award winner.
- The compact size makes it perfect for equipping in caving situations.
- Innovativo martello con testa battente alleggerita, in acciaio inox concepito per alpinismo, speleologia e soccorso.
- Dotato di chiavi da 13 e 17mm per serrare le viti.
- Impugnatura ergonomica in gomma e fettuccia da 10mm per evitare la perdita accidentale.
- Premiato all'Industry Award del 2009.
- Le dimensioni compatte lo rendono perfetto per lavori di chiodatura in speleologia.

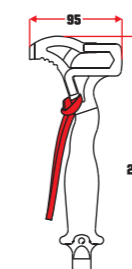

#	Material	g
998100000KK	rubber / zinc plated steel	570



SPELEAGLE



Soul



Dhino



Lys



Rutor



Trix Carbon



Rox



Grodal

Soul

only good vibrations

SOUL

- Soul, an ice axe with a spirit, an ice axe that does not attack the ice but penetrates it efficiently without transmitting bad vibrations on the arms.
- A product that incorporates the best traditions reinterpreted in a modern way, mixing wood and light aluminum alloy, tradition and innovation, nature and technology.
- The surprising efficiency of this tool will amaze you, try it.
- Interchangeable steel blade.
- Wooden core (Iroko) that stops any vibrations.
- Alu alloy side plates guarantee strength and lightness.
- Optional hammer, easy to assemble # 885010000KK.
- Soul, una piccozza con l'anima, una piccozza che non aggredisce il ghiaccio ma che lo penetra in maniera efficiente senza trasmettere fastidiose vibrazioni sulle braccia.
- Un prodotto che riprende il meglio della tradizione e la reinterpreta in chiave moderna, mescolando legno e lega d'alluminio, tradizione e innovazione, natura e tecnica.
- La sorprendente efficacia di questo strumento vi stupirà, provatela.
- Lama intercambiabile.
- Anima in legno (Iroko) che assorbe le vibrazioni.
- Guarnie laterali in alluminio che garantiscono resistenza e leggerezza.
- Possibilità di montaggio del martelletto opzionale # 885010000KK.



#	Standards	Peak material	Body material	g	cm
885000000KK	DPI category II	zincated steel	alu / wood	590	50

TOOL LEASH / Y TOOL LEASH

- Elastic lanyard for attaching work tools such as a hammer, screwdriver, camera, etc...
- Equipped with a mini connector for the tool and an adjustable loop to connect it to the harness. Available in single or double arm. Not for human support.
- Longe elastica per collegare all'imbrago attrezzi da lavoro tipo martello, chiavi, piccozza, ecc...
- Dotata di un mini connettore da collegare all'attrezzo e un'asola con fibbia regolabile per connetterla all'imbrago. Disponibile in versione a braccio singolo e a Y. Non adatta per la sospensione.



#	Standards	Color	Material	g	cm
TOOL LEASH					
885050000KK	-	■	-	40	85/130
Y TOOL LEASH					
885020000KK	-	■	-	105	-

DHINO CLASSIC

- Classic mountaineering ice axe. Light alu alloy body, zinc plated steel peak and spike.
- Handle with differentiated grain finish for improved grip.
- Tape leash to avoid loss.
- Available in two sizes (50 and 60 cm).
- Certified to CE EN 13089/1.
- Piccozza da alpinismo classica con corpo in alluminio e becca e puntale in acciaio zincato.
- Impugnatura con finitura a grana differenziata per migliorare il grip.
- Dragonne in fettuccia, per renderla imperdibile.
- Disponibile in due misure (50 e 60 cm).
- Certificata CE EN 13089/1.



#	Standards	Peak material	Body material	g	cm
8A2500PN0KK	• EN 13089/1	zincated steel	alu alloy	395	50
8A2600PN0KK	• EN 13089/1	zincated steel	alu alloy	435	60

DHINO ALPINE

- Technical mountaineering ice axe. Light alu alloy bent body, zinc plated steel peak and spike.
- Handle with differentiated grain finish for improved grip.
- Tape leash to avoid loss.
- Available in three sizes (50, 55 and 60 cm).
- Certified to CE EN 13089/1.
- Piccozza tecnica da alpinismo evoluto con corpo curvo in alluminio e becca e puntale in acciaio zincato.
- Impugnatura con finitura a grana differenziata per migliorare il grip.
- Dragonne in fettuccia, per renderla imperdibile.
- Disponibile in tre misure (50, 55 e 60 cm).
- Certificata CE EN 13089/1.



#	Standards	Peak material	Body material	g	cm
8A1500PN0KK	• EN 13089/1	zincated steel	alu alloy	395	50
8A1550PN0KK	• EN 13089/1	zincated steel	alu alloy	415	55
8A1600PN0KK	• EN 13089/1	zincated steel	alu alloy	438	60

LYS

- Light and compact 12-point steel crampons, designed for classic and technical mountaineering, from glacier progression to mixed routes.
- Available in automatic and semi-automatic versions.
- Structure in tempered steel.
- Innovative system for extremely accurate and stable micro-adjustment of the fit, without the use of tools.
- Innovative rigid/foldable connection system which allows the crampon to bend on itself, reducing the overall dimensions for transport. At the same time, it ensures maximum shoe stability and reliability during progression.
- Special adjustable closure buckle on the security sling.
- Lys is the steel crampon of performance and versatility, dedicated to the alpinist who wants to deal with a variety of terrain, without settling for compromise.
- Ramponi in acciaio a 12 punte leggeri e compatti, progettati per l'alpinismo classico e tecnico, dalla progressione su ghiacciaio alla via di misto.
- Disponibili in versione automatica e semi-automatica.
- Struttura in acciaio temprato.
- Innovativo sistema di micro-regolazione della taglia senza l'ausilio di attrezzi, estremamente preciso e stabile.
- Innovativo sistema di collegamento rigido/pieghevole: permette di piegare il ramponi su se stesso riducendone l'ingombro per il trasporto, garantendone al contempo la massima affidabilità e stabilità di calzata durante la progressione.
- Speciale fibbia di chiusura/regolazione della fettuccia di sicurezza.
- Lys è il ramponi in acciaio, performante e versatile, dedicato all'alpinista che vuole affrontare svariati terreni di progressione senza scendere a compromessi.

Stepless adjustment!
Regolazione micrometrica!!



#8A312S000KK
Lys Semi-Automatic

#	Standards	Material	g	N° points	Binding
LYS AUTOMATIC					
8A312A000KK	EN 893	carbon steel	795	12	automatic
LYS SEMI-AUTOMATIC					
8A312S000KK	EN 893	carbon steel	810	12	semi-automatic



#8A312A000KK
Lys Automatic



Foldable!
Pieghevole!



RUTOR

- Light and compact 10-point aluminum crampons, designed for ski mountaineering and progression on snow.
- Available in automatic and semi-automatic versions.
- Structure in light aluminum alloy.
- Innovative system for extremely accurate and stable micro-adjustment of the fit, without the use of tools.
- Innovative rigid/foldable connection system which allows the crampon to bend on itself, reducing the overall dimensions for transport. At the same time, it ensures maximum shoe stability and reliability during progression.
- Special adjustable closure buckle on the security sling.
- Rutor is the aluminum crampon designed for the demanding ski mountaineer who wants a light performance tool which is safe and reliable in every situation.
- Ramponi in alluminio a 10 punte leggeri e compatti, progettati per lo scialpinismo e la progressione su neve.
- Disponibili in versione automatica e semi-automatica.
- Struttura in lega leggera di alluminio.
- Innovativo sistema di micro-regolazione della taglia senza l'ausilio di attrezzi, estremamente preciso e stabile.
- Innovativo sistema di collegamento rigido/pieghevole: permette di piegare il ramponi su se stesso riducendone l'ingombro per il trasporto, garantendone al contempo la massima affidabilità e stabilità di calzata durante la progressione.
- Speciale fibbia di chiusura/regolazione della fettuccia di sicurezza.
- Rutor è il ramponi in alluminio pensato per lo scialpinista esigente che vuole un attrezzo leggero e performante ma al tempo stesso sicuro ed affidabile in ogni situazione.

Stepless adjustment!
Regolazione micrometrica!!



#8A410A000KK
Rutor Automatic

#	Standards	Material	g	N° points	Binding
RUTOR AUTOMATIC					
8A410A000KK	EN 893	alu alloy	480	10	automatic
RUTOR SEMI-AUTOMATIC					
8A410S000KK	EN 893	alu alloy	490	10	semi-automatic



#8A410S000KK
Rutor Semi-Automatic



Foldable!
Pieghevole!



GRODEL

- Small crampons with standard fastening, for use on trekking and walking shoes.
- Attention: use this small crampon for excursions on flat, iced ground only.
- Ramponcino con allacciatura classica a lacci. Adatto per l'utilizzo su scarpe da trekking e da passeggiata.
- Attenzione: utilizzate questo ramponcino solo per escursioni su terreni ghiacciati piani.



#	Standards	Material	g	N° points	Binding
GRODEL					
82304000KK	• -	carbon steel	250	4	laces

TRIX CARBON

- Super light hiking pole, only 200g per piece!
- Made of three telescopic segments with adjustment notches, maximum length 141 cm.
- The first segment is made of carbon, the others are made of aluminum to ensure maximum lightness and bending / compression resistance.
- Ergonomic ERGO foam handle and adjustable strap for a perfect grip in any situation.
- Bastone da trekking super leggero, solo 200g al pezzo!
- Formato da tre segmenti telescopici con tacche di regolazione. Lunghezza massima 141cm.
- Il primo segmento di tubo è realizzato in carbonio, gli altri due sono in alluminio per garantire massima leggerezza e resistenza a flessione e compressione.
- Impugnatura ergonomica in schiuma ERGO e fettuccia regolabile per una presa perfetta in qualunque situazione.



#	Material	g	Min. length cm	Max length cm
99620000KK	alu alloy carbon fiber	200	66	141

ROX

- Alu hiking pole fitted with three-section foldable shaft for quick storage.
- Ultra-compact dimensions, only 37 cm when closed.
- With adjustment notches, adjustable length from 107 to 130 cm.
- The ergonomic handle made of ERGO foam and adjustable anti-bacterial tape, guarantee a perfect grip in any situation.
- Supplied with two baskets of different dimensions and tip cap for transportation.
- Weight: 300 g
- Length - open: 107-130cm
- Length - closed: 37cm
- Tubes diameter: Ø 18/14mm
- Material: Alu alloy
- Handle: Ergo foam
- Basket: small 38mm - large 89mm
- Tip: Carbide
- Bastone da trekking pieghevole ultra-compacto, solo 37 cm da chiuso.
- Composto da tre segmenti in alluminio velocemente assemblabili. Dotato di tacche di regolazione, lunghezza regolabile da 107 a 130cm.
- L'impugnatura ergonomica in schiuma ERGO e la fettuccia antibatterica regolabile, garantiscono una presa perfetta in qualunque situazione.
- Fornito con due rotelle di dimensioni differenti e copripunta per il trasporto.
- Peso: 300 g
- Lunghezza aperto: 107-130cm
- Lunghezza chiuso: 37cm
- Diametro tubi: Ø 18/14mm
- Materiale: Alluminio
- Impugnatura: Ergo schiuma espansa
- Rotella: small 38mm - large 89mm
- Punta: Carbide



#	Material	g	Min. length cm	Max length cm
99640000KK	alu alloy	300 (600 pair)	107	130



Omni Bag



Genius II



Rope Bag 100



Rope Bag 200



Free Rope Bag



Lirung



Linhã

OMNI BAG

- Bag for carrying ropes and equipment, with concealable, comfortable padded shoulder straps and removable wide lumbar support.
- Haul loops of different lengths for barycentric suspension.
- Inner wide opening for convenient access to the bag's contents.
- Inner roll closure with aluminium buckle and external drawstring closure.
- Side opening equipped with an ultra-resistant size 10 nylon zip with a protective anti-rubbing flap and an automatic button that prevents accidental opening.
- Rear identification label.
- Rear loop for suspension.
- Transparent side pocket to hold an identification tag.
- Internal removable pocket with zipper and textile loops for storing the smallest of tools.
- Made of extremely durable PVC.
- Reinforced bottom with wear-resistant edge.
- Double seams at the points of greatest stress.
- 50L capacity which is expandable to 60L.
- Sacca per trasporto di corde e attrezzatura dotato di comodi spallacci imbottiti occultabili e ampio fascione lombare rimovibile.
- Anelli per la sospensione baricentrica di lunghezza differenziata.
- Ampia apertura superiore che garantisce un accesso confortevole al contenuto del sacco.
- Chiusura interna a rullo con fibbia in alluminio e chiusura esterna a coulisse.
- Apertura laterale dotata di zip in nylon taglia 10 ultra-resistente con patella protettiva anti-sfregamento e bottone automatico che evita l'apertura accidentale.
- Etichetta identificativa posteriore.
- Anello posteriore per la sospensione.
- Tasca interna amovibile con cerniera e anelli tessili per riporre gli oggetti più piccoli.
- Realizzato in PVC estremamente resistente.
- Fondo rinforzato e dotato di bordo anti-usura.
- Cuciture doppie nei punti di maggiore sollecitazione.
- Capacità 50 l estendibile a 60 l.

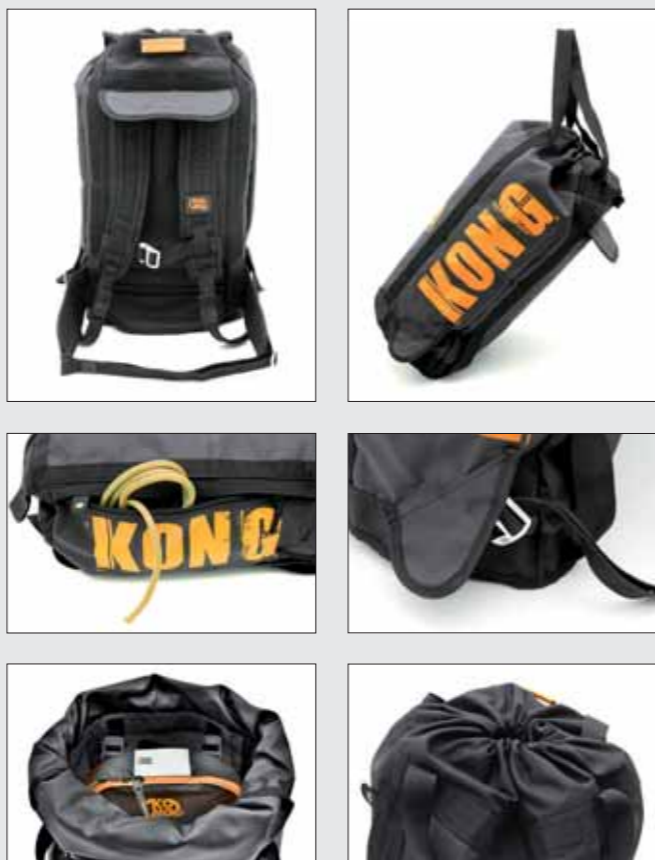
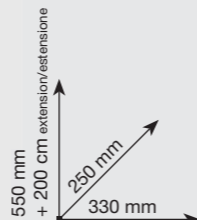

#	Material	Color	Capacity l	g
OMNI BAG				
982524N00KK	PVC	■	60	1300
MINI BAG				
982531O00KK	nylon	■	8	255

MINI BAG (optional)

- Optional backpack that can be fixed inside the bag OMNIBAG through dedicated attachments.
- Can be used as rope bag or for personal accessories to be stored separately.
- Opening with 270° double slider zip.
- Fixing loops with different colors for the ends of the rope.
- Internal pocket with zip for documents.
- 3 internal textile loops for fixing materials.
- Capacity 8 l.
- Zaino opzionale fissabile all'interno della sacca OMNIBAG tramite gli attacchi dedicati.
- Utilizzabile come porta-corda o per accessori personali da riporre separatamente.
- Apertura a zip doppio cursore a 270°.
- Asole di fissaggio a colori differenziati per i capi della corda.
- Tasca interna porta-documenti con cerniera.
- 3 asole tessili interne per fissaggio materiali.
- Capacità 8 l.

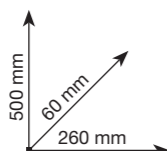

GENIUS II

NEW

- Resistant carry and hauling bag, fitted with large reinforced loops for suspension.
- The comfortable and foldaway shoulder straps avoid entanglement during lowering and recovery operations.
- The oblique cut of the upper part keeps the bag open when using the special hanging eyelet.
- Fitted with practical inner pockets.
- Capacity: 30 liters.
- Resistente sacco da trasporto e recupero materiale, dotato di ampi anelli rinforzati per la sospensione.
- I comodi spallacci a scomparsa evitano qualunque impiglio in fase di calata e recupero.
- Il taglio obliquo della parte superiore permette di mantenere il sacco aperto appendendolo tramite l'apposito occhio.
- Dotato di pratiche tasche porta-oggetti.
- Capacità: 30 litri.



#	Material	Color	Capacity l	g
982534N00KK	PVC	■	30	850

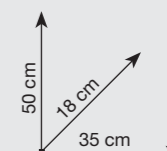

ROPE BAG

- Backpack for carrying ropes and equipment.
- Fitted with padded shoulder straps for comfort and a loop for hanging.
- Angled closure flap ensures easy access to the contents, with a loop for suspension which ensures convenient access to the bag's contents.
- Drawstring closure and rapid clip made of ultra-durable nylon.
- Transparent side pocket for a name tag.
- Interior zippered pocket for storing small tools.
- Made of extremely durable PVC; reinforced on the bottom with slotted holes for breathability and a handle for emptying.
- Available in two versions:
capacity 28 l, it can hold a 100 m rope
capacity 43 l, it can hold a 200 m rope.
- Zaino per trasporto di corde e attrezzatura dotato di comodi spallacci imbottiti e gancio per la sospensione.
- Patella di chiusura a taglio obliquo e asola per la sospensione che garantiscono un accesso confortevole al contenuto del sacco.
- Chiusura con coulisse e clip rapida in nylon ultra-resistente.
- Tasca laterale trasparente per inserire la targhetta identificativa.
- Tasca interna con cerniera per riporre gli attrezzi più piccoli.
- Realizzato in PVC estremamente resistente; fondo rinforzato con fori asolati per la traspirazione e maniglia per lo svuotamento.
- Disponibile in due versioni:
capacità 28 l, può contenere una corda da 100 m
capacità 43 l, può contenere una corda da 200 m.

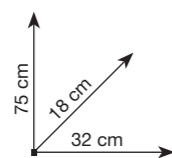
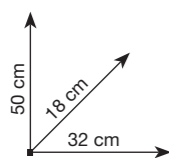

#	Material	Color	Capacity l	g
ROPE BAG 100				
982501000KK	PVC	■	28	700
ROPE BAG 200				
982502000NK	PVC	■	43	800

FREE ROPE BAG

- Rope bag, comfortable and lightweight, designed for use in climbing.
- Inner ground tarp to protect the rope, with 4 loops for tying the rope or moving.
- Wide opening for easy repositioning of the rope.
- Rapid clip and drawstring closure, wide external pocket with zip closure.
- Comfortable padded shoulder straps.
- Holds a 70 meter rope (not included).
- Capacity: 20 liters
- Zaino porta corda, comodo e leggero. Ideale per l'utilizzo in falasia.
- All'interno dello zaino e' contenuto il telo da mettere a terra per proteggere la corda, dotato di 4 asole per il fissaggio.
- Ampia apertura per la massima facilità di riposizionamento della corda.
- Chiusura rapida a clip e coulisse, ampia tasca esterna con chiusura a zip.
- Comodi spallacci imbottiti.
- Può contenere una corda da 70 metri (non inclusa)
- Capacità: 20 litri

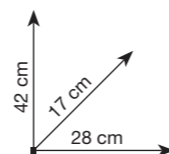

#	Material	Color	Capacity l	g
981050000KK	nylon	■ ■	20	460

LINNHÀ

- Middle volume backpack designed for use for easy descents without large vertical, with access and very short exit; intended for professional use of guides
- Main features:
 - middle volume (40 liters); in operating conditions can contain one 60m rope 10 mm diameter and a bag or a waterproof bin; during the transportation, it can contain 1 full wetsuit and a bag or tin bins, as well as other objects; the 60 m rope can be transported outside of the backpack, closing it with the lateral compression belts.
 - fast emptying thanks to the mesh structure (rapid emptying means less fatigue)
 - light and comfortable during transportation, thanks to the backrest mesh structure that allows a good transpiration
 - detachable top flap that can be used separately as a bolting bag (hammer for anchors, spit driller, camera etc.)
 - practical lateral compression belts that allow you to attach ropes and other large objects to the backpack in the approach phase, dedicating the internal volume to the wetsuit and other delicate objects. The belts are also necessary for the attachment of the rope bag Lirung to the backpack, for an easier transport and use of the rope.
 - adjustable shoulder straps with quick release for disengaging, with daisy chain integrated
 - adjustable waist belt
 - practical and solid ergonomic carrying handles
 - internal loops for gear holders in 2 vivid colours
 - internal rings for attachment of rope extremities in 2 vivid colours
- Zaino di medio volume progettato per un utilizzo per facili discese prive di grandi verticali, con accesso ed uscita molto brevi; destinato all'uso professionale della guida.
- Caratteristiche principali:
 - volume medio (40 litri); in assetto operativo può contenere 1 corda di 60 m 10 mm ed una sacca o bidoncino stagno; in fase di trasporto può contenere 1 muta umida completa ed una sacca o bidoncino stagno, oltre ad altri oggetti; la corda da 60 m può essere trasportata esternamente allo zaino, bloccandola con le cinghie laterali di compressione
 - svuotamento rapido grazie alla struttura a rete (svuotamento rapido significa minore fatica)
 - leggero e confortevole nel trasporto, grazie alla struttura a rete dello schienale che permette una buona traspirazione
 - patella staccabile ed utilizzabile separatamente come sacca d'armo (martello ancoraggi, perforatore spit, macchina fotografica etc).
 - pratiche cinghie laterali di compressione che consentono di attaccare allo zaino corde ed altri oggetti voluminosi nella fase di avvicinamento, dedicando il volume interno alla muta ed altri oggetti delicati. Le cinghie servono anche per l'aggancio allo zaino della sacca porta corda Lirung, per un trasporto ed un utilizzo facilitato della corda
 - spallacci regolabili, a sgancio rapido, con daisy chain integrate
 - cintura addominale regolabile
 - pratiche e robuste maniglie di trasporto ergonomiche
 - asole interne porta materiali di 2 colori vivaci
 - anelli interni per l'aggancio dei capicorda in 2 colori vivaci

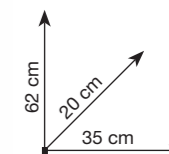

#	Material	Color	Capacity l	g
982522000KK	PVC	■ ■	40	1350

LIRUNG

- Rope bag developed for rope transport in canyon.
- Intended for professional use, explorers, guides, instructors and first aid specialists in canyon
- Main features:
 - it contains 60m rope of 10mm (also already used) or 80m rope of 9mm (also already used)
 - fast emptying thanks to the mesh structure (rapid emptying means less fatigue)
 - lightweight
 - internal separator in mesh in order to have, in a practical way, both rope branches: the terminal part of the rope slips out easily and it can be also put again, separating it from the other rope branch; very functional detail when you reinsert the rope.
 - comfortable in the transportation, thanks to the adjustable shoulder straps, which, if necessary can be removed from buckles and stowed in the internal gear holder bag
 - internal gear holder bag, useful for housing descender, rings, slings/lanyards etc.)
 - wide carrying handle
 - extension cord for hooking the backpack during a break
 - internal rings for attachment of rope extremities in 2 vivid colours
- Sacca porta corda progettata per il trasporto delle corde in canyon.
- È destinata ad un uso professionale, esploratori, guide, istruttori, tecnici del soccorso in canyon.
- Caratteristiche principali:
 - contiene 60 m di corda da 10 mm (anche usata) oppure 80 m di corda da 9 mm (anche usata)
 - svuotamento rapido grazie alla struttura a rete (svuotamento rapido significa minore fatica)
 - leggero
 - separatore interno in rete per disporre in modo pratico entrambi i rami di corda: il ramo di fine corda si sfilava comodamente e si può anche riporre di nuovo separandolo dall'altro ramo di corda; dettaglio molto funzionale nel momento in cui si reinserisce la corda del mancorrente
 - confortevole nel trasporto grazie agli spallacci regolabili, che all'occorrenza possono essere sfilati dalle fibbie e riposti nella tasca interna portaoggetti
 - tasca interna portaoggetti, per alloggiare discensore, anelli, cordini etc)
 - ampia maniglia di trasporto
 - prolunga per aggancio dello zaino in sosta
 - anelli interni per l'aggancio dei capicorda in 2 colori vivaci



#	Material	Color	Capacity l	g
982521000KK	PVC		25	750

CHALK BAG

- Chalk bag for climbing and mountaineering.
- Wide opening for easy chalking.
- Drawstring closure and double loops for attaching to the harness.
- Elastic webbing to hold the brush.
- New design matching the Hornet crash pad.
- Sacca porta-magnesite, per arrampicata e alpinismo.
- Ampia apertura per un passaggio agevole della mano.
- Chiusura con coulisse, doppia asola per il fissaggio all'imbrago.
- Fettuccia elastica per posizionare lo spazzolino. Nuova grafica abbinata al crash pad Hornet.



#	Material	Capacity l	g
848000000KK	polyamide	-	60

GADGETS



MINI HARNESS



MINI CHOCK



OTTINO



KONG PLATE PAPERWEIGHT



MINI PEAR



#	Material	Colour
MINI HARNESS		
705050400KK	alu alloy	
705060400KK	alu alloy	
MINI PEAR		
755050400KK	alu alloy	
755060400KK	alu alloy	
MINI CAM		
838KEY400KK	alu alloy	
MINI CHOCK		
835KEY400KK	alu alloy	
OTTINO		
345000000YK	bronze	
KONG PLATE		
346000000YK	bronze	

USB PENDRIVE 8 GB



MINI CAM



BANNER 75X200 CM (VARIOUS SUBJECTS)



#	Notes
6E0000017KK	Climbing
6E0000018KK	Adventure Parks
6E0000019KK	Caving
6E0000020KK	Canyoning
6E0000021KK	Intervention
6E0000022KK	Work At Height
6E0000023KK	Rescue
6E0000024KK	Arboriculture
6E0000025KK	Yachting
6E0000026KK	Leather Goods

STICKERS 6X4 CM



CAPS POLYPROPYLENE



NEK WARMER MULTIFUNCTION

NEW

- Multifunction tube neck warmer, suitable for all types of outdoor activities, mountaineering, skiing, mountain biking...
- Hemless and seamless for better comfort.
- Elastic fabric, unisex, one size fits all.
- Available in various colors.
- Scaldacollo a tubo multifunzione, adatto ad ogni tipo di attività outdoor, alpinismo, sci, mountainbike...
- Senza orlo e senza cuciture per un migliore comfort.
- Tessuto elastico, unisex, taglia unica.
- Disponibile in vari colori.



#	Material	Size	Colour
CAPS			
997047B02KK	polypropylene	small: S/M	
997047B04KK	polypropylene	large: L/XL	
997047G02KK	polypropylene	small: S/M	
997047G04KK	polypropylene	large: L/XL	
997047O02KK	polypropylene	small: S/M	
997047O04KK	polypropylene	large: L/XL	
NEK WARMER			
6E0000041KK	polyester	UNI	
6E0000042KK	polyester	UNI	
6E0000043KK	polyester	UNI	

HOODIE MEN



	Cyan	Orange
S	6I001B002KK	6I001O002KK
M	6I001B003KK	6I001O003KK
L	6I001B004KK	6I001O004KK
XL	6I001B005KK	6I001O005KK

HOODIE WOMEN

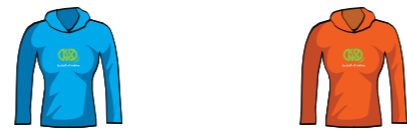

	Cyan	Orange
S	6I002B002KK	6I002O002KK
M	6I002B003KK	6I002O003KK
L	6I002B004KK	6I002O004KK
XL	6I002B005KK	6I002O005KK

T-SHIRT TECHNICAL NATURE MEN



	Cyan	Green	Yellow	Orange
S	6I003B002KK	6I003G002KK	6I003Y002KK	6I003O002KK
M	6I003B003KK	6I003G003KK	6I003Y003KK	6I003O003KK
L	6I003B004KK	6I003G004KK	6I003Y004KK	6I003O004KK
XL	6I003B005KK	6I003G005KK	6I003Y005KK	6I003O005KK

T-SHIRT TECHNICAL NATURE WOMEN



	Cyan	Green	Fucsia	Purple
S	6I004B002KK	6I004G002KK	6I004F002KK	6I004V002KK
M	6I004B003KK	6I004G003KK	6I004F003KK	6I004V003KK
L	6I004B004KK	6I004G004KK	6I004F004KK	6I004V004KK
XL	6I004B005KK	6I004G005KK	6I004F005KK	6I004V005KK

T-SHIRT SERIAL CLIMBER MEN



	Cyan	Green	Yellow	Orange
S	6I005B002KK	6I005G002KK	6I005Y002KK	6I005O002KK
M	6I005B003KK	6I005G003KK	6I005Y003KK	6I005O003KK
L	6I005B004KK	6I005G004KK	6I005Y004KK	6I005O004KK
XL	6I005B005KK	6I005G005KK	6I005Y005KK	6I005O005KK



NOTE

The contents of this catalogue may not be used or copied, not even in part, without quoting the source and without the written permission from KONG S.P.A.

All rights reserved. As specifications, design, production and techniques are in continuous evolution, this brochure should not be regarded as an infallible guide. All data, colors of items and technical specifications given may be subject to change and improvement without warning or notice. Our website www.kong.it is constantly updated and/or corrected.

Il contenuto di questo catalogo non può essere usato o riportato neppure parzialmente senza citare la fonte e senza il permesso scritto della KONG S.P.A. Tutti i diritti sono riservati. Poiché le specifiche, la progettazione, la produzione e le tecniche sono in continua evoluzione, tale catalogo non deve essere considerato una guida infallibile. Tutti i dati, i colori degli articoli e le caratteristiche tecniche riportati possono subire modifiche e miglioramenti senza alcun preavviso. Il ns. sito www.kong.it viene costantemente aggiornato e/o corretto.

Where we are, reach us
Dove siamo, raggiungi

Follow us



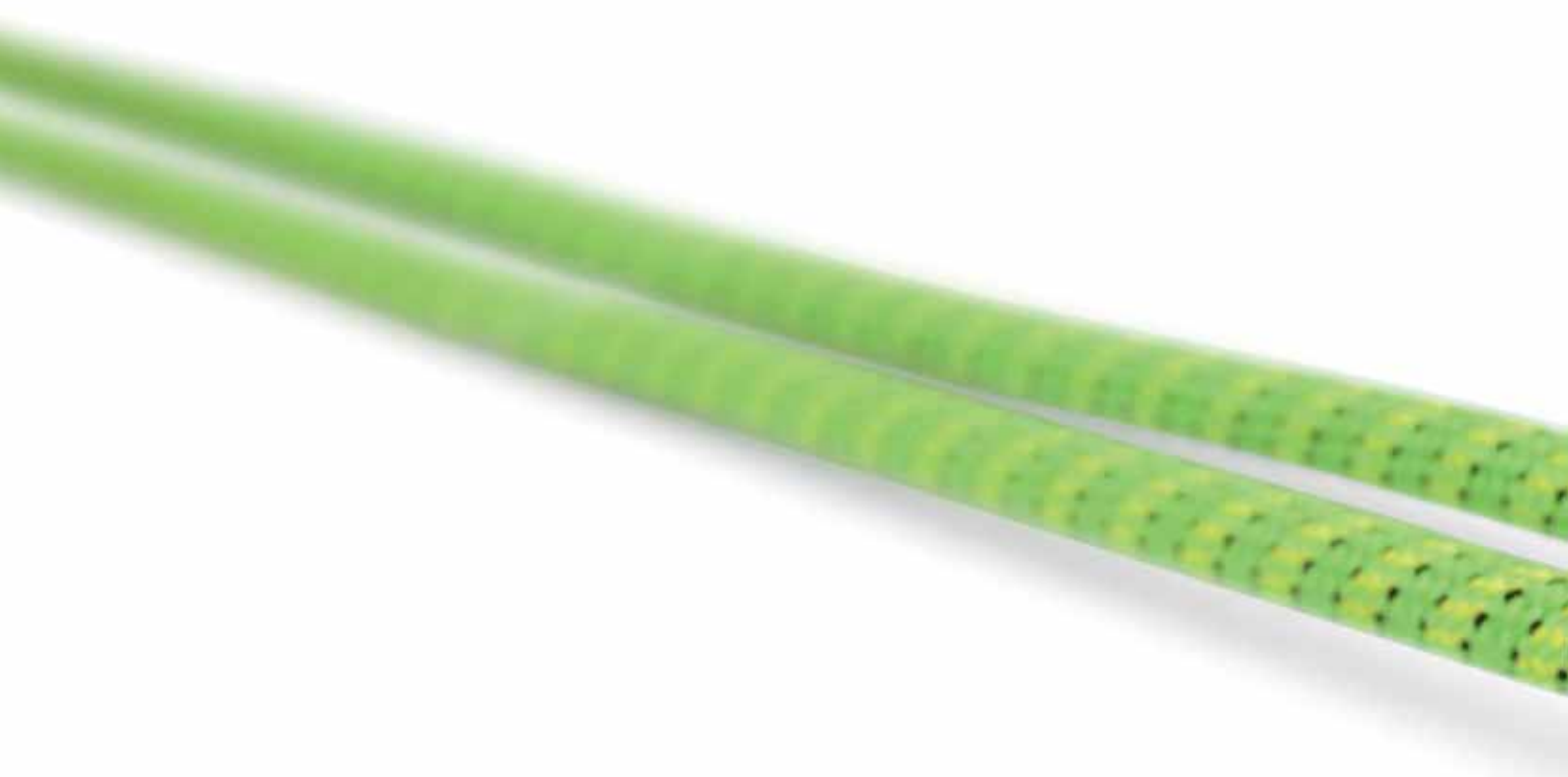

KONG s.p.a.

Via XXV Aprile, 4 - (zona industriale)

I - 23804 MONTE MARENZO (LC) - ITALY

Tel +39 0341630506 - Fax +39 0341641550 - info@kong.it

www.kong.it

"Campione gratuito di modico valore (art. 2 c. 3 DPR 633/72)"

KONG - OUTDOOR 2022
EN/IT - Rev. 0



8 023577 052694