

QTP-T/E 1X18,2X18

QUICKTRONIC PROFESSIONAL M | ECG for CFL



Product family features

- Supply voltage: 220...240 V
- Line voltage: 198...264 V
- Line frequency: 0 Hz | 50 Hz | 60 Hz
- Lamp start with optimum filament preheating
- Energy Efficiency Index EEI: A2
- Automatic shutdown of defective lamps and at end of life (EoL T.2)
- Lamp operation: to EN 60929
- Safety: to EN 61347-2-3

Product family benefits

- Long lamp life
- No adverse effect from frequent on/off switching
- Automatic restart after lamp replacement
- Perfect lamp start for applications with motion sensors
- Separate installations thanks to optional cable clamp for K2 and K3 casings
- VDE/VDE EMC certified system

Areas of application

- Emergency lighting systems acc. to EN 50172 / DIN VDE 0108-100
- Public buildings
- Sports halls and factories
- Suitable for luminaires of protection class I

Product datasheet

Technical data

Electrical data

Input voltage AC	198...264 V
Nominal voltage	220...240 V
Mains frequency	50...60 Hz
Input voltage DC	176...264 V
Maximum output power	2 x 18 W
Efficiency in full-load	89 % ¹⁾
Operating frequency	40...50 kHz
Max. ECG no. on circuit breaker 10 A (B)	17 ²⁾
Max. ECG no. on circuit breaker 16 A (B)	28 ²⁾

¹⁾ at 230 V, 50 Hz

²⁾ Type B

Light technical data

Starting time	1.0 s
---------------	-------

Dimensions & weight

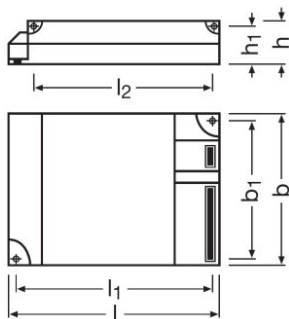

Length	103.0 mm
Width	67.0 mm
Height	31.0 mm
Mounting hole spacing, length	94.0 mm
Product weight	149.00 g
Cable cross-section, output side	0.5...1.5 mm ²
Cable cross-section, input side	0.5...1.5 mm ²

Temperatures & operating conditions

Ambient temperature range	-20...+50 °C
---------------------------	--------------

Product datasheet

Permitted rel. humidity during operation	5...85 % ¹⁾
--	------------------------

¹⁾ Maximum 56 days/year at 85 %

Lifespan

ECG lifetime	50000 h ¹⁾
--------------	-----------------------

¹⁾ At $T_{case} = 75^{\circ}C$ at T_c point / 10% failure rate

Expected Lifetime

Product name	Lamp group				
QTP-T/E 1X18,2X18	DULUX T/E 18 W	ECG ambient temperature [ta]	40	50	60
		Temperature at tc-point [°C]	55	65	70
		Lifetime [h]	100000	100000	60000

Additional product data

Suitable for lamp power (1 lamp)	18 W
Suitable for lamp power (2 lamps)	18 W

Capabilities

Suitable for fixtures with prot. class	I / II
End of lamp life safety shutdown	EOL T.2
Max. cable length to lamp/LED module	2.0 m / 1.0 m
Dimmable	No
Intended for no-load operation	No

Certificates & standards

Approval marks – approval	VDE / VDE-EMC / ENEC 10 / GOST / RCM
EEL – Energy Label	A2 BAT
Standards	Acc. to EN 61347-2-3/Acc. to EN 60929/Acc. to EN 55015:2006 + A1:2007/Acc. to EN 61000-3-2/Acc. to EN 61547
Protection class	III
Type of protection	IP20

Logistical data

Commodity code	85041080900
----------------	-------------

Environmental information

Product datasheet

Information according Art. 33 of EU Regulation (EC) 1907/2006 (REACH)	
Date of Declaration	26-05-2023
Primary Article Identifier	4008321537065
Candidate List Substance 1	Lead
CAS No. of substance 1	7439-92-1
Safe Use Instruction	The identification of the Candidate List substance is sufficient to allow safe use of the article.
Declaration No. in SCIP database	8cd7a45f-abcc-438a-93aa-ff6c6a399b3a

Wiring Diagram

QUICKTRONIC® QTP-D/E + QTP-T/E

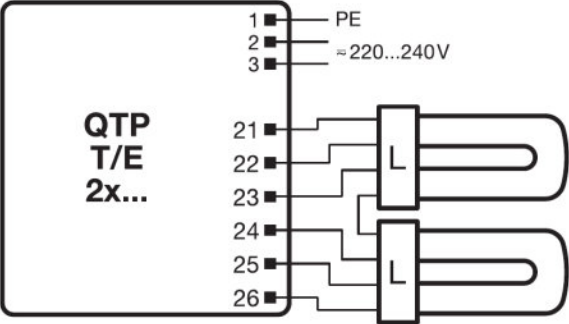
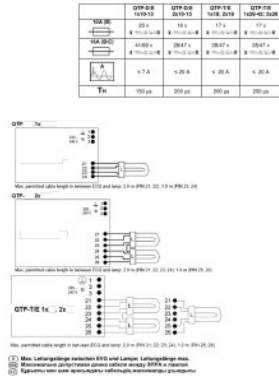

596657_EAC QTP-DE + QTP-TE

723139_Wiring Diagram QTP-TE 2x

Product datasheet

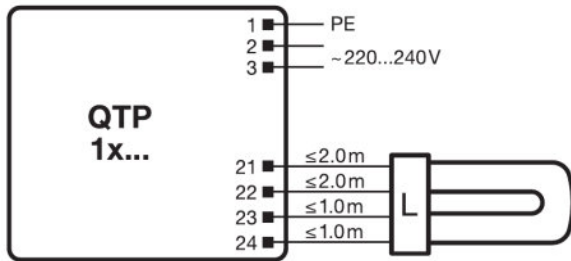







723146_Wiring diagram QTP 1x

Additional product information

- In order to achieve good radio interference suppression:1. Keep the cable between ECG and lamp as short as possible.2. The single lamp wires must be routed as close as possible to each other, whereas the lines of the different lamp ends must be routed separately.

Download Data

File
 User instruction QUICKTRONIC QTP D E QTP T E
 Product Datasheet 502688_ECG lifetime - QUICKTRONIC non DIM
 Certificates 334954_ENEC-Marks approval
 Certificates 334956 EMC-Marks approval – QTP-M
 Certificates 335169_Manufacturer's declaration – LampECG combinations: Frequent switching
 Certificates 504181_VDE-EMC-Certificate QTP DL_TE
 Declarations of conformity QUICKTRONIC CE 3364256 190821

Product datasheet

Ecodesign regulation information:

Separate control gear and light sources must be disposed of at certified disposal companies in accordance with Directive 2012/19/EU (WEEE) in the EU and with Waste Electrical and Electronic Equipment (WEEE) Regulations 2013 in the UK. For this purpose, collection points for recycling centres and take-back systems (CRSO) are available from retailers or private disposal companies, which accept separate control gear and light sources free of charge. In this way, raw materials are conserved and materials are recycled.

Logistical Data

Product code	Product description	Packaging unit (Pieces/Unit)	Dimensions (length x width x height)	Volume	Gross weight
4008321537065	QTP-T/E 1X18,2X18	Shipping carton box 20	360 mm x 230 mm x 90 mm	7.45 dm ³	3266.00 g

The mentioned product code describes the smallest quantity unit which can be ordered. One shipping unit can contain one or more single products. When placing an order, for the quantity please enter single or multiples of a shipping unit.

Disclaimer

Subject to change without notice. Errors and omission excepted. Always make sure to use the most recent release.

QTP-T/E 1X18,2X18

QUICKTRONIC PROFESSIONAL M | ECG for CFL

Product name	Lamp group	Nominal current	Nominal wattage + Power loss	Power factor λ [PIM]	Luminous flux at 25 °C	Number of lighting outlets
QTP-T/E 1X18,2X18	DULUX D/E 18 W	0.16 A	36.00 W	0.98	1200 lm	2
	DULUX T/E 18 W	0.16 A	36.00 W	0.98	2*2200 lm	2
	DULUX D/E 18 W	0.09 A	19.00 W	0.90 c	1*1200 lm	1
	DULUX T/E 18 W	0.09 A	19.00 W	0.90 c	1*1200 lm	1