

Accessories

Standard : ● Optional : ★

Description	Modle	5BC-X26	5BC-X29	5BC-X34	5BC-X38	5BC-X42
1.Air blast through spindle_M53		●	●	●	●	●
2.Air conditioning for electrical cabinet habor HA-750AF		●	●	●	●	●
3.ARM Type ATC 32P		●	●	●	●	●
4Automatic Power off		●	●	●	●	●
5.Built-in Spindle 15000RPM/HSK-A63		●	●	●	●	●
6.Calibration spheres (KKH 250)		●	●	●	●	●
7.Coolant system_Coolant Pump Motor,Stand		●	●	●	●	●
8.Centralized Automatic Lubrication System		●	●	●	●	●
9.X, Y, Z-axis linear scale system_HEIDENHAIN		●	●	●	●	●
10.Dynamic Collision Monitoring(#40)		●	●	●	●	●
11.Full-enclosed splash guard_multi-piece door		●	●	●	●	●
12.Fluorescent lamp x 1		●	●	●	●	●
13.Foundation bolt		●	●	●	●	●
14.Hydraulic Hose Coolant gun		●	●	●	●	●
15.Individual machine manual x 1		●	●	●	●	●
16.kinematicOpt(#48 CYCLE 451)		●	●	●	●	●
17.Link Type Chip Conveyor and Portable chip bucket		●	●	●	●	●
18.Maintenance safety guard(Including maintenance ladder)		●	●	●	●	●
19.WORKPIECE MEASURE PROBE(HEIDENHAIN TS-460)		●	●	●	●	●
20.Pedal Ladder_L1500*W800*H490mm [L59.06**W31.50**H19.29"]		★	★	★	★	★
21.RS232 Interface		●	●	●	●	●
22.Remote manual pulse generator/HR510		●	●	●	●	●
23.Spindle Water Cooler		●	●	●	●	●
24.Spray around spindle		●	●	●	●	●
25.Spindle Air Curtain		●	●	●	●	●
26.Screw Type Chip Conveyor		●	●	●	●	●
27.Tool package		●	●	●	●	●
28.Y-axis ball screw support device		★	●	●	●	●
29.Z Axis Nitrogen Counter Balance		●	●	●	●	●
30.Air gun		★	★	★	★	★
31.ARM Type ATC 40P		★	★	★	★	★
32.Built-in Spindle12000RPM/HSK-A100(CYTEC)		★	★	★	★	★
33.Built-in Spindle 24000RPM/HSK-A63		★	★	★	★	★
34.Coolant Through Spindle_20BAR [290.07PSI] With Water Cart		★	★	★	★	★
35.Coolant Through Spindle_25BAR [362.58PSI] With Water Cart		★	★	★	★	★
36.CTS full splash guard with top cover		★	★	★	★	★
37.Hoist Seat		★	★	★	★	★
38.TOUCH PROBE		★	★	★	★	★
39.X-axis ball screw support device		★	★	★	★	★
40. Software Option 1_Cylinder surface interpolation,Tilting plane,Circle in 3 axes (#8)		●	●	●	●	●
41.Software Option 2 Spline interpolation /TCPM (#9)		●	●	●	●	●
42.Kinematic coordinate conversion		●	●	●	●	●
43.TNCRemot Software		★	★	★	★	★



Intelligent Machining Center

5BC Series Smartcenter

- 5-Year warranty on guideways
- 5-axis head made by Hartford
- 4 linear guideways on Z-axis
- One-piece wider column design
- Slant beam design on cross beam



She Hong INDUSTRIAL CO. LTD.
 No.3 Jingke N. Road, Taichung City, 408 Taiwan
 www.hartford.com.tw Tel: 886-4-23501980 Fax: 886-4-23581793
 CAT.No.: 20190605-E09
 All Graphic and text on the catalog have been registered. Those who reprint will be held liable



Imagine what future machines ought to be outlined.

What is Automation?

Hartford
redefine the future

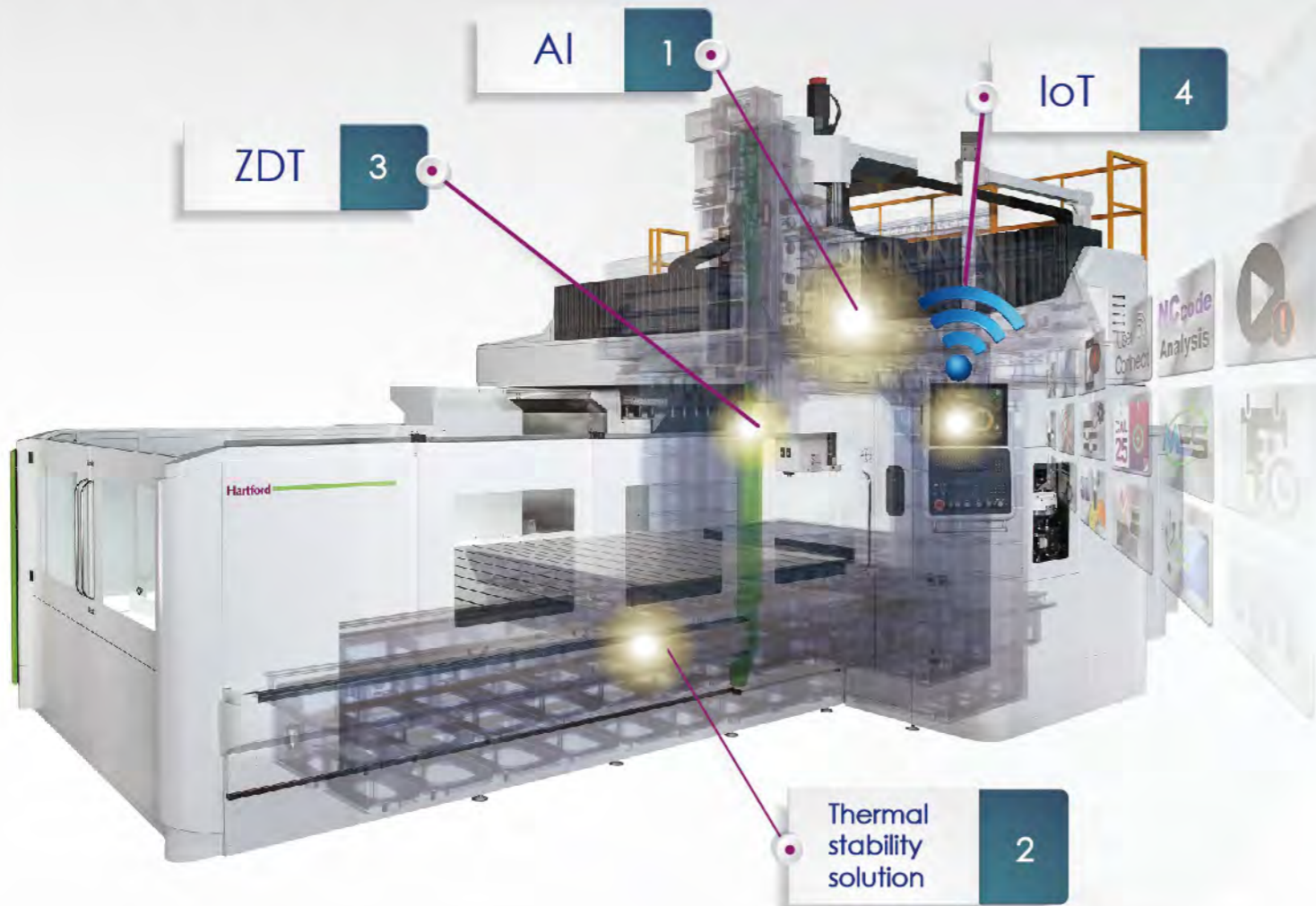

IoT 1

- + Remote Warm-up & Turn-on
- + Hartrol Plus Sync & Update
- + User Connect

Thermal stability solution 2

- + Spindle Thermal Compensation
- + Casting Thermal Compensation
- + Thermal Symmetry / Thermal Balancing

ZDT 3

- + Diagnosis Report on Spindle Operation
- + Alarm Report System

AI 4

- + Facial Recognition System
- + AI Efficient Lubrication Management
- + Smart Efficient Chip Collection

The meaning of automation?

Reducing manpower, increasing productivity, maintaining product quality & consistent precise movements without fatigue these all factors can be called "automation". There is a vast scope for automation from fully automatic engine cylinder manufacturing lines to simple robotic loading and unloading operations, the process of automatic workpiece measurement during machining can also be part of automation, so entering the field of automation is not so far away.

When it comes to machining processes, following features we can recommend to help our customers to enter the field of automation



With more intelligent function equals to closer automation.

How to quickly implement automation?

Hartford Robot Production Cell

Hartford has the biggest automation solution team in Taiwan. We design and plan the project by ourself. To be professional, provide rapidly response and efficient are our points. In this modern age, labor shortage is always a big problem for many companies. Hartford provides you a set of stable and efficient automatic solution project to solve your problems.

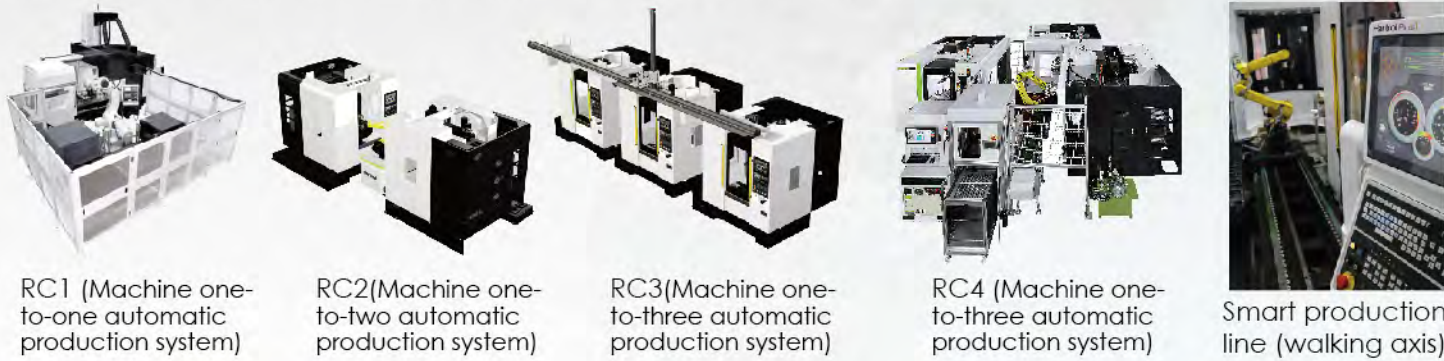

RC1 (Machine one-to-one automatic production system)

RC2(Machine one-to-two automatic production system)

RC3(Machine one-to-three automatic production system)

RC4 (Machine one-to-three automatic production system)

Smart production line (walking axis)

Easy to get started

Hartford Robocell provides you a professional robot training and rich automation experience, to let you quickly learn and easily operate your automation systems

Quality control monitoring

Automation systems have to pass all the strict Quality Control tests at every stage like design, assembly, testing, final inspection and shipment, complete quality control processes for all the products.

Professional analysis

Robocell Machining optimization service, to let you be on the top by using professional machining methods



Complete service

- Single window process
- Professional team
- Instant solution
- Quick service



High Efficiency Solutions for Aerospace Components

A perfect demonstration for machining accuracy and ability.

Hartford 5-axis double column machining center suits for complex multi axis components whilst maintaining high precision and excellent material removal efficiency



1. Aerospace component



2. Hood

NCG-2005 5-axis Accuracy Testing

■ Workpiece name	NCG2005	■ Workpiece material	Necuron 1007	■ Workpiece size	75x105x50 mm
■ Workpiece fixed angle	0° & 30°	■ Cycle time	12 min	■ Tool	Ø6 mm end mill

Dimensional accuracy



Marginal lines(1 mm) in X, Y-axis are consistent.

N/C Thermal elongation check



Connection wall thickness down to 10 μm is not broken.

Angle accuracy deviation of rotating axes



High angle accuracy of B/C axes is easily recognized by surface finish and spacing symmetry.

Workpiece surface check



Accurate right angle between X & Y plane.

Axis accuracy check



In hole cutting, tool feeds in right and left direction are symmetrical.

Contour accuracy check



By the high accuracy of contour.

Tool center point check



Tool center point in 5-axis (X,Y,Z,B,C) positions accurately.

The Optimized Structure Design on 5BC

Hartford 5BC machining center delivers the power and versatility cutting capability, Providing the best resolution for aerospace industry.



Full range of linear guideway five-year warranty:

Warranty coverage will not apply under following conditions
 1.Improper operation (collision)
 2.Lack of regular cleaning of accumulated debris causing damage to the linear rails & carriages.



Four linear guideways on Z-axis

- Supported by high rigidity roller type linear guideways.
- Bilateral supported delivers higher rigidity.
- Provides higher stability and accuracy.
- Patent (1264343 : Four linear guideways on Z-axis.)



Slant beam design on cross beam

- 45 ° Force flow design reducing vibration through efficient force flow transfer.
- Increased machine stability.
- Increased machine cutting accuracy.
- Patent (M435318: Slant beam design on double column cross beam)

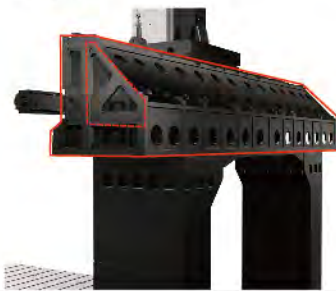

One-piece wider column design

- Increased contact area the column and the machine base to **1250mm**.
- This provides a more efficient delivery of cutting force to the machine base.
- Multi-layer box-in-box ribs structure design.
- Reduce vibration to improve your accuracy.
- Patent(M437316:The section of box type structure features excellent torsion-resistance.)



Hartford-Made High Rigidity Head & Structure

X,Y-axis ballscrew supported

- Ballscrews downcast problem can be improved.
- Enhance machining accuracy.
- Y-axis: x29/x34/x38/x42 are standard,x26 are optional.
- X-axis : Machines above 5 meter are standard, machines under 5 meter are optional.

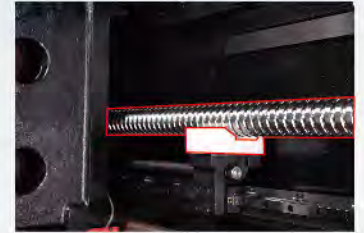
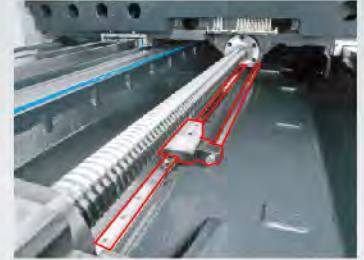

Hartford-made high rigidity 5-axis head

- The 5-axis head is made in Taiwan.
- High rigidity **FORK** structure design.
- High accuracy & high rigidity 5-axis head



High rigidity & strength machine head stock

- The size of machine head section is **540x521mm**
- Chamfer design inside the stock
- Machine head rigidity and strength can be boosted.



Measurement Equipment

The advanced measurement technique

- Dynamic collision monitoring (DCM) function increases machine running safety.
- CYCLE 451 measurement can be operated easily so that machine accuracy is always maintained.
- Heidenhain TS460+KKH250 are standard.



Dynamic collision monitoring(DCM)

- Automatically monitors the working space of machine.
- Prevents collision with components.
- Increases the level of safety for both the operator and machine.

Kinematic Comp(opt.)

- This technology takes volumetric compensation to a new level.
- Enhances precision machining of large workpiece.

Kinematic Opt 48

- It's a 3-D touch probe cycle that automatically measures all rotary axes.
- This makes recalibration a fast and efficient process.
- Machine accuracy can be controlled even over long period.

Powerful spindle torque

	Model	ITRI-5A63				CYTEC_M21		
		HSK-A63(Spindle)	B	C	HSK-A100(Spindle)	B	C	
Rotation range	degree	-	-	±105°	±240°	-	±110°	±360°
Positioning accuracy	sec	-	-	±5"	±5"	-	±5"	±2"
Rotation speed	rpm	15000	24000	60	60	12000	60	60
Rotation torque(Con.)	Nm	70.4	72	648	638	170	700	700
	ft-lbs	51.92	53.1	477.94	470.56	125.39	516.29	516.29
Rotation torque(Max.)	Nm	88.3	88	1200	1000	220	1000	1000
	ft-lbs	65.13	64.91	885.07	737.56	162.26	737.56	737.56
Holding torque	Nm	-	-	4000	4000	-	4000	4000
	ft-lbs	-	-	2950.25	2950.25	-	2950.25	2950.25

Spindle diagram

HSK-A63
15,000 rpm

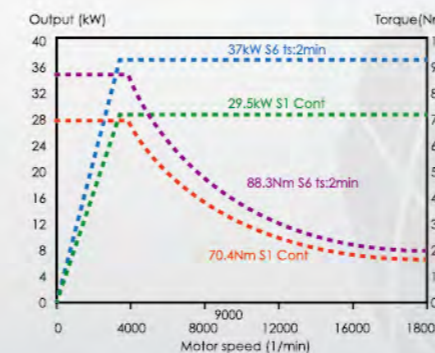
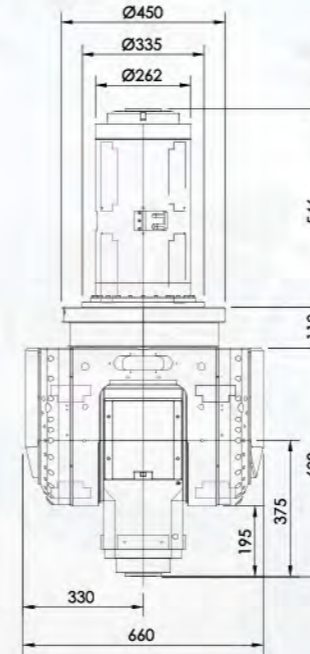

HSK-A63
24,000 rpm

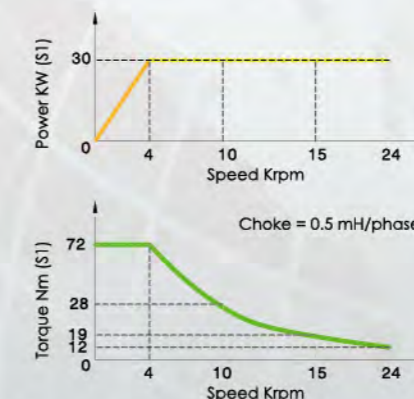
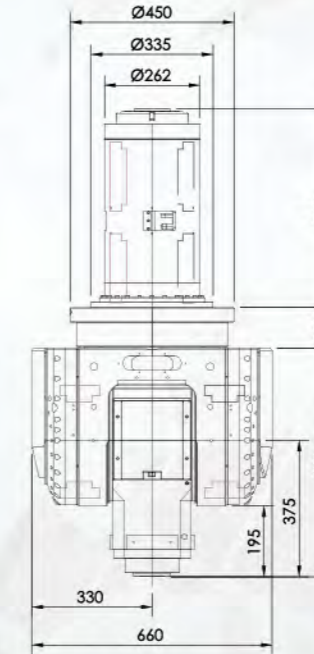

HSK-A100
12,000 rpm

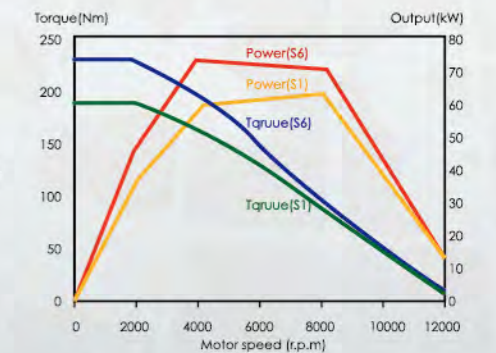
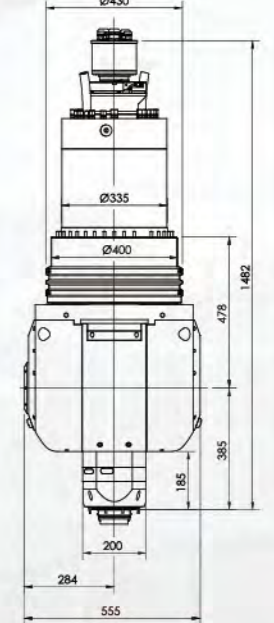

5BC Pyramid RMP600 Precision measuring

5-axis accuracy test: NAS-975



- ① 3-axis < 0.01mm
5-Axis Head Bo, Co, 3 Axis Machining accuracy
- ② 5-axis < 0.02mm
Precision when 5 Axis head at C/Axis
- ③ 3-axis < 0.01mm
5-Axis Head Bo, Co, Repetitive Accuracy
- ④ 5-axis < 0.02mm
Precision when 5 Axis head at C Axis

NO.	Machining Accuracy	Actual length		Std. length		Error margin	
		X-axis	Y-axis	X-axis	Y-axis	X-axis	Y-axis
1	3-axis >0.01mm	34.6061	41.6073	34.6	41.6	-0.0061	-0.0073
2	5-axis >0.02mm	71.4207	80.4093	71.4	80.4	-0.0207	-0.0093
3	3-axis >0.01mm	112.6049	121.6025	112.6	121.6	-0.0049	-0.0025
4	5-axis >0.02mm	151.2162	160.2055	151.2	160.2	-0.0162	-0.0055

Unit : mm

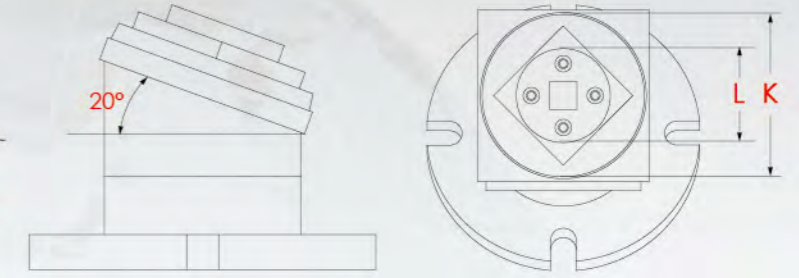
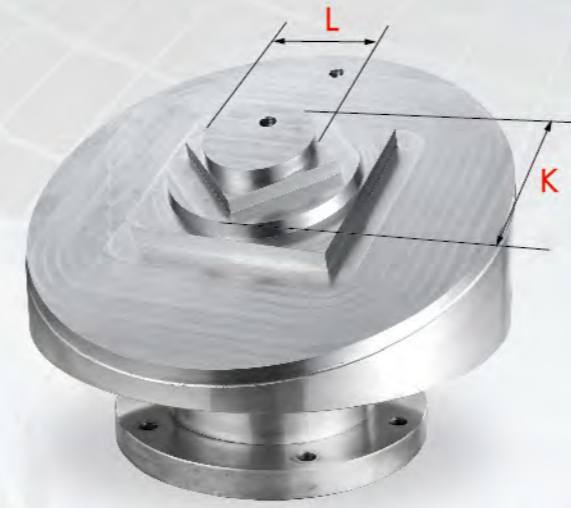

Unit:mm

Item	Test Item	Tolerance	Test Results
1	Roundness	L	0.0037
2	Roundness	K	0.0069
3	Inclination Ansgle	20° ±1' 20"	19° 58' 48"

NAS-979 Inspection Cutting report

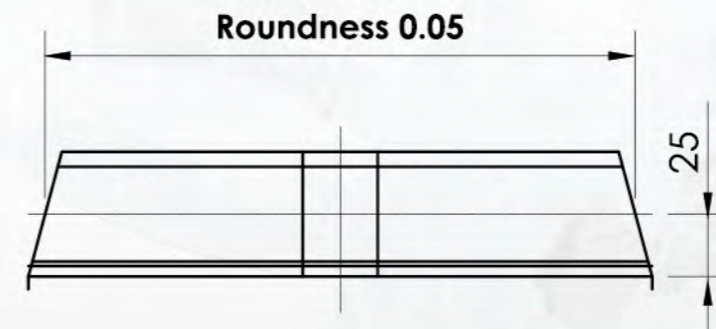

	Tolerance	Test results
Inclination angle	$\angle 15^\circ (\pm 1^\circ / 20'')$	15.0007°
Roundness	0.05	0.0148

Unit:mm



All the test results featured in this catalogue were produced under strict testing condition in a special zed testing environment. Under different testing conditions and less than ideal testing environments. That the test results may vary from those shown in this catalogue.

Automation/ Intelligent
 Application program
 Key technology
 Specification parameter

Machine Dimension

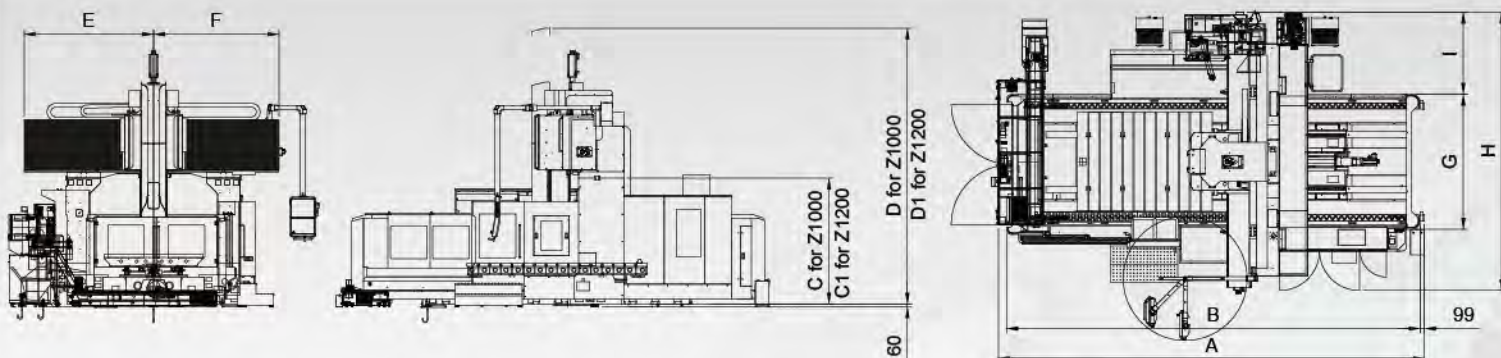

Cutting Range

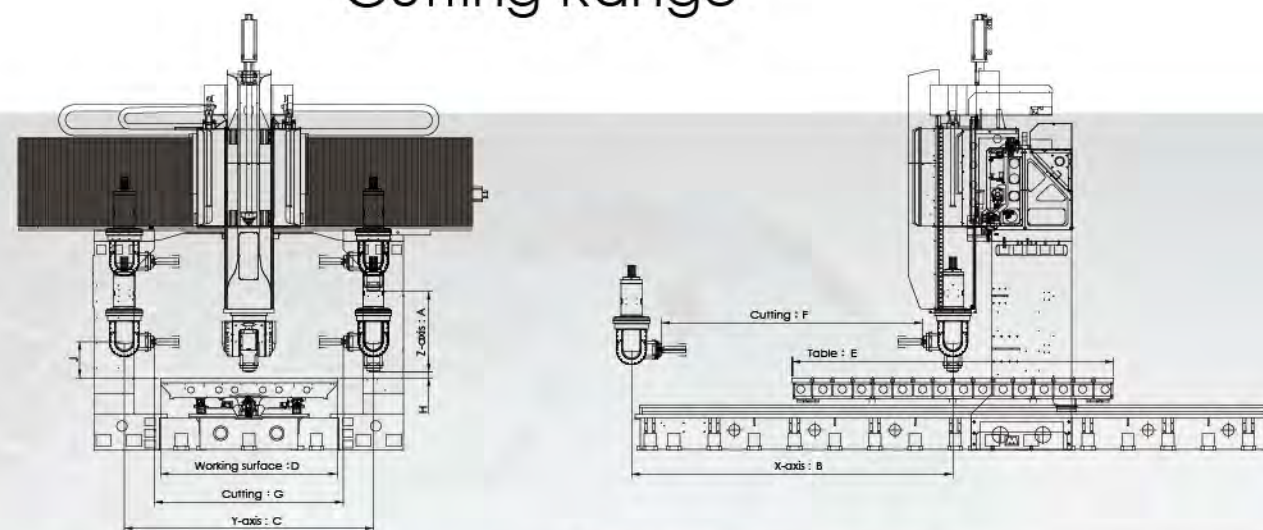

Model	A	B	C	C1	D	D1	E	F	G	H	I	
5BC-226	9068	8255	2600	2800	5930	6130	2379	2279	2194	5387	1830	HSK-A63
			2800	3000	6130	6330				5487	1930	HSK-A100(CYTEC)
5BC-326	9468	9188	2600	2800	5930	6130	2379	2279	2194	5387	1830	HSK-A63
			2800	3000	6130	6330				5487	1930	HSK-A100(CYTEC)
5BC-426	11076	10796	2600	2800	5930	6130	2379	2279	2194	5387	1830	HSK-A63
			2800	3000	6130	6330				5487	1930	HSK-A100(CYTEC)
5BC-329	9468	9188	2600	2800	5930	6130	2624	2533	2494	5687	1830	HSK-A63
			2800	3000	6130	6330				5787	1930	HSK-A100(CYTEC)
5BC-429	11076	10796	2600	2800	5930	6130	2624	2533	2494	5687	1830	HSK-A63
			2800	3000	6130	6330				5787	1930	HSK-A100(CYTEC)
5BC-529	13076	12796	2600	2800	5930	6130	2624	2533	2494	5687	1830	HSK-A63
			2800	3000	6130	6330				5787	1930	HSK-A100(CYTEC)
5BC-629	15076	14796	2600	2800	5930	6130	2624	2533	2494	5687	1830	HSK-A63
			2800	3000	6130	6330				5787	1930	HSK-A100(CYTEC)
5BC-334	9468	9188	2600	2800	5930	6130	2873	2784	2994	6187	1830	HSK-A63
			2800	3000	6130	6330				6287	1930	HSK-A100(CYTEC)
5BC-434	11076	10796	2600	2800	5930	6130	2873	2784	2994	6187	1830	HSK-A63
			2800	3000	6130	6330				6287	1930	HSK-A100(CYTEC)
5BC-534	13076	12796	2600	2800	5930	6130	2873	2784	2994	6187	1830	HSK-A63
			2800	3000	6130	6330				6287	1930	HSK-A100(CYTEC)
5BC-634	15076	14796	2600	2800	5930	6130	2873	2784	2994	6187	1830	HSK-A63
			2800	3000	6130	6330				6287	1930	HSK-A100(CYTEC)
5BC-438	11076	10796	2600	2800	5930	6130	3073	2984	3394	6587	1830	HSK-A63
			2800	3000	6130	6330				6687	1930	HSK-A100(CYTEC)
5BC-538	13076	12796	2600	2800	5930	6130	3073	2984	3394	6587	1830	HSK-A63
			2800	3000	6130	6330				6687	1930	HSK-A100(CYTEC)
5BC-638	15076	14796	2600	2800	5930	6130	3073	2984	3394	6587	1830	HSK-A63
			2800	3000	6130	6330				6687	1930	HSK-A100(CYTEC)
5BC-738	17076	16796	2600	2800	5930	6130	3073	2984	3394	6587	1830	HSK-A63
			2800	3000	6130	6330				6687	1930	HSK-A100(CYTEC)
5BC-838	19076	18796	2600	2800	5930	6130	3073	2984	3394	6587	1830	HSK-A63
			2800	3000	6130	6330				6687	1930	HSK-A100(CYTEC)
5BC-442	11076	10796	2600	2800	5930	6130	3273	3184	3794	6987	1830	HSK-A63
			2800	3000	6130	6330				7087	1930	HSK-A100(CYTEC)
5BC-542	13076	12796	2600	2800	5930	6130	3273	3184	3794	6987	1830	HSK-A63
			2800	3000	6130	6330				7087	1930	HSK-A100(CYTEC)
5BC-642	15076	14796	2600	2800	5930	6130	3273	3184	3794	6987	1830	HSK-A63
			2800	3000	6130	6330				7087	1930	HSK-A100(CYTEC)
5BC-742	17076	16796	2600	2800	5930	6130	3273	3184	3794	6987	1830	HSK-A63
			2800	3000	6130	6330				7087	1930	HSK-A100(CYTEC)
5BC-842	19076	18796	2600	2800	5930	6130	3273	3184	3794	6987	1830	HSK-A63
			2800	3000	6130	6330				7087	1930	HSK-A100(CYTEC)

Unit: mm

Model	A	B	C	D	E	F	ITIR-5A65 HSK-A63		CYTEC-M21 HSK-A100				
							G	H	J	F	G	H	J
5BC-226	1000/ 1200	2000	2600	1800	2000	1250	1850	75	450	1230	1830	190	575
5BC-326		3000			3000	2250				2230			
5BC-426		4000			4000	3250				3230			
5BC-329		3000	2900	2200	3000	2250	2150	75	450	2230	2130	190	575
5BC-429		4000			4000	3250				3230			
5BC-529		5000	3400	2200	5000	4250	2650	75	450	4230	2630	190	575
5BC-629		6000			6000	5250				5230			
5BC-334		3000	3400	2200	3000	2250	2650	75	450	2230	2630	190	575
5BC-434		4000			4000	3250				3230			
5BC-534		5000	3800	2500	5000	4250	3050	75	450	4230	3030	150	535
5BC-634		6000			6000	5250				5230			
5BC-438		4000	4200	3000	4000	3250	3450	75	450	3230	3430	150	535
5BC-538		5000			5000	4250				4230			
5BC-638		6000	4200	3000	6000	5250	3450	75	450	5230	3430	150	535
5BC-738		7000			7000	6250				6230			
5BC-838		8000	4200	3000	8000	7250	3450	75	450	7230	3430	150	535
5BC-442	4000	4000			3250	3230							
5BC-542	5000	4200	3000	5000	4250	3450	75	450	4230	3430	150	535	
5BC-642	6000			6000	5250				5230				
5BC-742	7000	4200	3000	7000	6250	3450	75	450	6230	3430	150	535	
5BC-842	8000			8000	7250				7230				

Unit: mm

Machine Specifications

Model	Unit	5BC-226/326/426	5BC-329/429/529/629	5BC-334/434/534/634	5BC-438/538/638/738/838	5BC-442/542/642/742/842
Table						
Working surface	mm	2000/3000/4000x1800	3000/4000/5000/6000x2200	3000/4000/5000/6000x2200	3000/4000/5000/6000/7000/8000x2500	4000/5000/6000/7000/8000x3000
T-slot(Size x Number x Pitch)	mm	22x7/11/15 x250	28x11/15/19/23 x250	28x11/15/19/23 x250	28x15/19/23/27/31 x250	28x15/19/23/27/31 x250
Max. table load	kg	8000/10000/12000	10000/12000/15000/18000	10000/12000/15000/18000	18000/20000/23000/25000/27000	18000/21000/24000/27000/30000
Travel						
Longitudinal travel(X-axis)	mm	2000/3000/4000	3000/4000/5000/6000	3000/4000/5000/6000	4000/5000/6000/7000/8000	4000/5000/6000/7000/8000
Cross travel (Y-axis)	mm	2600	2900	3400	3800	4200
Vertical travel (Z-axis)	mm	1000/1200	1000/1200	1000/1200	1000/1200	1000/1200
Distance from spindle end to table	mm	Z1000 : 75~1075(ITRI-5A63) Z1000 : 190~1190(CYTEC_HSK-A100) Z1200 : 75~1275(ITRI-5A63) Z1200 : 190~1390(CYTEC_HSK-A100)	Z1000 : 75~1075(ITRI-5A63) Z1000 : 190~1190(CYTEC_HSK-A100) Z1200 : 75~1275(ITRI-5A63) Z1200 : 190~1390(CYTEC_HSK-A100)	Z1000 : 75~1075(ITRI-5A63) Z1000 : 190~1190(CYTEC_HSK-A100) Z1200 : 75~1275(ITRI-5A63) Z1200 : 190~1390(CYTEC_HSK-A100)	Z1000 : 35~1035(ITRI-5A63) Z1000 : 150~1150(CYTEC_HSK-A100) Z1200 : 35~1235(ITRI-5A63) Z1200 : 150~1350(CYTEC_HSK-A100)	Z1000 : 35~1035(ITRI-5A63) Z1000 : 150~1150(CYTEC_HSK-A100) Z1200 : 35~1235(ITRI-5A63) Z1200 : 150~1350(CYTEC_HSK-A100)
Distance from spindle center to column	mm	480	480	480	480	480
Width between column	mm	2000	2300	2800	3200	3600
Spindle						
Spindle drive motor	Kw (S1/S6)	29.5/37(ITRI-5A63,SETCO_HSK-A63_15000rpm) 30/37(ITRI-5A63,PERON SPEED_HSK-A63_24000rpm) 34/43(CYTEC,CS-34-180-S_HSK-A100_12000rpm)	29.5/37(ITRI-5A63,SETCO_HSK-A63_15000rpm) 30/37(ITRI-5A63,PERON SPEED_HSK-A63_24000rpm) 34/43(CYTEC,CS-34-180-S_HSK-A100_12000rpm)	29.5/37(ITRI-5A63,SETCO_HSK-A63_15000rpm) 30/37(ITRI-5A63,PERON SPEED_HSK-A63_24000rpm) 34/43(CYTEC,CS-34-180-S_HSK-A100_12000rpm)	29.5/37(ITRI-5A63,SETCO_HSK-A63_15000rpm) 30/37(ITRI-5A63,PERON SPEED_HSK-A63_24000rpm) 34/43(CYTEC,CS-34-180-S_HSK-A100_12000rpm)	29.5/37(ITRI-5A63,SETCO_HSK-A63_15000rpm) 30/37(ITRI-5A63,PERON SPEED_HSK-A63_24000rpm) 34/43(CYTEC,CS-34-180-S_HSK-A100_12000rpm)
Spindle Rated Torque	Nm(S1/S6)	70.4/88.3(ITRI-5A63,SETCO_HSK-A63_15000rpm) 72/88(ITRI-5A63,PERON SPEED_HSK-A63_24000rpm) 170/220(CYTEC,CS-34-180-S_HSK-A100_12000rpm)	70.4/88.3(ITRI-5A63,SETCO_HSK-A63_15000rpm) 72/88(ITRI-5A63,PERON SPEED_HSK-A63_24000rpm) 170/220(CYTEC,CS-34-180-S_HSK-A100_12000rpm)	70.4/88.3(ITRI-5A63,SETCO_HSK-A63_15000rpm) 72/88(ITRI-5A63,PERON SPEED_HSK-A63_24000rpm) 170/220(CYTEC,CS-34-180-S_HSK-A100_12000rpm)	70.4/88.3(ITRI-5A63,SETCO_HSK-A63_15000rpm) 72/88(ITRI-5A63,PERON SPEED_HSK-A63_24000rpm) 170/220(CYTEC,CS-34-180-S_HSK-A100_12000rpm)	70.4/88.3(ITRI-5A63,SETCO_HSK-A63_15000rpm) 72/88(ITRI-5A63,PERON SPEED_HSK-A63_24000rpm) 170/220(CYTEC,CS-34-180-S_HSK-A100_12000rpm)
Spindle speed	rpm	15000/24000(HSK-A63) 12000(HSK-A100)	15000/24000(HSK-A63) 12000(HSK-A100)	15000/24000(HSK-A63) 12000(HSK-A100)	15000/24000(HSK-A63) 12000(HSK-A100)	15000/24000(HSK-A63) 12000(HSK-A100)
Spindle nose tape		HSK-A63/HSK-A100	HSK-A63/HSK-A100	HSK-A63/HSK-A100	HSK-A63/HSK-A100	HSK-A63/HSK-A100
B-axis						
RPM of B-axis	rpm	60	60	60	60	60
Rotated Torque(max)	Nm	1200(ITRI-5A63) 1000(CYTEC-M21)	1200(ITRI-5A63) 1000(CYTEC-M21)	1200(ITRI-5A63) 1000(CYTEC-M21)	1200(ITRI-5A63) 1000(CYTEC-M21)	1200(ITRI-5A63) 1000(CYTEC-M21)
Braking Torque	Nm	4000(ITRI-5A63) 4000(CYTEC-M21)	4000(ITRI-5A63) 4000(CYTEC-M21)	4000(ITRI-5A63) 4000(CYTEC-M21)	4000(ITRI-5A63) 4000(CYTEC-M21)	4000(ITRI-5A63) 4000(CYTEC-M21)
B-axis travel	degree	±105°(ITRI-5A63)±110°(CYTEC-M21)	±105°(ITRI-5A63)±110°(CYTEC-M21)	±105°(ITRI-5A63)±110°(CYTEC-M21)	±105°(ITRI-5A63)±110°(CYTEC-M21)	±105°(ITRI-5A63)±110°(CYTEC-M21)
Precision of Positioning		±5"	±5"	±5"	±5"	±5"
C-axis						
RPM of B-axis	rpm	60	60	60	60	60
Rotated Torque(max)	Nm	1000(ITRI-5A63) 1000(CYTEC-M21)	1000(ITRI-5A63) 1000(CYTEC-M21)	1000(ITRI-5A63) 1000(CYTEC-M21)	1000(ITRI-5A63) 1000(CYTEC-M21)	1000(ITRI-5A63) 1000(CYTEC-M21)
Braking Torque	Nm	4000(ITRI-5A63) 4000(CYTEC-M21)	4000(ITRI-5A63) 4000(CYTEC-M21)	4000(ITRI-5A63) 4000(CYTEC-M21)	4000(ITRI-5A63) 4000(CYTEC-M21)	4000(ITRI-5A63) 4000(CYTEC-M21)
C-axis travel	degree	±240°(ITRI-5A63) ±360°(CYTEC-M21)	±240°(ITRI-5A63) ±360°(CYTEC-M21)	±240°(ITRI-5A63) ±360°(CYTEC-M21)	±240°(ITRI-5A63) ±360°(CYTEC-M21)	±240°(ITRI-5A63) ±360°(CYTEC-M21)
Precision of Positioning		±5"(ITRI-5A63) ±2"(CYTEC-M21)	±5"(ITRI-5A63) ±2"(CYTEC-M21)	±5"(ITRI-5A63) ±2"(CYTEC-M21)	±5"(ITRI-5A63) ±2"(CYTEC-M21)	±5"(ITRI-5A63) ±2"(CYTEC-M21)
Feed						
Cutting feed rate(X/Y/Z axis)	m/min	X/Y/Z : 12	X: 12/10/8/8 Y/Z : 12	X: 12/10/8/8 Y/Z : 12	X: 10/8/8/8/6 Y/Z : 12	X: 10/8/8/8/6 Y/Z : 10
Rapid traverse(X/Y/Z axis)	m/min	X: 24/20/20 Y:18 Z:16	X: 20/20/14/12 Y : 18 Z : 16	X: 20/20/14/12 Y : 18 Z : 16	X: 16/12/10/10/8 Y : 18 Z : 16	X: 16/14/12/10/8 Y : 16 Z : 16
ATC						
Tool storage capacity	Pcs	32/40、60(A-Type)	32/40、60(A-Type)	32/40、60(A-Type)	32/40、60(A-Type)	32/40、60(A-Type)
Max. tool weight	Kg	7(HSK-A63) 20(HSK-A100)	7(HSK-A63) 20(HSK-A100)	7(HSK-A63) 20(HSK-A100)	7(HSK-A63) 20(HSK-A100)	7(HSK-A63) 20(HSK-A100)
Max. tool size(diameter x length)	mm	ø75x300(HSK-A63) ø125x400(HSK-A100)	ø75x300(HSK-A63) ø125x400(HSK-A100)	ø75x300(HSK-A63) ø125x400(HSK-A100)	ø75x300(HSK-A63) ø125x400(HSK-A100)	ø75x300(HSK-A63) ø125x400(HSK-A100)
Positioning Accuracy						
3- axes laser positioning accuracy(JIS B6330)						
Positioning accuracy / Full travel	mm	±0.010	±0.010 /±0.010	±0.010 /±0.010/0.012/0.012	±0.012	±0.012
Repetitive positioning accuracy	mm	±0.003	±0.003	±0.003	±0.003	±0.003
3-axes laser positioning accuracy (VDI 3441)/repeated 5 times						
Positioning accuracy	mm	0.015/0.016/0.018	0.016/0.018	0.016/0.018/0.026/0.028	0.018/0.026/0.028/0.028/0.030	0.018/0.026/0.028/0.028/0.030
Repetitive positioning accuracy	mm	0.014/0.014/0.015	0.014/0.015	0.014/0.015/0.021/0.024	0.015/0.021/0.024/0.024/0.026	0.015/0.021/0.024/0.024/0.026
Other						
Coolant Capacity(L)	L	640	700	800	920	1020
Required Air Pressure	kg/cm ²	6.5	6.5	6.5	6.5	6.5
Distance From Table Surface To Floor	mm	960	960	960	1000	1000
Machine Height	mm	6020(HSK-A63) 6220(HSK-A100)	6020(HSK-A63) 6220(HSK-A100)	6020(HSK-A63) 6220(HSK-A100)	6020(HSK-A63) 6220(HSK-A100)	6020(HSK-A63) 6220(HSK-A100)
Floor space (Full Guarding)	mm	10417/11417/13007x6940	11567/13157/15157/17157 x7240	11817/13425/15425/17425 x7740	13625/15625/17625/19625/21625 x8140	13825/15825/17825/19825/21825x8540
Machine Weight	kg	29000/33000/37000	35000/39000/42000/46000	39000/45000/50000/55000	48000/55000/62000/69000/76000	54000/62000/70000/78000/87000

VDI 3441 accuracy available upon order request.