

Right

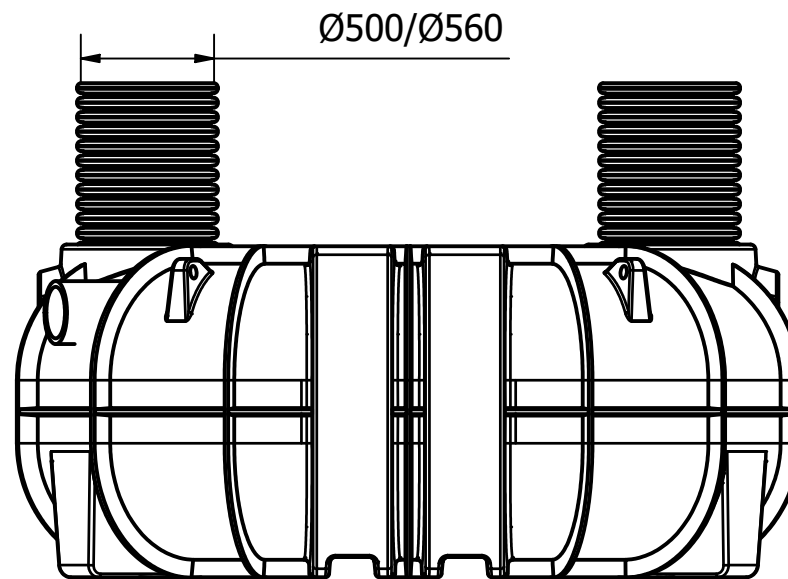

Front

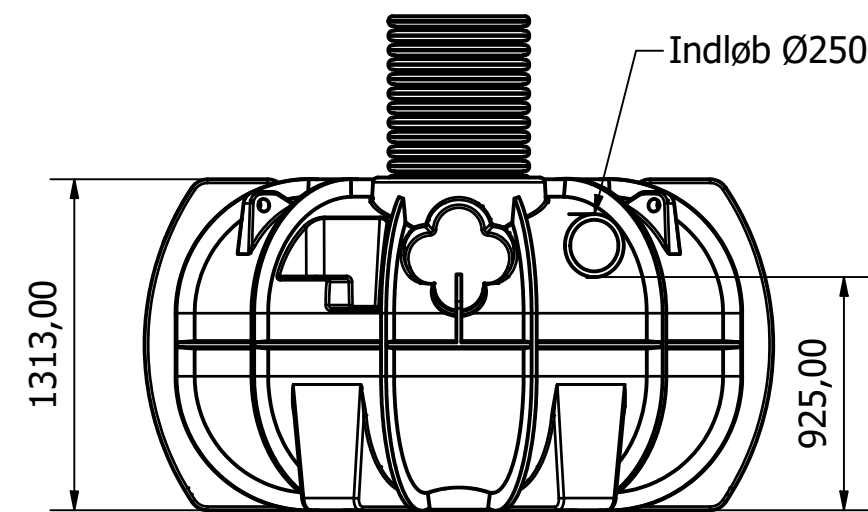

Left

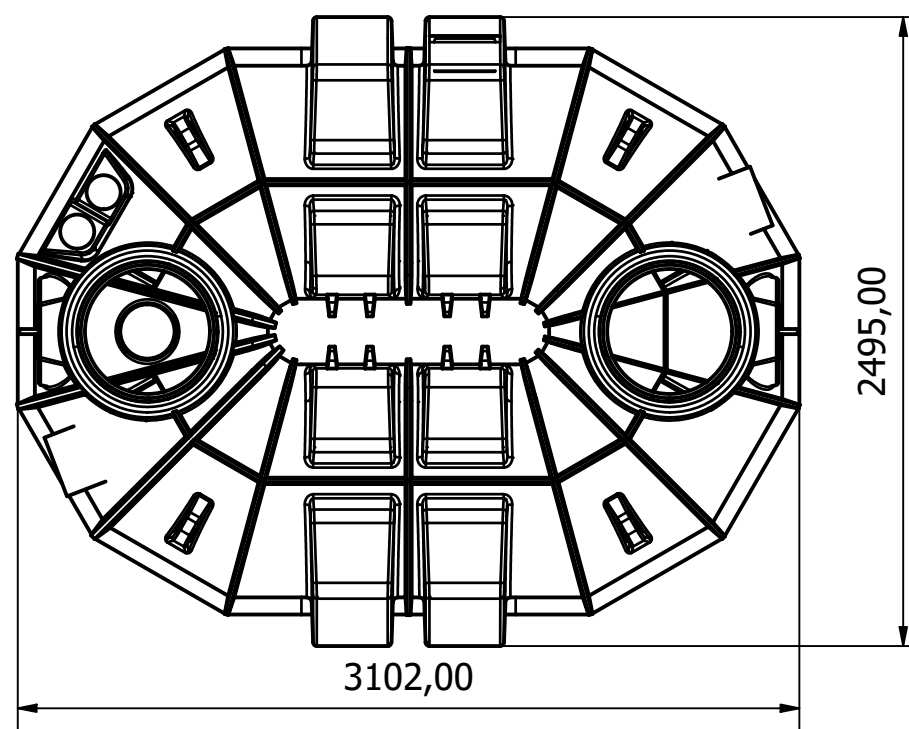

Top

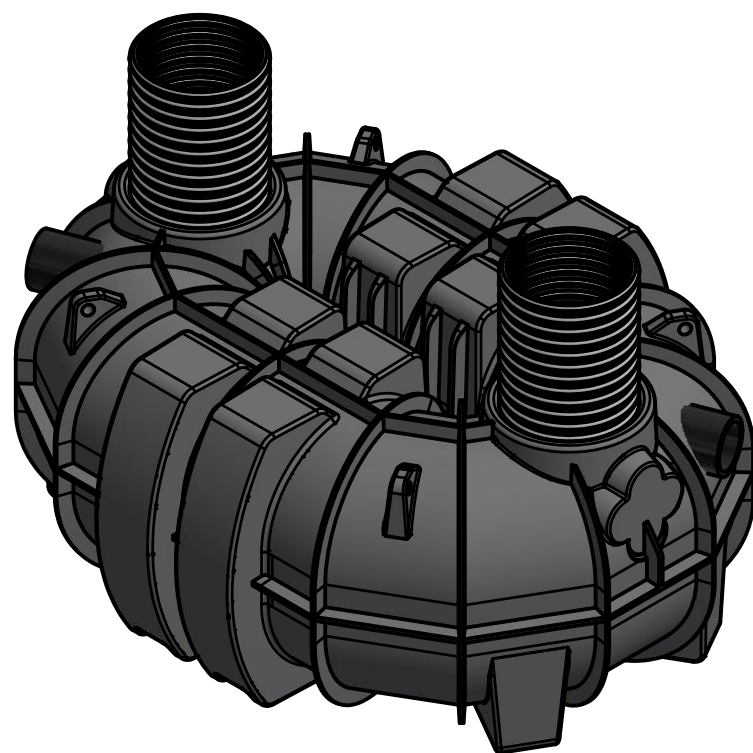

Denne tegning må ikke kopieres, forevises andre firmaer og personer eller anvendes på en måde, som strider mod WaterCare's interesser.

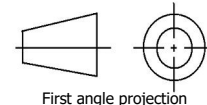

First angle projection

Tlf. Watercare:  
70 25 65 37

Varenummer / Projekt

Info  
Alle mål i mm ± 3% afvigelse

Ark  
1 / 1

**waterCare**

Titel  
Sandfang

Størrelsesforhold  
1:30

Volumen / kapacitet  
3,95 m<sup>3</sup>

Dato  
12-04-2019

Format  
A3