USER MANUAL

DragonTouch Vision 3 Action Camera

English 01 - 23

Deutsch 24- 32

Español 33- 41

Français 42 - 50

Italiano 51 - 59

日本語 60 - 68

CONTENTS

| | |
|--|----|
| YOUR VISION 3 | 02 |
| GETTING STARTED | 04 |
| OVERVIEW OF MODES | 05 |
| CUSTOMIZING YOUR VISION 3 | 09 |
| CONNECTING TO THE XDV APP | 13 |
| PLAYING BACK YOUR CONTENT | 13 |
| DELETING VIDEOS AND PHOTOS ON YOUR VISION 3 | 14 |
| TRANSFERRING YOUR DATA | 14 |
| TRANSFERRING YOUR DATA TO A SMARTPHONE OR TABLET | 16 |
| ADJUSTING THE ZOOM LEVEL | 16 |
| REFORMATTING YOUR MEMORY CARD | 16 |
| MAINTAINING YOUR CAMERA | 17 |
| EXTENDING BATTERY LIFE | 17 |
| BATTERY STORAGE AND OPERATION | 17 |
| REMOTE | 18 |
| ACCESSORIES | 20 |
| MOUNTING YOUR CAMERA | 21 |
| CONTACT US | 23 |

YOUR VISION 3

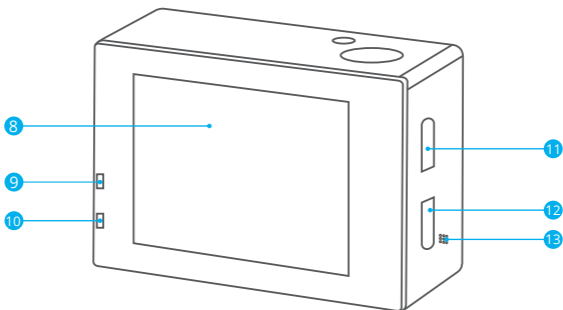
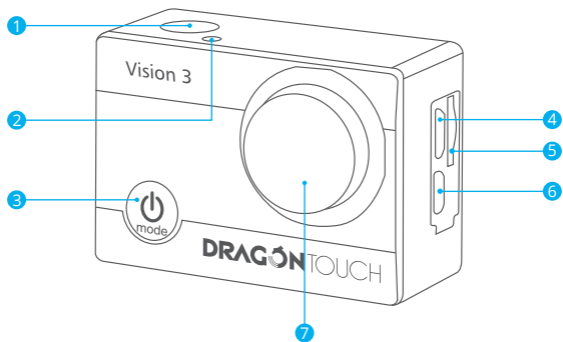

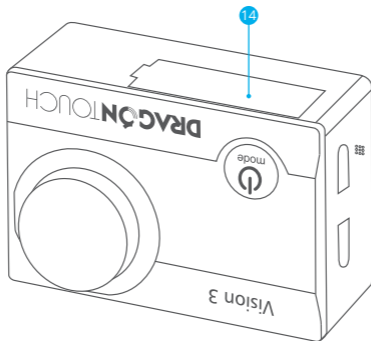

- | | |
|------------------------------|----------------------|
| ① Shutter / Select Button | ⑧ Screen |
| ② Wifi indicator | ⑨ Charging Indicator |
| ③ Power / Mode / Exit Button | ⑩ Working Indicator |
| ④ Micro USB Port | ⑪ Up Button |
| ⑤ Memory Card Slot | ⑫ Down Button |
| ⑥ Micro HDMI Port | ⑬ Speaker |
| ⑦ Lens | ⑭ Battery Cover |

Note: The camera will not record sound when it is in the waterproof case.

GETTING STARTED

Welcome to your new Vision 3. To capture videos and photos, you need a memory card (not included).

MEMORY CARDS

Use brand name memory cards that meet these requirements:

- Class 10 or UHS-I rating
- Capacity up to 64GB (FAT32)

Note:

1. Before using this camera, please format the memory card first. To keep your memory card in good condition, reformat it on a regular basis. Reformatting deletes all of your data, so be sure to transfer your photos and videos first.
2. The FAT32 format memory card will stop recording when the storage of each file exceeds 4GB and start to record again in a new file.

POWERING ON AND OFF

To Power On:

Long press the Mode button for three seconds. The camera will beep and the status light will be on. When information appears on the LCD display or the camera status screen, your camera is on.

To Power Off:

Long press the Mode button for three seconds. The camera will beep and the status light will be off.

SWITCHING MODES

To Switch Modes:

Turn on the camera and press the Mode button to switch modes.

To Exit a Mode:

Press the Mode button to exit a mode.

TURNING Wifi ON / OFF

To turn on Wifi

Turn on the camera and press and hold the Up button to turn on Wifi. You can also enter Camera Settings to turn on Wifi.

To turn off Wifi

Press the Up button to turn off Wifi.

Note: The camera will not record sound when it is in the waterproof case.

OVERVIEW OF MODES

There are eight modes: Video, Photo, Slow Motion, Playback, Video Settings, Photo Settings, Camera Settings and General Settings.

Video Mode

Video Mode is the default mode when you turn on the camera.

In Video Mode, press the OK button to start recording. Press the OK button again to stop recording.

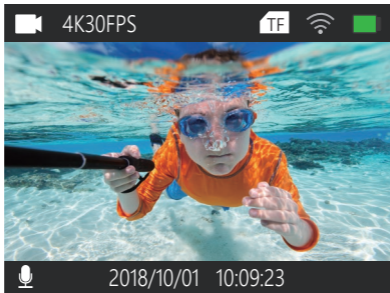

Photo Mode

Press the Mode button once to switch to Photo Mode after you turn on the camera. In Photo Mode, press the OK button to take a photo.



Slow Motion Mode

Press the Mode button twice to switch to Slow Motion Mode after you turn on the camera.

In Slow Motion Mode, press the OK button to start recording a video in slow motion. Press the OK button again to stop recording.



Playback Mode

Press the Mode button several times to switch to Playback Mode.

In Playback Mode, press the Up/ Down button to select video or photo files.

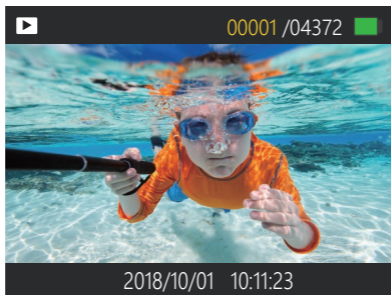

Video Settings Mode

Press the Mode button several times to switch to Video Settings Mode. You can change video settings in this mode.

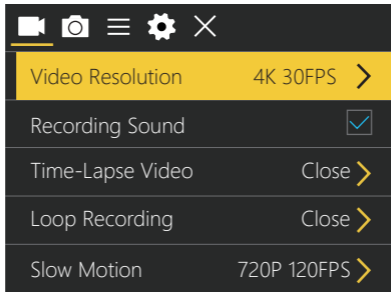
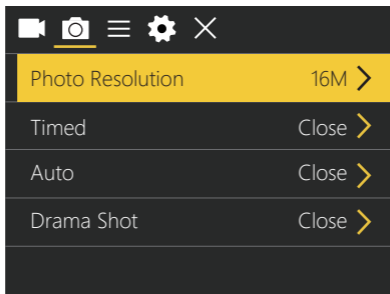

Photo Settings Mode

Press the Mode button several times to switch to Photo Settings Mode. You can change photo settings in this mode.



General Settings Mode

Press the Mode button several times to switch to General Settings Mode. You can change general settings in this mode.

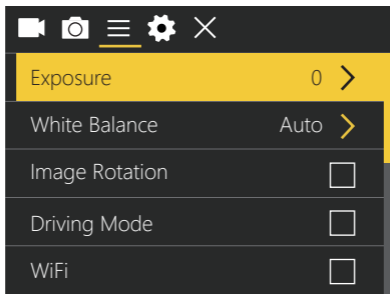

Camera Settings Mode

Press the Mode button several times to switch to Camera Settings Mode. You can change camera settings in this mode.

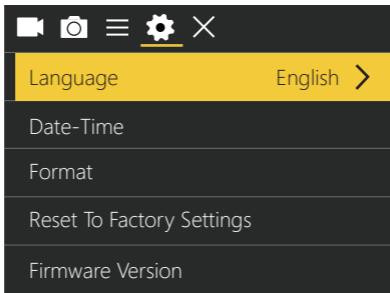

CUSTOMIZING YOUR VISION 3

Video Setting

1. Video Resolution: 4K 30FPS, 2.7K 30FPS, 1080P 60FPS, 1080P 30FPS, 720P 120FPS, 720P 60FPS, 720P 30FPS (Default: 4K 30FPS)

2. Recording Sound: On / Off (Default: On)

Turn off Recording Sound and the camera will not record sound when you record video.

3. Time-lapse: Closed / 0.5s / 1s / 2s / 5s / 10s / 30s / 60s (Default: Closed)

With the Time-lapse feature, a series of photos will be captured at specified intervals. Use this feature to capture photos of any activity, then choose the best one later.

Note: Time-lapse video is captured without audio.

4. Loop Recording: Closed / 1 min / 2 min / 3 min / 5 min (Default: Closed)

Loop Recording allows your camera to overwrite existing files with new files. Once the memory card is full, the camera will delete the first video file to make room for the latest file. For example, if the setting for loop recording is "1 min", then the camera will create video clips of 1 minute in length, and a 1-minute clip will be deleted when the camera requires more space.

5. Slow Motion: 720P 120FPS, 1080P 60FPS (Default: 720P 120FPS)

Slow Motion is a filmmaking effect whereby time appears to be slowed down.

Note: Slow Motion video is captured without audio.

6. Image Stabilization: On/ Off. (Default: Off)

Photo Setting

1. Photo Resolution: 20M / 16M / 12M / 8M / 5M / 2M (Default: 20M)**2. Timed:** Closed / 3s / 5s / 10s / 20s (Default: Closed)

The Timed feature gives a delay between pressing the OK button and releasing it. This is the most common way for photographers to take a photo of themselves (often with family).

3. Auto: Closed / 3s / 10s / 15s / 20s / 30s (Default: Closed)

If you select 3s, a photo will be taken automatically every 3 seconds.

4. Drama Shot: Closed, 3P/s, 5P/s, 10P/s (Default: Closed)

Drama Shot (Burst Photo) captures up to 10 photos per second, making it perfect for fast-moving activities.

Camera Settings

1. **Exposure:** -3, -2, -1, 0, 1, 2, 3 (Default: 0)

By default, your camera uses the entire image to determine the appropriate exposure level. However, depending on what you want the camera to prioritize when determining exposure, you can select a level in the Exposure setting. This is particularly useful for shots where an important region might otherwise be over- or underexposed.

When you change this setting, the LCD display will immediately show you the effect on your image. If you change the mode, the camera will revert back to using the entire image to determine the correct exposure level.

2. **White Balance:** Auto, Sunny, Cloudy, Incandescent Light, Fluorescent Light (Default: Auto)

White Balance can be used to adjust the color temperature of videos and photos and optimize it for cool or warm lighting conditions. When you change this setting, the LCD display will immediately show you the effect on your image.

3. **Wifi:** Off / On (Default: Off)

Note: You can also hold and press the Up button to turn Wifi on in Video or Photo Mode.

4. **Image Rotation:** Off / On (Default: Off)

This setting determines the orientation of your video and photos, helping to prevent upside down footage.

5. **Driving Mode:** Off / On (Default: Off)

If you turn on Driving Mode and connect the camera via the onboard cigarette lighter, the camera will turn on automatically when you start your car and turn off when you stop your car.

6. **Light Source Frequency:** Auto, 50Hz, 60Hz (Default: Auto)

7. **LED Indicator Light:** Off / On (Default: On)

8. Auto Screensaver: Closed, 10s, 20s, 30s, (Default: 30s)

Auto Screensaver turns off the LCD display after a period of inactivity to save battery life. Press any button on the camera to turn the display back on.

9. Auto Shutdown: Closed, 1 min, 3 min, 5 min (Default: 3 min)

Auto Shutdown will power off your Vision 3 after a period of inactivity to save battery life.

10. Time Watermark: Off / On (Default: On)

With Time Watermark enabled, a time and date stamp will be added to the videos and photos you take.

General Setting

1. Language: 简体中文, 繁體中文, English, 日本語, Deutsch, Français, Italiano, Español, Português, Русский, 한국어 (Default: English)

2. Date-Time: YYYY-MM-DD, HH-MM-SS

3. Format: Format memory card? Confirm / Cancel

To keep your memory card in good condition, reformat it on a regular basis. Reformatting erases all of your content, so be sure to transfer your photos and videos first.

4. Reset to Factory Settings: Reset to Factory Settings? Confirm / Cancel

This option resets all settings to their default values.

5. Firmware Version

Here, you can check the model, version, update time and manufacturer of your Vision 3.

CONNECTING TO THE XDV APP

The XDV app can be used to control your camera remotely via smartphone or tablet. Features include full camera control, live preview, playback, download, content sharing and camera settings.

1. Download the XDV app from Google Play or the Apple Store.
2. Turn on the camera and press and hold the Up button to turn on Wifi.
3. Turn on the Wifi of your mobile device and connect to the Wifi SSID "ActionCam".
4. Enter the password "1234567890".
5. Open the XDV app on your phone or tablet.

Note: This camera does not support MacBook or iPad.

PLAYING BACK YOUR CONTENT

You can play back your content on the camera's LCD display or your computer, TV, smartphone or tablet.

You can also play back content by inserting the memory card directly into a device such as a computer or compatible TV. With this method, playback resolution depends on the device and its capacity.

VIEWING VIDEOS AND PHOTOS ON YOUR VISION 3

1. Enter Playback Mode. If your memory card is very full, it might take a minute to load.
2. Press the Up / Down button to scroll through the video or photo files.

Note: This camera does not support MacBook or iPad.

DELETING VIDEOS AND PHOTOS ON YOUR VISION 3

1. Enter Playback Mode.
2. Press the Up / Down button to scroll through the video or photo files.
3. Press and hold the OK button for three seconds. The screen will display 'Delete this file / Confirm / Cancel'.
4. Press the Up button followed by the OK button, and the selected file will be deleted.
5. To exit Playback Mode, press the Mode button.

TRANSFERRING YOUR DATA

TRANSFERRING YOUR DATA TO A COMPUTER

To play back your video and photos on a computer, you must first transfer the files to a computer. Transferring can also free up space on your memory card for new files.

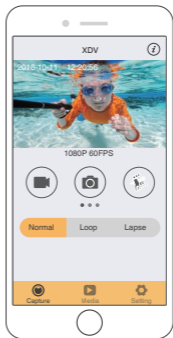
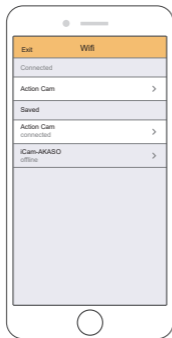

To transfer files to a computer using a card reader (sold separately) and your computer's file explorer, connect the card reader to the computer, then insert the memory card. You can now transfer files to your computer or delete selected files from your card. You can also transfer files to a Windows computer using a USB cable.

Note: This camera does not support MacBook or iPad.

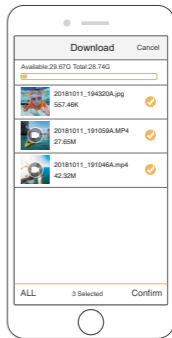
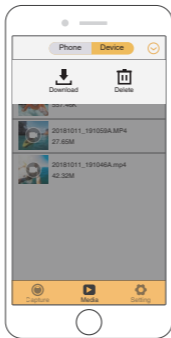
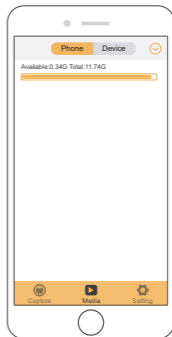
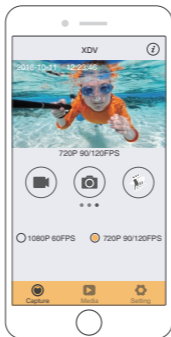
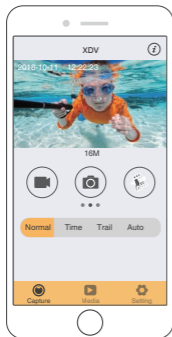



TRANSFERRING YOUR DATA TO A SMARTPHONE OR TABLET

1. Open the XDV app and select 'Action Cam'.
2. Tap the Media icon  at the bottom of screen.
3. Tap 'Device' at the top of the screen.
4. Tap  followed by  to select the file you want to download.
5. Tap 'Confirm' at the right corner of the bottom screen.

Note:

1. If you cannot transfer videos or photos to an iPhone or iPad, please enter Settings -> Privacy -> Photos, find 'XDV' and select 'Read and Write'.
2. You cannot download 4K or 2.7K videos to an iPhone or iPad via the Wifi app. Please transfer 4K or 2.7K videos via a card reader.

ADJUSTING THE ZOOM LEVEL

The Zoom function can be used to adjust how close or far away the subject appears in your photo. The default is no zoom. The Zoom function is available in Video and Photo Mode. Vision 3 is capable of 4X zoom.

1. Turn on the Vision 3.
2. Enter Video or Photo Mode.
3. Press and hold the Up or Down button to adjust the zoom level.

REFORMATTING YOUR MEMORY CARD

To keep your memory card in good condition, reformat it on a regular basis. Reformatting deletes all of your content, so be sure to transfer your photos and videos first.

1. Turn on the Vision 3.
2. Enter Camera Settings.
3. Press the Up / Down button to find the 'Format' option.
4. Press the OK button and the screen will show 'Format memory card? Confirm / Cancel'.
5. Press the Up button followed by the OK button and your memory card will be formatted successfully.

MAINTAINING YOUR CAMERA

Follow these guidelines to get the best performance from your camera:

1. For best audio performance, shake the camera or blow on the mic to remove dust or ash before use.
2. To clean the lens, wipe it with a soft lint-free cloth. Do not clean the lens with anything else.
3. Do not touch the front lens directly with your fingers.
4. Keep the camera away from drops and bumps which may cause damage to the parts inside.
5. Keep the camera away from high temperatures and strong sunlight to avoid damage.

EXTENDING BATTERY LIFE

If battery power reaches 0% while recording, the camera will save the file and power off. To maximize battery life, please follow the guidelines where possible:

- Turn off wireless connections
- Capture video at lower frame rates and resolutions
- Use the Screen Saver setting.

BATTERY STORAGE AND OPERATION

The Vision 3 camera contains fragile components including the battery. Avoid exposing your camera to extremely low or high temperatures as such conditions may temporarily shorten the battery life or cause the camera to temporarily shut down. Avoid dramatic changes in temperature or humidity when using the camera as condensation may form on or within the device.

Do not dry the camera or battery with an external heat source such as a microwave oven or hair dryer. Damage to the camera or battery caused by liquid inside the body is excluded from the warranty.

Do not store the battery with metal objects such as coins, keys or necklaces. If the battery terminals come close to metal objects, fire may be caused.

Do not make any unauthorized alterations to the camera as this may compromise safety, regulatory compliance or performance, and may void the warranty.

WARNING: Do not drop, disassemble, open, crush, bend, deform, puncture, shred, microwave, incinerate or paint the camera or battery. Do not insert foreign objects into the battery opening of the camera. Do not use the camera or battery if it has been damaged; for example, if it is cracked, punctured or damaged by water. Disassembling or puncturing the battery can cause an explosion or fire.

REMOTE

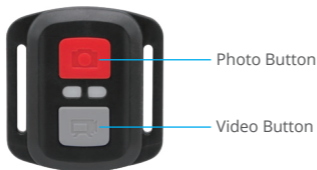

Photo Button

Video Button

Splashproof only, not waterproof.

VIDEO

To record video, put the camera in Video Mode.

To start recording:

Press the Grey Video Button. The camera will emit one beep and the camera light will flash while recording.

To stop recording:

Press the Grey Video Button again. The camera will emit one beep, the camera light will stop flashing and the camera will stop recording.

PHOTO

To capture a photo, put the camera in Photo Mode.

To take a photo:

Press the Red Photo Button. The camera will emit a camera shutter sound.

CR2032 BATTERY REPLACEMENT FOR VISION 3 REMOTE

1. Use a 1.8 mm Phillips head screwdriver to remove the four screws on the back cover of the remote, allowing you to open it.



2. Remove the other four screws in the PCB board.



3. Lift the PCB board and slide out the battery, as shown in the picture.

Note: Do NOT rotate the PCB board to avoid reversing the camera and video button functions.



4. Install the new battery, keeping the “+” pole facing up.

5. Install all four screws back into the PCB board.



6. Install all four screws back into the cover.

ACCESSORIES

| | | | | | |
|---|---|--|---|--|--|
|  Waterproof Case |  Handle Bar/ Pople Mount |  Mount 1 |  Mount 2 |  Mount 3 |  Mount 4 |
|  Mount 5 |  Mount 6 |  Mount 7 |  Bandages |  Protective Backdoor |  USB Cable |
|  Clip 1 |  Clip 2 |  Helmet Mounts |  Lens Cloth |  Tethers |  Battery & Charger |

MOUNTING YOUR CAMERA

You can attach your camera to helmets, handlebars and equipment, as follows:



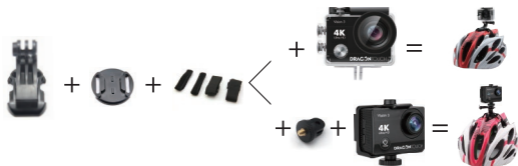
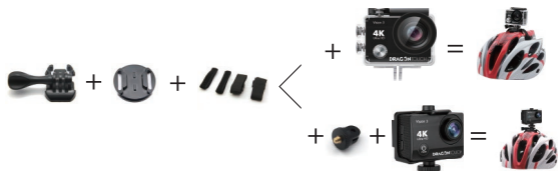

CONTACT US

For any inquiries about DragonTouch products, please feel free to contact us.
We will respond within 24 hours.

Tel: 888-811-1140 (US)

Email: cs@dragontouch.com

Web: www.dragontouch.com

INHALTE

| | |
|--------------------------|----|
| IHRE VISION 3 | 25 |
| EINLEITUNG | 27 |
| ÜBERSICHT | 27 |
| EINSTELLUNGEN | 29 |
| VIDEO MODUS | 29 |
| FOTO MODUS | 30 |
| ZEITLUPEN MODUS | 30 |
| WIEDERGABE | 30 |
| SPEICHER / SPEICHERKARTE | 31 |
| BATTERIE | 31 |
| KAMERA APP UND Wifi | 32 |
| KONTAKTIEREN SIE UNS | 32 |

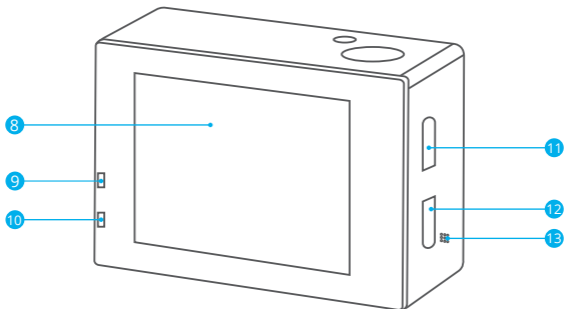
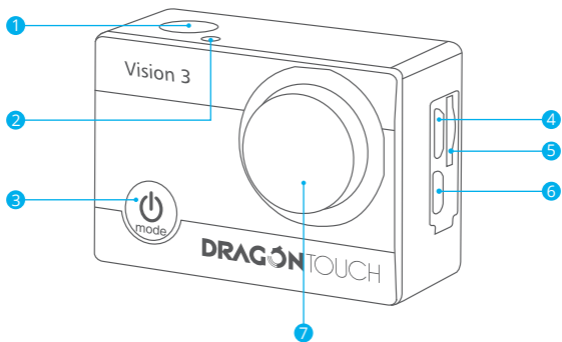

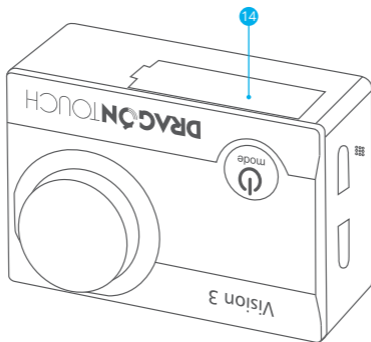

- | | | | |
|---|--------------------------------|----|----------------|
| 1 | Verschluss/ Auswahltaste | 8 | Display |
| 2 | WLAN Anzeige | 9 | Ladeanzeige |
| 3 | An-/Aus- / Menü- / Zurücktaste | 10 | Arbeitsanzeige |
| 4 | Mikro USB Port | 11 | Hoch-Taste |
| 5 | Speicherkarte Slot | 12 | Runter-Taste |
| 6 | Mikro HDMI Port | 13 | Lautsprecher |
| 7 | Linse | 14 | Batteriefach |

Notiz: Die Kamera kann während sie in der wasserfesten Schutzhülle ist, keinen Ton aufnehmen.

EINLEITUNG

HALLO

Herzlichen Glückwunsch zu Ihrer neuen Kamera! Dieses Bedienerhandbuch hilft beim Verständnis der Grundkenntnisse, wie man die unglaublichsten Momente des Lebens aufzeichnen kann!

Zum EINSCHALTEN:

Drücken Sie die Ein-Aus / Modus-Taste.

Zum AUSSCHALTEN:

Drücken und halten Sie die Ein-Aus / Modus-Taste.

ÜBERSICHT

Schalten Sie die Kamera EIN und drücken Sie mehrmals die Ein-Aus / Modus-Taste, um durch die Kamera-Modi und Einstellungen zu schalten. Die Modi erscheinen in der folgenden Reihenfolge:



Video: Video aufzeichnen

Foto: Ein Einzelbild aufnehmen

Langsame Bewegung: Ausführung für dramatische Effekte

Wiedergabe: Schauen Sie Ihr Video in einem schnellen Modus an

Impostazioni: Richten Sie die Kameraeinstellungen für die Videolösung, den Videomodus, die Fotoauflösung, den Fotomodus, die Belichtung, die Sprache, usw. ein.

| Sektion | Funktion | Spezifikation |
|--------------------------|---|---|
| Video | Video Auflösung | 1080P/60FPS, 1080P/30FPS, 720P/120FPS, 720P/60FPS, 720P/30FPS, 2.7K/30FPS, 4K/30FPS |
| | Loop-Aufnahme | 2minuten, 3minuten, 5minuten, Ausschalten |
| | Zeitraffer | Ausschalten, 0.5s , 1s, 2s , 5s, 10s, 30s, 60s |
| | Langsame Bewegung | 720P/120FPS, 1080P/60FPS |
| | Aufnahmeton | Ausschalten/Einschalten |
| | Bildstabilisierung | Ein/Aus (Standard: Aus) |
| Foto | Foto-Auflösung | 20M/16M/12M/8/M/5M/2M |
| | In bestimmter Zeit Fotografieren | Ausschalten, 3S, 5S, 10S, 20S |
| | Automatisches Fotografieren | Ausschalten, 3S, 10S, 15S, 20S, 30S |
| | Burst-Modus/Drama Aufnahme | Ausschalten, 3P/S , 5P/S, 10P/S |
| Einstellungen der Kamera | Weißabgleich | Auto, Sonnig, Bewölkt, Glühlicht, Fluoreszenzlicht |
| | Belichtung | 0/1/2/3/-3/-2/-1 |
| | Bildrotation | Ausschalten / Einschalten |
| | Fahrzeugmodus | Ausschalten / Einschalten |
| | WLAN | Ausschalten / Einschalten |
| | Automatische Ausschaltung | 1minute, 3minuten,5minuten, Ausschalten |
| | Automatischer Bildschirmschoner Ausschalten | 10S, 20S, 30S |
| | Zeit Wasserzeichen | Ausschalten / Einschalten |
| | Datum / Uhrzeit | Datum: Y / M / D Zeit: H, M, S Bitte drücken Sie Hoch oder Runter-Taste, und dann die OK-Taste, um die Zeit zu stellen. |
| | Sprache | 简体中文, 繁體中文, English, 日本語, Deutsch, Français, Italiano, Español, Português, Русский, 한국어 |

EINSTELLUNGEN

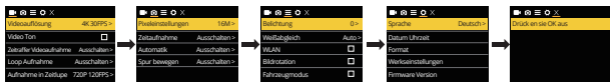

Drücken Sie die **Auslöser / Auswahl-Taste**, um das Auswahlménú zu öffnen. Drücken Sie mehrmals auf die **Ein-Aus / Modus-Taste**, um die Optionen anzuzeigen und drücken Sie die **Auslöser / Auswahl-Taste**, um die gewünschte Option zu wählen. Oder benutzen Sie die nach **Oben/Wiedergabe** oder nach **Unten/Wifi-Taste**, um die verschiedenen Optionen anzuzeigen.

VIDEO MODUS

Um ein Video aufzuzeichnen, prüfen Sie, ob die Kamera im **Video Modus** ist. Falls das Video Symbol nicht auf dem LCD Bildschirm Ihrer Kamera erscheint, drücken Sie mehrmals auf die **Ein-Aus / Modus-Taste**, bis es erscheint.

Zum Beginn der Aufzeichnung:

Drücken Sie die **Auslöser / Auswahl-Taste**. Die Kamera gibt einen Signalton ab und die **Kamera- Status-Leuchte** blinkt während der Aufzeichnung.

Zum Beenden der Aufzeichnung:

Drücken Sie die **Auslöser / Auswahl-Taste**. Die **Kamera-Status-Leuchte** blinkt nicht mehr und die Kamera gibt einen Signalton ab, um das Ende der Aufzeichnung anzuzeigen.

Diese Kamera stoppt die Aufzeichnung automatisch, wenn die Batterie leer ist. Ihr Video wird gespeichert, bevor sich die Kamera ausschaltet.

FOTO MODUS

Um ein Foto aufzunehmen, prüfen Sie, ob die Kamera im **Foto Modus** ist. Falls das Foto Symbol auf dem LCD Bildschirm nicht erscheint, drücken Sie mehrmals auf die **Ein-Aus / Auswahl-Taste**, bis es erscheint.

Ein Foto aufnehmen:

Drücken Sie die **Auslöser / Auswahl-Taste**. Die Kamera gibt einen **Kamera-Auslöser-Ton** ab.

ZEITLUPEN MODUS

Eine Serie im Zeitlupen Modus und die Kamera in Zeitlupe erfassen. Wenn der Zeitlupen Modus im LCD Bildschirm von Ihrer Kamera nicht angezeigt wird, drücken Sie den **Ein-Aus / Modus** kontinuierlich, bis er wieder schein.

Eine Serie von Zeitlupen machen:

Drücken Sie den **Auslöser / Auswahl-Taste**. Die Kamera signalisiert, dass das Video ausgelöst werden soll.

WIEDERGABE

Videos und Fotos wiedergeben

1. Prüfen Sie, ob die Kamera in Kamera-Modus ist.
2. Um zwischen Videos und Fotos zu suchen, drücken Sie wiederholt die **Abwärts-/WLAN-Taste**
3. Drücken Sie die **Auslöser / Auswahl-Taste**, um die gewünschte Option zu wählen.
4. Um die verschiedenen Optionen zu suchen, benutzen Sie die **nach Unten / Wifi-Taste**.

SPEICHER / SPEICHERKARTE

Diese Kamera ist kompatibel mit 8 GB, 16 GB und 32 GB Kapazität Speicherkarte. Sie müssen eine Speicherkarte mit einer Geschwindigkeitsklasse 10 benutzen.

Wir empfehlen den Gebrauch von Marken-Speicherkarten für eine maximale Zuverlässigkeit unter starken Vibrationsbedingungen.

Hinweis: Formatieren Sie die Speicherkarte vor der ersten Benutzung

BATTERIE

Aufladen der Batterie

1. Verbinden Sie die Kamera mit einem Computer oder einem USB-Netzgerät.
2. Die Ladestatusleuchte ist eingeschaltet, während die Batterie geladen wird.
3. Die Ladestatusleuchte schaltet aus, wenn die Batterie voll geladen ist.

* Ladedauer: 3-5 Stunden

KAMERA APP UND Wifi

Verbinden mit der „XDV“ App

Mit der „XDV“ App kontrollieren Sie Ihre Kamera aus der Ferne mithilfe eines Smartphones oder eines Tablets. Die Merkmale umfassen eine vollständige Kamerasteuerung, Live Vorschau, Foto-Wiedergabe und Teilen von ausgewähltem Inhalt und mehr.

1. Laden Sie die „XDV“ App auf Ihr Smartphone oder Tablet bei Google Play oder im Apple App.
2. Drücken Sie die Ein-Aus / Modus-Taste, um die Kamera EINZUSCHALTEN.
3. Stellen Sie sicher, dass sich Ihre Kamera im Kamera- oder Videomodus befindet.
4. Halten Sie die Taste UP 3 Sekunden lang gedrückt, um Wifi einzuschalten.
5. In Ihrem Smartphone oder Tablet Wifi-Einstellungen, verbinden Sie mit dem Netzwerk namens „ActionCam“.
6. Geben Sie das Kennwort „1234567890“ ein.
7. Öffnen Sie die SportLook App auf Ihrem Smartphone oder Tablet.

KONTAKTIEREN SIE UNS

Bei Problemen mit DragonTouch-Produkten können Sie sich gerne an uns wenden. Wir werden Ihnen innerhalb von 24 Stunden antworten.

E-Mail-Adresse: dragontouch.com

Offizielle website: www.dragontouch.com

CONTENIDO

| | |
|--------------------------------------|----|
| SU VISIÓN 3 | 34 |
| GUÍA DE INICIO | 36 |
| FUNCIONES GENERALES | 36 |
| AJUSTES | 38 |
| MODO DE VIDEO | 38 |
| MODO DE FOTO | 39 |
| MODO DE CÁMARA LENTA | 39 |
| REPRODUCCIÓN | 39 |
| ALMACENAMIENTO/TARJETA DE MEMORIA | 40 |
| BATERÍA | 40 |
| APLICACIÓN XDV PARA LA CÁMARA Y Wifi | 41 |
| CONTÁCTENOS | 41 |

SU VISIÓN 3

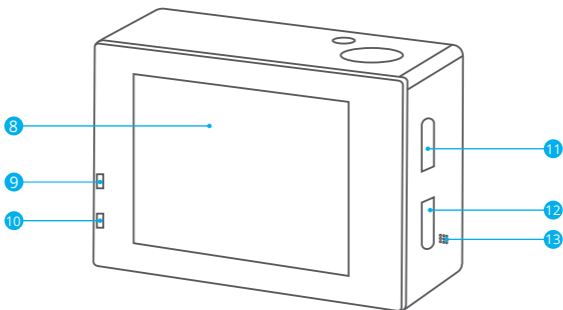
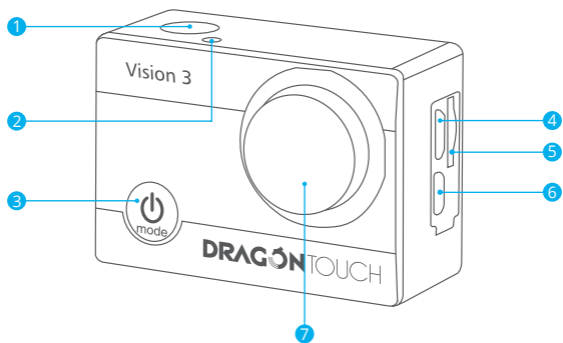

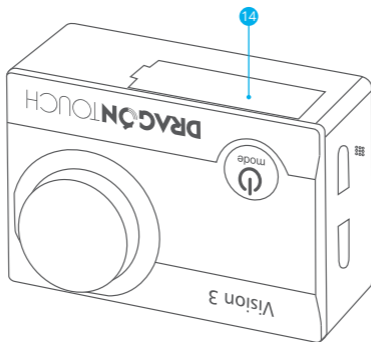

- | | |
|--------------------------------------|--------------------------------|
| 1 Obturador / Botón de Selección | 8 Pantalla |
| 2 Indicador Wifi | 9 Indicador de carga |
| 3 Botón de Encendido / Modo / Salida | 10 Indicador de funcionamiento |
| 4 Puerto Micro USB | 11 Botón Arriba |
| 5 Ranura Tarjeta de memoria | 12 Botón Abajo |
| 6 Puerto micro HDMI | 13 Altavoz |
| 7 Lente | 14 Cubierta de batería |

Nota: La cámara no grabará sonido cuando esté en el estuche impermeable.

GUÍA DE INICIO

¡SALUDOS!

¡Felicidades por la adquisición de su nueva cámara! Este Manual de usuario le ayudará a aprender los elementos básicos, ¡para captar los momentos más increíbles de la vida!

Para encenderla:

Presione el botón de Encendido/Modo.

Para apagarla:

Mantenga presionado el botón de Encendido/Modo.

FUNCIONES GENERALES

Encienda la cámara y presione el botón de Encendido/Modo varias veces, para alternar entre los diferentes modos y ajustes de la cámara.

Los modos aparecerán en el siguiente orden:

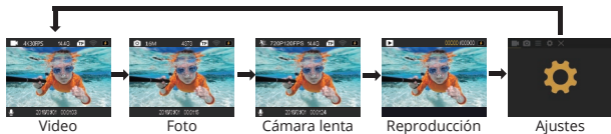

Video: grabar un video.

Foto: capturar una sola foto.

Cámara lenta: grabar movimientos para un efecto dramático.

Reproducción: reproducir un video grabado.

Ajustes: modificar los ajustes de la cámara, incluyendo cambiar la resolución de videos, el modo de videos, resolución de fotos, modo de fotos y exposición e idioma, entre otras.

| Modo | Función | Especificaciones |
|----------------------|---------------------------|---|
| Ajustes de video | Resolución de video | 1080P / 60FPS, 1080P / 30FPS, 720P / 120FPS, 720P / 60FPS, 720P / 30FPS, 2.7K / 30FPS, 4K / 30FPS |
| | Grabación en bucle | 2 minutos, 3 minutos, 5 minutos, Desactivar |
| | Lapso de tiempo | Desactivar, 0.5s, 1s, 2s, 5s, 10s, 30s, 60s |
| | Cámara lenta | 720P/120FPS, 1080P/60FPS |
| | Grabación de audio | Activar/Desactivar |
| | Estabilización de imagen | Encendido/Apagado (Predeterminado:apagado) |
| Ajustes de foto | Resolución de foto | 20M/16M/12M/8M/5M/2M |
| | Temporizador | Desactivar, 3S, 5S, 10S, 20S |
| | Toma de fotos automática | Desactivar, 3S, 10S, 15S, 20S, 30S |
| | Modo de Drama | Desactivar, 3 fotos/s, 5 fotos/s, 10 fotos/s |
| Ajustes de la cámara | Balance de blancos | Automático, Soleado, Nublado, Luz incandescente, Luz fluorescente |
| | Exposición | 0/1/2/3/-3/-2/-1 |
| | Rotación de imagen | Activar/Desactivar |
| | Modo de conducción | Activar/Desactivar |
| | Modo de Wifi | Activar/Desactivar |
| | Salvapantallas automático | 10s, 20s, 30s, Desactivar |
| | Apagado automático | 1 min, 3 min, 5 min, Desactivar |
| | Marca de tiempo | Activar/Desactivar |
| | Fecha y hora | Fecha: M/D/A Hora: H, M, S Presione el botón de Abajo y Aceptar, para modificar la fecha y hora. |
| | Idioma | 简体中文, 繁體中文, English, 日本語, Deutsch, Français, Italiano, Español, Português, Русский, 한국어 |

AJUSTES



Presione el botón de Encendido/Modo para entrar al menú de Ajustes. Presione repetidamente el botón de Encendido/Modo para alternar entre las opciones y presione el botón de Disparo/Seleccionar, para seleccionar la opción deseada. También puede usar el botón de Abajo/Wifi para navegar por las opciones.

MODO DE VIDEO

Para grabar, verifique que la cámara esté en modo de Video. Si el ícono de Video no aparece en la pantalla LCD de la cámara, presione el botón de Encendido/Modo repetidamente hasta visualizarlo.

Para comenzar a grabar:

Presione el botón de Disparo/Seleccionar. La cámara emitirá un pitido y la luz indicadora del estado de la cámara parpadeará mientras graba.

Para detener la grabación:

Presione el botón de Disparo/Seleccionar. La luz indicadora del estado de la cámara dejará de parpadear y la cámara emitirá un pitido para indicar que la grabación se ha detenido.

Cuando la batería se agote, la cámara dejará de grabar automáticamente. El video se guardará antes de que la cámara se apague completamente.

MODO DE FOTO

Para tomar una foto, verifique que la cámara esté en modo de Foto. Si el icono de Foto no aparece en la pantalla LCD de la cámara, presione el botón de Encendido/Modo repetidamente hasta visualizarlo.

Para tomar una foto:

Presione el botón de Disparo/Seleccionar. La cámara emitirá un sonido de disparo.

MODO DE CÁMARA LENTA

Para grabar en cámara lenta, verifique que la cámara esté en modo de Cámara lenta. Si el ícono de Cámara lenta no aparece en la pantalla LCD de la cámara, presione el botón de Encendido/Modo repetidamente hasta visualizarlo.

Para grabar en Cámara lenta:

Presione el botón de Disparo/Seleccionar. La cámara emitirá un sonido de disparo.

REPRODUCCIÓN

Para acceder al menú de Reproducción:

1. Verifique que la cámara esté en modo de Reproducción.
2. Para navegar entre Videos y Fotos, presione el botón de Abajo/Wifi repetidamente.
3. Para seleccionar la opción deseada, presione el botón de Disparo/Seleccionar.
4. Para navegar entre las varias opciones, utilice el botón de Abajo/Wifi.

ALMACENAMIENTO/TARJETA DE MEMORIA

Esta cámara es compatible con tarjetas de memoria de 8GB, 16GB, 32GB y 64GB. Debe usar una tarjeta con velocidad de lectura Clase 10. Es recomendable usar tarjetas de memoria de marcas certificadas para obtener la máxima fiabilidad en actividades de mucha vibración.

Nota: antes de usar la tarjeta de memoria por primera vez, asegúrese de formatearla.

BATERÍA

Carga de la batería:

1. Conecte la cámara a un puerto USB o a una computadora.
2. La luz indicadora de carga permanecerá encendida mientras la batería se esté cargando.
3. La luz indicadora de carga se apagará cuando la batería esté completamente cargada.

*Tiempo de carga: 2.3 horas

APLICACIÓN XDV PARA LA CÁMARA Y Wifi

Conectarse a la aplicación XDV

La aplicación XDV le permite controlar la cámara de forma remota utilizando un teléfono inteligente o una tableta. La aplicación le proporciona un control total de la cámara, incluyendo la previsualización en vivo, reproducción de fotos, compartir los contenidos que desee y más.

1. Descargue la aplicación "XDV" en su teléfono inteligente o tableta, desde Google Play o App Store.
2. Encienda la cámara presionando el botón de Encendido/Modo.
3. Asegúrese de que la cámara esté en modo de Video o Foto.
4. Encienda Wifi presionando el botón de Arriba durante 3 segundos.
5. En los ajustes de Wifi de su teléfono inteligente o tableta, conéctese a la red llamada "ActionCam".
6. Introduzca la contraseña "1234567890".
7. Abra la aplicación "XDV" en su teléfono inteligente o tableta.

CONTÁCTENOS

Para cualquier consulta sobre los productos DragonTouch, por favor no dude en contactarnos, le responderemos dentro de 24 horas.

Dirección de correo electrónico: cs@dragontouch.com

Sitio web oficial: www.dragontouch.com

SOMMAIRE

| | |
|---|----|
| VOTRE VISION 3 | 43 |
| LANCEMENT | 45 |
| PRÉSENTATION | 45 |
| PARAMÈTRES | 47 |
| MODE VIDÉO | 47 |
| MODE PHOTO | 48 |
| MODE RALENTI | 48 |
| LECTURE | 48 |
| STOCKAGE/CARTE MÉMOIRE | 49 |
| BATTERIE | 49 |
| Wifi ET APPLICATION DE L'APPAREIL PHOTO | 50 |
| CONTACTEZ-NOUS | 50 |

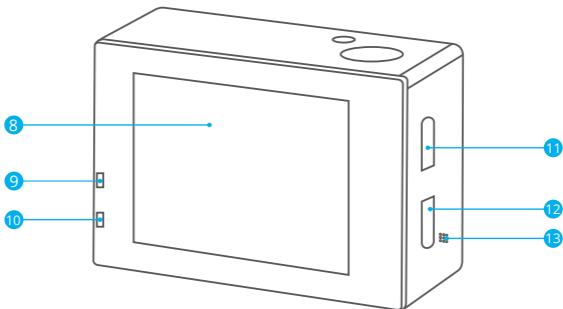
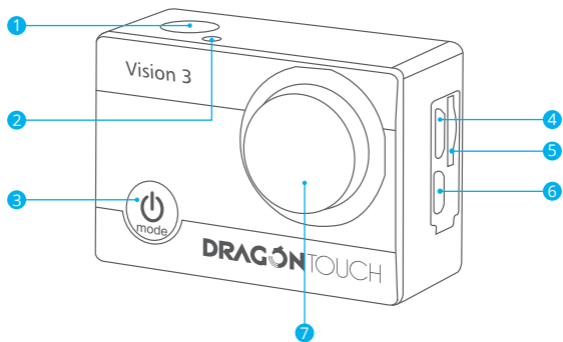

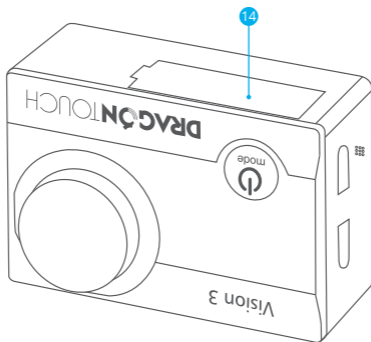

- | | |
|--|-----------------------------|
| 1 Bouton d'obturation/sélection | 8 Écran |
| 2 Indicateur Wifi | 9 Indicateur de charge |
| 3 Bouton d'alimentation / mode / sortie | 10 Indicateur de travail |
| 4 Micro USB Port | 11 Bouton haut |
| 5 Ouverture Carte Mémoire | 12 Bouton bas |
| 6 Port micro HDMI | 13 Haut-parleur |
| 7 Lentille | 14 Couvercle de la batterie |

Remarque: La caméra n'enregistre pas le son quand elle est dans le boîtier étanche.

LANCEMENT

Bonjour

Félicitations pour votre nouvelle caméra ! Ce manuel utilisateur vous aidera à apprendre les bases afin de capturer les meilleurs moments de votre vie !

Pour L'ALLUMER :

Appuyez sur le bouton d'Alimentation / Mode.

Pour L'ÉTEINDRE:

Appuyez et maintenez une pression sur le bouton d'Alimentation / Mode.

PRÉSENTATION

Allumez la caméra et appuyez plusieurs fois sur le bouton d'Alimentation / Mode pour naviguer parmi les différents modes et paramètres de la caméra.

Les modes vont apparaître dans l'ordre suivant :



Vidéo : enregistre des vidéos.

Photo : prend une seule photo.

Ralenti : Capture l'action pour un effet dramatique.

Lecture : pour visionner vos vidéos en mode rapide.

Paramètres: faites les réglages de la caméra relatifs à la résolution vidéo, au mode vidéo, à la résolution photo, au mode photo, à l'exposition, à la langue et bien d'autres choses.

| Section | Fonction | Caractéristiques |
|-----------------------------|----------------------------------|---|
| Vidéo | Résolution vidéo | 1080P / 60FPS, 1080P / 30FPS, 720P / 120FPS, 720P / 60FPS, 720P / 30FPS, 2.7K / 30FPS, 4K / 30FPS |
| | Enregistrement en boucle | 2 minutes, 3 minutes, 5 minutes, Arrêt |
| | Intervalle d'enregistrement | Arrêt, 0s, 5s, 1s, 2s, 5s, 10s, 30s, 60s |
| | Ralenti | 720P / 120FPS, 1080P / 60FPS |
| | Enregistrement du son | Arrêt / Marche |
| | Stabilisation d'image | Activé/Désactivé (Par défaut : Désactivé) |
| Photo | Résolution de la photo | 20M/16M/12M/8M/5M/2M |
| | Retardateur de photo | Désactivé, 3S, 5S, 10S, 20S |
| | Photo automatique | Désactivé, 3S, 10S, 15S, 20S, 30S |
| | Mode rafale/ prise dramatique | Désactivé, 3P/S, 5P/S, 10P/S |
| Réglages de la caméra | Balance des blancs | Automatique, ensoleillé, nuageux, lumière incandescente, lumière fluorescente |
| | Exposition | 0/1/2/3/-3/-2/-1 |
| | Rotation de l'image | Arrêt / Marche |
| | Mode conduite | Arrêt / Marche |
| | Mode Wifi | Arrêt / Marche |
| | Écran de veille auto | 10s, 20s, 30s, Arrêt |
| | Extinction auto | 1 minute, 3minutes, 5minutes, Arrêt |
| | Horodatage | Arrêt / Marche |
| | Date et heure | Date : M/J/A Heure: H, M, S Appuyez sur le bouton Bas et OK pour sélectionner la date et l'heure |
| | Langue | 简体中文, 繁體中文, English, 日本語, Deutsch, Français, Italiano, Español, Português, Русский, 한국어 |

PARAMÈTRES



Appuyez sur le bouton d’Alimentation / Mode pour accéder au menu des paramètres. Appuyez sur le Bouton d’Alimentation / Mode de façon répétée pour naviguer entre les options et appuyez sur le bouton Prise / Sélection pour sélectionner l’option voulue. Ou bien utilisez le bouton Bas / Wifi pour naviguer parmi les options.

MODE VIDÉO

Pour enregistrer des vidéos, vérifiez que la caméra est en Mode Vidéo. Si sur l’écran LCD de votre appareil photo l’icône Vidéo n’apparaît pas, appuyez sur le bouton Alimentation / Mode de façon répétée, jusqu’à ce qu’il apparaisse.

Pour commencer un enregistrement :

Appuyez sur le bouton Prise/ Sélection. La caméra émettra un bip et les voyants de statut de l’appareil clignoteront pendant l’enregistrement.

Pour terminer un enregistrement :

Appuyez sur le bouton Prise / Sélection. Les voyants de statut de l’appareil cesseront de clignoter et la caméra va alors émettre un bip pour indiquer que l’enregistrement est terminé. La caméra cesse automatiquement l’enregistrement lorsque la batterie est déchargée.

Votre vidéo sera sauvegardée avant que l’appareil ne s’éteigne.

MODE PHOTO

Pour prendre une photo, vérifiez que la caméra est bien sur le Mode Photo. Si l'icône Photo n'apparaît pas sur l'écran LCD de votre appareil, pressez le bouton d'Alimentation / Mode de façon répétée jusqu'à ce qu'il apparaisse.

Pour prendre une photo :

Appuyez sur le bouton Prise / Sélection. La caméra émettra le son d'un obturateur photo.

MODE RALENTI

Pour prendre une série au ralenti, vérifiez que la caméra est en Mode Ralenti. Si l'icône ralenti n'apparaît pas sur l'écran LCD de votre appareil, pressez le bouton d'Alimentation/ Mode de façon répétée jusqu'à ce qu'il apparaisse.

Pour prendre une série en ralenti :

Appuyez sur le bouton Prise / Sélection. La caméra émettra le bruit d'une prise de vidéo.

LECTURE

Pour accéder au menu Lecture:

1. Vérifiez que l'appareil photo est en **Mode Lecture**.
2. Pressez le **bouton Bas / Wifi** de façon répétée pour naviguer parmi les Vidéos et les Photos.
3. Pressez le **bouton Prise / Sélection** pour sélectionner l'option voulue.
4. Utilisez le **bouton Bas / Wifi** pour naviguer parmi les options.

STOCKAGE/ CARTE MÉMOIRE

Cet appareil est compatible avec des cartes mémoire de capacité 8GB, 16GB, 32GB et 64GB. Vous devez utiliser une carte mémoire avec une vitesse de classe 10. Nous recommandons l'utilisation de cartes mémoire de marque pour une meilleure résistance face aux activités qui engendrent des secousses violentes.

Remarque : Formatez la carte mémoire avant la première utilisation.

BATTERIE

Rechargement de la batterie :

1. Connectez la caméra à un ordinateur ou une source d'alimentation par le câble USB.
2. Le voyant de statut en recharge reste allumé lorsque la batterie est en charge.
3. Le voyant de statut en recharge s'éteint lorsque la batterie n'est pas chargée.

*Temps de chargement : environ 2 à 3 heures

Wifi ET APPLICATION DE L'APPAREIL PHOTO

Se connecter à l'application XDV

L'application "XDV" vous permet de contrôler votre caméra à distance par l'entremise d'un smartphone ou d'une tablette. Les fonctionnalités de l'application comprennent un contrôle complet de l'appareil, une prévisualisation en direct, la lecture des photos, le partage du contenu sélectionné et plus encore.

1. Téléchargez l'application "XDV" sur votre téléphone ou tablette depuis Google Play ou l'App Store.
2. Appuyez sur le bouton d'**Alimentation / Mode** pour allumer l'appareil.
3. Assurez-vous que votre appareil est en mode Appareil Photo ou caméra Vidéo.
4. Appuyez sur le bouton "**Haut**" pendant 3 secondes pour allumer le Wifi.
5. Dans les paramètres de votre téléphone ou de votre tablette, connectez-vous au réseau « ActionCam ».
6. Entrez le mot de passe "1234567890".
7. Ouvrez l'application "XDV" sur votre smartphone ou votre tablette.

CONTACTEZ-NOUS

Pour tout problème avec les produits DragonTouch, n'hésitez pas à nous contacter, nous vous répondrons dans les 24 heures.

Adresse E-mail: cs@dragontouch.com

Site web officiel: www.dragontouch.com

CONTENUTI

| | |
|--------------------------|----|
| LA VOSTRA VISIONE 3 | 52 |
| COME INIZIARE | 54 |
| PANORAMICA | 54 |
| IMPOSTAZIONI | 56 |
| MODALITÀ VIDEO | 56 |
| MODALITÀ FOTO | 57 |
| MODALITÀ SLOW MOTION | 57 |
| RIPRODUZIONE | 57 |
| MEMORIA / SCHEDA MEMORIA | 58 |
| BATTERIA | 58 |
| APP TELECAMERA & Wifi | 59 |
| CONTATTI | 59 |

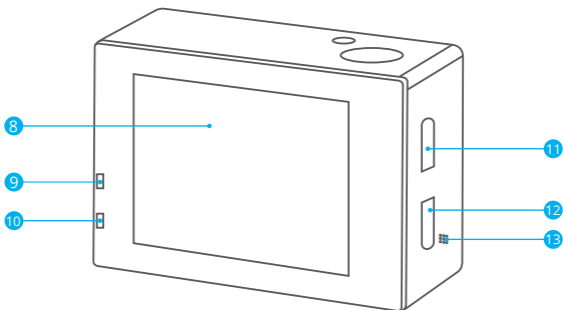
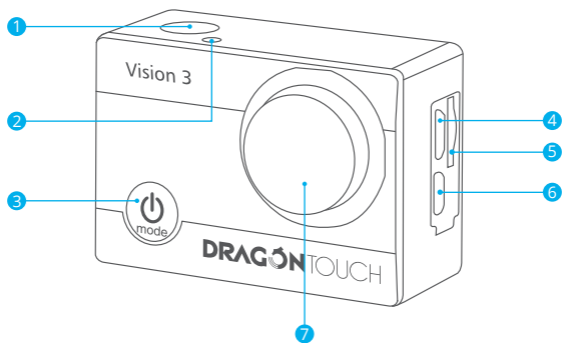

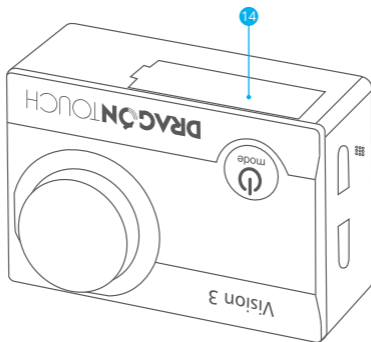

- | | |
|---|-----------------------------------|
| 1 Pulsante di scatto / selezione | 8 Schermo |
| 2 Indicatore Wifi | 9 Indicatore di carica |
| 3 Pulsante di accensione / modalità / uscita | 10 Indicatore di funzionamento |
| 4 Porta micro USB | 11 Pulsante Su |
| 5 Slot per Scheda Memoria | 12 Pulsante Giù |
| 6 Porta per micro HDMI | 13 Altoparlante |
| 7 Lenti | 14 Coperchio della batteria |

Nota: La camera non registrerà il suono quando si trova nella custodia impermeabile.

COME INIZIARE

BENVENUTO

Congratulazioni per la tua nuova fotocamera! Il manuale di istruzioni ti aiuterà nell'imparare a catturare i momenti più incredibili della vita!

Accensione:

Premere il Tasto di accensione / Modalità.

Spegnimento:

Premere il Tasto di accensione / Modalità

PANORAMICA

Accendere la telecamera e mantenere premuto il **Tasto di accensione / Modalità** per muoversi tra le modalità e le impostazioni della telecamera.

Le modalità appariranno nel seguente ordine:



Video: Registra Video.

Foto: Scatta una singola foto.

Rallentatore: Cattura un'azione con effetto cinematografico.

Riproduzione: Guarda il video in modalità veloce.

Impostazioni: Regola le impostazioni della telecamera per la risoluzione e la modalità dei video, la risoluzione e la modalità delle foto, l'esposizione, la lingua e altro ancora.

| Sezione | Funzione | Specifiche |
|-------------------------------|------------------------------|---|
| Video | Risoluzione Video | 1080P / 60FPS, 1080P / 30FPS, 720P / 120FPS, 720P / 60FPS, 720P / 30FPS, 2.7K / 30FPS, 4K / 30FPS |
| | Registrazione in loop | 2 minuti, 3 minuti, 5 minuti, spenta |
| | Timelapse | Spenta, 0.5s , 1s, 2s , 5s, 10s, 30s, 60s |
| | Rallentatore | 720P / 120FPS, 1080P / 60FPS |
| | Registrazione Suono | Spenta / Accesa |
| | Stabilizzazione immagine | On/Off (Predefinito: Off) |
| Photo | Risoluzione foto | 20M / 16M / 12M / 8M / 5M / 2M |
| | Fotografia temporizzata | Spenta, 3S, 5S, 10S, 20S |
| | Autoscatto | Spenta, 3S, 10S, 15S, 20S, 30S |
| | Scatto in modalità a raffica | Spenta, 3P/S , 5P/S, 10P/S |
| Impostazioni della fotocamera | Bilanciamento del bianco | Auto, Soleggiato, Nuvoloso, Luce incandescente, luce fluorescente |
| | Esposizione | 0/1/2/3/-3/-2/-1 |
| | Rotazione Immagine | Spenta / Accesa |
| | Modalità guida | Spenta / Accesa |
| | Modalità Wifi | Spenta / Accesa |
| | Screensaver automatico | 10s, 20s, 30s, spento |
| | Auto-spegnimento | 1 minuto, 3 minuti, 5 minuti, spento |
| | Filigrana della data | Spenta / Accesa |
| | Data / Ora | Data: M/G/A Ora: O, M, S Premere tasto Giù e OK per la selezione di data e ora |
| | Lingua | 简体中文, 繁體中文, English, 日本語, Deutsch, Français, Italiano, Español, Português, Русский, 한국어 |

IMPOSTAZIONI



Premere il Tasto di accensione / Modalità per accedere al menù impostazioni. Premere ripetutamente il Tasto di accensione / Modalità per muoversi tra le opzioni e il Tasto di Scatto/ Selezione per selezionare l'opzione desiderata. In alternativa, usare il Tasto Giù / Wifi per muoversi tramite le diverse opzioni.

MODALITÀ VIDEO

Per girare un Video, verificare che la telecamera sia in Modalità Video. Se l'icona del Video non è presente sullo schermo LCD della telecamera, premere il Tasto di accensione / Modalità ripetutamente fino a che non compare.

Per iniziare a girare:

Premere il Tasto di scatto / Selezione. La telecamera emetterà un beep e la luce di stato della telecamera lampeggerà durante la registrazione.

Per smettere di girare:

Premere il Tasto di scatto / Selezione. La spia di stato della telecamera smetterà di lampeggiare ed emetterà un beep per avisare che la registrazione è stata fermata. La telecamera smette automaticamente di registrare quando la batteria è scarica. Il Video sarà salvato prima che la telecamera si spenga.

MODALITÀ FOTO

Per scattare una Foto, verificare che la telecamera sia in **Modalità Foto**. Se l'icona della Foto non è presente sullo schermo LCD della telecamera, premere il **Tasto di accensione / Modalità** ripetutamente fino a che non compare.

Per scattare una foto:

Premere il **Pulsante di scatto / Selezione**. La telecamera emetterà il suono di scatto

MODALITÀ SLOW MOTION

Per scattare una serie di foto a Rallentatore, verificare che la telecamera sia in **Modalità Rallentatore**. Se l'icona della Rallentatore non è presente sullo schermo LCD della telecamera, premere il **Tasto di accensione / Modalità** ripetutamente fino a che non compare.

Per scattare una serie di foto a Rallentatore:

Premere il **Pulsante di scatto / Selezione**. La telecamera emetterà il suono di scatto.

RIPRODUZIONE

Per accedere al menù di RIPRODUZIONE:

1. Verificare che la telecamera sia in modalità **Riproduzione**.
2. Ripetutamente premere il **Tasto Giù / Wifi** per muoversi tra Video e Foto.
3. Premere il **Pulsante di scatto / Selezione** per selezionare l'opzione desiderata
4. Usare il **Tasto Giù / Wifi** per muoversi tra le diverse opzioni.

MEMORIA / SCHEDA MEMORIA

La telecamera è compatibile con scheda memoria da 8GB, 16GB, 32GB e 64GB. Usare una scheda memoria con velocità Classe 10. Raccomandiamo di usare card di marchi conosciuti per la massima affidabilità in attività ad alta vibrazione.

Nota: Formattare la scheda memoria prima di usarla la prima volta.

BATTERIA

Caricare la Batteria:

1. Connettere la telecamera a un computer o a un caricatore USB.
2. La luce di carica rimane accesa fino a quando la batteria è in carica.
3. La luce di carica si spegne quando la batteria è carica.

*Tempo di carica: 2 / 3 ore.

APP TELECAMERA & Wifi

Connettere all'App XDV

L'App "XDV" permette di controllare la telecamera da remoto con smartphone o tablet. Le funzionalità dell'APP includono il pieno controllo della telecamera, anteprima live, riproduzione foto, condivisione dei contenuti e altro ancora.

1. Scaricare l'App "XDV" sullo smartphone o sul tablet dal Google Play o Apple App Store.
2. Premere il **Tasto di accensione / Modalità** per accendere la telecamera.
3. Assicurarsi che la telecamera sia in modalità fotocamera, non modalità Video.
4. Premere il Tasto Su per 3 secondi per accendere il Wifi.
5. Nelle impostazioni WiFi del tuo smartphone o tablet, connettere alla rete "ActionCam".
6. Immettere la password "1234567890".
7. Awiare l'App "XDV" sullo smartphone o sul tablet.

CONTATTI

Per qualsiasi problema con i prodotti di DragonTouch, non esitate a contattarci, risponderemo entro 24 ore.

Indirizzo email: cs@dragontouch.com

Sito ufficiale: www.dragontouch.com

目次

| | |
|--------------|----|
| あなたのVISION 3 | 61 |
| はじめに | 63 |
| 概要 | 63 |
| 設定 | 65 |
| ビデオモード | 65 |
| 写真モード | 66 |
| スローモーションモード | 66 |
| 再生 | 66 |
| ストレージ | 67 |
| バッテリー | 67 |
| カメラアプリ | 68 |
| お問い合わせ | 68 |

あなたのVISION 3

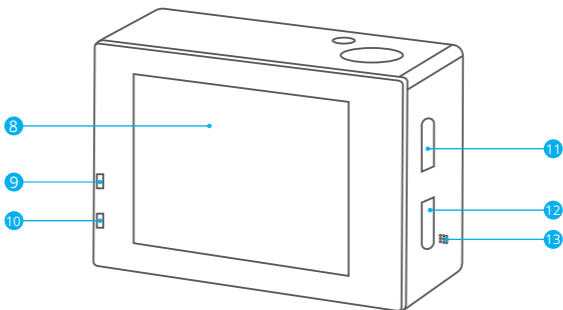
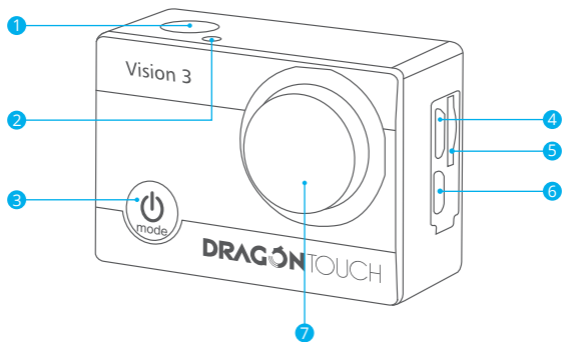

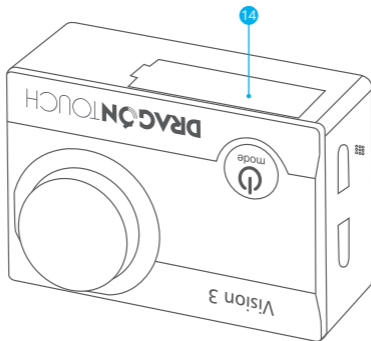

- | | |
|--------------------|------------|
| ① シャッター / 選択ボタン | ⑧ 液晶画面 |
| ② Wifi ランプ | ⑨ 充電ランプ |
| ③ 電源 / モード / 終了ボタン | ⑩ 作動ランプ |
| ④ マイクロUSBポート | ⑪ アップボタン |
| ⑤ メモリカードスロット | ⑫ ダウンボタン |
| ⑥ マイクロHDMIポート | ⑬ スピーカー |
| ⑦ レンズ | ⑭ バッテリーカバー |

注意: 防水ケースに入っている時には音声は録音されません。

はじめに

こんにちは。

新しいカメラをお買い上げいただき、ありがとうございます。このユーザーマニュアルでは人生の最も素晴らしい瞬間を保存する基本的な方法を説明いたします。

電源を入れる：

電源 / モードボタンを押します。

電源を切る：

電源 / モードボタンを長押しします。

概要

カメラの電源を入れ、連続して電源 / モードボタンを押すと、カメラモードと設定が切り替わります。モードは次の順に表示されます。

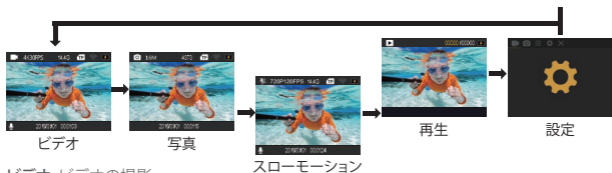

ビデオ: ビデオの撮影

写真: 単一写真の撮影

スローモーション: 劇的な効果を得るためのキャプチャ。

再生: クイックモードで動画を表示する。

設定: ビデオ解像度、ビデオモード、写真解像度、写真モード、露出、言語などのカメラ設定を調整する。

| セクション | 機能 | 仕様 |
|--------|-----------------|---|
| ビデオ | ビデオ解像度 | 1080P / 60FPS、1080P / 30FPS、720P / 120FPS、720P / 60FPS、720P / 30FPS、2.7K / 30FPS、4K / 30FPS |
| | ループ録音 | 2分間、3分間、5分間、オフ |
| | 時間の経過 | オフ、0.5s、1s、2s、5s、10s、30s、60s |
| | スローモーション | 720P / 120FPS 1080P / 60FPS |
| | 録音 | オン / オフ |
| | 手ぶれ補正 | オン/オフ(デフォルト設定:オフ) |
| 写真 | 写真の解像度 | 20M/16M/12M/8M/5M/2M |
| | タイミングのとれた写真 | オフ、3s、5s、10s、20s |
| | オート写真 | オフ、3s、10s、15s、20s、30s |
| | バーストモード/ドラマショット | オフ、3P/s、5P/s、10P/s |
| カメラの設定 | ホワイトバランス | 自動、晴れ、曇り、白熱灯、蛍光灯 |
| | 暴露 | 0/1/2/3/-3/-2/-1 |
| | 画像回転 | オン / オフ |
| | 運転モード | オン / オフ |
| | Wifi モード | オン / オフ |
| | オートパワーオフ | 1分、3分、5分、オフ |
| | オートシャットダウン | 1分、3分、5分、オフ |
| | 時間透かし | オン / オフ |
| | 日付時刻 | 日付: Y / M / D 時刻: H、M、S付の下に、OKボタンを押します。時間選択 |
| | 言語 | 簡体中文、繁体中文、English、日本語、Deutsch、Français、Italiano、Español、Português、P у с с к и й、한국어 |

設定

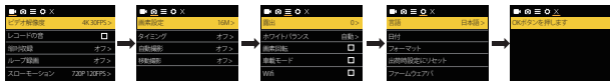

電源 / モードボタンを押すと、設定メニューに入ります。

電源 / モードボタンを繰り返し押してオプションを切り替え、シャッター / 選択ボタンを押して希望のオプションを選択します。

または、下/Wifiボタンを押し、さまざまなオプションを切り替えることができます。

ビデオモード

ビデオを撮影するにはカメラがビデオモードになっていることを確認してください。ビデオアイコンがカメラのLCD画面に表示されていない場合は、表示されるまで電源 / モードボタンを押してください。

撮影を開始するには：

シャッター / 選択ボタンを押します。カメラがピープ音を1回鳴らし、撮影中はカメラのステータスライトが点灯します。

撮影を停止するには：

シャッター / 選択ボタンを押します。カメラのステータスライトが消え、ピープ音を1回鳴らし、撮影が停止されたことを通知します。

このカメラは電池切れになると自動的に撮影を停止します。ビデオはカメラの電源が切れる前に保存されます。

写真モード

写真を撮影するにはカメラが写真モードになっていることを確認してください。写真アイコンがカメラのLCD画面に表示されていない場合は、表示されるまで電源/モードボタンを押してください。

写真を撮影するには:

シャッター/選択ボタンを押します。カメラからシャッター音が聞こえます。

スローモーションモード

スローモーションシリーズを撮影するには、カメラがスローモーションモードになっていることを確認してください。カメラのLCD画面にスローモーションアイコンが表示されていない場合は、表示されるまで電源/モードボタンを押してください。

スローモーションシリーズを撮影するには:

シャッター/選択OKボタンを押します。カメラはビデオをシャッターで放します。

再生

ビデオや写真の再生

1. カメラが再生モードになっているのを確認します。
2. 下/Wifiボタンを繰り返し押して、ビデオと写真を繰り返します。
3. シャッター/選択OKボタンを押して、希望するオプションを選択します。
4. 下/Wifiボタンを押して、さまざまなオプションを繰り返し表示します。

ストレージ

このカメラは8GBから32GBまでのメモ리카ードに対応しています。
スピードクラスCLASS 10以上の正規品メモ리카ード、読み込み速度80M/S以上のものを推奨いたします。

ご注意:使用する前に、最初にこのカメラでメモ리카ードをフォーマットしてください。

バッテリー

バッテリーの交換:

1. カメラをコンピューターまたは USB 電源に接続します。
2. バッテリーの充電中は充電ステータスライトが点灯します。
3. バッテリーの充電が完了すると充電ステータスライトが消えます。

* 充電時間: 3-5時間

カメラアプリ

「XDV」アプリとの接続

「XDV」アプリでスマートフォンやタブレットを使ってカメラを遠隔操作できます。

すべてのカメラ操作やライブプレビュー、写真再生、対象内容の共有、その他の機能が含まれます。

1. Google Play または Apple App Store からスマートフォンやタブレットに「XDV」アプリをダウンロードします。
2. 電源 / モードボタンを押して、カメラの電源を入れます。
3. カメラがカメラモードになっていることを確認します。
4. カメラの電源を入れ、上ボタンを長（3 秒間）押ししてWIFIをオンにします。
5. スマートフォンやタブレットの Wifi 設定で「ActionCam」とシリアル番号のネットワークに接続します。
6. パスワードには「1234567890」を入力します。
7. 「XDV」アプリをスマートフォンやタブレットで開きます。

お問い合わせ

弊社の製品についてご質問、ご意見がございましたら、下記のメールアドレスまでお問い合わせください。全力を尽くして、対応いたします。

AE-メール: cs@dragontouch.com

公式サイト: www.dragontouch.com