

# INSTRUCTION

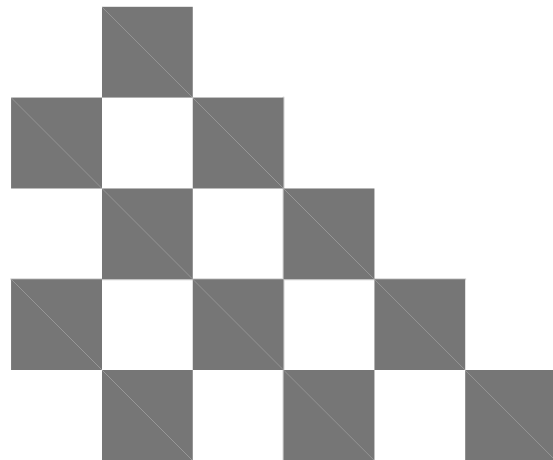

Modern Freestanding Bathtub

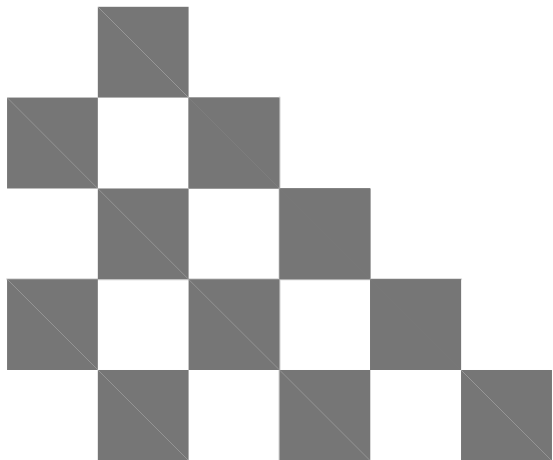



Please read Instruction carefully before installation.

## IMPORTANT

**This instruction is universal for all modern free standing bathtubs, aiming to show how to adjust the feet properly, here take one bath as an example.**

Please check the bathtub for transport damage and completeness before installation. Complaints made following installation cannot be accepted.

Please read carefully the following instructions before installing your bathtub to ensure safe and proper use and avoid any injury to either the installer or user. Failure to comply may invalidate your guarantee.

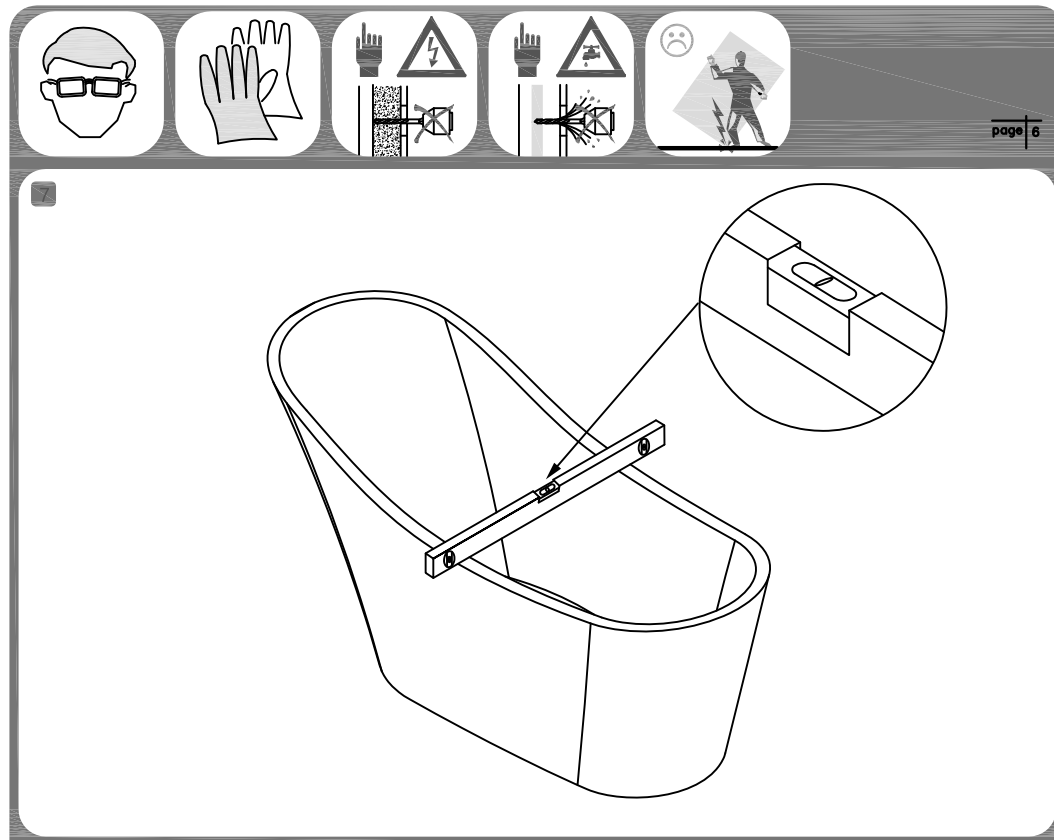
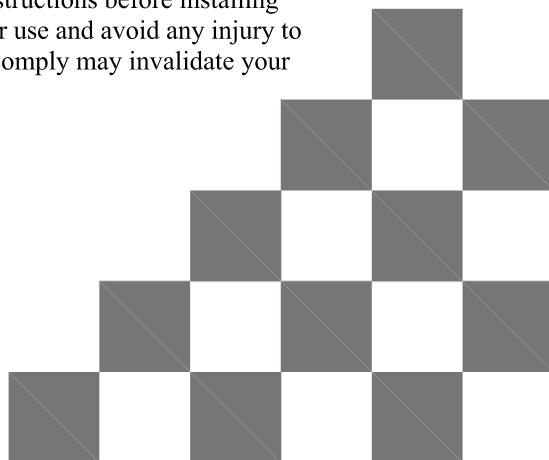

## NOTICE AND MAINTENANCE INSTRUCTION

- **Clean the bathtub periodically and dry after use**
- **Use warm soapy water and soft cloth to clean bathtub**
- **Never use alkaline cleaner**
- **Avoid harsh abrasives or dyes that will scratch or stain the surface of the bathtub**
- **Never leave metal in the bathtub, or else the bathtub would get rusty or dirty**

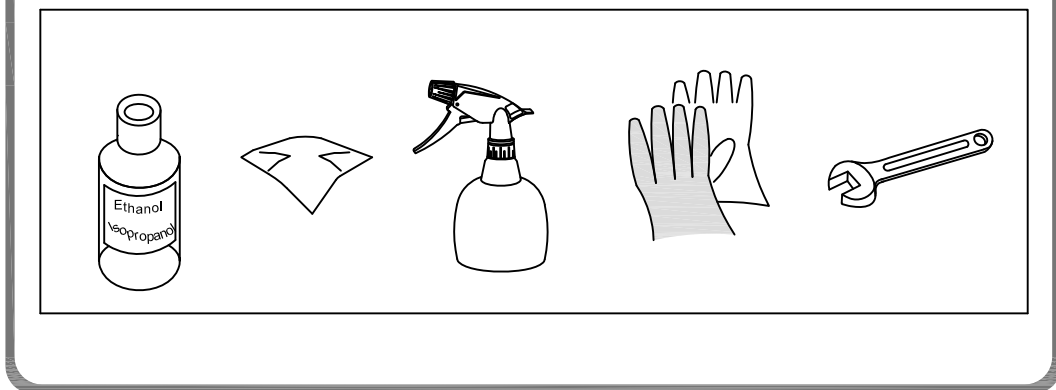
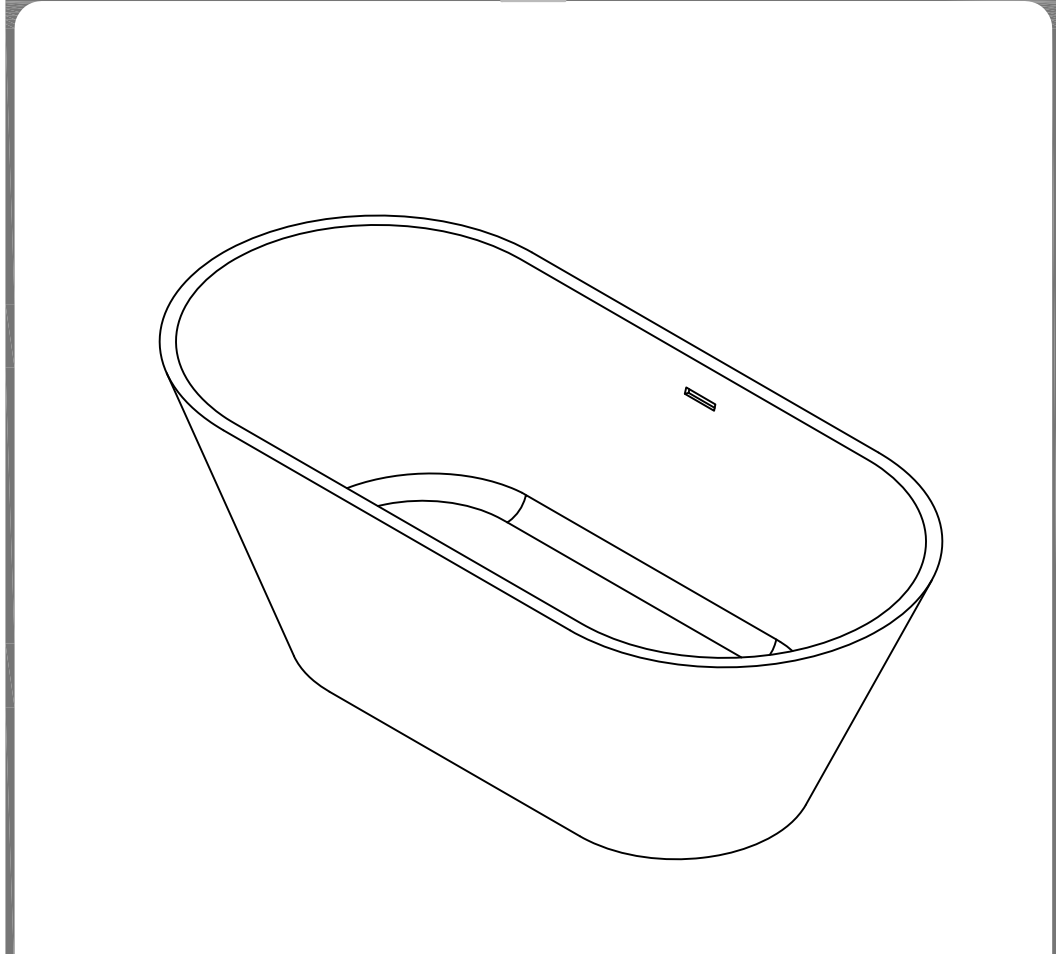
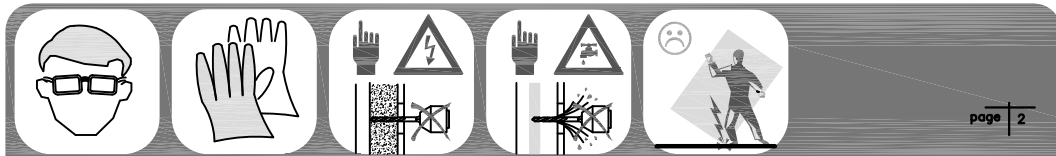
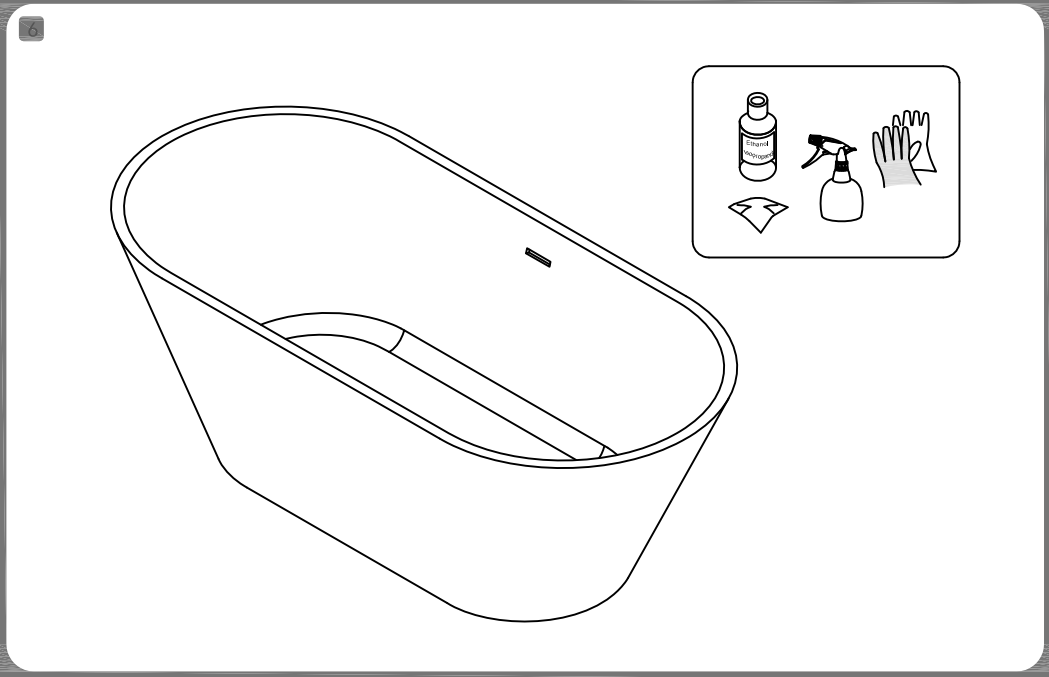
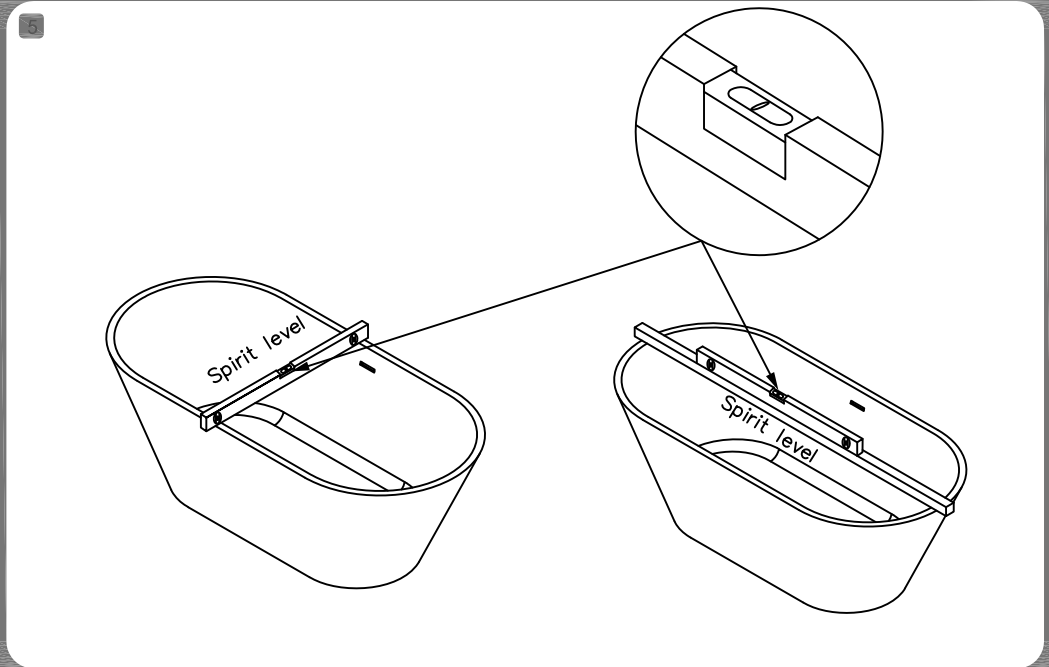
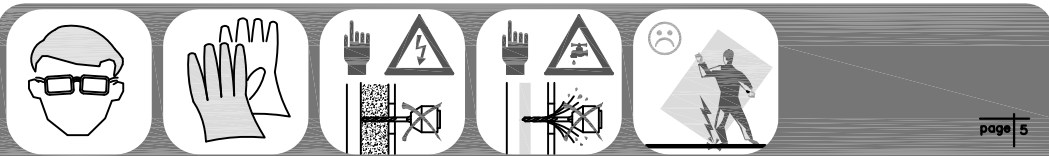

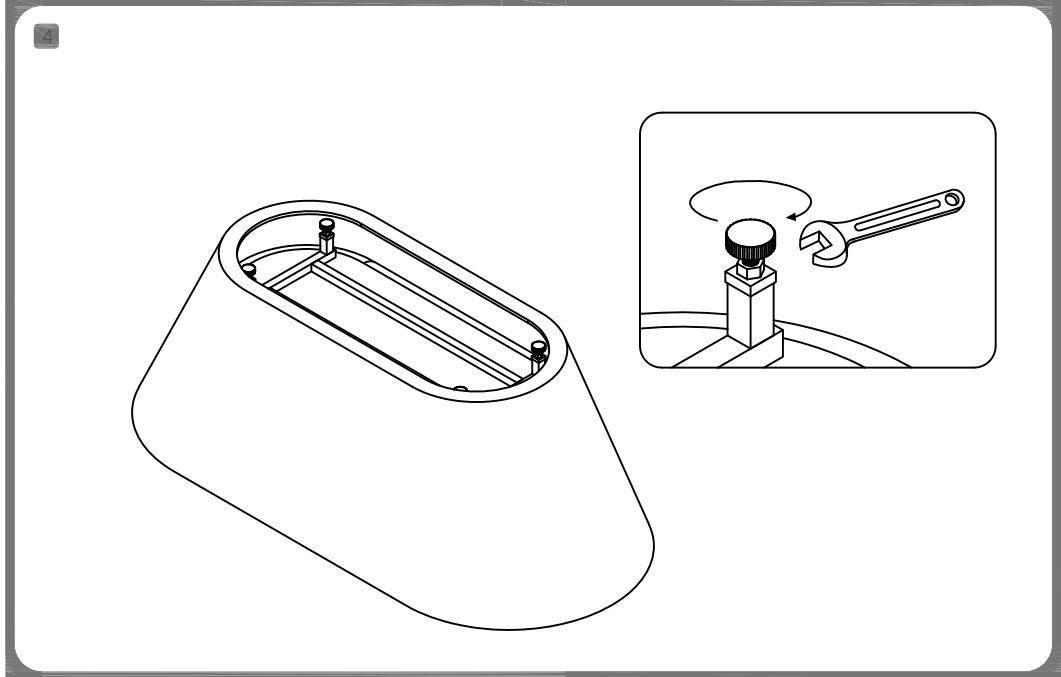
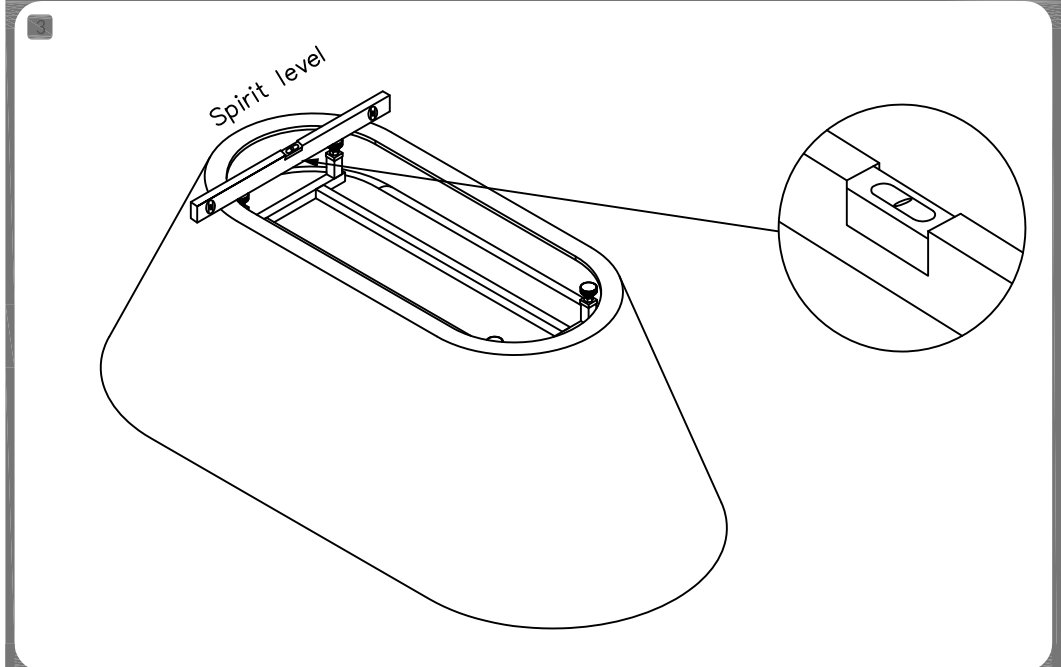
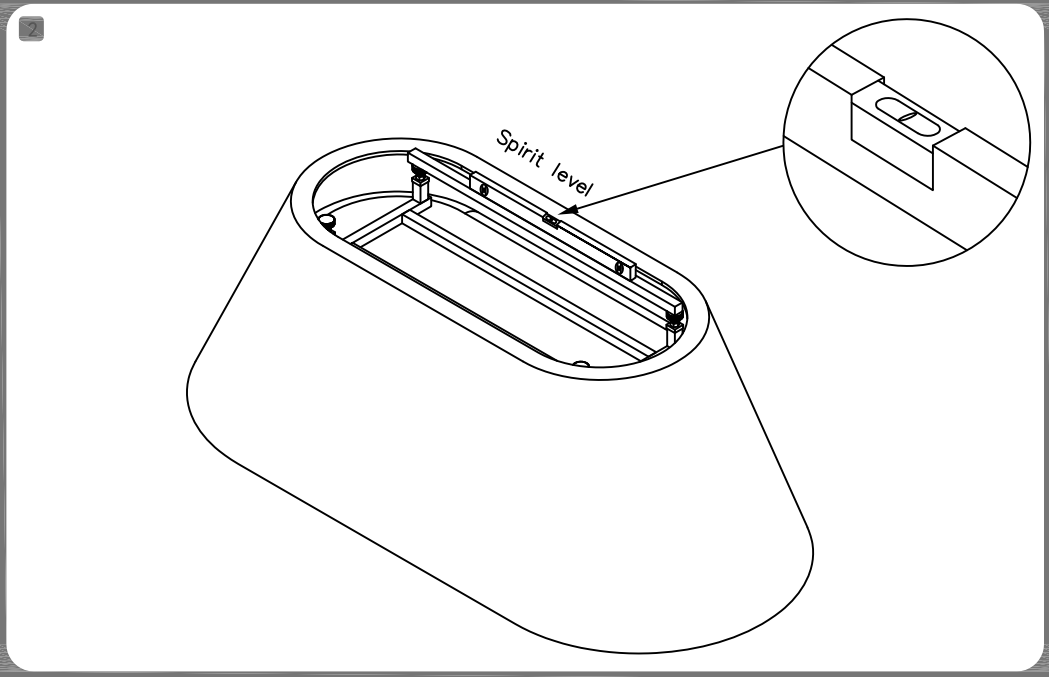
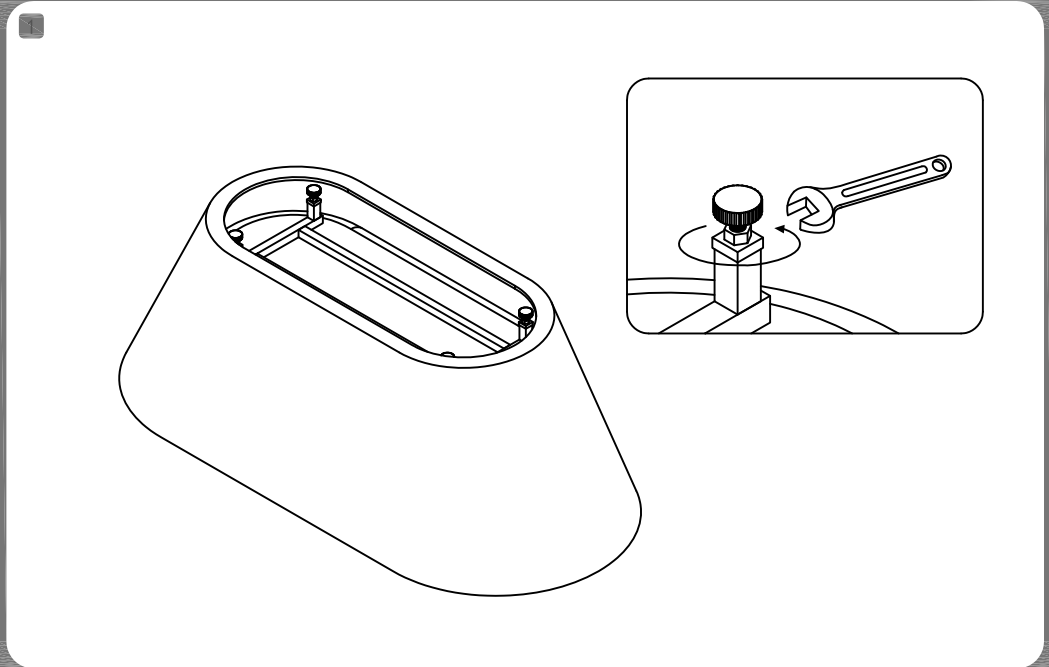

# Florence Mixer Installation

1

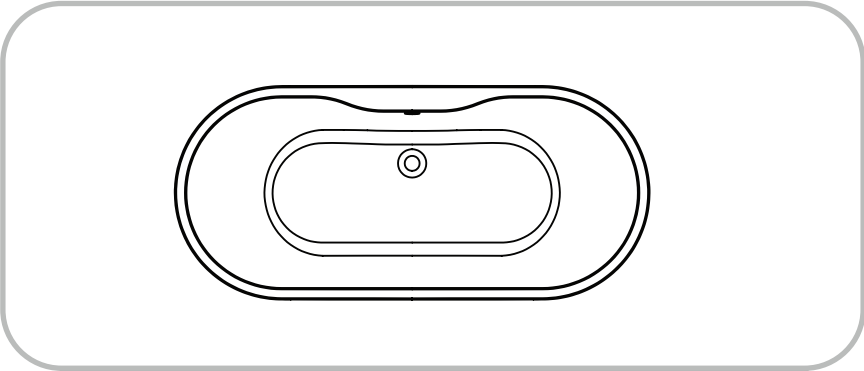

2

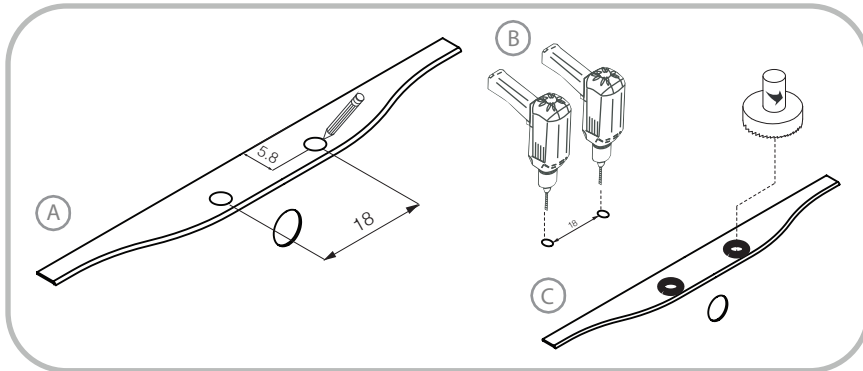

3

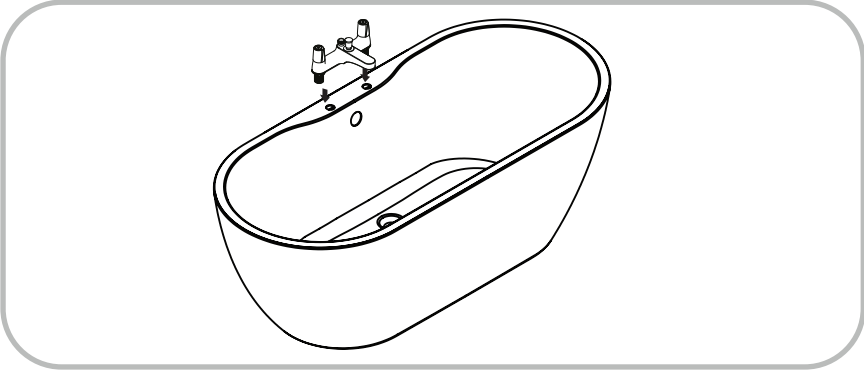

4

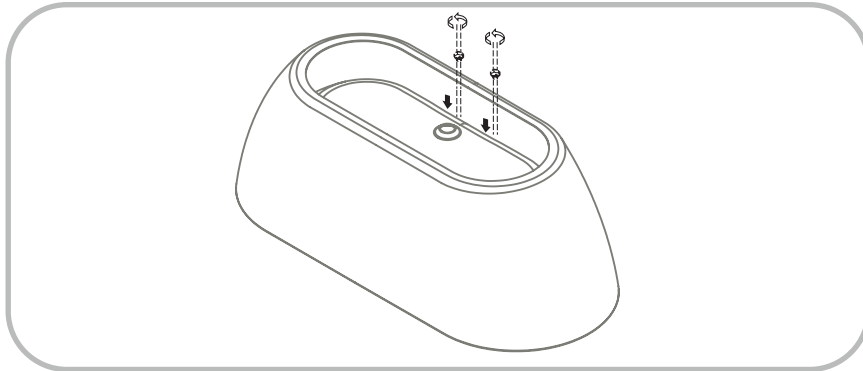

5

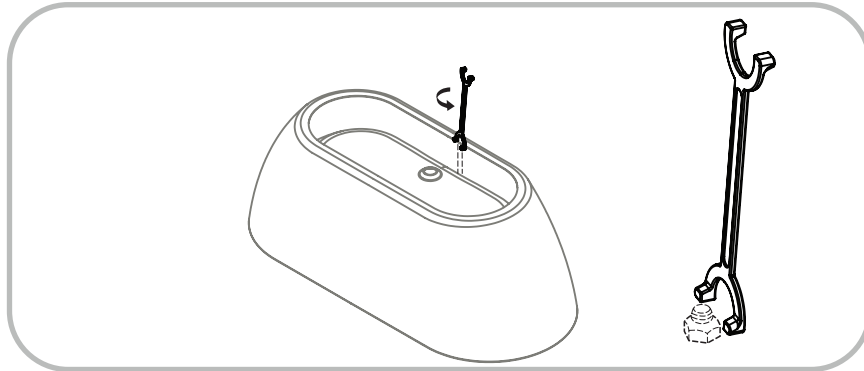

6

