

Uni-Axial Sine Table

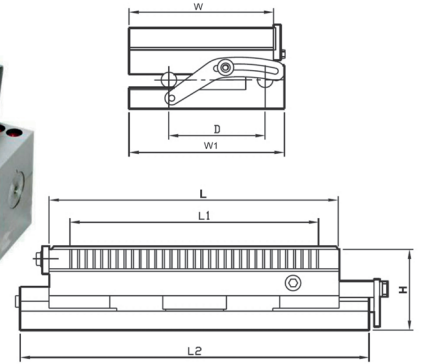

- A positive locking device is mounted on the base.
- Easy to use and a large effective area is provided for machining the works.
- This device provides positive locking at any angle without distortion.
- Constructed of hardened alloy tool steel.
 - * Angle precision: +5°
 - * Parallelism: 0.002/100mm ex-Factory.
 - Angle Range: 0 - 45°.
- Clamping Force: Up to 12 kg/cm².



Product Code : SS

All dimensions are in mm according to the effective magnetic area

Model No.	L	W	W1	L1	L2	D	H	Wt (Kgs)
SS-1370	130	70	70	101	171	75	84	5
SS-1710	175	100	115	140	216	75	84	10
SS-2510	250	130	141	206	311	100	84	19
SS-1515	150	150	161	108	191	125	84	13
SS-2515	250	150	161	206	311	125	84	22
SS-3015	300	150	161	257	361	125	84	26
SS-3515	350	150	161	305	411	125	84	30
SS-4015	400	150	161	357	461	125	84	35
SS-4515	450	150	161	407	511	125	84	40

Due to continuous upgradation in design there could be changes in specification. Other sizes on request. Before ordering, contact Supreme Magnets or your nearest dealer to confirm the suitability of this model for your application.



- Flat type for wide range of uses.
- Ideal for high accuracy grinding operations, EDM operations.
- Measurement of Angle accuracy.

Bi-Axial Sine Table



- A positive locking device is mounted on the base.
- Easy to use and a large effective area is provided for machining the works.
- Constructed of hardened alloy tool steel.
- Effective area of compound sine chuck is enlarged by employing the thin type permanent magnetic chuck.
- This increases the range of types usable by tilting works in length, breadth or composite angle.
- Double way sine plate, can grind two way angle at the same time.
 - * Angle precision: +5° | * Parallelism: 0.002/100mm ex-Factory
 - Angle Range: 0 - 45°
- Clamping Force: Up to 12 kg/cm².

Product Code : DS All dimensions are in mm according to the effective magnetic area

Model No.	L	W	W1	L1	L2	D	H	Wt (Kgs)
DS-1370	130	70	100	101	160	80	105	8
DS-1710	175	100	140	140	205	110	105	14
DS-2510	250	130	190	206	285	160	110	24
DS-2512	250	120	190	108	185	160	110	28
DS-3012	300	120	190	206	285	160	115	30
DS-1515	150	150	190	257	335	160	115	36
DS-2515	250	150	190	305	385	160	115	41
DS-3015	300	150	190	357	435	160	115	48
DS-3515	350	150	190	407	485	160	120	54

Due to continuous upgradation in design there could be changes in specification. Other sizes on request. Before ordering, contact Supreme Magnets or your nearest dealer to confirm the suitability of this model for your application.



- Flat type for wide range of uses.
- Ideal for high accuracy grinding, EDM & angle measurement operations.
- This is suitable for high precision angle grinding on a grinding machine and so on.

