

9x9 blower with 600W motor

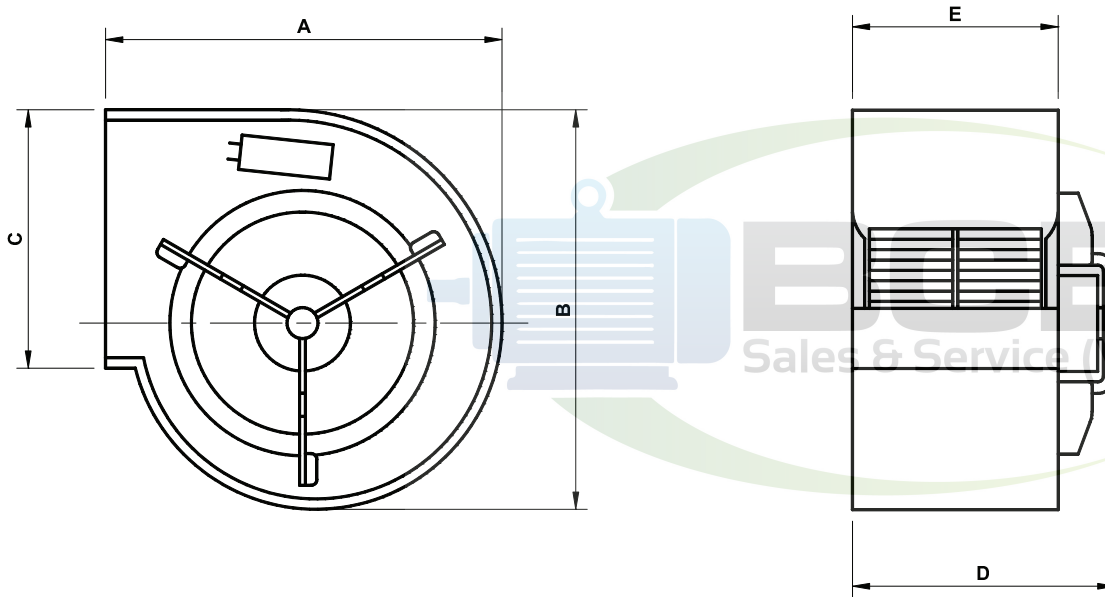

Part Number	A	B	C	D	E
FB 9x9-600-01	379	389	259	352	302

Motor					
Rated Output 600W	Supply 240V/50Hz	Rated RPM 1200	Rated Current 4.4 amps	Capacitor 15uF/440V	Insulation Class B 130
Enclosure IP20	Thermal Protection Auto Reset Overload		Duty AOM		

Wheels	
Glass Filled Nylon or Glass Filled Polypropylene with plated mild steel hub	

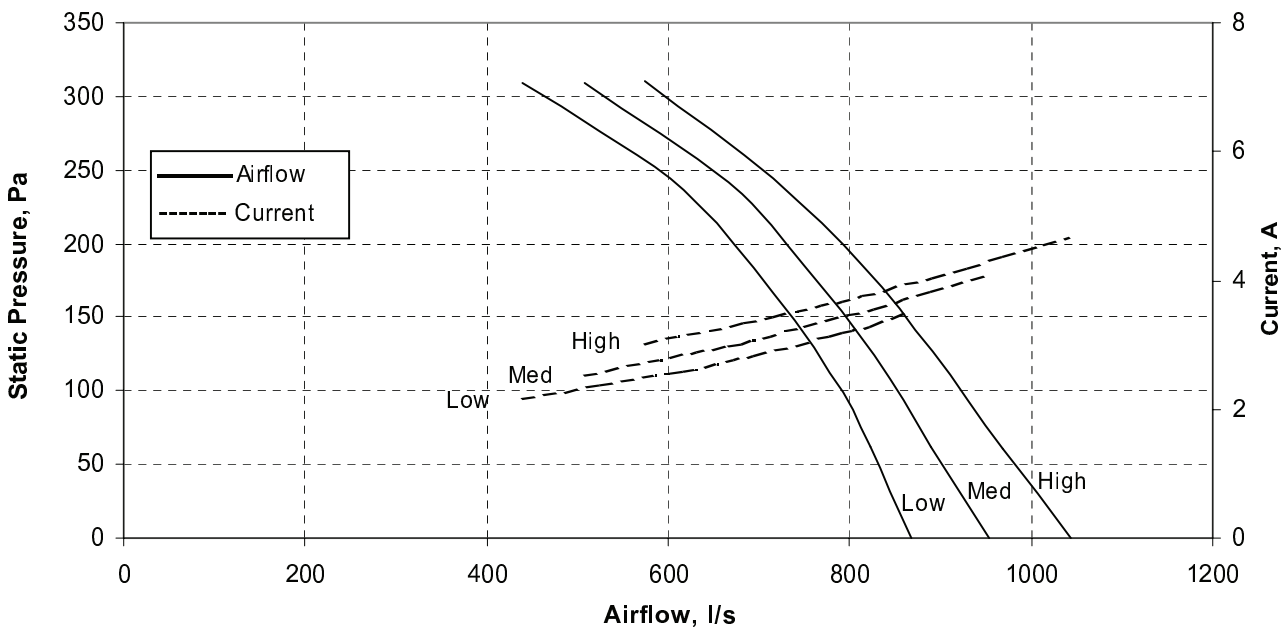

Dimensions

Product Data

Performance