

9x9 blower with 315W motor

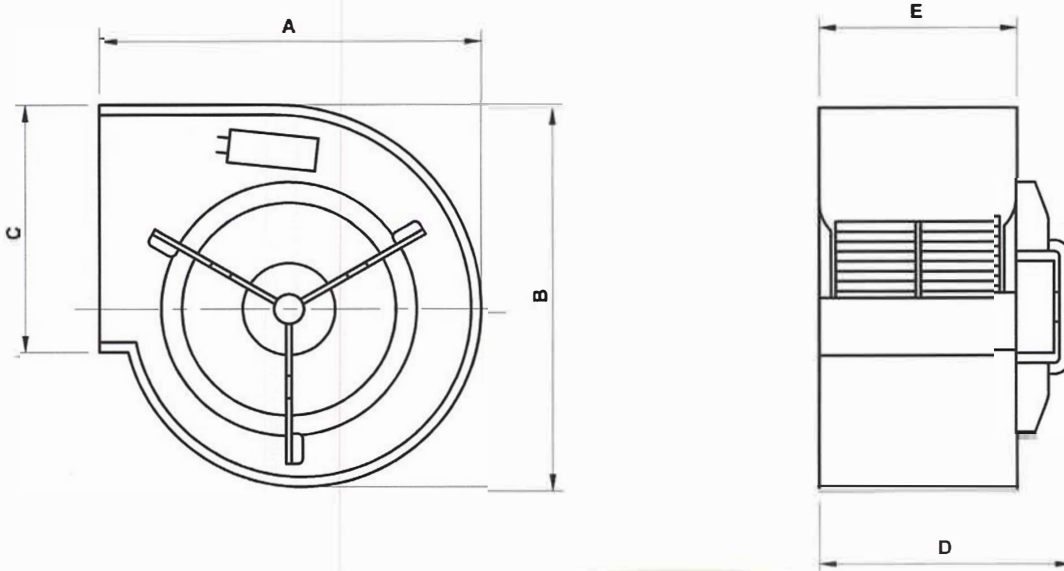

Part Number	A	B	C	D	E
FB 9x9-315-01	379	389	259	340	302

Motor					
Rated Output 315W	Supply 240V/50Hz	Rated RPM 1350	Rated Current 2.5 amps	Capacitor 4uF/440V	Insulation Class B 130
Enclosure IP20	Thermal Protection Auto Reset Overload		Duty AOM		

Wheels
Glass Filled Nylon with plated mild steel hub

Dimensions

Product Data

Performance

