

9x7 tight fan deck with 750W motor

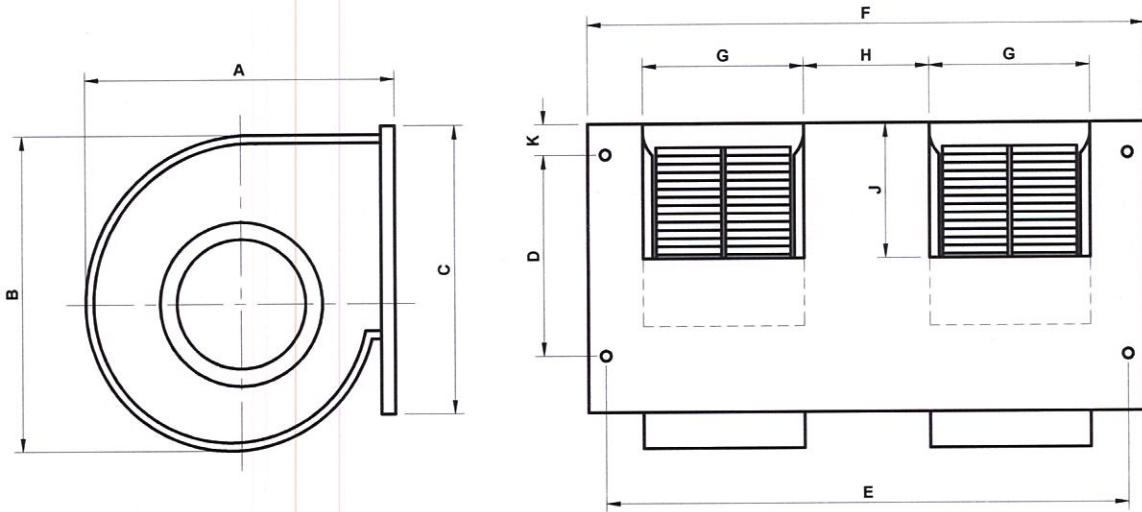

Part Number	A	B	C	D	E	F	G	H	J	K	Nutsert
FD 9x7T-750-05	320	325	311	262	765	816	235	227	169	25	M6
FD 9x7T-750-04	320	325	314	257	762	814	235	239	169	29	M6

Motor					
Rated Output 750W	Supply 240V/50Hz	Rated RPM 1360	Rated Current 4.9 amps	Capacitor 20uF/440V	Insulation Class B 130
Enclosure IP20	Thermal Protection Auto Reset Overload		Duty AOM		

Wheels
Glass Filled Nylon with plated mild steel hub

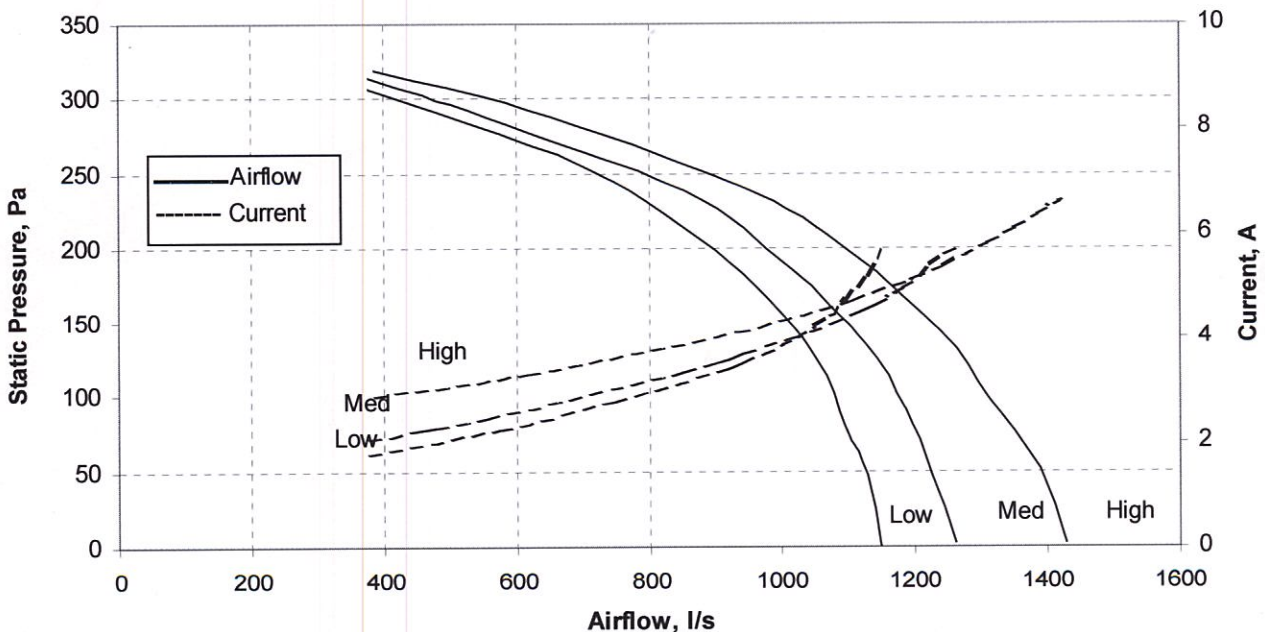

Dimensions

Product Data

Performance