

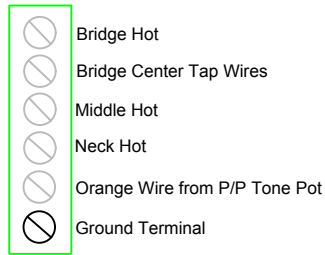

# TERMINATOR

## SVST-4/3

5-Way Super Switch  
Terminal Map



5-Way Super  
Selector

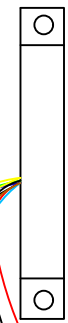

"Goes to Eleven"  
Volume Pot

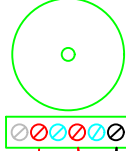

Cap

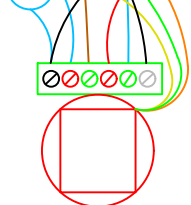

Transformed  
Operation  
"Yin-Yang"  
P/P Tone Pot

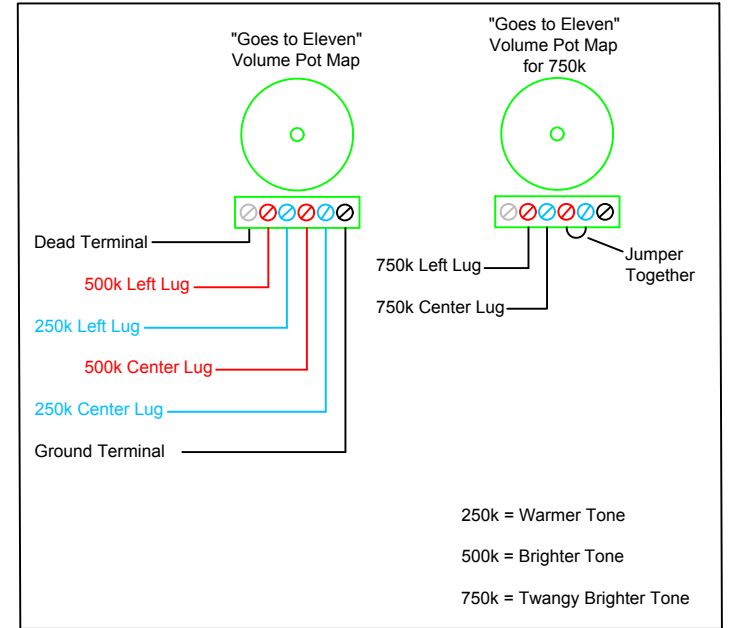
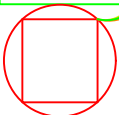

Neck pickup ground lead needs to be disconnected from pickup cover if connected. It's recommended a separate lead be attached and connected to ground.

Neck Pickup

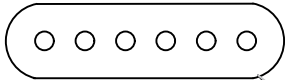

Middle Pickup

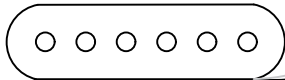

Bridge Pickup

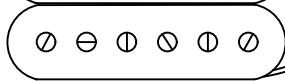
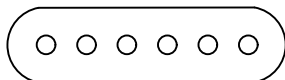

Four Wire Pickup Leads:  
Black - Hot  
Red & White - Center Tap  
Green & Shield - Ground

Ground Terminals (black):

- All components must be interconnected with a ground wire
- Avoid placing more than three wires per Ground Terminal
- Pickup shields and ground wires can be placed on any Ground Terminal
- Dead Terminals can be utilized as an additional ground wire landing point by placing a jumper from a Ground Terminal to the Dead Terminal

Pickup wire colors may differ than yours.  
See "Pickup Cross Reference Chart" at  
[madhatterguitarproducts.com](http://madhatterguitarproducts.com)  
to verify your pickup wire color configuration.

The Terminator is Patent Pending

Customer Support:  
[info@madhatterguitarproducts.com](mailto:info@madhatterguitarproducts.com)

# Please watch our Installation Videos!!!

## Beware of tight fitting knobs!

Forcing a 6mm metric knob with a course 18 tooth knurl onto our pots will damage them. Our pots have a ¼" 24 tooth fine knurl **brass** shaft. (Terminator EVO volume and certain P/P Pots do have a 6mm shaft. They have aluminum shafts.)



You can enlarge the inside diameter of your metric knob to better fit a standard ¼" diameter shaft by using a 7/32" drill bit. By hand carefully twist the 7/32" drill bit into your knob. This will slightly open up the inside diameter.



Set screw style knobs work great with our pots. To install place the screw of the knob over the gap on the spline shaft and tighten screw into gap.

When installing selector switches make sure the following sides (metal/spring) are facing down when holding your instrument. This will ensure correct operation.



CRL



OakGrigsy

## Basic Installation Instructions:

- Carefully remove all components being replaced by the Terminator
- Cut solder off remaining wires, grounds and pickup wires, and strip wires back approximately 1/8"
- Using painter's tape, tape wires to the guitar body away from the control cavity
- Carefully install Mad Hatter components into guitar. For small control cavities, wire components outside of control cavity and install in guitar after wiring
- Tape wires related to the Mad Hatter components away from the control cavity
- Determine your desired value of each Potentiometer and note where to attach wires
- Following the wiring instructions, attach needed wires between Mad Hatter components using wire provided with Kit. All components need to be connected together with a black ground wire
- **Attached pickup, bridge, output jack and all other ground wires to ANY of the ground lugs.** If needed you can also utilize one of the unused Dead Terminals with a jumper wire from a ground terminal if more ground connection points are needed
- Attach Red wire from Output Jack as per instructions
- Individually attach each pickup as per instructions
- Attach desired tone cap to tone pot, Blue leads = .022uf, Black leads = .047uf.
- Ensure all wires are properly attached and no stray wires touching other components
- Test to ensure everything is operating correctly
- Route wires within control cavity and close up

**\*\*\*Note - Only use the Little Ass Screwdriver provided with the Kit. A larger screwdriver may damage components\*\*\***

## Basic Troubleshooting -

No Sound - Typically shorted wire, check for shorted wires, or wires not connected properly

Loud Hum - Typically an open signal, recheck connections

Hums when hands leave strings - Check bridge ground wire is attached and all other ground wires are properly attached. Also double check all components are interconnected with a ground lead