

CLAYMORE ULTRA 3.0

CLAYMORE ULTRA 3.0 S/M/L/X

CLC-900BK / CLC-1400BK / CLC-1900BK / CLC-2800BK

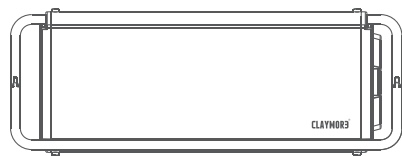
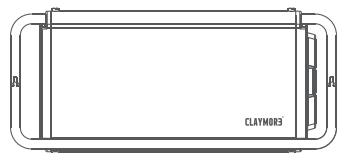
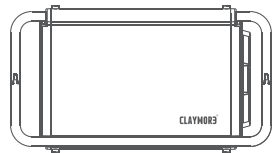
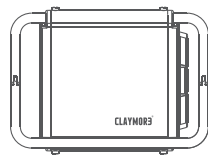

User Manual

This portable light contains a Li-ion battery. Please follow the user manual before use. If any abnormality is found in the product, discontinue use and contact the dealer or a service center where the product was purchased. Any modifications of this product will void the warranty. Misuse of CLAYMORE products may cause user harm.

1. Caution

- ① Do not use near high temperatures such as fires or heating equipments. It may cause explosion or ignition.
- ② This product is water resistant. However, if left in the rain for a long time, it may cause malfunction. If the product gets soaked, please quickly wipe it off.
- ③ Do not store or use in vehicles exposed to direct sunlight. It may cause explosion and malfunction.
- ④ Do not touch the light source directly as it may become very hot during use. Use handle to carry out.
- ⑤ Do not use if it exceeds the operating temperature range (-10 °C to 40 °C).
- ⑥ Do not use external power other than USB 5V. It may cause heat and ignition.
- ⑦ Please do not place in the reach of infants. It may cause swallowing of parts or injury.
- ⑧ Adult supervision is necessary when used by children. Misuse of light may cause injury or electric shock.
- ⑨ Do not insert any metal parts into the terminal block of the connector. It may cause heat, explosion or electric shock.
- ⑩ Do not disassemble or modify the product.
- ⑪ Do not touch the connector with wet hands. There is a danger of electric shock.
- ⑫ After use, be sure to turn off the power.
- ⑬ If the product is dropped or experiences physical shock, damage may be accumulated inside the product and unexpected malfunction may occur even during normal use. Be careful not to apply physical shocks to the main unit.

2. Components

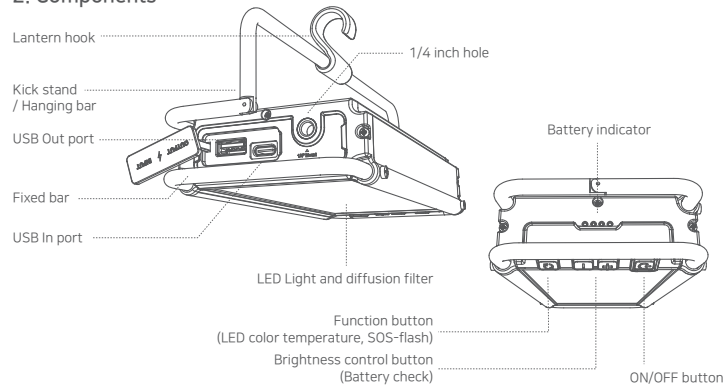

3. Operation

● Charging

- 1) As shown in the figure, open the cover and connect the USB cable to the charging port. Charging time may vary depending on battery capacity and external environment.



※ Please charge with the supplied USB cable with 5V 2A / 9V 2A / 12V 1.5A smart quick charger.

- 2) When the product is being charged, the battery level indicator flickers. If the light is not flicking and all the lights are on, it indicates that the battery has been fully charged.

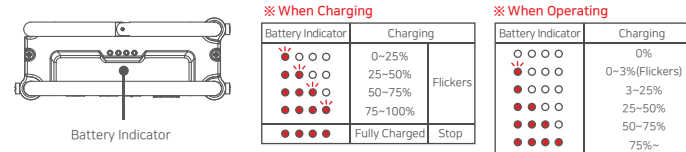

※ When the battery capacity is less than 4%, Battery check and power bank functions may not activate.

● Operation

1. On / Off: Press (⏻) shortly to turn on light. Repeat to turn off light.
 2. Step dimming: Press (+) (-) button to sequence to adjust brightness in 5 steps. Stepless Dimming: Press and hold (+) (-) button to adjust brightness
 3. Battery level check: Press (⏻) button once in power ON or OFF status, the battery level is displayed in 4 steps.
 4. LED Color Change: When the power is ON, pressing (⊞) function button once enables adjusting the light color in three steps in order of Warm > Bright > Cool
- | | |
|--------|--|
| Warm | LED light with low color temperature, warm light feels like ordinary gas lantern |
| Bright | LED light with a neutral color of daylight and light bulb and comfortable feeling
Turbo Mode: Using Bright mode doubles the brightness, but run time will decrease |
| Cool | LED light with high color temperature, cool light feels like ordinary fluorescent light |
5. SOS-flash: Press and hold (⊞) button for 2 seconds from ON states to activate the SOS distress signal. Press (⊞) button once again to stop SOS flash.
 6. Lock Mode: When light is off, press down (⏻) button, then press and hold (⏻) button over 5sec to start lock, repeat to unlock.
※ Light blinks once when starting Lock and Unlock

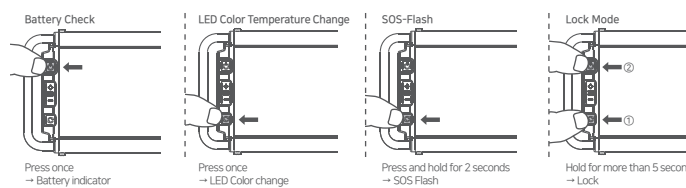

● Power Bank Function

Claymore Ultra models offer smart quick charge. Connect various devices and lantern with USB cable from USB out port and it will automatically start charging. (On status : Battery indicator turns on)

The power bank function is automatically turned off to prevent battery power consumption when not in use.

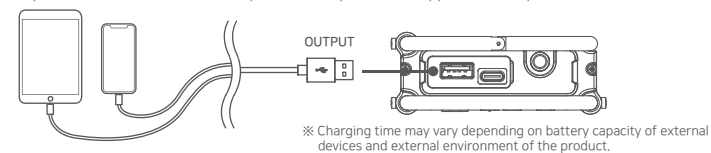

4. Installation

● Hang on a lantern hook or string

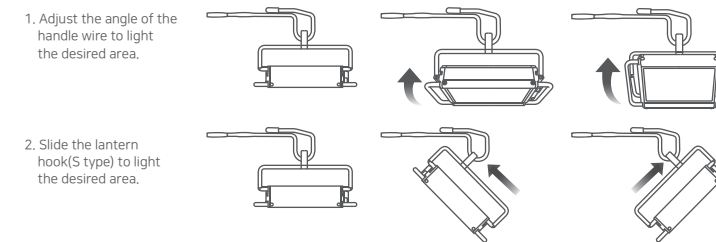

● If the product is placed on a table or on a flat surface

1. This light can be mounted vertically or horizontally at an angle that requires illumination.
2. If you turn the handle wire as shown in the figure and turn it diagonally, you can mount it at the desired angle that requires illumination.

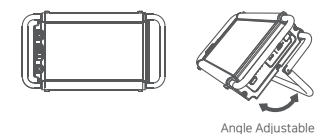

● Camera tripod mount

Turn the handle and connect with fixing screw on the camera tripod into the socket and rotate.

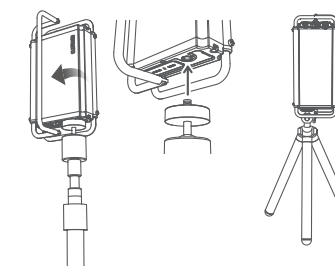

5. In Case of Malfunction

* If there is something wrong with the product, please check the following first.

1. If it does not activate, check the charging status.
2. If the external device cannot be charged, check the On state of the function button

6. Specification

Product name	CLAYMORE ULTRA 3.0,S	CLAYMORE ULTRA 3.0,M	CLAYMORE ULTRA 3.0,L	CLAYMORE ULTRA 3.0,X	
Model name	CLC-900BK	CLC-1400BK	CLC-1900BK	CLC-2800BK	
LED color temperature	Warm : 3000K , Bright : 4200K , Cool : 6500K (±15%)				
Brightness (lumen)	Cool,Warm	30~600 Lm	40~1,100 Lm	50~1,350 Lm	60~1,600 Lm
	Turbo(Bright)	60~1,200 Lm	80~2,200 Lm	100~2,700 Lm	120~3,200 Lm
Run time	Cool,Warm	7~50hour	8~80 hour	11~100 hour	13~150 hour
	Turbo(Bright)	3.5~25hour	4~40 hour	5.5~50 hour	6.5~75 hour
Size	120×90×34mm	160×90×34mm	200×90×34mm	240×90×34mm	
Weight	270g	405g	540g	680g	
Battery type Battery capacity	Li-ion 3.6V 7,000mAh(25.20Wh)	Li-ion 3.6V 11,600mAh(41.76Wh)	Li-ion 3.6V 17,400mAh(62.64Wh)	Li-ion 3.6V 23,200mAh(83.52Wh)	
	Charging time	2 hour 30 minute (Quick charge adapter)	6 hour (Quick charge adapter)	7 hour (Quick charge adapter)	8 hour (Quick charge adapter)
INPUT	USB 5V 2A / 9V 2A / 12V 1.5A				
OUTPUT	5V 2A / 9V 2A / 12V 1.5A				
Origin	MADE IN KOREA				

7. Contents



⚠ Caution for long-term storage

- * If the battery is completely drained, the battery indicator might not flash. If this happens, plug the USB cable back in or press the button to turn the battery indicator on again.
- * For long-term storage, fully recharge the battery. (Repeat every six months)
- * Please keep in mind that if stored below -10°C the battery life may be affected.
- * Please keep in a dry place without moisture.

Warranty

Item	CLAYMORE ULTRA 3.0,S	CLAYMORE ULTRA 3.0,M	CLAYMORE ULTRA 3.0,L	CLAYMORE ULTRA 3.0,X
Model No.	CLC-900BK	CLC-1400BK	CLC-1900BK	CLC-2800BK
Seller				
Date of Purchase				

1. Thank you for purchasing CLAYMORE series of Prism Co., Ltd.
2. This product has passed strict quality control tests. If the product is not functioning properly, please contact an authorized service center.

Free Service

- 1) Failure of the product under normal operating conditions during the warranty period will be repaired by Prism or authorized service center on free of charge. Some shipping or handling charges may be involved.
- 2) Warranty period: 1 year

Charged Service

- 1) Damage caused when the warranty period is over.
- 2) Damage caused due to the user's mishandling, abuse, or improper operation.
- 3) Damage caused by arbitrary or personal repair or disassemble in unauthorized service center.
- 4) Damage from input electricity or cable defect.
- 5) Damage caused by natural disaster.

CLAYMORE

Prism Co., Ltd.
101-1501, Chunui-Technopark, Bucheon-ro 198 Road, 36, Bucheon-si, Gyeonggi-do, Korea
www.claymorelight.com · www.prismlight.co.kr · info@prismlight.co.kr