



Ford Ranger Raptor

Seilwindenanbau Ford Ranger Raptor

Art.Nr.: 2147485349

Anbauanleitung: Seilwindenanbausatz Ford Ranger Raptor ab2019

AL: 2238-00

Best.Nr.: 16-8340

Montagezeit: ca. 360 min.

*Hier sehen sie den fertig montierten Seilwindenanbausatz.
Bevor sie mit der Montage beginnen, lesen sie bitte diese Anleitung und das
Benutzerhandbuch der Seilwinde gut durch.*

*Before you start fitting, please read and understand this instruction manual and the owners
manual of the winch.*



Einbauanleitung Seilwindenanbau Ford Ranger Raptor • ©ORP • Revision 06.07.2022



ORP
Off-Road-Products

■ Vorholzstraße 5, 89343 Jettingen-Scheppach OT: Ried
■ Tel. +49 (0)8225 309045

■ info@off-road-products.de
■ www.off-road-products.de



Ford Ranger Raptor

Seilwindenanbau Ford Ranger Raptor

Art.Nr.: 2147485349

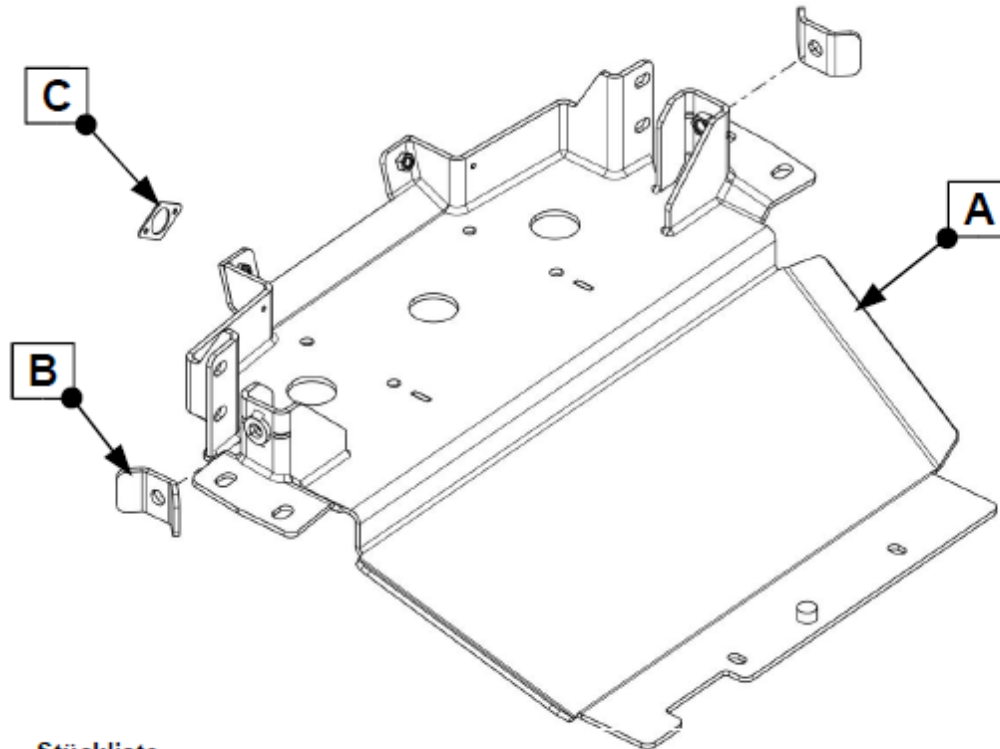

Stückliste

16-834

Schraubensatz

1x Windenplatte (A)
2x Beilage (C)
1x Steckdosenblech (C)

1x 1-90395,
WARN Steckdosenverlängerung 2-tlg, für
Fernbedienung

1x Anbauanleitung AL2238
1x Gutachten
1x Aufkleber Kennzeichnung
(Bitte an einer sichtbaren Stelle
anbringen! TÜV Relevant)

2x Schraube M14 x 100
6x Scheibe M14
2x Federring M14

2x Schraube M6 x 16
2x Scheibe M6 x 30 x 1,25
2x Federring M6

2x Linsenflachkopfschraube M5 x 35
4x Scheibe M5
2x Federring M5
2x Mutter M5

Schrauben Anzugsmomente siehe letzte Seite!
For torque information please see last page!

Einbauanleitung Seilwindenanbau Ford Ranger Raptor • ©ORP • Revision 06.07.2022



ORP
Off-Road-Products

■ Vorholzstraße 5, 89343 Jettingen-Scheppach OT: Ried
■ Tel. +49 (0)8225 309045

■ info@off-road-products.de
■ www.off-road-products.de



Ford Ranger Raptor

Seilwindenanbau Ford Ranger Raptor

Art.Nr.: 2147485349

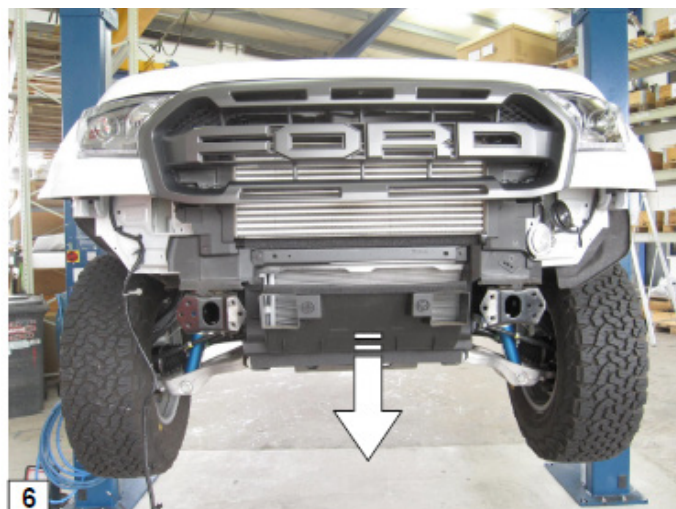
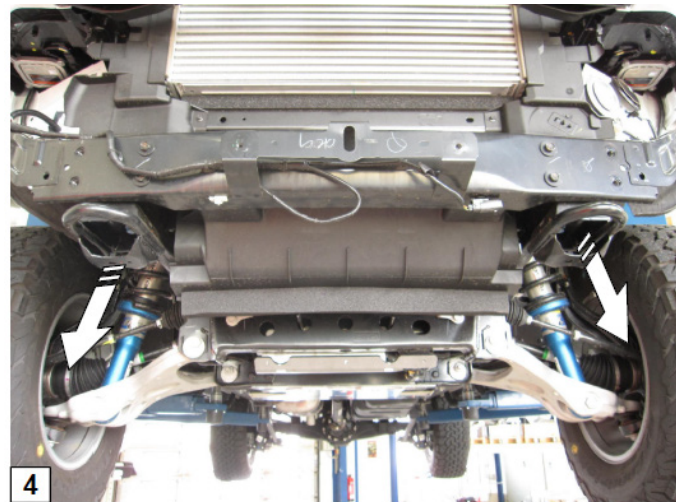

Einbauanleitung Seilwindenanbau Ford Ranger Raptor • ©ORP • Revision 06.07.2022



■ Vorholzstraße 5, 89343 Jettingen-Scheppach OT: Ried
■ Tel. +49 (0)8225 309045

■ info@off-road-products.de
■ www.off-road-products.de



Ford Ranger Raptor

Seilwindenanbau Ford Ranger Raptor

Art.Nr.: 2147485349

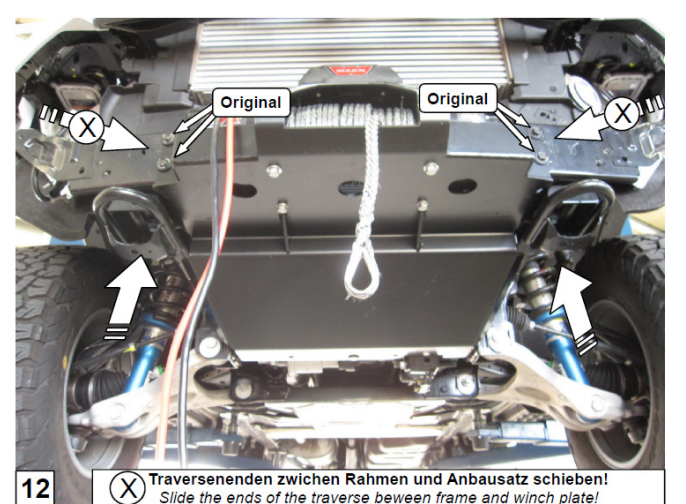
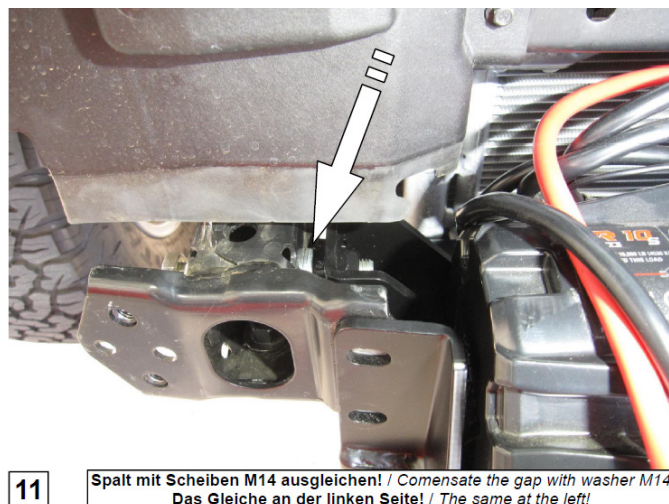
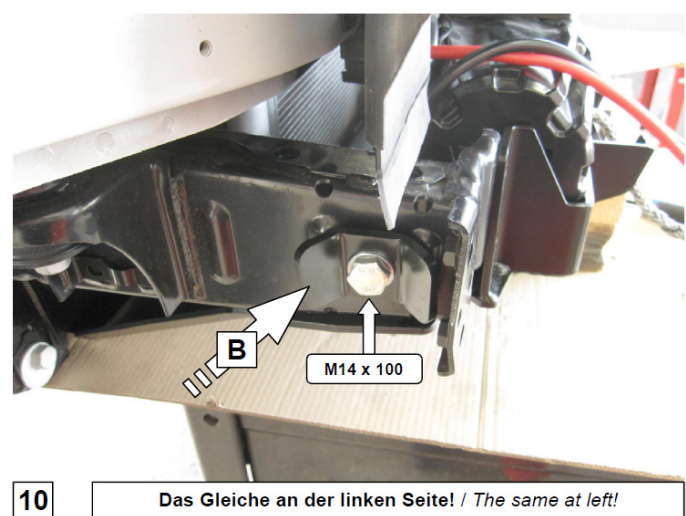
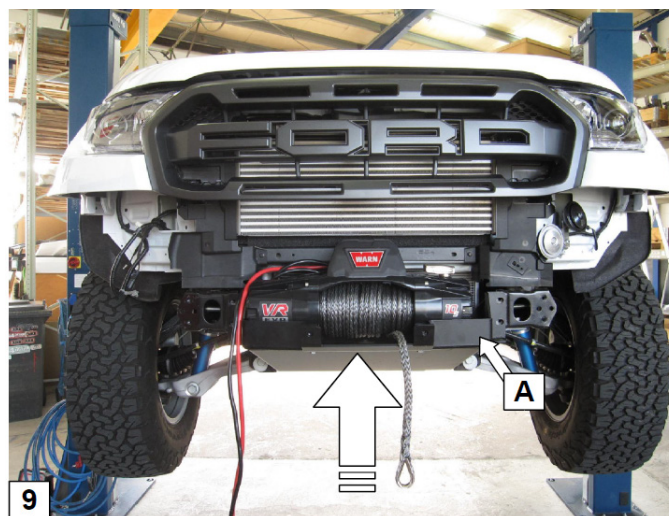
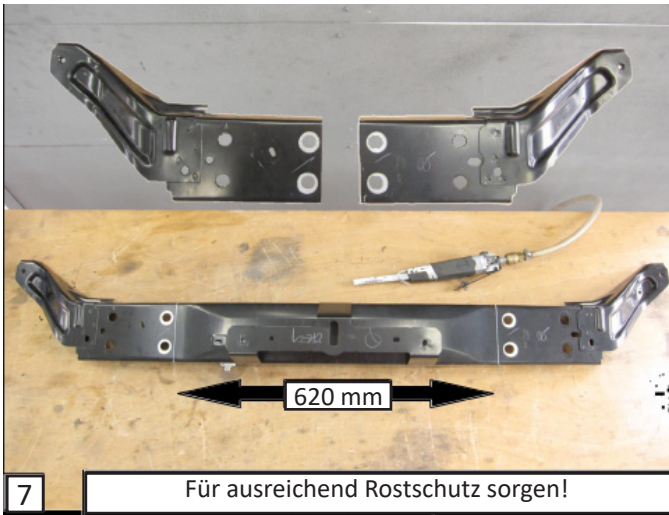

Einbauanleitung Seilwindenanbau Ford Ranger Raptor • ©ORP • Revision 06.07.2022



■ Vorholzstraße 5, 89343 Jettingen-Scheppach OT: Ried
■ Tel. +49 (0)8225 309045

■ info@off-road-products.de
■ www.off-road-products.de



Ford Ranger Raptor

Seilwindenanbau Ford Ranger Raptor

Art.Nr.: 2147485349

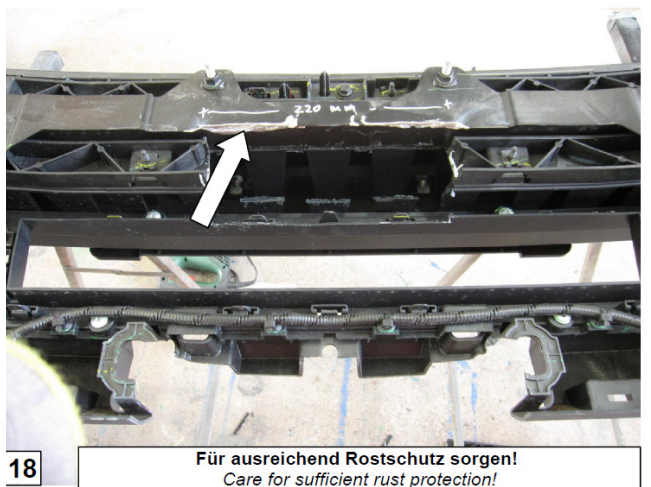
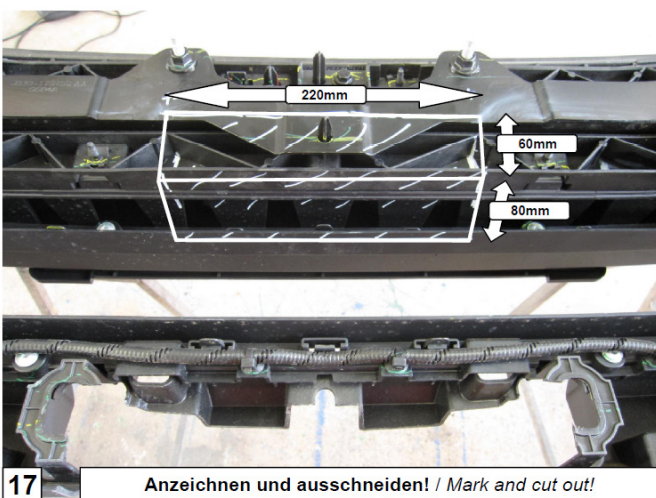
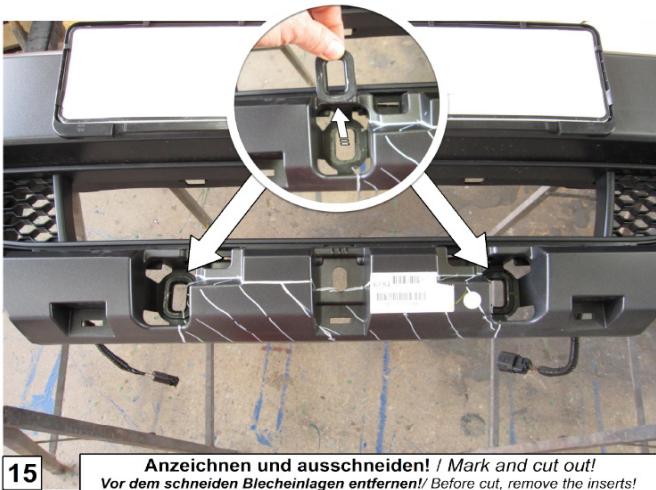
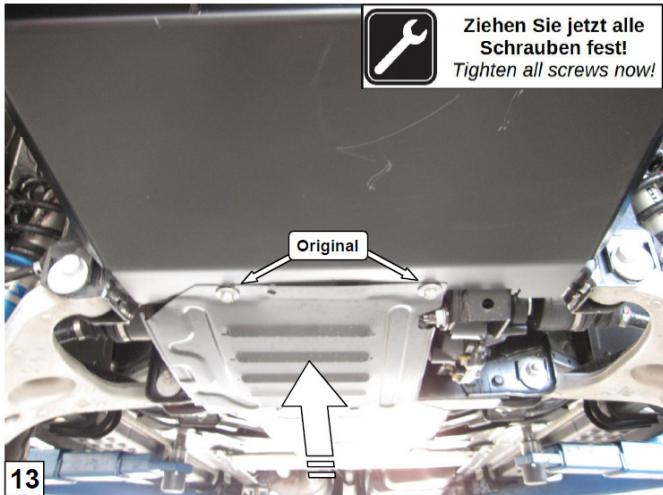

Einbauanleitung Seilwindenanbau Ford Ranger Raptor • ©ORP • Revision 06.07.2022



■ Vorholzstraße 5, 89343 Jettingen-Scheppach OT: Ried
 ■ Tel. +49 (0)8225 309045

■ info@off-road-products.de
 ■ www.off-road-products.de



Ford Ranger Raptor

Seilwindenanbau Ford Ranger Raptor

Art.Nr.: 2147485349

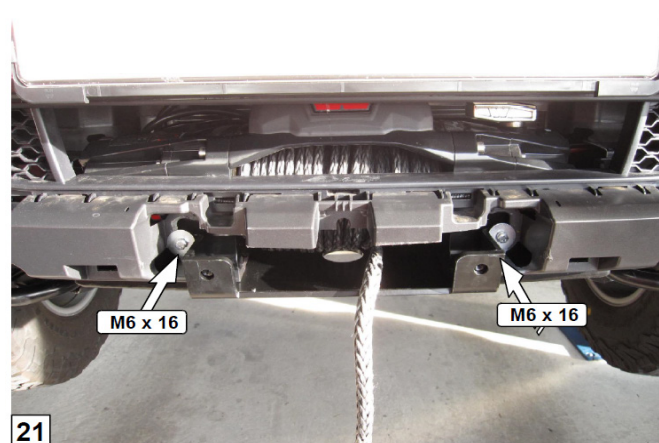
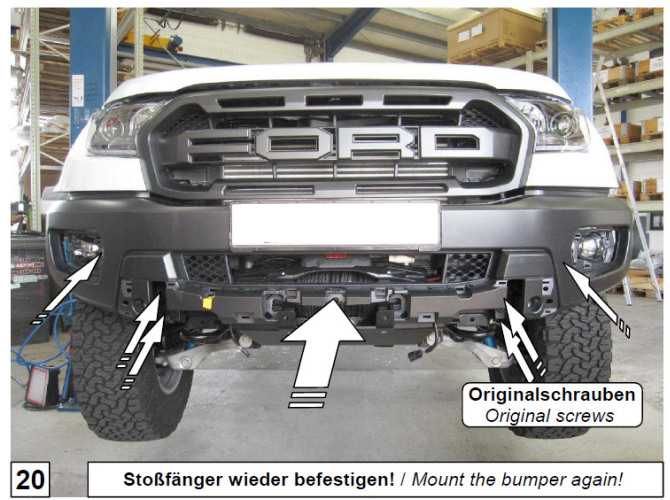

Einbauanleitung Seilwindenanbau Ford Ranger Raptor • ©ORP • Revision 06.07.2022



ORP
Off-Road-Products

■ Vorholzstraße 5, 89343 Jettingen-Scheppach OT: Ried
■ Tel. +49 (0)8225 309045

■ info@off-road-products.de
■ www.off-road-products.de



Ford Ranger Raptor

Seilwindenanbau Ford Ranger Raptor

Art.Nr.: 2147485349



25 Alu Seilfenster montieren! / Mount the aluminium-fairlead!

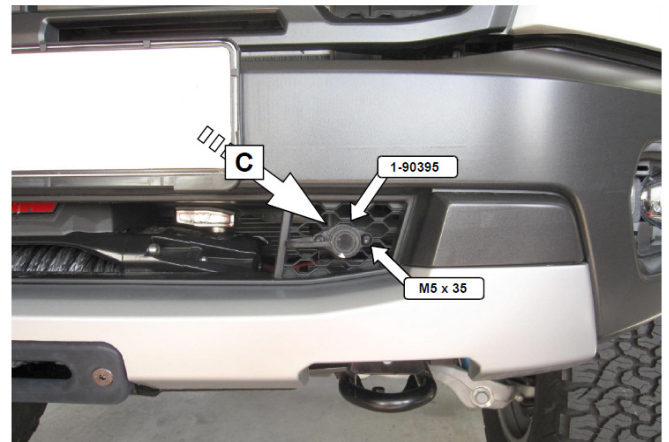

26 Steckdose einsetzen! / Mount the socket!
Teil „C“ hinter dem Gitter / Part „C“ behind the grid



27 Bei Fahrten auf öffentlichen Straßen den Seilhaken einhängen!
Hang the hook in if drive on public roads!

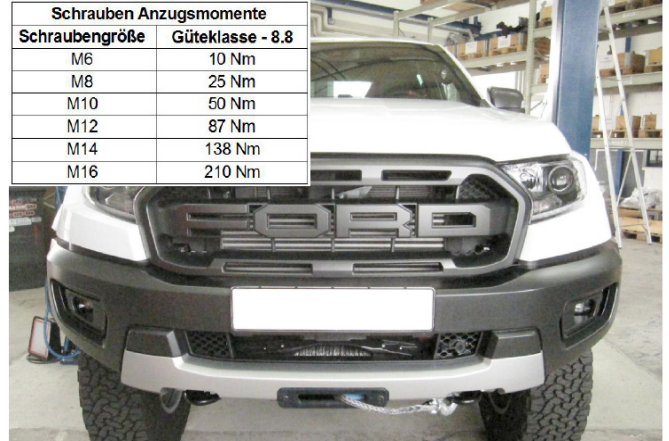

28 Fertig / finish

Schrauben Anzugsmomente	
Schraubengröße	Güteklasse - 8.8
M6	10 Nm
M8	25 Nm
M10	50 Nm
M12	87 Nm
M14	138 Nm
M16	210 Nm



Wir empfehlen die Montage von einer Ford-Werkstatt durchführen zu lassen. Schäden, die durch eine fehlerhafte Montage entstehen, sind nicht durch die Garantie gedeckt.



Einbauanleitung Seilwindenanbau Ford Ranger Raptor • ©ORP • Revision 06.07.2022



ORP
Off-Road-Products

■ Vorholzstraße 5, 89343 Jettingen-Scheppach OT: Ried
■ Tel. +49 (0)8225 309045

■ info@off-road-products.de
■ www.off-road-products.de