

# Sprung Handle Installation Instructions

## Contents

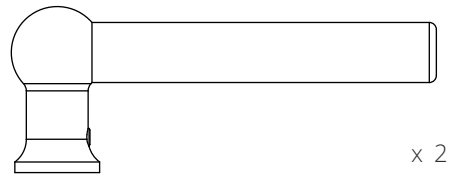

Handles

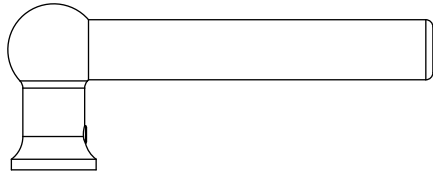
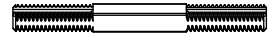

Threaded Spindle x 1

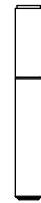

Thread Lock x 1



Grub Screws x 2



Grub Screws with pre-applied threadlock x 2

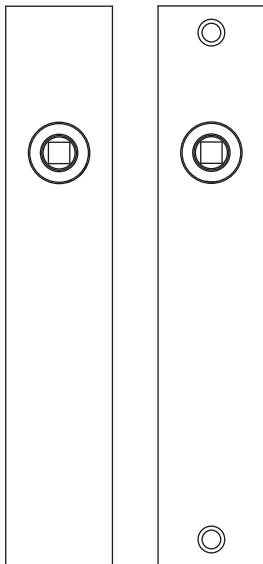

Flat Plate Long Lever x 2

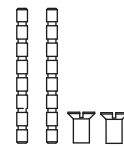

M4 Through Bolts x 2

## Sprung Handle Installation Instructions

### Tools you'll need

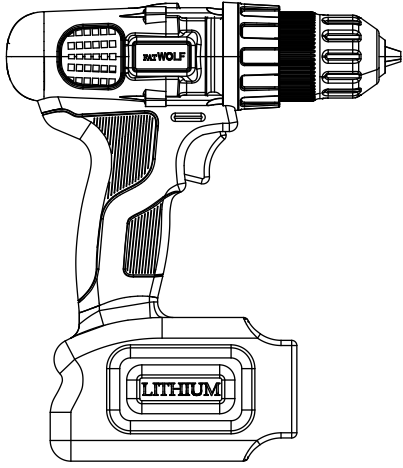

Drill

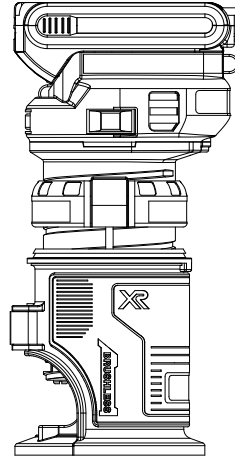

Palm Router

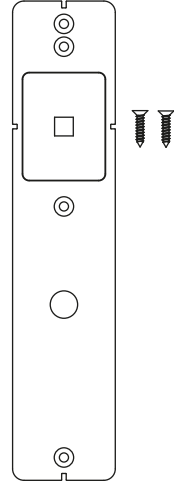

Installation Jig  
(18247)

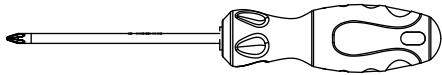

Flat Head Screw Driver

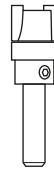

Router Bit (17101)



PZ2 Driver Bit



10mm Drill Bit

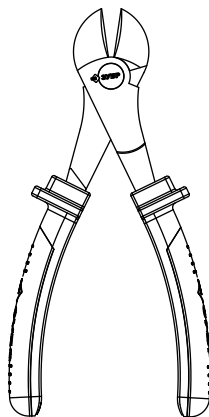

Pliers



Wood Working Chisel

When installing the handles in to a new door we suggest drilling the pocket for the latch to sit in to first, and then drilling the holes for the door handle

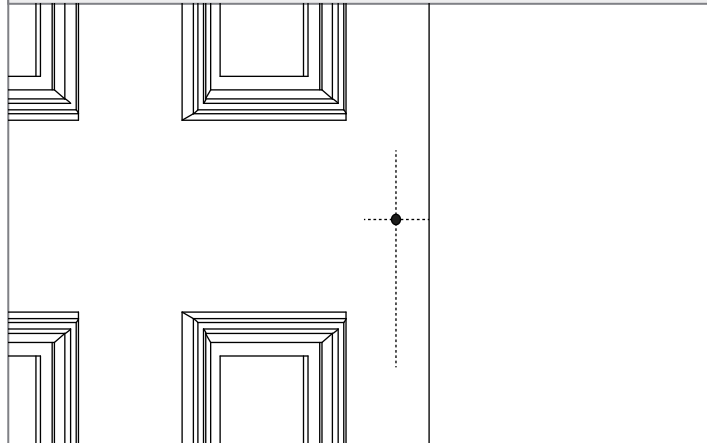
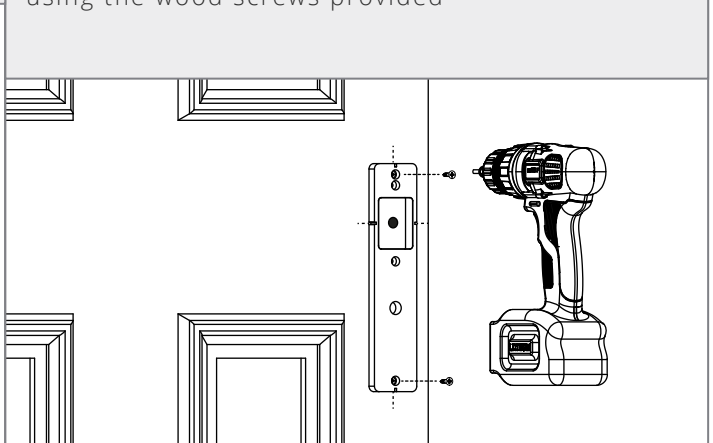
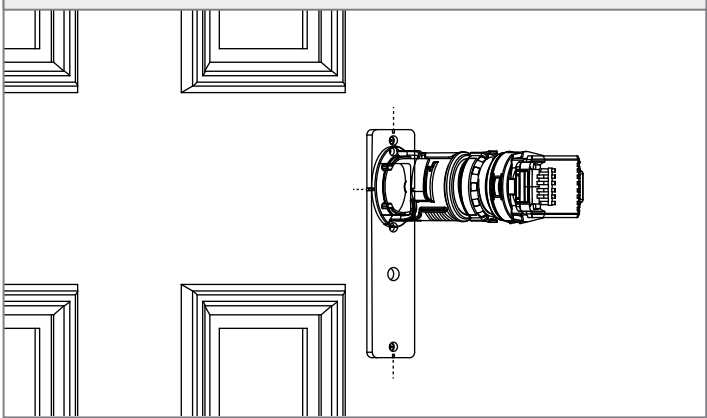
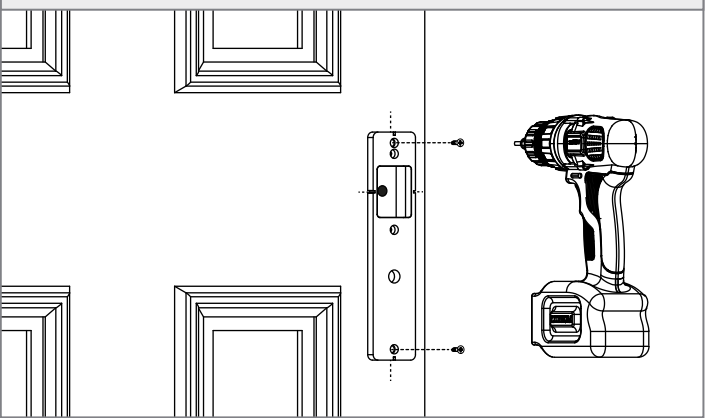
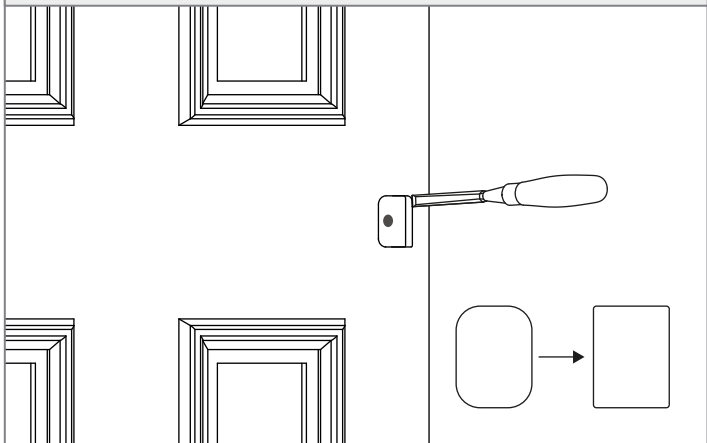
1 Mark the centre lines on both sides of the door based on the existing spindle hole	2 Line the jig (18247) up using the notches in the jig and lines on the door. Screw the jig to the door using the wood screws provided
	
3 Using a palm router and the router bit (17101), route out a pocket 10mm deep into the door	4 Unscrew the jig from the door
	
5 Using a chisel remove the radiused corners from the pocket	
	Repeat steps 2, 3 and 4 on the other side of the door

**Installation**

<p>6 Using the screw holes as a pilot hole, carefully drill out the through holes with a 10mm drill bit</p>	<p>7 Clip snap off screws to size so that they are smaller than the depth of the door</p>

<p>8 Screw the threaded bar through the plate and door into the lugs on the back of the second plate</p>	<p>9 Place the spindle through plates, using a flat head screwdriver carefully tighten up the screws</p>

<p>11 Screw roses and handles on to the spindle, leaving a small gap between the rose and handle.</p>	<p>12 If after screwing the handle on there is a gap bigger than a 1mm between the handle and rose, use the washer to fill the gap</p>

### Installation

<p>13 Screw grub screws in, making sure the handle is level. Ensure the spindle is orientated so the grub screw is screwed in to the groove in the spindle</p>	<p>14 Check handle turns smoothly</p>
<p>15 Remove handles</p>	<p>16 Apply thread lock to spindle re-install handle</p>
<p>17 Replace the grub screw in the handle for the grub screws with pre-applied thread lock</p>	<p>18 Re-install and wait for thread lock to set</p>

Depending on the orientation of the door, latch and the plates you may need to switch the mechanism on the back of the plates. This is an easy process that only requires a couple of steps

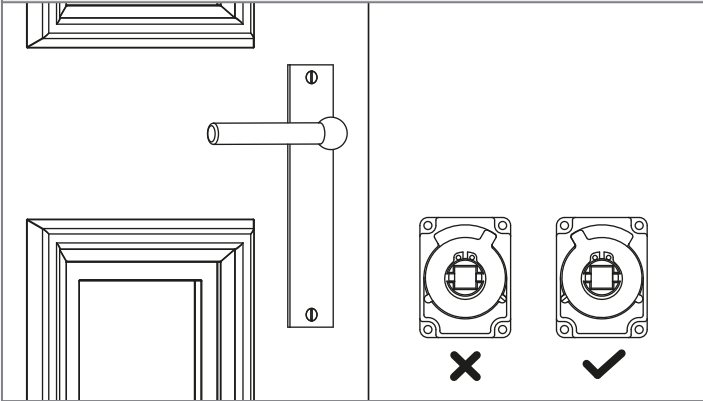
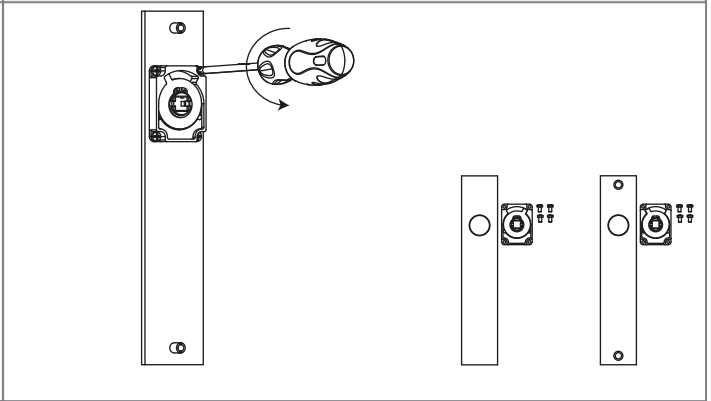
<p>1 Looking at the back of the plate check that the limiter tab of the mechanism is facing towards the hinges. If not then move to step 2</p>	<p>2 Unscrew the mechanisms from the back of the plates</p>
	

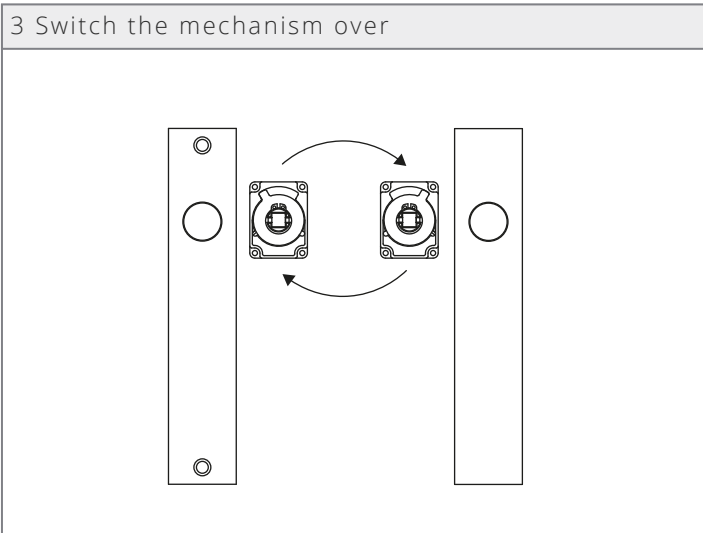
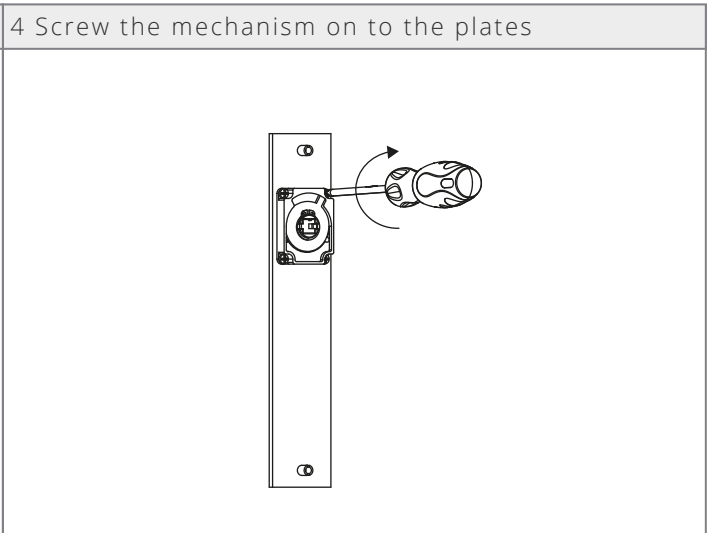
<p>3 Switch the mechanism over</p> 	<p>4 Screw the mechanism on to the plates</p> 
--	---

5 Install handles in to the door

