

# *ProBreeze*<sup>®</sup>

## Instruction Manual

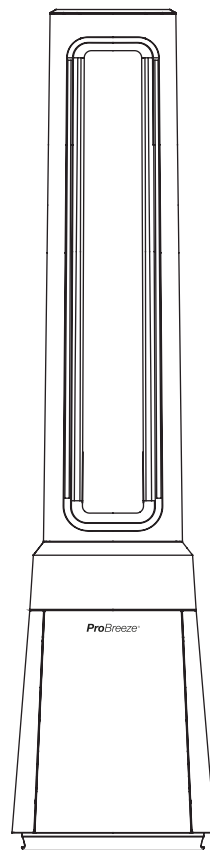

### Model PB-F-22

Bladeless Tower Fan with HEPA Filter

**IMPORTANT INSTRUCTIONS  
– RETAIN FOR FUTURE USE**

# CONTENTS

<b>EN</b> Safety Instructions.....	Page 3
Battery Instructions.....	Page 5
Specification.....	Page 7
Parts .....	Page 7
Operating Instructions.....	Page 13
Cleaning and Storage.....	Page 14
Recycling and Disposal.....	Page 15

**ProBreeze**®

**BLADELESS TOWER FAN  
MODEL PB-F-22**

Thank you for choosing to purchase a product from Pro Breeze. Please read the entire manual carefully prior to first use and keep in a safe place for future reference.

## **SAFETY INSTRUCTIONS**

### **PLEASE READ AND SAVE THESE IMPORTANT SAFETY INSTRUCTIONS.**

When using electrical appliances, basic safety precautions should always be followed to reduce risk of fire, electric shock, and injury to persons, including the following:

**⚠ WARNING: TO AVOID THE RISK OF ELECTRICAL SHOCK, FIRE OR INJURY TO PEOPLE, ALWAYS MAKE SURE THE APPLIANCE IS UNPLUGGED FROM THE ELECTRICAL OUTLET BEFORE RELOCATING, SERVICING, OR CLEANING IT.**

- Use the appliance only as described in this manual. Any other use not recommended by the manufacturer may cause fire, electric shock or injury to person.
- Do not cover the appliance whilst in use.
- Always unplug the appliance when not in use.
- Keep the appliance out of reach of children and pets.
- Do not leave children alone or unattended in the area.
- Children should not play with the appliance.
- Cleaning and user maintenance shall not be made by children without supervision.
- The appliance can be used by children aged from 8 years and above and persons with reduced physical, sensory or mental capabilities or lack of experience and knowledge if they have been given supervision or instruction concerning use of the appliance in a safe way and understand the hazards involved.
- The appliance must have a minimum 50cm clearance around all sides of the appliance. Take care that curtains

or other objects are not sucked into the fan during the operation.

- Never leave the appliance unattended while in use.
- Always turn the appliance off and disconnect from the power supply when not in use.
- Avoid placing the power cord in areas where it can become a tripping hazard. Do not place the power cord under carpeting or cover it with rugs, runners or similar.
- Place the appliance on a flat, stable and dry surface and always keep the appliance in an upright position. Operating the appliance in any other position could cause a hazard.
- Never place anything on top of the appliance.
- Ensure the mains supply (including voltage, frequency and power) complies with the rating label of the appliance.
- There may be trace of odour during the first few minutes of initial use. This is normal and will quickly disappear.
- Do not cover the appliance or restrict the airflow of the inlet or exhaust grills whilst in use.
- Do not use this appliance to dry clothes.
- Do not use the appliance in high humidity or steam-filled rooms.
- Do not operate the appliance with wet hands.
- Do not operate the appliance without the filter.
- Do not use this appliance near water or in the immediate surroundings of a bath, shower or swimming pool. Never place the appliance where it may fall into a bathtub or other water container.
- Do not allow water or other liquids to run into the interior of the appliance, as this could create a fire and/or electrical hazard.
- This appliance is intended for indoor household use and similar applications. Do not use outdoors.
- Do not use the appliance while sleeping or place it near a person who is sleeping.

- Do not use the appliance near petrol, paints, flammable gas ovens or other heating sources.
- The mains cable should not hang down from the surface on which the appliance is placed in order to prevent the appliance from being pulled down.
- To avoid a circuit overload when using this appliance, do not operate another high-wattage appliance on the same electrical circuit.
- Always plug the appliance directly into a wall socket. Avoid using extension leads where possible as they may overheat and cause a risk of fire.
- Do not use this appliance with an external programmer, timer switch or any other device which would switch the appliance on automatically unless this has already been pre-built into the appliance by the manufacturer.
- Do not pull on the power cord. Never move, carry, or hang the appliance by the power cord.
- Do not kink or wrap the power cord and plug around the appliance, as this may cause the insulation to weaken or split, particularly where it enters the appliance.
- Do not operate the appliance with any safety guards removed.
- Do not operate the appliance if there are any signs of damage to the appliance or accessories supplied.
- Do not attempt to repair or adjust any electrical or mechanical elements in the appliance. Doing so may be unsafe and will void your warranty.
- The appliance is only to be used with the power adapter provided. Do not use other chargers or power adapters as this may damage the appliance.

## **BATTERIES**

—  
This product is supplied with 2 x AAA disposable batteries.





**PLEASE READ AND SAVE THESE IMPORTANT SAFETY INSTRUCTIONS.**

**⚠ BATTERY WARNING: KEEP OUT OF REACH OF CHILDREN.**

Choking hazard. Do not swallow. Harmful if swallowed. Swallowing can lead to chemical burns, perforation of soft tissue, and death. Severe burns can occur within 2 hours of ingestion. **If you suspect your child has swallowed a battery seek medical attention immediately.**

- This product only uses a AAA battery. It is not compatible with other battery types.
- Do not allow children to handle batteries.
- If the battery compartment does not close securely, stop using the product and keep it away from children.
- Ensure that the battery is installed with the correct polarity (+ and -).
- Remove exhausted battery promptly.
- Always inspect new batteries before use. Damaged or weak batteries may leak acid. Discontinue use if batteries show signs of leakage, damage, or weakness at any time.
- Ensure the battery compartment is correctly and securely closed after installing the batteries.
- Wash hands after handling batteries.
- Disposable batteries are not rechargeable and must be recycled or disposed of separately from household waste. Always dispose of batteries at an official collection point and according to your local environmental laws and guidelines.

Explanation of symbols displayed on the unit.

	For indoor use only.		Please read instruction manual and retain for future use.
	Equipment complies with the applicable UK safety requirements and regulations.		Equipment complies with the applicable EU safety requirements and regulations.

**SPECIFICATION**

Model No:	PB-F-22W-UK/PB-F-22S-UK
Product Dimensions:	1056 x 255 x 255mm
Net Weight:	5.8kg
Voltage:	24V DC
Power:	36W





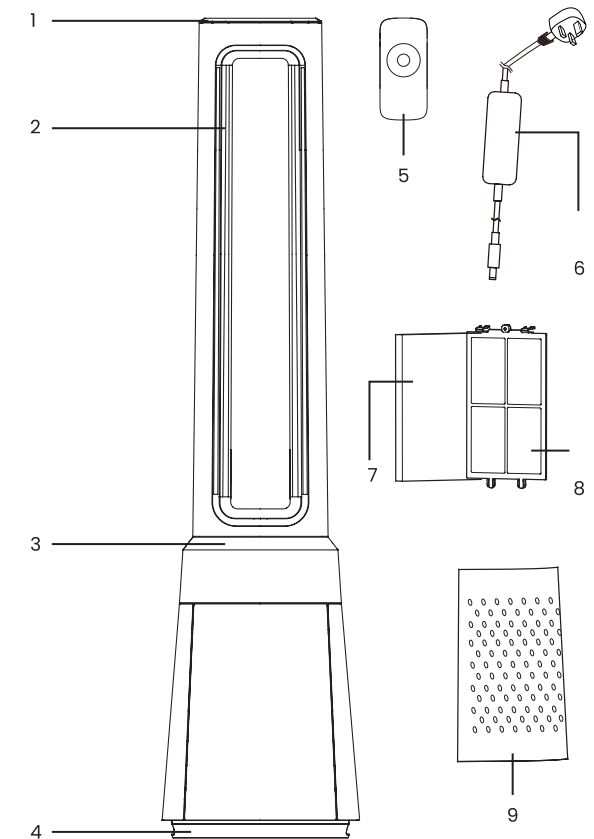

**PARTS**

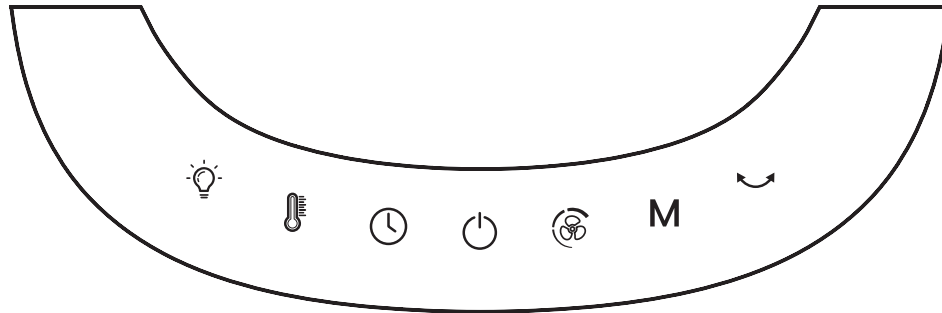
1. Top Cover
2. Air Outlet
3. Display and Control Panel
4. Base
5. Remote Control
6. Adapter
7. 2 x HEPA Filter
8. 2 x Pre-Filter
9. 2 x Air Inlet Grille









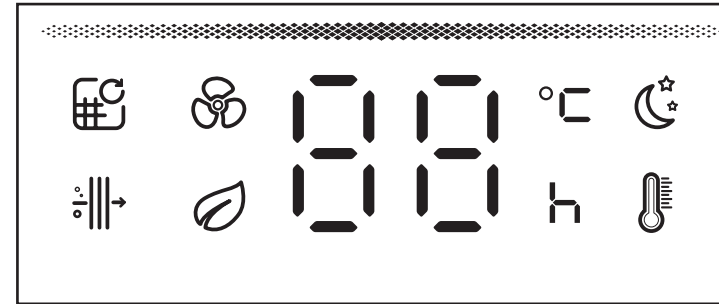

## Control Panel Explained



	Touch this button to turn the air quality light on and off.
	Touch this button to turn on temperature control.
	Touch this button to set a timer from 1-12h.
	Touch this button to turn the unit on/off.
	Touch this button to switch the fan speed or the setting of the eco and sleep modes.
	Touch this button to cycle between the fan's modes: sleep, natural, air purifier and standard wind mode.
	Touch this button to start/stop oscillation.

## Display Panel Explained



	This icon shows the fan is in manual fan mode.
	Filter replacement reminder icon; when the icon stays on, the filter needs to be replaced.
	This icon shows that the fan is in air quality mode.
	This icon shows that the fan is in natural mode.
	This is a display of the wind speed level, timer and displays the temperature in auto mode.
	This icon shows that temperature control is on.
	This icon shows that the fan is in night mode.
	This LED shows the air quality of the room of the fan is in. The colour of the LED will change based on this. <b>Very Good:</b> Blue <b>Good:</b> Green <b>Ok:</b> Yellow <b>Poor:</b> Red

## Remote Control Explained

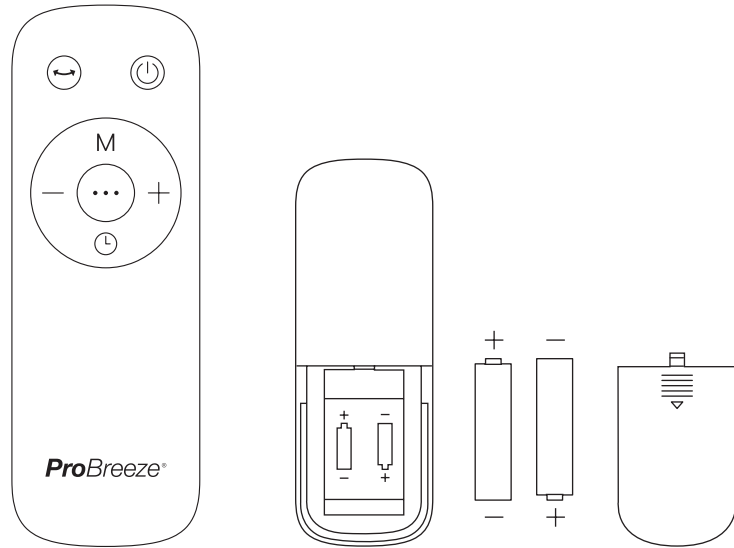

The remote control can be used within five metres from the front of the device. Make sure that the remote-control points to the device.

	Press this button to turn on/off oscillation.
	Press this button to turn the unit on/off.
	Press this to cycle through fan only, night and natural modes.
	Press this button when the unit is on to set a <b>turn-off timer</b> from 1h-7h. Press this button when the unit is <b>off</b> to set a <b>turn-on timer</b> from 1h-7h.
	Press '+' to increase the fan speed. Press '-' to decrease the fan speed.
	Press to activate and deactivate temperature control.

If you find you're missing any parts from your order, please contact our customer care team by emailing [help@probreeze.com](mailto:help@probreeze.com) for fast and friendly help.

## To install the HEPA filters:

1. Remove the air inlet grille.

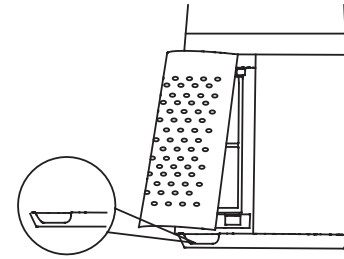

2. Remove the pre-filter by pressing either side of the filter and gently pulling it outwards.

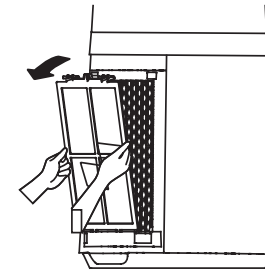

3. Remove the HEPA filter from the protective film.

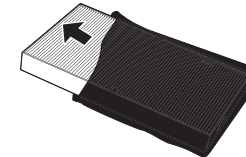

4. Install the HEPA filter ensuring the "FRONT" tabs are facing outwards.

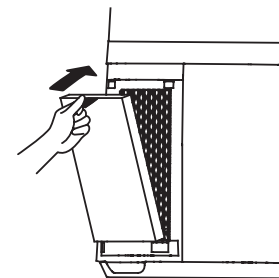

5. Reinstall the pre-filter over the HEPA filter.

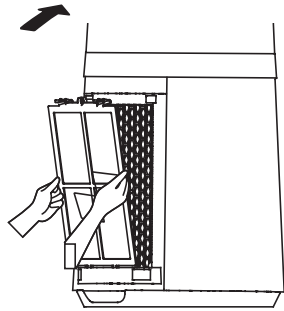

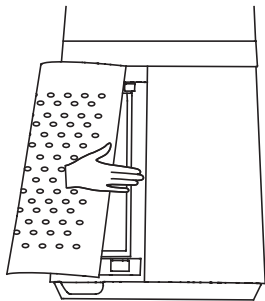

6. Reinstall the air inlet grille.



**To purchase additional filters, please scan the QR code.**  
 If you have any questions or struggle to find the specific filter you need, please contact our customer care team for friendly and efficient help by emailing [help@probreeze.com](mailto:help@probreeze.com).

## OPERATING INSTRUCTIONS

	<b>On/Off</b>	Press On/Off button on the control panel.								
	<b>Fan Speed</b>	To turn the fan speed up or down, either press the fan speed button on the remote or on the control panel. The speed indicator on the led display will change to reflect the speed from 1-10.								
	<b>Modes</b>	<p><b>Modes:</b> To choose your desired mode, either press the mode button on the remote or on the control panel. Pressing this button will cycle through the below modes:</p> <ul style="list-style-type: none"> <li>• <b>Fan mode:</b> In this mode, you can control the fan speed from settings 1-10. To choose your desired fan speed press the fan speed button or the '±' buttons on the remote to adjust.</li> <li>• <b>Natural mode:</b> In this mode, the fan auto-cycles through fan speeds to mimic natural airflow. To choose between two available speed settings press the fan speed button or the '±' buttons on the remote to adjust</li> <li>• <b>Night mode:</b> Night mode slowly reduces the fan speed until it switches to the lowest speed setting to save energy as you sleep. Once activated, the fan speed will function on high speed for 30 minutes and will then reduce to mid speed for 30 minutes and low speed for 30 minutes before switching off. After 60 seconds, the display lights will turn off for an undisturbed rest. To choose between the two available night settings press the fan speed button or the '±' buttons on the remote to adjust.</li> <li>• <b>Air Quality mode:</b> Air Quality mode automatically changes the speed of the fan depending on the air quality of the room. The lower the air quality the higher the fan speed will be.</li> </ul>								
...	<b>Temperature control</b>	<p>In any operating modes, you can activate temperature control which will amend the fan speed to achieve an ambient temperature according to the table below:</p> <table border="1"> <tr> <td>When the room temperature is increasing</td> <td>≥30°C</td> <td>The fan speed level will increase by 2 levels when the room temperature has increased by 1°C.</td> </tr> <tr> <td rowspan="2">When the room temperature is decreasing</td> <td>&lt;30°C</td> <td>The fan speed level will increase by 1 level when the room temperature has increased by 1°C.</td> </tr> <tr> <td>≥31°C</td> <td>The fan speed level will decrease by 2 levels when the room temperature has decreased by 1°C.</td> </tr> </table>	When the room temperature is increasing	≥30°C	The fan speed level will increase by 2 levels when the room temperature has increased by 1°C.	When the room temperature is decreasing	<30°C	The fan speed level will increase by 1 level when the room temperature has increased by 1°C.	≥31°C	The fan speed level will decrease by 2 levels when the room temperature has decreased by 1°C.
When the room temperature is increasing	≥30°C	The fan speed level will increase by 2 levels when the room temperature has increased by 1°C.								
When the room temperature is decreasing	<30°C	The fan speed level will increase by 1 level when the room temperature has increased by 1°C.								
	≥31°C	The fan speed level will decrease by 2 levels when the room temperature has decreased by 1°C.								

		When the room temperature is too high or too low	<31°C	The fan speed level will decrease by 1 level when the room temperature has decreased by 1°C.
			<10°C	The fan speed level is set at Level 1 by default.
			≥40°C	Auto mode will be deactivated by default and will not be automatically resumed when the room temperature drops. (When the auto mode is deactivated, the fan will switch back to natural mode.)
	<b>Timer</b>	You can set your fan to turn off/on automatically in 1-hour increments from 1-12 hours. To set a turn-on timer press the timer button on your remote or control panel when the unit is off (but still plugged into the mains) until the correct time displays on the led display. To set a turn-off timer press the timer button on your remote or control panel when the unit is on until the correct time displays on the led display. To turn this mode off, continue pressing the timer button until there are no lights lit on the timer section of the control panel.		
	<b>Oscillation</b>	Press oscillate button once on your remote or control panel to start or stop fan oscillation. <b>Warning: Please do not manually turn the appliance as this may damage the oscillation mechanics.</b>		

## CLEANING AND STORAGE

**⚠ WARNING: ALWAYS TURN THE APPLIANCE OFF AND UNPLUG THE POWER CORD FROM THE ELECTRICAL OUTLET BEFORE HANDLING OR CLEANING IT.**

**⚠ CAUTION: DO NOT ALLOW WATER OR OTHER LIQUIDS TO RUN INTO THE INTERIOR OF THE APPLIANCE, AS THIS COULD CREATE A FIRE AND/OR ELECTRICAL HAZARD.**

**⚠ CAUTION: DO NOT USE ANY ABRASIVE CLEANERS OR SOLVENTS, AS THIS CAN DAMAGE THE APPLIANCE.**

- Do not attempt to clean the appliance in any other way than that detailed by the manufacturer.
- Clean the exterior surface of the appliance by wiping

it with a soft, damp cloth. Dry the appliance with a soft, clean cloth.



- Clean the vents and openings of the appliance regularly with a vacuum cleaner, using the brush attachment to avoid any dust build-up.
- To extend the lifespan of the filter, a vacuum cleaner, using the brush attachment can be used to remove dust from the surface of the filter.

### Storage:

- Store the appliance in a safe, clean, and dry place, away from direct sunlight and out of reach of children when not in use.
- To store your product, we recommend using the original or a similar-sized box.

## RECYCLING AND DISPOSAL

Waste electrical and electronic products (WEEE), batteries, accumulators and packaging should not be disposed of with general household waste. This is to prevent possible harm to the environment and human well-being, and to help conserve our natural resources. Most electrical products with a plug, battery, or cable can be recycled. Contact your local council, household waste disposal service, or the store where you purchased the product for information regarding the collection schemes in your area.

	<b>Waste Electrical and Electronic Equipment (WEEE)</b>	This symbol on the product and/or packaging indicates that Waste Electrical products (WEEE) under Directive 2012/19/EU which governs used electrical and electronic appliances, should not be disposed of with general household waste.
	<b>Waste Batteries and Rechargeable Batteries</b>	This symbol on the batteries supplied with your product indicates that Waste Batteries under Directive 2006/66/EC which governs used batteries and accumulators should not be disposed of with general household waste. If the battery contains more than 0.004% lead, the battery symbol will be accompanied by the letters (PB).
	<b>The Mobius Loop</b>	This symbol indicates that the product or packaging is capable of being recycled.



### **Take-Back Scheme**

Waste electrical products (WEEE) can be sent to One Retail Group for recycling and disposal when you purchase a new product from One Retail Group, on a like-for-like basis. For more information on how to recycle this product please visit [www.probreeze.com](http://www.probreeze.com)

The end-user of electrical and electronic products (WEEE) is responsible for separating old batteries and lamp bulbs before they are handed over to a designated disposal and recycling service. Waste batteries can also be disposed of in collection bins, which can be found in most local supermarkets and household waste recycling centres.





[www.probreeze.com](http://www.probreeze.com)

One Retail Group, Ryland House,  
24a Ryland Road, Kentish Town, London, NW5 3EH, UK

EU Authorised Representative: Brandrep Limited, The Black Church,  
St Mary's Pl N, Dublin, D07 P4AX, Ireland

© Copyright 2024