

ProBreeze[®]

Instruction Manual

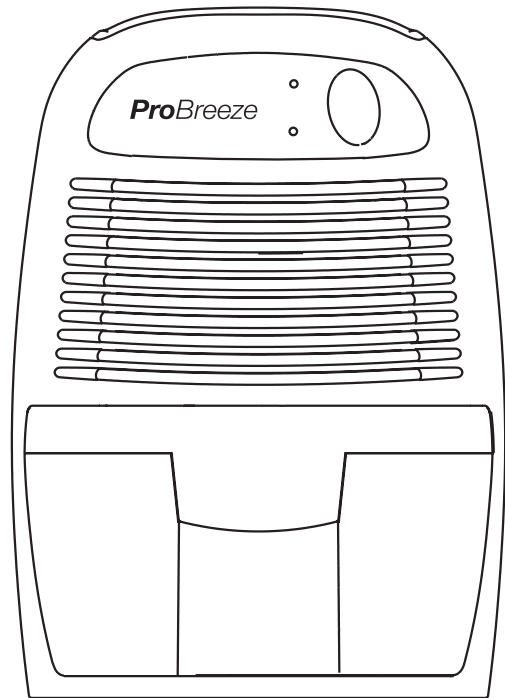

Model PB-02

500ml Mini Dehumidifier

**IMPORTANT INSTRUCTIONS
- RETAIN FOR FUTURE USE**

CONTENTS

EN Safety Instructions.....	Page 3
Symbols Explained	Page 6
Specification	Page 6
Features.....	Page 6
Switching On.....	Page 7
Removing the Water Tank.....	Page 7
Cleaning and Storage.....	Page 7
Recycling and Disposal.....	Page 8

ProBreeze[®]

**500ML MINI DEHUMIDIFIER
MODEL PB-02**

Thank you for choosing to purchase a product from Pro Breeze. Please read the entire manual carefully prior to first use and keep in a safe place for future reference.

SAFETY INSTRUCTIONS

—

PLEASE READ AND SAVE THESE IMPORTANT SAFETY INSTRUCTIONS.

When using electrical appliances, basic safety precautions should always be followed to reduce risk of fire, electric shock, and injury to persons, including the following:

⚠ WARNING: TO AVOID THE RISK OF ELECTRICAL SHOCK, FIRE, OR INJURY TO PEOPLE, ALWAYS TURN THE APPLIANCE OFF, UNPLUG THE POWER CORD FROM THE ELECTRICAL OUTLET AND EMPTY THE WATER TANK BEFORE HANDLING, CLEANING OR SERVICING THE APPLIANCE.

- Do not cover the appliance whilst in use.
- Use this appliance only as described in this manual. Any other use not recommended by the manufacturer may cause fire, electric shock, or injury to person.
- Always unplug the appliance when not in use.
- Do not expose the appliance to direct sunlight, heat sources or extreme cold.
- Keep the appliance out of reach of children and pets.
- Do not leave children alone or unattended in the area where the appliance is in use.
- Children must be supervised not to play with the appliance.
- Cleaning and user maintenance shall not be made by children unless continuously supervised.
- Dispose of water held by the appliance. This water is not drinkable
- The appliance is not to be used by persons (including

children) with reduced physical, sensory or mental capabilities, or lack of experience and knowledge, unless they have been given supervision or instruction.





- When moving the appliance, ensure it is kept in an upright position.
- The appliance must have a minimum 50cm clearance around all sides.
- Never leave the appliance unattended while in use. Always turn the appliance off and disconnected from the power supply when not in use.
- Avoid placing the power cord in areas where it can become a tripping hazard. Do not place the power cord under carpeting or cover it with rugs, runners or similar.
- Place the appliance on a flat, stable and dry surface and always keep the appliance in an upright position. Operating the appliance in any other position could cause a hazard.
- Never place anything on top of the appliance.
- Ensure that the mains supply (including voltage, frequency and power) complies with the rating label of the appliance.
- There may be trace of odour during the first few minutes of initial use. This is normal and will quickly disappear.
- Do not place the appliance against a wall or other appliances.
- Do not cover the appliance or restrict the air flow of the inlet or exhaust grills whilst in use.
- Do not cover, obstruct or push objects into the vents and opening of the appliance as this may cause an electric shock, fire or damage the appliance.
- Do not operate the appliance with wet hands.
- Do not use this appliance near water or in the immediate surroundings of a bath, shower or a swimming pool. Never place the appliance where it may fall into a bathtub or other water container.
- Do not allow water or other liquids to run into the interior

of the appliance, as this could create a fire and/or electrical hazard.

- This appliance is intended for indoor household use and similar applications. Do not use outdoors.
- Do not use the appliance near petrol, paints, flammable gases, ovens, or other heating sources.
- The mains cable should not hang down from the surface on which the appliance is placed in order to prevent the appliance from being pulled down.
- To avoid a circuit overload when using this appliance, do not operate another high-wattage appliance on the same electrical circuit.
- Always plug the appliance directly into a wall socket. Avoid using extension leads where possible as they may overheat and cause a risk of fire.
- Do not use this appliance with an external programmer, timer switch or any other device which would switch the appliance on automatically unless this has already been pre-built into the appliance by the manufacturer.
- Do not pull on the power cord. Never move, carry, or hang the appliance by the power cord.
- Do not kink or wrap the power cord and plug around the appliance, as this may cause the insulation to weaken or split, particularly where it enters the appliance.
- Do not operate the appliance with the water tank removed.
- Ensure the mains cable is fully extended before use and arrange it so that it is not in contact with any part of the appliance.
- Do not operate the appliance with any safety guards removed.
- Do not operate the appliance if there are any signs of damage to the appliance or accessories supplied.
- Do not attempt to repair or adjust any electrical or mechanical elements in the appliance. Doing so may be unsafe and will void your warranty.

- The appliance is only to be used with the power adapter provided. Do not use other chargers or power adapters as this may damage the appliance.
- Do not insert or allow foreign objects to enter any ventilation or exhaust opening as this may cause an electric shock or fire, or damage the appliance.
- Never insert fingers or metal objects into the vents and openings of the appliance.

SYMBOLS EXPLAINED

	For indoor use only.		Please read instruction manual and retain for future use.
	Equipment complies with the applicable UK safety requirements and regulations.		Equipment complies with the applicable EU safety requirements and regulations.

SPECIFICATIONS

- Product dimension: 156 x 130 x 220mm
- Net Weight: 1.04kg
- Operating Capacity: Approx 250ml (9oz) per day at 30°C (86°F), 80%
- Cooling Element: Thermo-Electric Peltier Module
- Fan: 80mm x 80mm Brushless Motor
- Power: DC9V 2.5A
- Max Tank Capacity: 500ml (18oz)

FEATURES

This dehumidifier uses Peltier Technology (no compressor) making it lightweight and quiet. It is perfect for small rooms and poorly ventilated areas such as wardrobes, cabinets and storage rooms that are susceptible to damp odours and fungus. Using this dehumidifier will help eliminate unwanted moisture from the air.

1. On / Off Button
2. 'On' Green LED
3. 'Full' Yellow LED
4. Air Inlet

5. Removable Water Tank
6. Dry Air Outlet
7. Power Connector
8. Rubber Feet
9. Power Adaptor
10. Power Jack
11. Wall Plug
12. Water Displacement Hole
13. Water Tank
14. Hydraulic Cut-Off

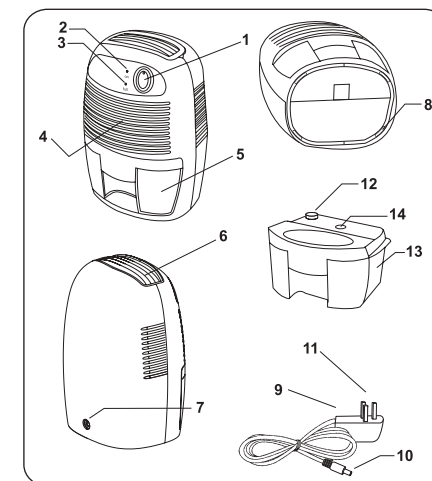

These images are for reference only, please refer to your product. If you find you're missing any parts from your order, please contact our customer care team by emailing help@probreeze.com for fast and friendly help.

SWITCHING ON

1. Remove the power adapter from the box and attach it to both the dehumidifier and main wall socket.
2. Switch the dehumidifier ON using the ON/OFF switch. The green LED will illuminate and you should feel a light breeze blowing out of the dry air outlet.
3. To switch OFF, press the ON/OFF switch again.

REMOVING THE WATER TANK

The dehumidifier can collect up to 250ml (9oz) of water per day and the tank has a maximum capacity of 500ml (18oz). When the tank is full, the LED will turn YELLOW and the unit will turn off. When full, turn OFF the dehumidifier and simply pull the water tank out gently to empty and then carefully slot back in.

CLEANING & STORAGE

⚠ WARNING: ALWAYS TURN THE APPLIANCE OFF, UNPLUG THE POWER CORD FROM THE ELECTRICAL OUTLET BEFORE HANDLING OR CLEANING IT.

⚠ CAUTION: DO NOT ALLOW WATER OR OTHER LIQUIDS TO RUN INTO THE INTERIOR OF THE APPLIANCE, AS THIS COULD CREATE A FIRE AND/OR ELECTRICAL HAZARD.

⚠ CAUTION: DO NOT USE ANY ABRASIVE CLEANERS OR SOLVENTS, AS THIS CAN DAMAGE THE APPLIANCE.

- Do not attempt to clean the appliance in any other way than that detailed by the manufacturer.
- Clean the exterior surface of the appliance by wiping it with a soft, damp cloth. Dry the appliance with a soft, clean cloth.
- Always empty the water tank, clean and dry the appliance when not in use to prevent mould.

Cleaning the water tank:



- Remove and empty the water tank as per the instructions above.
- Clean the water tank with warm tap water and mild detergent (e.g. washing up liquid). **Note:** Do not use boiling water to clean the water tank.
- Ensure to remove any scale or deposits that have formed inside the water tank.
- Wipe all surfaces dry before placing the water tank back into the appliance.

Storage:

- To store your product, we recommend using the original or a similar-sized box.
- Store the appliance in a safe, clean and dry place, away from direct sunlight and out of reach of children when not in use.

RECYCLING AND DISPOSAL

Waste electrical and electronic products (WEEE), batteries, accumulators, and packaging should not be disposed of with general household waste. This is to prevent possible harm to the environment and human well-being, and to help conserve our natural resources. Most electrical products with a plug, battery, or cable can be recycled. Contact your local council, household waste disposal service, or the store where you purchased the product for information regarding the collection schemes in your area.

	Waste Electrical and Electronic Equipment (WEEE)	This symbol on the product and/or packaging indicates that Waste Electrical products (WEEE) under Directive 2012/19/EU which governs used electrical and electronic appliances, should not be disposed of with general household waste.
	The Mobius Loop	This symbol indicates that the product or packaging is capable of being recycled.

Take-Back Scheme

Waste electrical products (WEEE) can be sent to One Retail Group for recycling and disposal when you purchase a new product from One Retail Group, on a like-for-like basis. For more information on how to recycle this product please visit www.probreeze.com

The end-user of electrical and electronic products (WEEE) is responsible for separating old batteries and lamp bulbs before they are handed over to a designated disposal and recycling service. Waste batteries can also be disposed of in collection bins, which can be found in most local supermarkets and household waste recycling centres.



www.probreeze.com

One Retail Group, Ryland House,
24a Ryland Road, London, NW5 3EH, United Kingdom

EU Authorised Representative: Brandrep Limited, The Black Church,
St Mary's Pl N, Dublin, D07 P4AX, Ireland

© Copyright 2023