

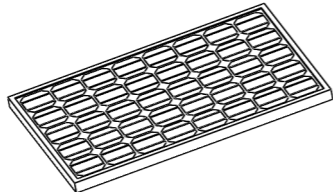

Solarpanel-Aufsteller 28-1

Montageanleitung

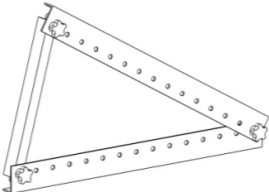

1. Komponenten für die Montage

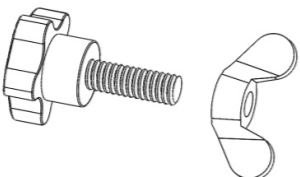
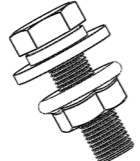
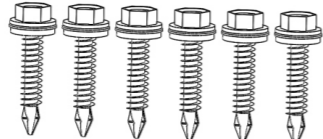
Nr.	Bezeichnung	Bild	Größe in mm	Anzahl
1	Solarpanel bis 150 W (nicht im Lieferumfang)		/	1
2	Montagedreieck bestehend aus den Komponenten 2-1, 2-2 und 2-3		712	2
2-1	Winkelprofil gelocht		712	4
2-2	Winkelprofil		375	2
2-3	M8 Sternschraube mit Flügelmutter		/	6
4	M6x20 Sechskantschraube mit Mutter		M6X20	4
5	ST5.5X38 Bohrschraube		ST5.5X38	6

2. Montagediagramm

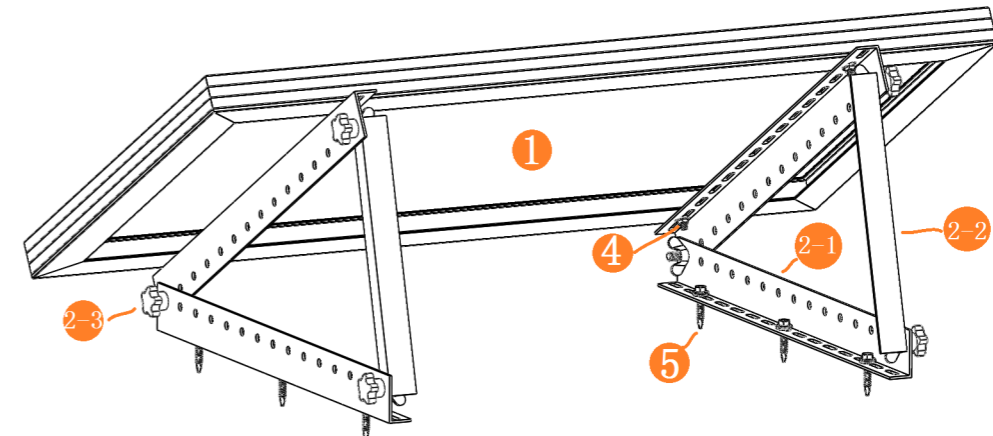

2.1 Montage des Aufstellers

horizontale Montage

oder

vertikale Montage

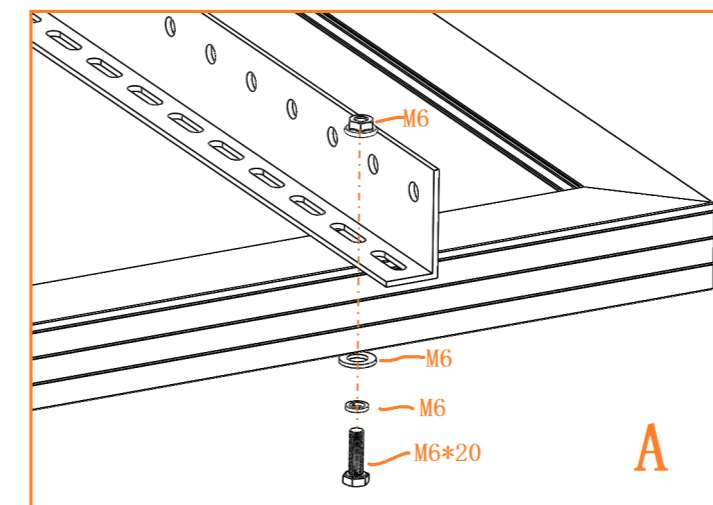
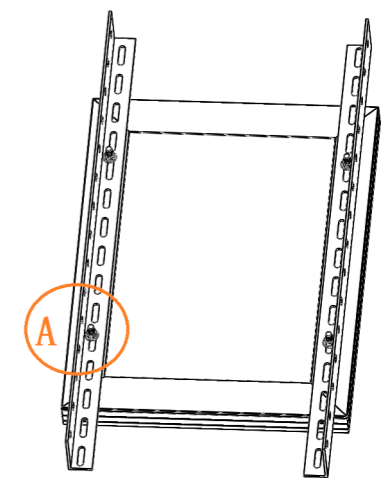
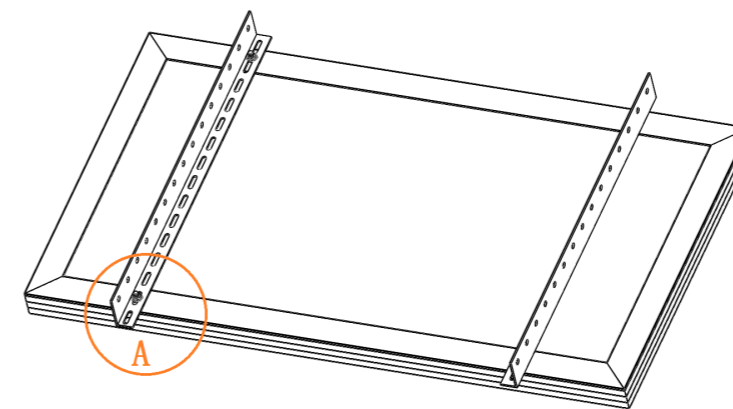

2.2 Bohrschrauben einsetzen

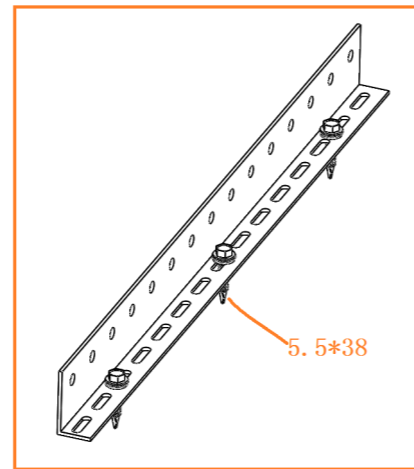
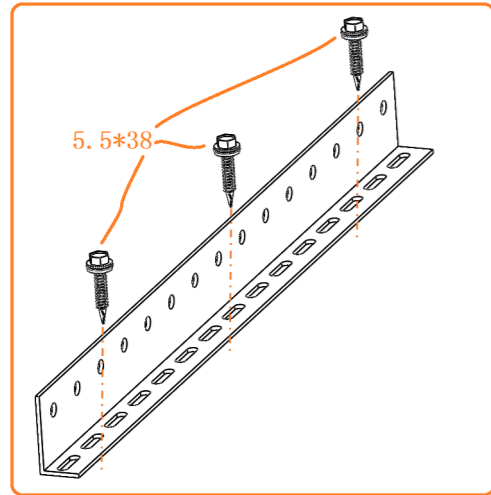

2.3 Sternschrauben befestigen

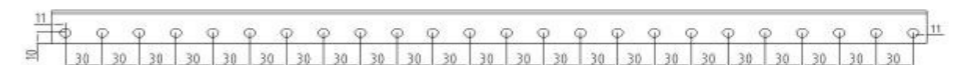
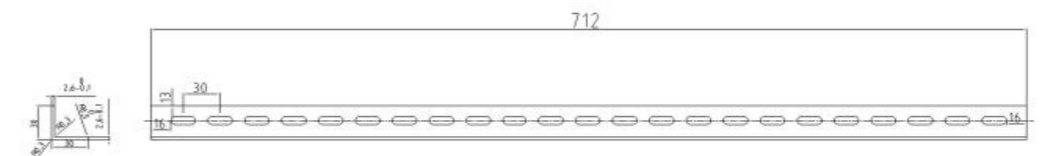
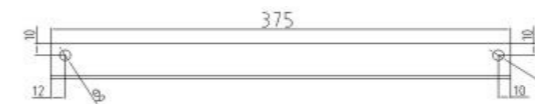
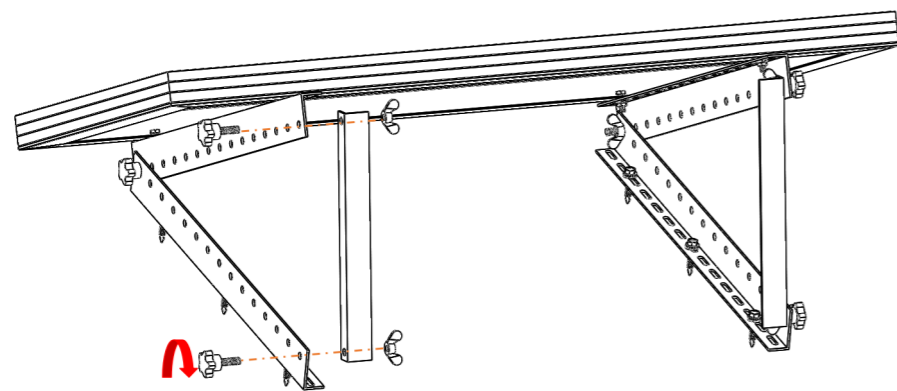
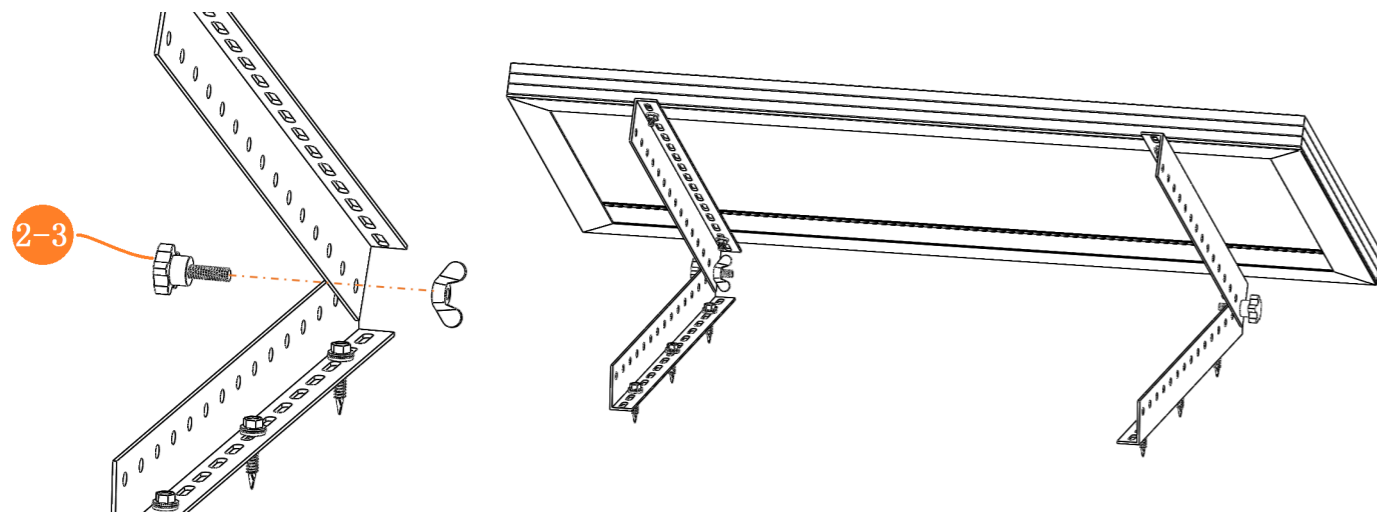

Naassan Com GmbH
Johanniskirchstraße 90
45329 Essen

Bei Fragen erreichen Sie uns unter
E-Mail: kundenservice@avoltik.de
Telefon: 0201-24 33 93 22

AVOLTIK[®]
PHOTOVOLTAIK