

PRODUCT GUIDE

Rycote[®]





Rycote® is a **true pioneer**, delivering reliable, unrivaled, premium quality equipment that is designed to withstand the harshest of environments and rigors of daily use ensuring **capture of consistent and exceptional professional audio**.

For over fifty years, Rycote® has focused on developing and delivering industry standard microphone shock mounting and wind noise protection, from recording and broadcast studios to the extremes of field recording. This is not just our speciality - it is our **passion**.

Rycote® has used their many years of engineering knowledge to **engineer and rigorously test** their complete line of products and innovations to achieve the complex balance of eliminating wind and handling noise, while preserving a microphone's natural frequency response.

The brand has now added a **family of low-self noise microphones** which share Rycote®'s own capsule and preamp design. This platform gives the entire range a complementary tonal quality that makes them easy to 'mix and match' when cutting together.

The microphones come in 5 different polar patterns and cover a wide range of uses for **location sound, ENG, broadcast**, delivering immediate and reliable studio level performance on site.

Rycote® takes enormous pride in each and every product, many of which require several hours of hand assembly by their **trained production team**. The fruits of their craft are seen on movie sets, in sports stadiums and everywhere else around the globe where audio professional solutions are required.

Rycote®, as part of Videndum Media Solutions, have further integrated to provide **additional capabilities and operational excellence**. Rycote® customers will be able to benefit from new product solutions, even greater reliability and vastly wider distribution.

CONTENTS

01 / BASKET SYSTEMS

Stereo Cyclone	08
Cyclone	12
Nano Shield	16
Modular Windshield	18
Super-Shield	20

02 / SLIP-ON SYSTEMS

Super-Softie	24
Classic-Softie	26
Baseball	30
BBG Windshield	32
Mic Foams	34

03 / SHOCK MOUNTS

Boom Shock Mounts	40
Studio Shock Mounts	44
Camera Shock Mount	48

04 / MICROPHONES

Shotgun Mics	54
Pencil Mics	58

05 / LAVALIER SOLUTIONS

Essentials Advanced	66
Essentials Original	68
Lavalier Foams	68
Lavalier Windjammer	69

06 / PORTABLE RECORDER / ON CAMERA

Portable Recorder solutions	72
Mini Windjammer	74
Micro Windjammer	76

07 / ACCESSORIES

Professional Connector System	80
Lyres	82
Microphone Flags	84
Connboxes	85
Cover, Rain Jacket & Cases	86
Handles	90
Perfect For	92
Key Mic Lookup	94



BASKET SYSTEMS

01 /

Iconic, professional all-in-one windshield systems for the best all-round isolation from both wind & handling noise.

Stereo Cyclone

page 08



Cyclone

page 12



Nano Shield

page 16



Modular Windshield

page 18



Super-Shield

page 20



Stereo Cyclone



Performance excellence in every detail

The Rycote Stereo Cyclone range features a comprehensive selection of professional windshield kits, designed for the popular stereo techniques, such as X/Y, Mid-Side and Double Mid-Side, as well as models designed for Single Mic and Ambisonic mic applications.

Each model has been individually designed to perfectly complement specific, popular stereo microphone combinations. Whether it's for production sound, broadcast, audio for gaming or wildlife recording – if you use stereo recording to create directionality, perspective, space, atmosphere and realism – there's a Stereo Cyclone model that's perfect for you!

KEY FEATURES

Superb Acoustic Transparency

Open shell structure design with curved contours and no straight or parallel surfaces – greatly reduces roomtone effects.

From Windshield to Suspension in the blink of an eye

The Windshield basket design uses a magnetic Z-Locking System that can be opened and closed using just one hand. Reassembly allows the windshield sides to snap into perfect alignment.



A sleek new Connbox design - Specific to each stereo configuration

Designed specifically for internal cable routing, isolation and vibration reduction, we took our original Connbox and redesigned it for stereo and multichannel microphone configurations.

Unique design... individually hand-built

Each and every Stereo Cyclone windshield is individually hand-built in our factory in Stroud. This very specialised manufacturing process is carried-out by a highly-skilled Rycote technician, and takes many hours to complete.

One range – Multiple stereo and surround technique

The Stereo Cyclone range covers a variety of popular stereo and surround recording techniques, and each kit is individually designed and optimised for a specific stereo microphone or microphone pairing – our range of models is extensive!

One range – Multiple stereo and surround techniques

The Stereo Cyclone range covers a variety of popular stereo and surround recording techniques, and each kit is individually designed and optimised for a specific stereo microphone or microphone pairing – our range of models is extensive!





Kits and microphone compatibility

Order Code	MS Kit	Mid	Side	Kit
RYC089110	Stereo Cyclone MS Kit 1	Schoeps CCM 4 or 41	Schoeps CCM 8	Small
RYC089111	Stereo Cyclone MS Kit 2	Schoeps MiniCMIT	Schoeps CCM 8	Small
RYC089112	Stereo Cyclone MS Kit 3	Sennheiser MKH 8060	Ambient Emesser	Small
RYC089113	Stereo Cyclone MS Kit 4	Sennheiser MKH 40 or 50	Sennheiser MKH 30	Small
RYC089114	Stereo Cyclone MS Kit 5	Schoeps CMC MK 4 or 41	Schoeps CMC MK 8	Small
RYC089115	Stereo Cyclone MS Kit 6	Neumann KM 140	Neumann KM 120	Small
RYC089116	Stereo Cyclone MS Kit 7	Sanken CS-1	Ambient Emesser	Medium
RYC089117	Stereo Cyclone MS Kit 8	Schoeps CMIT 5	Schoeps CCM 8	Medium
RYC089118	Stereo Cyclone MS Kit 9	Sennheiser MKH 416	Schoeps CCM 8	Medium
RYC089119	Stereo Cyclone MS Kit 10	Sennheiser MKH 416	Ambient Emesser	Medium
RYC089120	Stereo Cyclone MS Kit 11	Sennheiser MKH 416	Sennheiser MKH 30	Medium
RYC089121	Stereo Cyclone MS Kit 12	Sennheiser MKH 60	Sennheiser MKH 30	Large
RYC089122	Stereo Cyclone MS Kit 13	Sennheiser MKH 60	Ambient Emesser	Large
RYC089123	Stereo Cyclone MS Kit 14	DPA 4017c	Ambient Emesser	Small
RYC089124	Stereo Cyclone MS Kit 15	DPA 4018c	Ambient Emesser	Small
RYC089125	Stereo Cyclone MS Kit 16	Sennheiser MKH 8040/8050	Sennheiser MKH 30	Small

Find the Stereo Cyclone Kit that's right for you!

Our online configuration tool makes it easy to find the right Stereo Cyclone kit for you.

Simply visit: <https://rycote.com/microphone-stereo-configurator/>, choose the stereo method you're interested in and select the mics you want to use... we'll show you the right model for you.

Cyclone



Quick. Clear. Consistent.

Cyclone: the premium microphone windshield system with ground-breaking advancements for all-round performance excellence.

The flagship Rycote Cyclone range features next-generation wind and handling noise isolation for discerning audio professionals. Truly evolutionary, this durable windshield system possesses outstanding, consistent performance while being easy to maintain as it does not use fur.

All Cyclone models feature our advanced 3D-TEX® material. This provides a neutral appearance and superior performance over standard basket solutions, with excellent acoustic transparency and superb attenuation of wind-noise.

Covering a lightweight yet durable chassis, Cyclone models are designed to withstand the extremes of the field for reliable, daily use – to deliver the consistent results location audio professionals depend on.

KEY FEATURES

Superb Acoustic Transparency

Open shell structure design with curved contours and no straight or parallel surfaces – greatly reduces roomtone effects.

From Windshield to Suspension in the blink of an eye

The windshield basket design uses a magnetic Z-Locking System that can be opened and closed using just one hand. Reassembly allows the windshield sides to snap into perfect alignment.

Superb Wind Protection

Aerodynamically efficient asymmetric basket covered with our advanced 3D-TEX® material provides enormous benefits in terms of surface turbulence and delivers superb wind-noise reduction.

Taking shock-isolation a step further – Multi Suspension design

The Rycote industry-leading Lyre® microphone suspension reduces the bulk of shock and handling noise, with further shock and handling isolation provided by the Floating Basket Suspension (Pat. Pending). The Lyre principle is also incorporated within the Floating Basket Suspension for vibration isolation between basket and pole.

Consistent performance with low maintenance

Location sound mixers require equipment that will not only withstand extreme conditions, but also maintain consistent performance. 3D-TEX® was developed for both outstanding performance and ease of maintenance.

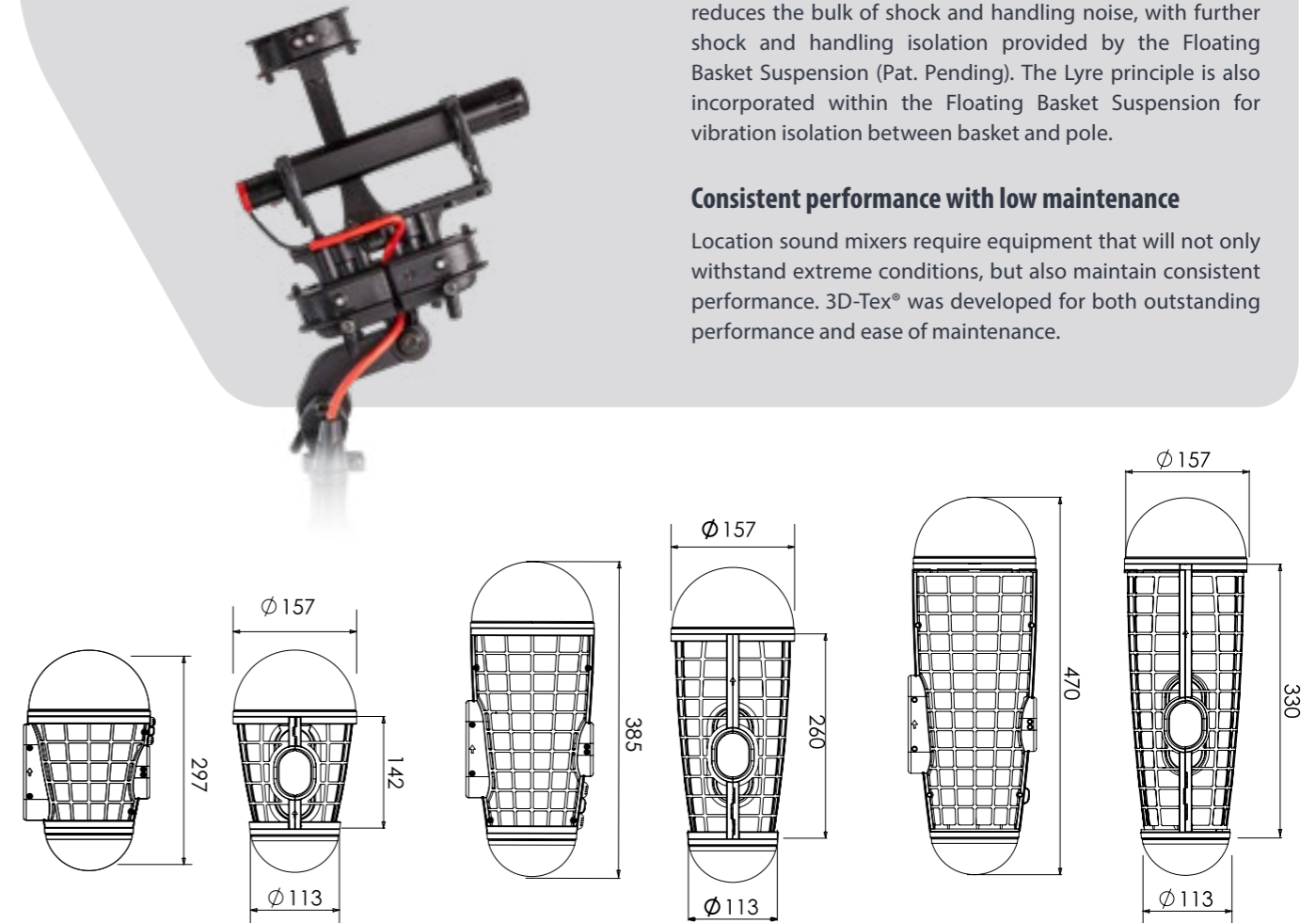

Cyclone Small

Cyclone Small delivers outstanding performance for small diaphragm condenser and short shotgun microphones alike. An Offset Link bracket is included, to provide mic axis articulation if required for ideal microphone placement.

Cyclone Medium

The Cyclone Medium fits a wide range of microphone sizes; it accommodates not only short shotgun microphones, but also many popular shotgun microphones too-all in a compact chassis for maximum wind and handling performance with minimal weight.

Cyclone Large

The Cyclone Large fits with many shotgun microphones. It is made of our durable, grey 3D-TEX® material, maintaining industry-leading performance with a neutral appearance.

Kits and microphone compatibility

Cyclone Windshield Kit, Small (XLR) - RYC089103

DPA: **4017C, 4018C**
 Neumann: **KM 100 series**
 Schoeps: **CMC series, MiniCMIT**
 Sennheiser: **MKH 8040*, MKH 8050*, MKH50**

Input Connector: Reduced XLR-3f

*Our recommendation for the Sennheiser MKH8040/8050 is the Cyclone Small (XLR) model, based on the use of the Sennheiser MZX (XLR module) with these microphones.

Cyclone Windshield Kit, Small (LEMO) - RYC089104

Schoeps: **CCM series**
 Input Connector: Lemo FVN

Cyclone Windshield Kit, Small (MZL) - RYC089105

Sennheiser: **MKH 8060**
 Input Connector: Reduced XLR-3f

Cyclone Windshield Kit, Medium - RYC089102

DPA: **4017B, 4018A**
 Neumann: **KMR 81i, KMR 81D**
 Røde: **NTG-3, NTG-4**
 Sanken: **CS-1, CS-2**
 Schoeps: **CMC w/Cut 1, CMIT 5**
 Sennheiser: **MKH 416, MKH 8060 w/MZF**

Input Connector: Reduced XLR-3f

Cyclone Windshield Kit, Large - RYC089101

Røde: **NTG-2, NTG-4+**
 Sanken: **CS-3e**
 Schoeps: **Super CMIT**
 Sennheiser: **MKH 60**
 Input Connector: Standard XLR-3

Need even more wind protection?

If you are expecting seriously rough weather conditions, add a Cyclone Windjammer® (available separately) for unparalleled levels of ultimate wind protection – as tested in Antarctic blizzards!

Spares and optional accessories

Order Code	Product	Description
RYC029103	Cyclone Windjammer, Small	The smallest Cyclone Windjammer, for use over the Small basket and providing additional wind protection in the harshest conditions.
RYC029102	Cyclone Windjammer, Medium	A medium-sized Cyclone Windjammer, for use over the Medium basket and providing additional wind protection in the harshest conditions.
RYC029101	Cyclone Windjammer, Large	The largest Cyclone Windjammer, for use over the Large basket and providing additional wind protection in the harshest conditions.
RYC019103	Cyclone Windshield Only, Small	A replacement small basket for the Cyclone Windshield Kit, Small.
RYC019102	Cyclone Windshield Only, Medium	A replacement medium basket for the Cyclone Windshield Kit, Medium.
RYC019101	Cyclone Windshield Only, Large	A replacement large basket for the Cyclone Windshield Kit, Large.
RYC042270	Cyclone Pair of Universal Lyre (62-shore)	Replacement Lyre for all Cyclone models. Suitable for smaller, lighter mics like the MKH 8040.
RYC042271	Cyclone Pair of Universal Lyre (72-shore)	Replacement Lyre for all Cyclone models. Suitable for medium-weight mics like the MKH 416.
RYC037301	Extension Handle (Soft grip)	A handy extension handle with a 3/8" M thread for attachment to a range of Rycote shock mounts and suspensions. Features a 3/8" F thread on the underside.
RYC017032	Cyclone Cable, 260mm (MZL)	A spare, MZL to XLR-3M cable for use with the Cyclone Windshield Kit, Small (MZL).
RYC017033	Cyclone Cable, 260mm (LEMO)	A spare, LEMO to XLR-3M cable for use with the Cyclone Windshield Kit, Small (LEMO).
RYC017031	Cyclone Cable, XLR-3M to XLR-3F, 290mm	A long version of the Cyclone cable, for use with long shotgun mics in the Cyclone Windshield Kit, Large.
RYC042277	Cable, XLR-3M to Lightweight 90° XLR-3F, 260mm	A short version of the Cyclone cable, featuring a right-angled XLR-3F connector for weight/space reduction. For use in the Cyclone Windshield Kit, Medium and Small.



Nano Shield



Setting a new standard

Rycote® has pushed our windshield kits to another level with the creation of the Nano Shield. Although the blimp shape may look familiar from afar, a closer look reveals several new design and engineering features that make it our most advanced windshield kit yet. The Nano Shield offers an enhanced level of wind protection paired with improved acoustic transparency.

The kits are smaller and on average weigh 30% lighter than Modular Windshield Kits. The new advanced Lyre® mounts are also more compliant and offer better handling noise reduction. Overall the Nano Shield Kits raise the bar for performance and versatility.

KEY FEATURES

Mix-n-Match Design

The Nano Shield kits use a unique magnetic locking basket design which can be configured to fit various microphone sizes by simply swapping out basket halves. Each size of basket half can interlock with any other size. They also have two manual locking sliders to hold everything secure and noise free. Quickly and easily access mics by simply pulling the halves apart.



Advanced Lyre Mounts

Rycote® has advanced our patented Lyre® mount and redesigned them specifically for the Nano Shield kits. While the basic shape might look similar, the material, thickness, center of gravity and mechanical properties have been engineered to provide a more compliant handling response in the direction the microphone is pointing whilst giving more stability in other directions to prevent mics from 'bottoming-out' or moving side-to-side.



No Tools Required

The Lyre® mounts and mounting bar on the Nano Shield can be adjusted, repositioned or swapped out by loosening / tightening the thumbwheel attached to the bar. Likewise, the swivel arm can be repositioned by loosening the friction braking wheel with interchangeable adaptors for an integrated PCS tip or 3/8" thread.



What's in the box

Nano Shield Kits come complete and ready to use out of the box. The basket design and available layers of shielding allow you to customize the level of wind protection to meet your needs. In addition, the patented mounting bar and Lyre mounts can be repositioned, swapped out and taken apart without the need for any tools.



Kits

Nano Shield Kit NS0-AA - RYCO86300

Nano Shield Kit NS1-BA - RYCO86301

Nano Shield Kit NS2-CA - RYCO86302

Nano Shield Kit NS3-CB - RYCO86303

Nano Shield Kit NS4-DB - RYCO86304

Nano Shield Kit NS5-DC - RYCO86305

Nano Shield Kit NS6-DD - RYCO86306

Modular Windshield



The professional standard

Rycote® windshield / suspension systems are the original, iconic systems used by audio professionals around the world since 1969. Rycote® has applied numerous engineering developments, evolving this system to maintain its status as the professional, industry standard over the past decades.

The Modular Wind-shield System offers various levels of wind protection (use with or without Windjammer® and superb shock isolation. Available as a fully complete, comprehensive kits, Modular components can also be purchased for retro-fitting - to accommodate different length or diameter microphones.

What's in the box

Modular Windshields are available as complete Kits, to accommodate specific microphone lengths and diameters. With a wide range of Kits available, almost any microphone can be accommodated and protected with superb isolation from both wind and handling noise.

- Modular Windshield
- Modular Suspension + Lyre® Technology
- Modular Windjammer®
- Connbox
- Boom Pole Adaptor
- XLR Holder
- Pistol Grip
- Brush for fur maintenance
- Hex Head Key



Order Code	Product	Popular Microphones Compatibility
RYC086017	Modular Windshield WS 9 Kit (no CB)	A compact basket solution for small condenser mics such as the Schoeps CCM range or the Sennheiser MKH 8000 range. Note: Additional Connbox purchase required.
RYC086039	Modular Windshield WS 9 Kit (LEMO)	A compact basket solution for the Schoeps CCM range. Supplied with a Connbox CB 10 (LEMO tail incorporated).
RYC086038	Modular Mono Windshield WS 9 Kit (MZL)	A compact basket solution for the Sennheiser MKH 8000 range. Supplied with a Connbox CB 9 (MZL tail incorporated).
RYC086010	Modular Windshield WS 10 Kit	Basket solution suitable for Sennheiser MKH 8000 series microphones with the MZX XLR module fitted. Also suitable for the Line Audio CM3 and Oktava MK-012.
RYC086004	Modular Windshield WS 1 Kit	Basket solution suitable for small diaphragm condenser microphones to 120mm in length with a 19-25mm diameter and a 3-pin XLR connector. Compatible mics include the Neumann KM 180 series.
RYC086067	Modular Windshield WS 1 Kit (MZL)	Basket solution suitable for the Sennheiser MKH 8060 with its MZX XLR module removed, when compact size is the highest priority.
RYC086003	Modular Windshield WS 2 Kit	Basket solution suitable for small diaphragm condenser microphones from 121mm to 160mm in length with a 19-25mm diameter and a 3-Pin XLR connection. Compatible mics include the Sennheiser MKH 50 and MKH 40.
RYC086050	Modular Windshield WS 2 Kit (MZL)	Basket solution suitable for the Sennheiser MKH 8060 with its MZX XLR module removed, to achieve the performance of a WS 3 in a smaller windshield.
RYC086002	Modular Windshield WS 3 Kit	Basket solution suitable for microphones from 161mm to 210mm in length and between 19-25mm in diameter, with a 3 Pin XLR connector.
RYC086069	Modular Windshield WS 3 Kit (XLR-5F)	Basket solution suitable for stereo microphones from 161mm to 210mm in length and 19-34mm in diameter, with a 5-pin XLR connector. Compatible mics include the Pearl MSH 10 and Sanken CSS-50.
RYC086071	Modular Windshield WS 3 Kit, (30mm, No CB)	Basket solution suitable for the Neumann RSM 191 only, incorporating 30mm round Lyre.
RYC086009	Modular Windshield WS 295 Kit	Basket system suitable for shotgun mics 210mm to 255mm in length and 19-25mm in diameter, with a 3-Pin XLR Connector. Favoured by some as a historical alternative to the Modular 4 for the MKH 416, where a compact size is highest priority. Also suitable for the MKE 600.
RYC086001	Modular Windshield WS 4 Kit	Basket system suitable for shotgun microphones 211mm to 280mm in length / 19-34mm in diameter, with a 3-pin XLR connector. Compatible mics include Sennheiser MKH 416, MKH 60 and Schoeps CMIT 5.
RYC086068	Modular Windshield WS 4 Kit (XLR-5F)	Basket system suitable for stereo microphones 211mm to 280mm in length / 19-34mm in diameter, with a 5-pin XLR connector. Compatible mics include the Røde NT4 and Sennheiser MKH 418.
RYC086005	Modular Windshield WS 5 Kit	Basket system suitable for shotgun microphones 281mm to 350mm in length / 19-34mm in diameter, with a 3-Pin XLR connector. Compatible mics include Sennheiser ME 66 K6 and AKG CK 98 SE300 B.
RYC086013	Modular Windshield WS 5 Kit (XLR-5F)	Basket system suitable for stereo microphones from 281mm to 350mm in length, and 19-25mm in diameter with a 5-pin XLR connector. Ideal for the Sanken CSS 5.
RYC086006	Modular Windshield WS 6 Kit	Basket system suitable for shotgun microphones from 351mm to 400mm in length, and 19-34mm diameter with a 3-pin XLR connector. Compatible mics include the Sennheiser MKH 70 and Audio-Technica AT 8035.
RYC086070	Modular Windshield WS 6 Kit (XLR-5F)	Basket system suitable for stereo microphones from 351mm to 400mm in length, and 19-34mm in diameter with a 5-pin XLR connector. Compatible microphones include the Audio-Technica BP4027.
RYC086007	Modular Windshield WS 7 Kit	Basket system suitable for shotgun microphones from 401mm to 450mm in length, and 19-34mm diameter with a 3-pin XLR connector. Compatible microphones include Sony C74 and Sennheiser ME 67 K6.
RYC086008	Modular Windshield WS 8 Kit	Basket solution suitable for shotgun microphones from 466mm to 540mm in length, and 19-34mm diameter with a 3-pin XLR connector. Compatible mics include Sennheiser MKH 816.
RYC086061	Modular Windshield WS 8J Kit	Basket system suitable for Sennheiser MKH 8070 (fitted with MZX XLR module; no MZF filter).
RYC086058	Modular Windshield WS 11 Kit	Basket system suitable for microphones up to 575mm in length and 19-25mm diameter, with a 3-Pin XLR connector. Compatible mics include the Røde NTG8.

Super-Shield



The fast and simple system for shotgun mic

This complete windshield / shock mount system has a unique 'pod' design for super-fast microphone access and, like the Modular Windshield, offers a choice in the level of wind protection provided (use with or without Windjammer®) and superb shock isolation.

This design integrates the same lightweight, flexible, robust plastic netting and screening material used in the Modular Windshield, for professional performance and reliability.

Using patented Rycote Lyre® technology, the Super-Shield provides your microphone with excellent isolation from shocks and vibrations. The clever suspension design also features 'snap-in/pinch-release' Lyre®, which can be easily set to achieve perfect microphone balance.

KEY FEATURES

Lightweight, Durable and Perfectly Balanced

The Super-Shield basket is made from our lightweight, durable, flexible grey plastic netting with a screening material attached. The shock mounts are easily configurable to achieve superb balance when the microphone is fitted.

Superb isolation

The shock mount with our patented Lyre® technology ensures superb isolation against handling and cable-borne noises.



Fast and Simple

With its clever twist-lock design, the basket 'pods' are very easy to attach and remove from the suspension chassis ring. And with the minimum number of parts overall, Super-Shield is a simple, easy to use system providing super-fast access to your microphone.

Robustness - Built-in

The basket pods connect via a durable chassis ring, which also provides added reinforcement to strengthen the windshield.

Advanced wind protection... with minimal high frequency loss

The Super-Shield Windshield Kit comes supplied with a tailor-made Rycote Windjammer®. Using the Windjammer over the windshield provides superb levels of wind-noise attenuation, but with minimal high frequency loss.

What's in the box

Select from three available kit sizes available to fit your microphone, or retrofit your kit with optional front pods and a Windjammer to adjust to fit a broad range of microphone lengths up to 300mm.

Super-Shield Kits include the following components:

- Super-Shield Suspension Chassis
- Rear Pod
- Front Pod
- Super-Shield Windjammer®
- Pistol Grip
- 45cm XLR-3F/3M Cable x 1
- Brush for fur maintenance



Kits and microphone compatibility

Order Code	Product	Specs	Mic Compatibility
RYC010320	Super-Shield Kit, Small	Suitable for mics 19/25mm, up to 200mm length. Body length: 250mm; overall length: 350mm; diameter: 100mm; net weight: 642 gram.	Oktava: MC-012, MK-012 Sanken: CS-1 Schoeps: CMC series, CMC series + CUTI Sennheiser: ME62 K6, ME64 K6, MKH 8060
RYC010321	Super-Shield Kit, Medium	Suitable for mics 19/25mm, up to 200-250mm length; body length: 300mm; overall length: 400mm; diameter: 100mm; net weight: 662 gram.	Audio-Technica: BP4073; DPA; 4017b, 4017c Neumann: KMR-81i, KMR-81D Røde: NTG-1, NTG-3 Sanken: CS-2 Schoeps: CMIT 5 Sennheiser: MKH 416 Shure: VP82, VP895 Sony: ECM 670, ECM 678
RYC010322	Super-Shield Kit, Large	Suitable for mics 19/25mm, up to 250-300mm length; body length: 350mm; overall length: 450mm; diameter: 100mm; net Weight: 692 gram.	Røde: NTG-2 Sanken: CS-3e Sennheiser: MKE 600

For full list of compatible microphones, see: <https://rycote.com/microphone-windshield-shock-mount/super-shield-kit/>

SLIP-ON SYSTEMS

02/

Quick & efficient – our slip-on systems offer superb, cost-effective wind protection at a moment's notice.

Super-Softie

page 24



Classic-Softie

page 26



Baseball

page 30



BGG Windshield

page 32



Mic Foams

page 34



Super-Softie



Unique design with superior performance

The Super-Softie® represents a completely new approach to the slip-on windshield. Unlike conventional slip-on fur windshields, the Super-Softie® sports a unique aerodynamic shape with specially designed 3D-TEX® material. This introduces a new level of wind performance reduction with unparalleled durability, ease of maintenance and long-term reliability.

The shape & structure of the Super-Softie® improves upon standard slip-on windshield designs. Superb wind attenuation performance, along with improved attenuation with extreme low-frequencies and infrasonic frequencies, protects captured audio where wind noise is at its greatest.

KEY FEATURES

Featuring 3D-TEX®

The Super-Softie® windshield is designed with 3D-TEX®, a very clever material able to yield virtually no polar pattern distortion thanks to its open-cell foam design with no rigid internal chassis. Extremely robust, the Super-Softie will sustain excellent performance for years of dedicated use in challenging environments such as news-gathering.

Ready to go

Breaking news and sporting events rarely wait for inclement weather to pass. The Super-Softie® can be quickly and conveniently squeezed out and shaken dry when rain-soaked, or rinsed when dust-coated without affecting its performance. This unsurpassed flexibility and performance makes the Super-Softie ready to go – wherever you need to be.

Available in 6 sizes

Suitable for microphones from 19mm to 25mm in diameter. This lightweight, cost-effective solution fits a wide range of microphones and is perfect for boom pole mounting and handheld use.



Order Code	Product	Specs	Microphone Compatibility
RYC033205	5cm Super-Softie (19/22) (For mics with slots no further than 5cm from the front of the mic.)	Mic Diameter: 19/22mm Internal bore length: 70mm Overall Length: 150mm Min. Diameter: 70mm Max. Diameter: 100mm Net Weight: 65.2 gram	AKG: C391B, CK 1 451, CK 1 460, CK 61 C460 B, CK 63 C460 B, CK 91 SE300 B, CK 92 SE300 B, CK 93 SE300 B Audio-Technica: AT 4053a, AT 4053b Audix: SCX1C DPA: 4006, 4011, 2011c Neumann: KM 180, KM 180 Series, KM 184, KM 185 Oktava: MC 012 / MK 012 Røde: NT55 Schoeps: CMC Series Sennheiser: ME 40, ME 62 K6, ME 64 K6
RYC033206	5cm Super-Softie (24/25) (For mics with slots no further than 5cm from the front of the mic.)	Mic Diameter: 24/25mm Internal bore length: 70mm Overall Length: 150mm Min. Diameter: 70mm Max. Diameter: 100mm Net Weight: 65.2 gram	BeyerDynamic: MCE 72; Sennheiser: MKH 20, MKH 30, MKH 40, MKH 50.
RYC033201	12cm Super-Softie (19/22) (For mics with slots no further than 12cm from the front of the mic.)	Mic Diameter: 19/22mm Internal bore length: 120mm Overall Length: 180mm Min. Diameter: 70mm Max. Diameter: 100mm Net Weight: 89.0 gram	Audio-Technica: AT 4073a (BP4073), AT 875 (AT875R), AT 877 Deity: V-Mic D3 Pro DPA: 4017b, 4017c Sennheiser: MKH 8060 Sony: ECM 673, ECM 674
RYC033202	15cm Super-Softie (19/22) (For mics with slots no further than 15cm from the front of the mic.)	Mic Diameter: 19/22mm Internal bore length: 150mm Overall Length: 210mm Min. Diameter: 70mm Max. Diameter: 100mm Net Weight: 97 gram	Audio-Technica: AT 835ST, BP4029, AT897 Neumann: KMR 81i, KMR-81D Røde: NTG-1, NTG-2, NTG-4, NTG-4+ Sanken: CS-1, CS-2 Schoeps: CMIT 5, Super CMIT Sennheiser: MKE 600 Shure: VP82, VP89S
RYC033203	18cm Super-Softie (19/22) (For mics with slots no further than 18cm from the front of the mic.)	Mic Diameter: 19/22mm Internal bore length: 180mm Overall Length: 240mm Min. Diameter: 70mm Max. Diameter: 100mm Net Weight: 105 gram	AKG: C 568 EB, CK 68 ULS Beyer Dynamic: MCE 86 N (C) S, MCE 87 vs Deity: S-Mic 2 Røde: NTG-3 Sanken: CS-3e Sennheiser: ME 66 K6, ME 80 K3U, MKH 416, MKH 418 Sony: ECM 670, ECM 678, ECM 680S
RYC033204	18cm Super-Softie (24/25) (For mics with slots no further than 18cm from the front of the mic.)	Mic Diameter: 24/25mm Internal bore length: 180mm Overall Length: 240mm Min. Diameter: 70mm Max. Diameter: 100mm Net Weight: 105 gram	Sennheiser: MKH 60 Sony: ECM 672

Classic-Softie



The original slip-on windshield

The genuine Rycote® Classic-Softie® set the standard for slip-on wind protection, offering proven, cost-effective wind protection at a moment's notice.

Advanced materials, adhesives and assembly techniques all combine to make "the Softie" an extremely tough product that provides excellent wind protection to withstand the harshest environments.

Providing lightning-fast wind protection, the Softie is designed for modern day ENG and location recording. Specially designed acoustic foam and synthetic fur achieve up to 25 dB of wind-noise reduction without any adverse effect on high frequencies.

Classic-Softie Kits

Perfect for boom mounting or hand-held recording, the Classic-Softie® Kit has all the essential components necessary for modern day ENG and location recording. The Classic-Softie® is the simplest, most robust & cost-effective windshield in our range.

The Classic-Softie® Kits include:

- Classic-Softie® Windshield
- InVision® Softie Lyre® Mount with Pistol Grip
- 40cm XLR-3F/3M cable (4.8mm)
- Brush for fur maintenance



Classic-Softie Camera Kits

These essential all-in-one kits provide excellent protection from wind, shock and vibration when capturing audio using shotgun microphones on camera. With its multi-purpose shock mount fitting, this versatile kit also includes all components needed for boom or stand mounting.

Available for various microphone lengths and 19-22mm diameter.

The Classic-Softie® Kits include:

- Classic-Softie® Windshield
- InVision® Video Shock mount
- 10 cm Hot Shoe Extension
- Camera Mic Clamp / Hot Shoe Adaptor
- 3/8" Boom Swivel with Lever
- Hot Shoe 3/8" Adaptor
- 1/4" Adaptor with 19mm washer
- Brush for fur maintenance





Classic-Softie Size	Specs	Classic-Softie	Kit	Camera Kit	Mic Compatibility
5cm Classic-Softie (19/22)	Mic Diameter: 19/22mm Internal Length: 50mm External Length: 75mm Rubber Diameter: 70mm Overall Diameter: 120mm	RYC033012	RYC033312	N/A	AKG: C450, C451, C460B SE300B Audio-Technica: AT 4053A, 4053B Neumann: KM180 Series Oktava: MC012, MK012 Røde: NT55 Schoeps: CMC Series Sennheiser: ME40, ME62, ME64
5cm Classic-Softie (24/25)	Mic Diameter: 24/25 mm Internal Length: 50mm External Length: 75mm Rubber Diameter: 70mm Overall Diameter: 120mm	RYC033013	RYC033313	N/A	BeyerDynamic: MCE72 Sennheiser: MKH 20, 30, 40, 50
7cm Classic-Softie (19/22)	Mic Diameter: 19/22 mm Internal Length: 70mm External Length: 100mm Rubber Diameter: 70mm Overall Diameter: 120mm	RYC033014	N/A	N/A	Deity: V-Mic D3 Sanken: CS-M1 Softie Kit RYC033395 for Sanken CS-M1
10cm Classic-Softie (19/22)	Mic Diameter: 19/22mm Internal Length: 100mm External Length: 125 mm Rubber Diameter: 70mm Overall Diameter: 120mm	RYC033022	N/A	N/A	JVC: DY-500, GY HD 200, MV-P615U Sony: ECM CG1, ECM XM1, HDV Z7, HXR-MC50E, HXR-NX5U & NX5E, PDW 350, PXW-FS7 / 7K, NEX-FS700RH, PXW-X180, PMW-F5/55 Voice Technologies: VT-5000
10cm Classic-Softie (24/25)	Mic Diameter: 24/25mm Internal Length: 100mm External Length: 125 mm Rubber Diameter: 70mm Overall Diameter: 120mm Height: 70mm	RYC033023	N/A	N/A	Canon: XL-1, XL-1S, XL-2 Sony: DNW-7, DNW-790, DNW-9-NSP, DNW-90P, DNW-90SX, DVW-400, DVW600, DVW700P, DVW700WSP, DVW707, DVW709, HD-905P
12cm Classic-Softie (19/22)	Mic Diameter: 19/22 mm Internal Length: 120mm External Length: 145mm Rubber Diameter: 70mm Overall Diameter: 120mm Height: 70mm	RYC033032	RYC033332	RYC116010	Audio-Technica: AT 4073a (BP4073), AT 875 (AT875R), AT 877 DPA: 4017 Schoeps: CMIT 5 Sennheiser: MKH 8060, MZF, MZX, MZL Sony: ECM 673, ECM 674, NEX-FS700RH, PXW-FS7/7K, PXW-X180, PMW-F5/55
12cm Classic-Softie (24/25)	Mic Diameter: 24/25 mm Internal Length: 120mm External Length: 145 mm Rubber Diameter: 70mm Overall Diameter: 120mm	RYC033033	N/A	N/A	Deity: V-Mic D3 Pro Sony: BVP5/BVP7, BVP 537, BVW
15cm Classic-Softie (19/22)	Mic Diameter: 19/22 mm Internal Length: 150mm External Length: 175mm Rubber Diameter: 70mm Overall Diameter: 120mm	RYC033042	RYC033342	RYC116011	Audio-Technica: AT 897 Neumann: KMR 81i, KMR-81D Røde: NTG-1, NTG-2, NTG-4, NTG-4+ Sanken: CS-1, CS-2 Sennheiser: MKE 600 Shure: VP82, VP895
18cm Classic-Softie (19/22)	Mic Diameter: 19/22 mm Internal Length: 180mm External Length: 205 mm Rubber Diameter: 70mm Overall Diameter: 120mm Height: 70mm	RYC033052	RYC033352	RYC116012	AKG: C 568 EB, CK 68 ULS C460B Full + RED Beyer Dynamic: MCE 86 N (C) S, MCE 87vs Deity: S-Mic 2 Røde: NTG-3 Sanken: CS-3e Sennheiser: ME 66 K6, ME 80 K3U, MKH 416, MKH 418 Sony: ECM 670, ECM 678, ECM 6805
18cm Classic-Softie (24/25)	Mic Diameter: 24/25mm Internal Length: 180mm External Length: 205 mm Rubber Diameter: 70mm Overall Diameter: 120mm	RYC033053	RYC033353	N/A	Sennheiser: MKH 60 Sony: ECM 672
24cm Classic-Softie (19/22)	Mic Diameter: 19/22 mm Internal Length: 240mm External Length: 265 mm Rubber Diameter: 70mm Overall Diameter: 120mm	RYC033072	N/A	N/A	AKG: CK 8 451, CK 8 460, CK 98 SE300 B Audio-Technica: AT 835b (AT8035) Azden: SG(M)-2X (Cardioid)
29cm Classic-Softie (19/22)	Mic Diameter: 19/22mm Internal Length: 290mm External Length: 315 mm Rubber Diameter: 70mm Overall Diameter: 120mm	RYC033082	N/A	N/A	Audio-Technica: AT 815ST (BP4027) Azden: SG(M)-2X (Omni) .
29cm Classic-Softie (24/25)	Mic Diameter: 24/25mm Internal Length: 290mm External Length: 315 mm Rubber Diameter: 70mm Overall Diameter: 120mm	RYC033083	N/A	N/A	Sennheiser: MKH 70
32cm Classic-Softie (19/22)	Mic diameter: 19/22mm Internal Length: 320mm External Length: 345 mm Rubber Diameter: 70mm Overall Diameter: 120mm	RYC033092	N/A	N/A	AKG: CK 68 ULS C460B Full; Audio-Technica: AT 815b (AT8015).

Baseball



A whole new ball game!

This ingenious little 3" windscreen has been designed for interior boom pole use, greatly reducing unwanted 'swooshes' during fast swings and other rapid movements.

The Baseball is fitted with a soft yet durable end-cap. Made of thermoplastic elastomer – a unique plastic and rubber mix – the end-cap helps secure the mic and provides an effective seal against wind. The Baseball comes in '19/20', '21/22' (green end-cap) and '24/25' variants, reflecting compatible microphone diameters in mm.

All versions have the same exterior dimensions, but come with different internal bore diameters to fit a variety of industry-standard microphones.

KEY FEATURES

Minimise the 'Swoosh' when booming!

Incredibly lightweight (Just 17g*) and offering significantly increased performance over conventional foam windscreens, the baseball is ideal for fast/deep booming and plosive reduction. It also helps to protect your mic.

- Significantly increased performance versus conventional foam windscreens;
- Provides -30dB of wind noise attenuation, across the frequency spectrum;
- Rapid attachment and removal;
- Durable and easily maintained;
- Offers capsule protection to the mic (during scene 'down-time' and equipment changes);
 - Acoustically transparent open cell foam and soft felt cover construction;
 - Handmade in the UK.

Capture the performance

The Baseball is fantastic for interior boom pole use... but that's not the whole story. The Baseball 21/22 is compatible with some very popular mics used for pro-audio music applications (e.g. the Neumann KM180 series). This Baseball model is a great choice for recording instruments with these mics – partner it with the Baseball Windjammer® to capture the performance in stage/concert environments too.

Go faster

The Baseball Windjammer® is an incredibly useful little add-on product for the Baseball, allowing for even faster/deeper boom swings indoors. Importantly, with the Windjammer fitted, the Baseball can now also be used outdoors in light winds.

The Baseball Windjammer® comes in one size, which fits all our Baseball variants, i.e. 19/20mm, 21/22mm and 24/25mm. Weighing just 15g*, the Baseball Windjammer adds very little extra size or weight when fitted to the Baseball.

Adding a Baseball Windjammer® to the Baseball brings a very useful extra 10dB of wind noise attenuation, across the spectrum. So, the performance of the Baseball with the Windjammer fitted is -40dB wind noise attenuation, across the frequency spectrum.

* Please note that dimensions and weights could be approximate.



Kits and microphone compatibility

Baseball, Black (19/20) Single - RYC039701

Baseball, Black (19/20) 3-Pack - RYC039703

Baseball, Black (19/20) Single & Windjammer - RYC039710

DPA: **4018**

Schoeps: **CMC Series**

Sennheiser: **MKH 8040, MKH 8050***

Baseball, Black (21/22) Single - RYC039705

Baseball, Black (21/22) 3-Pack - RYC039706

Baseball, Black (21/22) Single & Windjammer - RYC039711

Audio-Technica: **AT4049b, AT4051b, AT4053b, AT4021b, AT4022, AT4041**

Neumann: **KM180 Series (KM183, KM184, KM185)**

Sennheiser: **ME64 K6**

Baseball, Black (24/25) Single - RYC039702

Baseball, Black (24/25) 3-Pack - RYC039704

Baseball, Black (24/25) Single & Windjammer - RYC039712

Sennheiser: **MKH 40, MKH 50**

Baseball Windjammer® - RYC055345

Windjammer for use with all Baseball variants, providing additional wind protection for speedy boom swings and facilitating use in light winds outdoors.

*Using MZX 8000 XLR modules.
Remote MZL cables not currently compatible.

BBG Windshield



A full windshield in a small package

Perfect for short microphones, the BBG Windshield is suitable for low-profile boom applications as well as for use in hand-held operations and interviews. Designed to accommodate not only cylindrical microphones, it also accommodates microphones with bulbous windscreens where the maximum head diameter is 80mm. The BBG Windshield is also an excellent solution for ORTF applications.

BBG Windshield

Constructed of the same material as our full-size Modular Windshields, the BBG Windshield is designed to slip directly onto the microphone, and is secured by a grommet that grips the microphone body. It can be separated into two halves to accommodate ball-head and tapered body microphones.



BBG Windjammer

The BBG Windjammer® is the perfect addition to the BBG Windshield, for the highest possible protection against extreme wind noise. This high-quality, synthetic fur-cover originally developed by Rycote®, when used with the BBG, provides up to 50 dB of wind-noise attenuation for excellent audio recordings. Made from materials specially designed for wind-noise isolation, the Windjammer® has virtually no adverse effect on high frequencies.



Kits and microphone compatibility

Order Code	Product	Specs	Popular Compatible Microphones*
RYC011001	20mm BBG Windshield	Windshield Height: 100mm Windshield Length: 100mm Grommet Internal Diameter: 20mm Maximum wind-noise attenuation: 30dB	AKG: C391 B Oktava: MC 012, MK 012 Røde: NT5, NT55 Schoeps: CMC Series DPA: 2011c
RYC011007	21mm BBG Windshield	Windshield Height: 100mm Windshield Length: 100mm Grommet Internal Diameter: 21mm Maximum wind-noise attenuation: 30dB	Audio-Technica: AT 4021, AT 8022 (BP 4025) BeyerDynamic: ME 930 Schoeps: CMC Series (With Cut 1) Audix: SCX1C
RYC011002	22mm BBG Windshield	Windshield Height: 100mm Windshield Length: 100mm Grommet Internal Diameter: 22mm Maximum wind-noise attenuation: 30dB	Neumann: KM 180 Series
RYC011003	25mm BBG Windshield	Windshield Height: 100mm Windshield Length: 100mm Grommet Internal Diameter: 25mm Maximum wind-noise attenuation: 30dB	BeyerDynamic: MCE 72 Sennheiser: MKH 20, MKH 30, MKH 40, MKH 50
RYC021801	BBG Windjammer	Maximum wind-noise attenuation: 20dB	Fits all Mono BBG Windshields.

*For full list of compatible microphones, see <https://rycote.com/microphone-windshield-shock-mount/bbg-windshield>

Mic Foams



Durable, discreet slip-on wind protection

Rycote® Mic Foams are discreet, slip-on foam windshields, designed to protect the microphone head against light wind and 'pop' (plosive) noise. Made of durable, high quality open-cell acoustic foam, these windshields offer up to 20 dB wind noise attenuation, whilst keeping high frequency loss to a minimum.

Engineered exclusively for Rycote®, this high-quality foam also provides excellent resistance against the damaging effects of moisture and UV light.

KEY FEATURES



Extremely resistant

This high-quality foam also provides excellent resistance against the damaging effects of moisture and UV light.

- They are manufactured from reticulated, colour-fast polyester-based 80 PPI foam (pores per inch);
- Provide broadcast quality acoustic transparency & plosive ('pop') attenuation;
- Manufactured in the UK to strict material & dimensional tolerances;
- Flame resistant in accordance with UL 94 HF1;
- Specially treated to slow the deterioration caused by UV light & moisture.

SGM Foams

SGM Foams for shotgun and other cylindrical shaped microphones, provide quick, slip-on light wind protection. Suitable for boom pole and camera-mounted applications, SGM foams provide excellent resistance against the effects of moisture and UV light in outdoor applications.



Reporter Mic Foams

Reporter Mic Foams are discreet, slip-on foam windshields, designed to protect the microphone head against light wind & 'pop' (plosive) noise. As they keep high frequency loss to a minimum, they are also an excellent choice for 'live' music applications.



Large Diaphragm Foams

The Large Diaphragm Mic Foams provide slip-on protection from light-wind and 'pop' (plosive) noise. Designed for use with numerous side address microphones, these are an excellent choice for broadcast and 'live' music applications.



Windjammer for Foams

Our SGM Foams, and Large Diaphragm Foam Windshields are available with a Rycote® Windjammer® for high-wind situations, providing an additional 12 dB wind-noise attenuation.



Kits and microphone compatibility

Product	Single	10 Pack	Specs	Foam & WJ Kit	WJ Only
5cm SGM Foam (19/22)	RYC104406	RYC103106	Fits mics 19 to 22mm in diameter with slots no further than 5cm from the front of the mic. H: 5.9cm W: 5.1cm Weight: 2.7g	RYC055201	RYC055379
5cm SGM Foam (24/25)	RYC104407	RYC103107	Fits mics 24 to 25mm in diameter with slots no further than 5cm from the front of the mic. H: 5.9cm W: 5.1cm Weight: 2.3g	RYC055202	RYC055379
10cm SGM Foam (19/22)	RYC104408	RYC103108	Fits mics 19 to 22mm in diameter with slots no further than 10cm from the front of the mic.	RYC055203	RYC055380
10cm SGM Foam (24/25)	RYC104409	N/A	Fits mics 24 to 25mm in diameter with slots no further than 10cm from the front of the mic.	RYC055204	RYC055380
12cm SGM Foam (19/22)	RYC104410	RYC103110	Fits mics 19 to 22mm in diameter with slots no further than 12cm from the front of the mic. H: 14.5cm W: 4.4cm Weight: 6.3g	RYC055205	RYC055381
12cm SGM Foam (24/25)	RYC104411	N/A	Fits mics 24 to 25mm in diameter with slots no further than 12cm from the front of the mic.	RYC055206	RYC055381
15cm SGM Foam (19/22)	RYC104402	RYC103102	Fits mics 19 to 22mm in diameter with slots no further than 15cm from the front of the mic.	RYC055207	RYC055207
18cm SGM Foam (19/22)	RYC104401	N/A	Fits mics 19 to 22mm in diameter with slots no further than 18cm from the front of the mic.	RYC055208	RYC055383
18cm SGM Foam (24/25)	RYC104413	RYC103113	Fits mics 24 to 25mm in diameter with slots no further than 18cm from the front of the mic.	RYC055209	RYC055383
18cm ME66 SGM Foam	RYC104428	N/A	Fits Sennheiser ME66	RYC055210	RYC055383
45/100 Large Diaphragm Mic Foam	RYC104422	N/A	Fits mics 45mm in diameter with slots no further than 100mm from the front of the mic.	N/A	RYC055428
18/32 SGM Foam Black	RYC104414	N/A	Fits mics 19-22mm in diameter.	N/A	N/A
30/55 Reporter Mic Foam	RYC104403	N/A	Fits mics 35mm in diameter with slots no further than 50mm from the front of the mic.	N/A	RYC055376
35/50 Reporter Mic Foam	RYC104404	N/A	Fits mics 35mm in diameter with slots no further than 55mm from the front of the mic.	N/A	RYC055377
40/55 Reporter Mic Foam	RYC104405	N/A	Fits mics 40mm in diameter with slots no further than 55mm from the front of the mic. H: 7.8cm W: 5.9cm	N/A	RYC055378
Neumann TLM 103 Foam	RYC104423	N/A	Fits the Neumann TLM 103. H: 94cm W: 69cm Weight: 5.5g	N/A	RYC055456
Neumann TLM 102 Foam	RYC104424	N/A	Fits the Neumann TLM 102. H: 8.0cm W: 7.4cm	N/A	N/A



SHOCK MOUNTS

03 /

Rycote® InVision® shock mounts provide unparalleled, industry-leading shock, vibration and handling noise isolation.

Boom Shock Mounts page 40

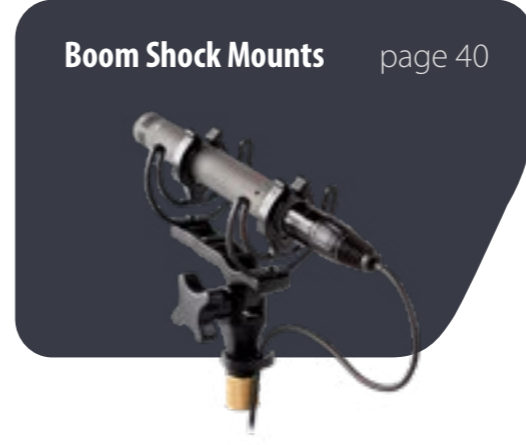

Studio Shock Mounts page 44



Camera Shock Mounts page 48



Boom Shock Mounts



InVision-Industry-leading shock and handling isolation

Rycote® InVision® products are designed for discreet, low-profile boom mounted use in environments where full basket windshielding is not required. InVision® - professional isolation using patented Lyre® suspension systems for industry-leading shock & handling isolation.

InVision Boom Shock Mounts

InVision® shock mounts for Broadcast & Film provide unparalleled protection against shock, vibration, and handling noise for miniature, probe, hand-held, and shotgun microphones. Utilising Rycote® patented Lyre® technology, these virtually unbreakable shock mounts are designed with an integral cable clamp, to isolate the microphone from cable and stand-borne noise.

With several models designed for use with a vast number of microphone makes and models, InVision® shock mounts for Broadcast & Film suspensions provide outstanding shock and handling isolation performance with microphones mounted to boom poles, as well as floor, desk, and suspended stands.

Shock Mounts for Slip-on Windshields

Rycote® has designed the INV-6 HEAVY and INV-7HG MKIII shock mounts for use with slip-on windshields. Ideal for use with Super-Softie®, Classic-Softie and BBG Windshield models, these robust shock mounts provide excellent isolation for boom pole and stand mounting applications.

The INV-7HG MKIII is one of our most popular InVision® Broadcast & Film shock mounts. Suitable for 19-34mm diameter mics, the incorporated Duo-Lyre shock mount has a special 'soft' grip, moulded into the clip. This securely holds the microphone, preventing any slippage or twisting and providing the necessary stability for slip-on windshields and front-heavy microphones.



INV-6 Heavy
RYC041117



INV-7HG
RYC041118

InVision Softie Lyre Mount

Suitable for microphones from 19-34mm in diameter, the InVision® Softie Lyre Mount uses the Lyre® system to provide complete isolation against handling and cable-borne noises. Supplied with a lightweight pistol-grip handle for hand-held applications, this flexible system has a 3/8" thread fitting for boom-pole mounting. With the Duo-Lyre providing support for slip-on windshields - including the Super-Softie®, Classic-Softie, and BBG Windshield - this flexible, robust, cost-effective shock mount is built to excel in modern day ENG and location recording applications.



RYC033702

InVision 'INV-Lite' - Boom Shock Mounts

The INV-Lite has been designed specifically for interior boom use with a foam windscreen. It offers a more focused solution for smaller, lighter shotgun microphones, allows full placement of a 12cm SGM foam to provide basic wind and plosive protection indoors, and provides super-fast access to the microphone via the revolutionary 'cam-lever' clamp system.

KEY FEATURES



INV-Lite 19
RYC041136

- **Elegant. Ergonomic. Balanced.**
- **Designed for shorter, lighter shotgun mics.**
- **Unique design ensures cancellation slots are free.**
- **Patented Lyre® technology with new 'wide' Lyre® design allowing full foam placement.**
- **Balanced and lightweight, perfect for indoor boom work.**
- **Revolutionary cam-lever clamp system.**
- **Robust, reliable Rycote® quality.**
- **Weighs just 115g (without brass screw adaptor).**

Softie-Lite

The Softie-Lite is a slip-on windshield designed to perfectly complement the INV-Lite shock mount, allowing for even faster/deeper boom swings indoors. Softie-Lite provides more plosive and wind protection than a standard foam.



RYC031103

Softie-Lite Kit

The Softie-Lite windshield and the INV-Lite shock mount are also available together, as an all-in-one 'kit', which also includes an XLR cable and holder.

The Softie-Lite Kit include:

- INV-Lite shock mount, fitted with XLR holder on boss;
- Softie-Lite windshield;
- pre-fitted XLR cable (XLR-3M to short right-angled XLR-3F);
- lightweight – just 217g (inc. Softie-Lite).



Softie-Lite Kit 21
RYC031102

InVision Boom Shock Mounts

Order Code	Product	For use on	Description & Microphone Compatibility
RYC041104	INV-4	Stand or boom pole	Suitable for compact condensers. Accommodates windscreen. Compatible mics include the Schoeps CCM series and miniature shotgun mics such as the AKG C747. The 9.5mm Lyre clips feature a 'barrel-style' reducing sleeve which grips the connector and the cable, leaving the body of the microphone free for slip-on solutions such as foams.
RYC041105	INV-5	Stand or boom pole	Suitable for compact and remote capsule condensers. The INV-5 is ideal for compact microphones such as the Schoeps CCM series when used without a large foam windshield. The 62-Shore (19/25) Single Lyre at the front holds a mic body diameter of 19-25mm and the rear, 9.5mm Lyre holds connectors from 8mm to 11mm in diameter (e.g. LEMO).
RYC041106	INV-6	Stand or boom pole	Suitable for short condenser mics (maximum 120mm in length). Compatible mics include Sennheiser MKH 8020/40/50 (when used with their MZX XLR module). The mount features a pair of 72-Shore (19/25) Single Lyre.
RYC041117	INV-6 Heavy	Stand or boom pole	Suitable for short condenser mics (maximum 120mm in length). Supports slip-on windshield. A heavier-grade version of the INV-6, featuring firmer, 82-Shore (19/25) Single Lyre which will support microphones in 'run and gun' scenarios.
RYC041107	INV-7	Stand or boom pole	Suitable for short and medium condenser and short shotgun mics. Ideal for the Schoeps CMC series when used indoors with a foam.
RYC041118	INV-7HG MKIII	Stand or boom pole	Suitable for short and medium condenser and short shotgun mics. Supports slip-on windshield. Ideal for a range of front-heavy microphones, or microphones used with a Softie or BBG windshield.
RYC041108	INV-8	Stand or boom pole	Suitable for 30mm diameter condenser mics. Compatible with the Neumann RSM190/191, Pearl MS8/MSH10 and Sony ECM 999/979/959.
RYC041109	INV-9	Stand or boom pole	Suitable for mics of up to 30mm in diameter, such as the Shure SM57 and SM58, and Neumann KMS105.
RYC041123	InVision BH	Stand or boom pole	Suitable for long shotgun mics, such as the MKH 70 and Neumann KMR 82.
RYC033702	InVision Softie Lyre Mount	Hand held or boom pole	With lightweight Pistol Grip handle; suitable for shotgun mics from 19-34 mm in diameter.

InVision 'INV-Lite' - Boom Shock Mounts

Order Code	Product	For use on	Description & Microphone Compatibility
RYC041136	INV-Lite 19	Stand or boom pole	A balanced, lightweight shock mount for short shotgun mics. Designed specifically for interior boom use with a foam. Super-fast access to the mic facilitated via a unique cam-lever clamp system. Suitable for microphones like the DPA 4017B/C and 4018, the Sanken CS-1e and Sennheiser MKH 8060.
RYC041135	INV-Lite 21	Stand or boom pole	A balanced, lightweight shock mount for short shotgun mics. Designed specifically for interior boom use with a foam. Super-fast access to the mic facilitated via a unique cam-lever clamp system. Suitable for the Schoeps MiniCMIT.
RYC031103	Softie-Lite 19	INV-Lite Mount	Designed to complement the INV-Lite mount, allowing for even faster/deeper boom swings indoors. The Softie-Lite Windshield provides even more plosive and wind protection than a standard foam. Suitable for microphones like the DPA 4017B/C and 4018, the Sanken CS-1e and Sennheiser MKH 8060.
RYC031104	Softie-Lite 21	INV-Lite Mount	Designed to complement the INV-Lite mount, allowing for even faster/deeper boom swings indoors. The Softie-Lite Windshield provides even more plosive and wind protection than a standard foam. Suitable for the Schoeps MiniCMIT.
RYC031101	Softie-Lite Kit 19	Stand or boom pole	Includes INV-Lite and Softie-Lite, as well as a super-low-profile, pre-fitted XLR cable. Suitable for microphones like the DPA 4017B/C and 4018, the Sanken CS-1e and Sennheiser MKH 8060.
RYC031102	Softie-Lite Kit 21	Stand or boom pole	Includes INV-Lite and Softie-Lite, as well as a super-low-profile, pre-fitted XLR cable. Suitable for the Schoeps MiniCMIT.

Studio Shock Mounts



Added versatility for the studio

Rycote patented Lyre® technology is the most advanced shock mount and suspension technology used in field applications today. Rycote has also applied this expertise to develop the InVision® Studio product line - bringing a new level of performance, versatility, value, and durability to studio, 'live' sound, broadcast and installed applications.

This broad range of solutions includes the Universal Studio Mounts ('USM') for side-address, studio condenser microphones and InVision Studio Suspensions for probe, hand-held, miniature and shotgun microphones.

InVision Universal Studio Mount

For side-address microphones

USM - the Universal Studio Mount - is a purpose-built shock mount designed to fit practically any side-address microphone. The unparalleled flexibility of the InVision® USM allows for unprecedented fast setup in studio and 'live' applications. Its unique, adjustable, universal locking system can be quickly adjusted to securely fit a wide range of microphones. With just a handful of models, the InVision® USM range covers a huge range of microphones, of various diameters, with models that provide peak performance for both lighter and heavier side-address mics alike.



KEY FEATURES

Say goodbye to expensive, fragile elastic suspensions

The USM utilises specially designed clips with Rycote® patented Lyre® technology. Made from robust Hytrel thermoplastic, the USM will never sag or need rethreading. This virtually indestructible, innovative design provides an additional 12 dB of isolation, compared to conventional elastic suspensions.

InVision Universal Studio Mount Kits with Pop Filter

Rycote® has advanced our patented Lyre mount and redesigned them specifically for the Nano Shield kits. While the basic shape might look similar, the material, thickness, center of gravity and mechanical properties have been engineered to provide a more compliant handling response in the direction the microphone is pointing whilst giving more stability in other directions to prevent mics from 'bottoming-out' or moving side-to-side.

InVision Studio Suspensions

For miniature, probe, handheld, and shotgun microphones

InVision® Studio Suspensions provide unparalleled protection against shock, vibration, and handling noise for miniature, probe, hand-held, and shotgun microphones. Utilising Rycote® patented Lyre® technology, these shock mounts are virtually unbreakable and effective at any temperature. For additional protection, all models are designed with an integral cable clamp to isolate cable vibration from the microphone.

Additional InVision Studio Solutions

InVision 7 with Pop Filter Kit

InVision® INV-7 suspension combined with Pop Filter. For probe and shotgun mics from 19 to 25mm in diameter. Excellent for voice-over or dialogue replacement applications.



RYC041126

InVision Stereo Pair Kit

Dual InVision® INV-7 HG MKIII shock mounts, configured in the Stereo Pair Kit for mics 19 to 25mm in diameter, up to 300mm long. Spacing adjustable from 40mm to 200mm.



RYC041125

InVision 7-HG MKIII with Table Stand

70mm round, non-slip base, 3/8-inch thread. Includes InVision® INV-7 HG MKIII shock mount, for microphones of up to 250mm in length. Stand also sold separately.



RYC041127

InVision USM - Studio Shock Mounts

Order Code	Product	Specs	Description & Microphone Compatibility
RYC044901	InVision USM	Horizontal use: 500g Vertical use: 750g Mic Diameter: 18-55mm	Universal microphone shock-mount suitable for microphones weighing up to 750g & between 18mm and 55mm in diameter. Compatible with mics such as the Neumann U 87 and Røde NT1 .
RYC045002	InVision USM Studio Kit	Horizontal use: 500g Vertical use: 750g Mic Diameter: 18-55mm	Universal microphone shock-mount and pop shield suitable for microphones weighing up to 750g & between 18mm and 55mm in diameter. Compatible with mics such as the Neumann U 87 and Røde NT1 .
RYC044903	InVision USM-L	Horizontal use: 250g Vertical use: 750g Mic Diameter: 18-55mm	Universal microphone shock-mount optimised for lighter microphones weighing up to 400g (will hold up to 750g in vertical use; horizontal use limited to mics weighing 250g or less) & between 18mm and 55mm in diameter. Compatible with mics such as the Blue Baby Bottle and Neumann U 67 .
RYC045003	InVision USM-L Studio Kit	Horizontal use: 250g Vertical use: 750g Mic Diameter: 18-55mm	Universal microphone shock-mount optimised for lighter microphones weighing up to 400g (will hold up to 750g in vertical use; horizontal use limited to mics weighing 250g or less) & between 18mm and 55mm in diameter. Compatible with mics such as the Blue Baby Bottle and Neumann U 67 .
RYC044912	InVision USM-VB	Horizontal use: 500g Vertical use: 900g Mic Diameter: 55-68mm	Universal microphone shock-mount optimised for heavier and larger microphones, weighing up to 900g & between 55mm and 68mm in diameter. Compatible with mics such as the Blue Kiwi , CAD E350 and SE Electronics Z2200 .
RYC045005	InVision USM-VB Studio Kit	Horizontal use: 500g Vertical use: 900g Mic Diameter: 55-68mm	Universal microphone shock-mount and pop shield optimised for heavier and larger microphones, weighing up to 900g & between 55mm and 68mm in diameter. Compatible with mics such as the Blue Kiwi , CAD E350 and SE Electronics Z2200 .
RYC044918	InVision USM VB-L	Horizontal use: 500g Vertical use: 900g Mic Diameter: 55-68mm	Universal microphone shock-mount and pop shield optimised for lightweight large microphones, weighing up to 450g & between 55mm and 68mm in diameter. Compatible with mics such as the Neumann TLM 107 .
RYC045001	InVision Universal Pop Filter	6" vocal pop shield	An open cell foam pop filter, offering up to 20dB attenuation of pops & thumps with no HF loss. Foams are removable for a clean, hygienic studio. The Universal clamp allows the Pop Filter to fit on virtually any shock-mount.

InVision Studio & Broadcast - Studio Shock Mounts

Order Code	Product	Description & Microphone Compatibility
RYC041101	INV-1	Suitable for compact condensers. Accommodates windscreen. Features a small, 'barrel-style' mic clip. Compatible with the AKG C747 , Audio-Technica ATM350 , Sennheiser ME36 , Schoeps CCM and others.
RYC041102	INV-2	Suitable for compact and remote capsule condensers. Compatible mics include the Røde NT6 and Sennheiser MKH 8000 series (remote) .
RYC041103	INV-3	Suitable for short condensers. Compatible mics include the AKG C430 , Behringer C2 , DPA 4021 and Sennheiser MKH 8000 series with MZX 8000 module attached .
RYC041104	INV-4	Suitable for compact condensers. Accommodates windscreen. Compatible mics include the Schoeps CCM series and miniature shotgun mics such as the AKG C747 . The 9.5mm Lyre clips feature a 'barrel-style' reducing sleeve which grips the connector and the cable, leaving the body of the microphone free for slip-on solutions such as foams.
RYC041105	INV-5	Suitable for compact and remote capsule condensers. The INV-5 is ideal for compact microphones such as the Schoeps CCM series when used without a large foam windshield. The 62-Shore (19/25) Single Lyre at the front holds a mic body diameter of 19-25mm and the rear, 9.5mm Lyre holds connectors from 8mm to 11mm in diameter (e.g. LEMO).
RYC041106	INV-6	Suitable for short condenser mics (maximum 120mm in length). Compatible mics include Sennheiser MKH 8020/40/50 (when used with their MZX XLR module) . The mount features a pair of 72-Shore (19/25) Single Lyre.
RYC041117	INV-6 Heavy	Suitable for short condenser mics (maximum 120mm in length). Supports slip-on windshield. A heavier-grade version of the INV-6, featuring firmer, 82-Shore (19/25) Single Lyre which will support microphones in 'run and gun' scenarios.
RYC041107	INV-7	Suitable for short and medium condenser and short shotgun mics. Ideal for the Schoeps CMC series when used indoors with a foam .
RYC041118	INV-7HG MKIII	Suitable for short and medium condenser and short shotgun mics. Supports slip-on windshield. Ideal for a range of front-heavy microphones, or microphones used with a Softie or BBG Windshield.
RYC041108	INV-8	Suitable for 30mm diameter condenser mics. Compatible with the Neumann RSM190/191 , Pearl MS8/MSH10 and Sony ECM 999/979/959 .
RYC041109	INV-9	Suitable for mics of up to 30mm in diameter, such as the Shure SM57 and SM58 , and Neumann KMS105 .
RYC041123	InVision BH	Suitable for long shotgun mics, such as the MKH 70 and Neumann KMR 82 .
RYC041126	INV-7 + Pop Filter Kit	InVision INV-7 Pop Filter Kit is a combined suspension/pop filter kit for high-quality shotgun microphones up to 250mm in length.
RYC041125	InVision Stereo Pair Kit	Suitable for short and medium condenser and short shotgun mics such as the MKH 50 and 20 .
RYC041127	InVision 7-HG MKIII with Table Stand	An INV-7 HG MKIII with a stand for a table. Ideal for applications using a range of short shotgun mics and short-/medium-sized condensers.
RYC041128	Table Stand	A table stand for attachment to a range of studio and broadcast shock mounts.

Camera Shock Mounts



Shock & handling noise protection for camera-mounted microphones

Using Rycote® patented Lyre® technology these shock mounts bring professional level shock and handling noise protection to external camera-mounted microphones. For videographers, HDSLR and hand-held camcorder users who are serious about capturing great audio, these shock mounts provide incredible shock & handling noise protection, when using external camera-mounted microphones between 19 and 25 mm in diameter, and up to 300 mm in length.

KEY FEATURE



Duo-Lyre shock mount

All of these InVision® microphone suspensions for camera mounting utilise the Duo-Lyre shock mount. Also available on the INV-7 HG Mk III stand and boom pole mounting, the Duo-Lyre is designed to hold the microphone towards the back while supporting the majority of the weight at the front to accommodate slip-on wind protection such as the Classic-Softie, Super Softie®, and BBG Windshields.

InVision Video Hot Shoe Mount

Designed specifically for mounting to a camera or camcorder hot shoe, this Duo-Lyre shock mount provides excellent protection from camera motor and drive noise, and vibrations, and is a substantial improvement over traditional on-camera microphone mounts. Professional isolation is provided by the Duo-Lyre suspension, which is attached to a mounting bar for secure attachment into the slot of the hot shoe mount on top of the camera. The mount can be rotated through 360 degrees around the camera shoe, for flexibility and ease of use. The additional height of the mount also allows for the microphone and windscreen to be held up and behind the lens, to keep it out of shot.



RYC042901

InVision® Video 1/4" Adaptor

Designed for mounting to the 1/4" thread found on top of many cameras, this lightweight, durable clamp-style shock mount securely holds the microphone in place. Accommodating microphones between 19-25 mm in diameter, the clip is attached to the durable Duo-Lyre shock mount to provide industry-leading handling noise isolation while protecting the microphone from vibration and noise caused by the camera motor and drive. Additional isolation is provided with a flexible cable clamp, to help prevent cable-borne noise.



RYC042902

InVision Softie Lyre Mount CCA

The Softie Lyre Mount with Camera Clamp Adaptor (CCA) attaches onto many professional Sony or Canon cameras with on-board 25-27mm diameter mic holders. The CCA adaptor fits securely into the mic holder, with no twisting or slipping. The Duo-Lyre shock mount clip accommodates 19–25mm diameter microphones, and is attached to the Lyre® suspension providing professional isolation from vibrations and handling noise. The position of the CCA when fitted, lifts the microphone up and backwards and therefore keeps the microphone and slip-on windscreen out of shot – even on wide shots. Extra flexibility is added with an integrated brass 3/8" thread for boom pole attachment.



RYC037306

InVision Softie Lyre Mount MHR

The Softie Lyre Mount Mic Holder Replacement (MHR) replaces built-in or accessory microphone clips with the Duo-Lyre shock mount, to provide professional isolation for externally-mounted microphones. As standard camcorder-mounted mic clips intended for external mics are susceptible to camera and cable generated vibration & handling noise, the InVision Softie Lyre Mount MHR replaces standard shock mounts to provide professional isolation from camera vibration, shock & cable-borne noise. Supplied with three sets of metric screws, this upgrade shock mount can be directly connected to many common camcorders.



RYC037324

Order Code	Product	Compatible Cameras
RYC042901	InVision Video Hot Shoe	Suitable for cameras with a hot shoe. Features a Duo-Lyre mic clip, accommodating shotgun mics with a diameter of between 19 and 25mm. Maximum mic length: 300mm.
RYC042902	InVision Video 1/4" Adaptor	Suitable for cameras with a 1/4" female thread. Features a Duo-Lyre mic clip, accommodating shotgun mics with a diameter of between 19 and 25mm. Maximum mic length: 300mm.
RYC037306	InVision Softie Lyre Mount CCA	The Softie Lyre Mount with Camera Clamp Adaptor (CCA) allows you to attach a shotgun or rifle microphone to camcorders fitted with a microphone clamp (25 to 27mm diameter) or a boom pole with 3/8" thread. Suitable for shotgun microphones 19-25mm in diameter.
RYC037324	InVision Softie Lyre Mount MHR	The Softie Lyre Mount with MHR replaces built-in or accessory camera mounts or clamps, and is supplied with three sets of metric screws (20mm-long M2.5, M3 and M4 types), allowing the mount to be connected directly to many common camcorders such as the Panasonic DVX-series, Sony NXCAM, DSR, HVR, PMW and HDR-series, and many Canon X-series models.





MICROPHONES

04/

Shotgun Mics

page 54



Pencil Mics

page 58



Shotgun Mics



Precise audio with one of the industry's lowest levels of self-noise

Hypercardioid shotgun microphones designed to reproduce an accurate reflection of what is being recorded, offering a crisp sound with some additional warmth, on live broadcast, sound design, TV, cinema and field recording.

KEY FEATURES

- Tested against digital wireless systems and walkie talkies
- Preamp made from non-corrosive machined brass
- Capsule/Interference tube made from lightweight machined aluminium
- Compact design
- Sophisticated RF shielding
- Low power consumption
- Gold-plated Neutrik XLR connector
- Ultra low noise circuitry

HC-15 Short Shotgun Microphone

The Rycote® HC-15 is a hypercardioid short shotgun microphone designed for a wide range of applications in cinema, TV, ENG, live broadcast, sound design studio and field recording. The HC-15 combines a moderately directional polar pattern with extremely low selfnoise. This provides some level of off-axis rejection and isolation with a precise sound quality to match, making the HC-15 a great all around mic for many recording environments.



Specifications

- Length **155mm**
- Frequency Range **50 Hz – 20 kHz**
- Self Noise **8.5 dBA (±2dB)**
- Polar Pattern **Hypercardioid**
- Capsule Type **Back Electret Condenser**
- Output Sensitivity **45.0 mV/Pa (-32.7 dB)**
- Signal / Noise Ratio **85 dB typical (@ 1 kHz/Pa A-weighted)**
- Powering **P-48**
- Max. SPL **133 dB SPL (@ 1 kHz 1.0% THD typical)**
- Connector **XLR-3M**
- Weight **90 g**
- Colour **Black with Red Accent**

Polar response

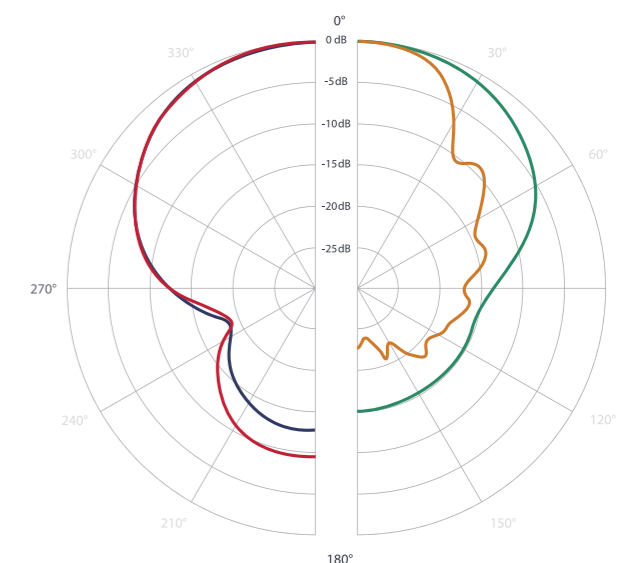

Frequency response

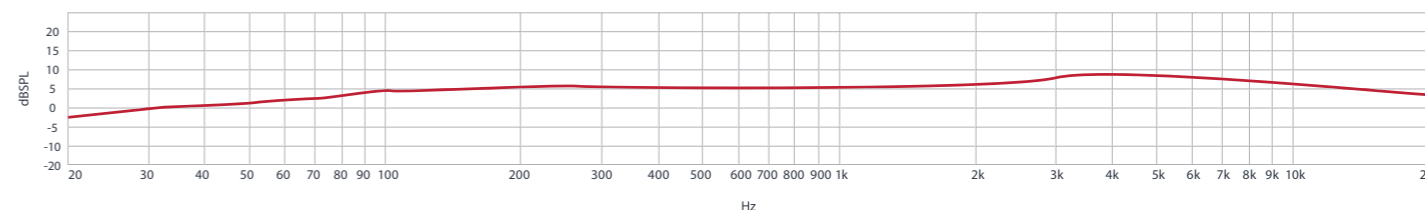

HC-22 Short Shotgun Microphone

The Rycote® HC-22 is a hypercardioid shotgun microphone designed for a wide range of applications in cinema, TV, ENG, live broadcast, sound design, studio and field recording. The HC-22 combines a highly directional polar pattern with extremely low self-noise. This provides solid off-axis rejection and isolation with a precise sound quality to match, making the HC-22 a great all around mic for recording environments which may require a more focused recording approach.



RYC079002

Specifications

- Length **220mm**
- Frequency Range **50 Hz – 20 kHz**
- Self Noise **8.5 dBA (±2dB)**
- Polar Pattern **Hypercardioid**
- Capsule Type **Back Electret Condenser**
- Output Sensitivity **45.0 mV/Pa (-32.7 dB)**
- Signal / Noise Ratio **85 dB typical (@ 1 kHz/Pa A-weighted)**
- Powering **P-48**
- Max. SPL **133 dB SPL (@ 1 kHz 1.0% THD typical)**
- Connector **XLR-3M**
- Weight **100 g**
- Colour **Black with Red Accent**

Polar response

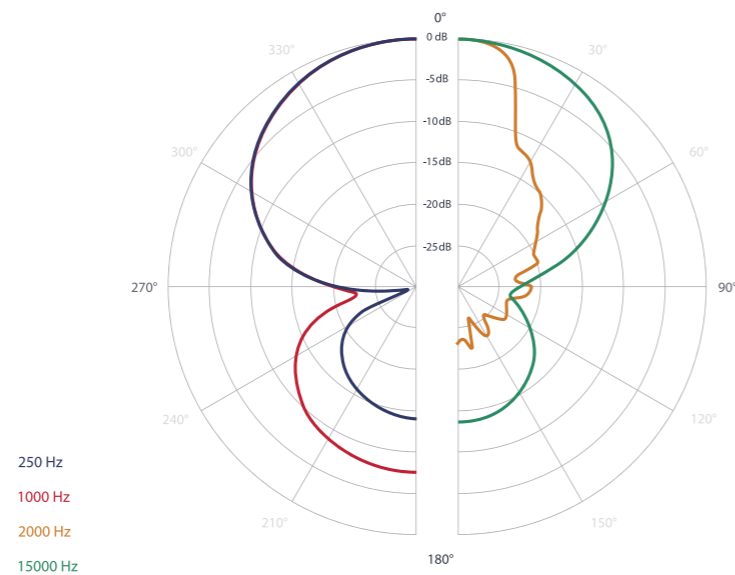

Frequency response

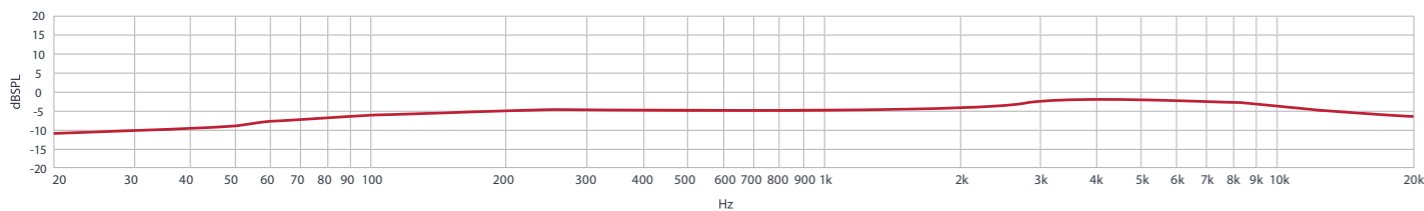

HC-35 Short Shotgun Microphone

The Rycote® HC-35 is a hyper-cardioid, long shotgun microphone, designed for specific applications such as sport broadcast and location recording. The HC-35 produces a highly directional polar pattern utilising a longer interference tube than its siblings, the HC-15 and HC-22, providing better off-axis rejection. Based around our signature low self-noise capsule it delivers the precision and quality that our range of microphones has become renowned for.



RYC079010

Specifications

- Length **352mm**
- Frequency Range **25 Hz – 18 kHz**
- Self Noise **7.5 dBA (±2dB)**
- Polar Pattern **Hypercardioid**
- Capsule Type **Back Electret Condenser**
- Output Sensitivity **55.0 mV/Pa (-32.7 dB)**
- Signal / Noise Ratio **87 dB typical (@ 1 kHz/Pa A-weighted)**
- Powering **P-48**
- Max. SPL **133 dB SPL (@ 1 kHz 1.0% THD typical)**
- Connector **XLR-3M**
- Weight **119 g**
- Colour **Black with Red Accent**

Polar response

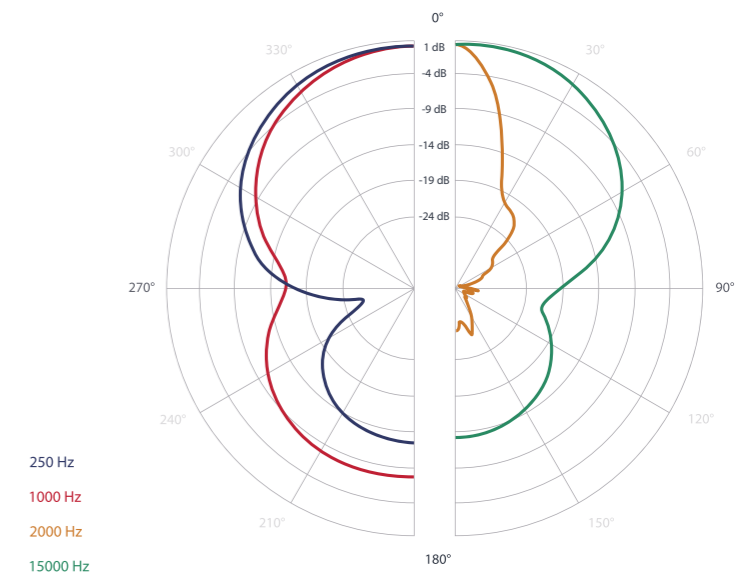

Frequency response

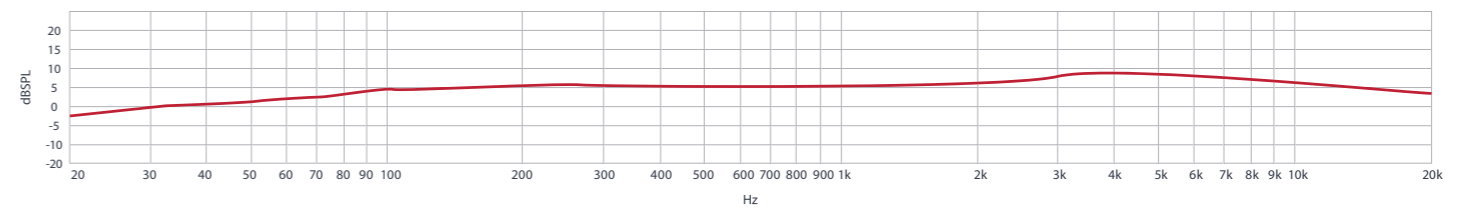

Pencil Mics



Premium performance with a common tonal quality

A range of compact pencil condenser microphones, offering supercardioid, cardioid, omnidirectional and Figure-of-Eight polar patterns which provide a similar tonal quality across Rycote's entire range of microphones.

KEY FEATURES

- Bidirectional condenser microphone
- Ultra-low noise circuitry
- High rejection of lateral sounds
- Consistent acoustic timbre with other Rycote® mics
- Sophisticated RF shielding
- Low power consumption
- Gold-plated Neutrik XLR connections
- Preamp made from non-corrosive
- Tested against digital wireless systems and walkie talkies
- Machined brass preamp case
- Aluminium Interference tube
- Non reflective finish

BD-10 Bi Directional Microphone

The Rycote® BD-10 is a Bi-directional (Figure of 8) condenser Microphone designed mainly for M/S stereo and ambient recording as well as dual dialogue. Perfect for use with the SC-08, CA-08 or HC-15 for a complete Rycote M/S Stereo or DM/S stereo solutions. Based around our signature low self-noise capsule, it delivers the precision and quality that our range of microphones has become renowned for. Designed with same components it blends seamlessly into the existing family with the same tonal quality and attention to detail expected from the Rycote® microphone range.

Specifications

- Length **100mm**
- Frequency Range **40 Hz – 18 kHz**
- Self Noise **18.0 dBA (±2dB)**
- Polar Pattern **Bi Directional**
- Capsule Type **Back Electret Condenser**
- Output Sensitivity **14.2 mV/Pa (-32.7 dB)**
- Signal / Noise Ratio **78 dB typical (@ 1 kHz/Pa A-weighted)**
- Powering **P-48**
- Max. SPL **135 dB SPL (@ 1 kHz 1.0% THD typical)**
- Connector **XLR-3M**
- Weight **84 g**
- Colour **Black with Red Accent**

Polar response

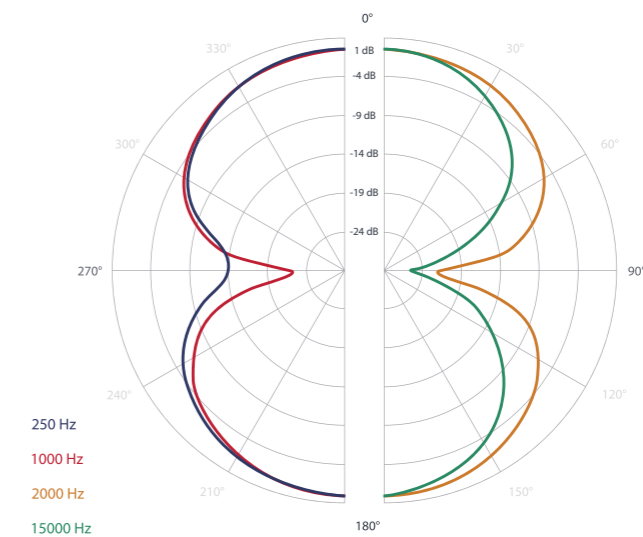

RYC079010

Frequency response

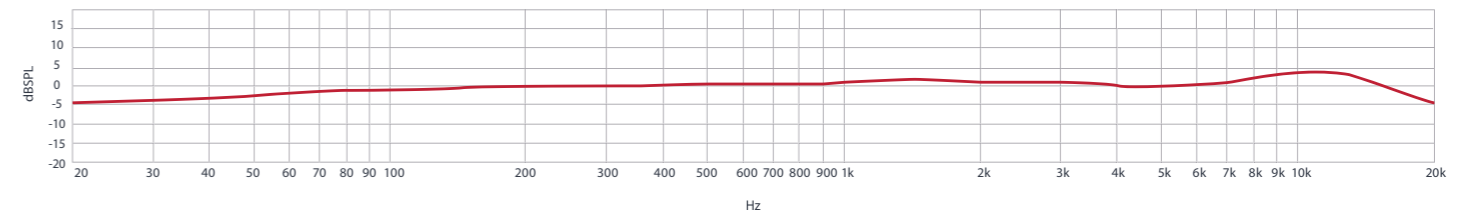

CA-08 Cardioid Condenser Microphone

The Rycote® CA-08 is a cardioid pencil condenser microphone designed for a range of applications in studio and field recording. The CA-08 microphones provide slight directionality with a virtually flat frequency response from 70Hz-20KHz, gradually dropping off below 60Hz. The mics are built on Rycote's low self-noise preamp design and capsules which offer a consistent sonic signature that mixes well when cut together with other Rycote® microphones in the range. The CA-08 mics can be used individually or in matched stereo pairs.

Specifications

Length 78mm	Powering P-48
Frequency Range 45 Hz – 20 kHz	Max. SPL 133 dB SPL (@ 1 kHz 1.0% THD typical)
Self Noise 13.0 dBA (±2dB)	Connector XLR-3M
Polar Pattern Cardioid	Weight 69g
Capsule Type Back Electret Condenser	Colour Black with Red Accent
Output Sensitivity 24.3 mV/Pa (-32.7 dB)	
Signal / Noise Ratio 81 dB typical (@ 1 kHz/Pa A-weighted)	



RYC079003

Polar response

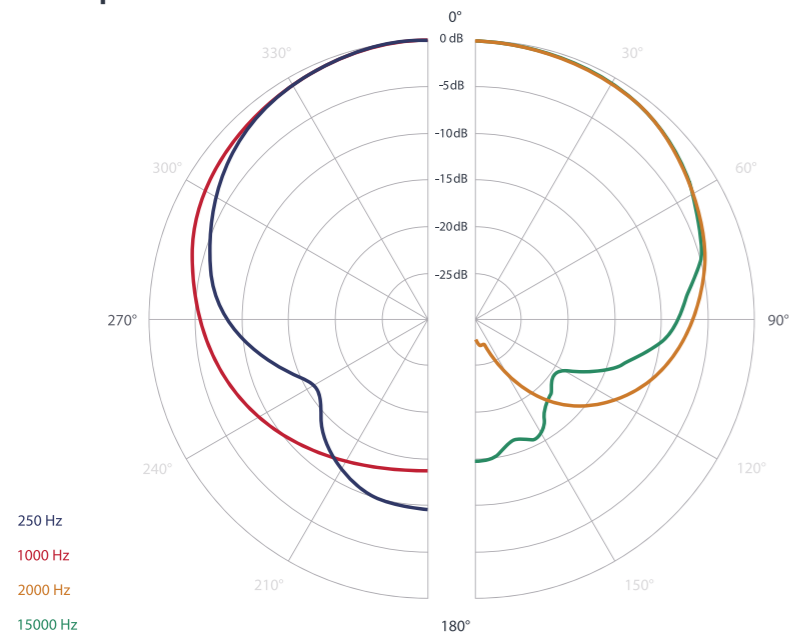

Frequency response

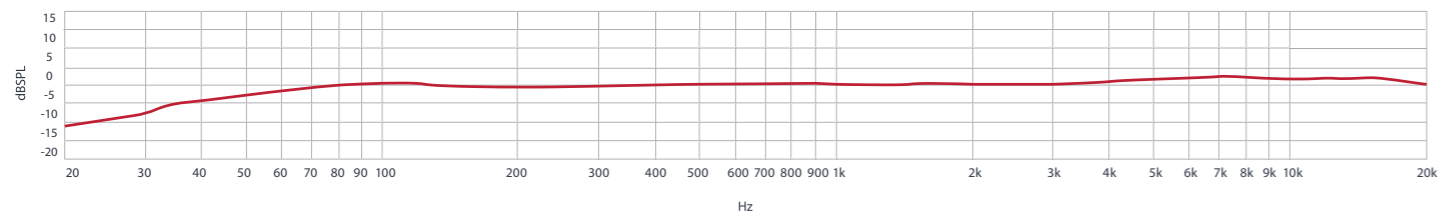

SC-08 Supercardioid Microphone

The Rycote® SC-08 is a supercardioid pencil condenser microphone designed for a range of applications in studio and field recording. The SC-08 microphones provide directionality with a virtually flat frequency response from 70Hz-20KHz, moderately dropping off below 60Hz. The mics are built on Rycote's low self-noise preamp design and capsules which offer a consistent sonic signature that mixes well when cut together with other Rycote® microphones in the range. The SC-08 mics can be used individually or in matched stereo pairs.

Specifications

Length 78mm	Powering P-48
Frequency Range 60 Hz – 20 kHz	Max. SPL 133 dB SPL (@ 1 kHz 1.0% THD typical)
Self Noise 11.0 dBA (±2dB)	Connector XLR-3M
Polar Pattern Supercardioid	Weight 69 g
Capsule Type Back Electret Condenser	Colour Black with Red Accent
Output Sensitivity 29.7 mV/Pa (-32.7 dB)	
Signal / Noise Ratio 81 dB typical (@ 1 kHz/Pa A-weighted)	



RYC079004

Polar response

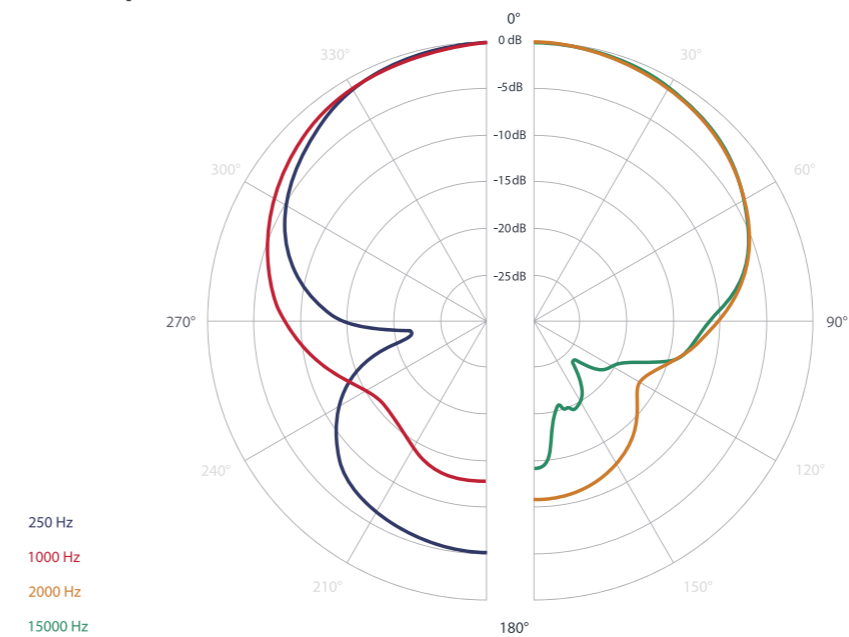

Frequency response

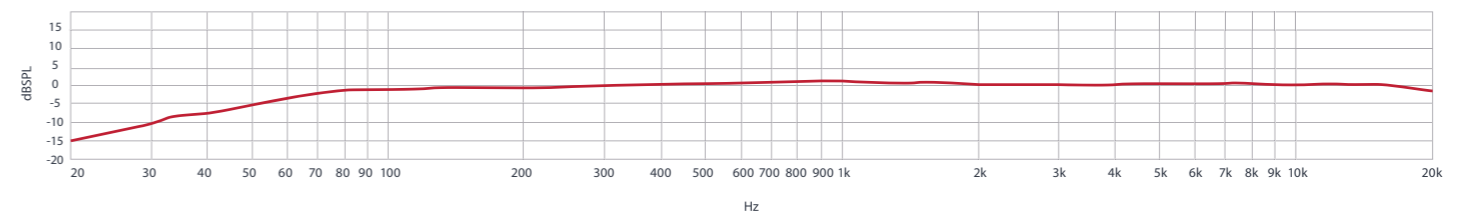

OM-08 Omnidirectional Microphone

The Rycote® OM-08 is an omnidirectional pencil condenser microphone designed for a range of applications in studio and field recording. The OM-08 microphones provide solid low frequency response with virtually no drop off at 20Hz. The mics are built on Rycote's low self-noise preamp design and capsules which offer a consistent sonic signature that mixes well when cut together with other Rycote® microphones in the range. The OM-08 mics can be used individually or in matched stereo pairs.

Specifications

Length 78mm	Powering P-48
Frequency Range 10 Hz – 20 kHz	Max. SPL 133 dB SPL (@ 1 kHz 1.0% THD typical)
Self Noise 11.0 dBA (±2dB)	Connector XLR-3M
Polar Pattern Omnidirectional	Weight 69 g
Capsule Type Back Electret Condenser	Colour Black with Red Accent
Output Sensitivity 23.0 mV/Pa (-26,3 dB)	
Signal / Noise Ratio 81 dB typical (@ 1 kHz/Pa A-weighted)	



RYC079005

Polar response

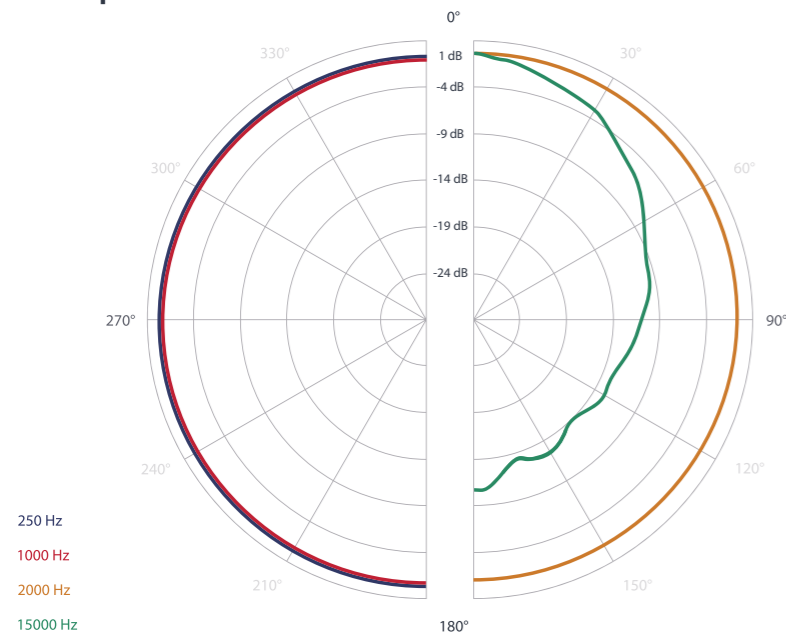

Frequency response

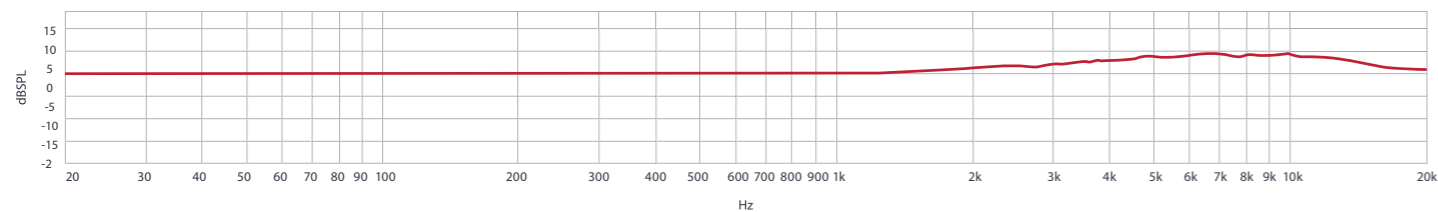



LAVALIER SOLUTIONS

05 /

We have designed a line of products for lavalier mics using our signature wind & noise protection.

Essentials Advanced page 66



Essential Original page 68



Lavalier Foams page 68



Lavalier Windjammer page 69



Essentials Advanced

Stickies Advanced

Stickies Advanced are double-sided, hypoallergenic, adhesive pads used to affix lavalier microphones directly onto skin or on top of clothing. The soft fabric sandwiched between the two adhesive pads prevents the adhered mic from creaking due to skin or clothing movement. Stickies Advanced are designed to remain secure when attached to a dry surface and are intended to be discarded after use.



KEY FEATURES

- Stickier hypoallergenic adhesive on both sides
- Supplied loose with easy peel-off tabs to make use easier
- Round – larger diameter means perfect for use with the ever-popular DPA Concealers
- O's – allow wind protection on DPA Concealers, or folded-over with Overcovers
- Squared – perfect for use with Sanken RM-11 (the rubber mount produced for the ubiquitous Sanken 'COS-11' mic) & for general cable management on radio mics



*Please visit our website: <https://rycote.com/microphone-windshield-shock-mount/lavalier-solutions/> to see all the possible packs.

Overcovers Advanced

Overcovers utilise Rycote® exclusive fur technology, providing excellent wind-noise protection for lavalier microphones. They consist of a discreet, fur covering and are supplied with Stickies. With a Stickie affixed to clothing or skin, a fur disc is affixed over the top of a lavalier microphone.



KEY FEATURES

- Large size (26mm) ideal for DPA Concealers
- Supplied with Stickies Adv Round, at 23mm also bigger than 'Originals'
- Introducing new beige colour – to cater for even more applications
- Available in Black, Grey, Beige & White
- Available in Packs of 5 Overcovers (with 25 x Stickies, Round) & Bags of 100 (Overcovers only)

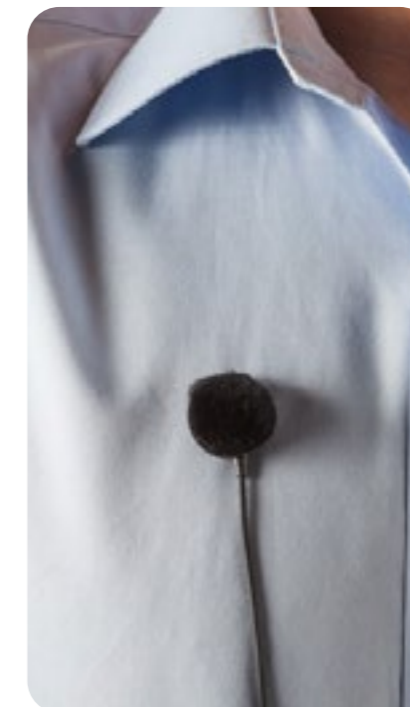

*Please visit our website: <https://rycote.com/microphone-windshield-shock-mount/lavalier-solutions/> to see all the possible packs.

Essentials Original

Stickies Original



Stickies are double-sided, hypoallergenic, adhesive pads used to affix lavalier microphones directly onto skin or on top of clothing. The soft fabric sandwiched between the two adhesive pads prevents the adhered mic from creaking due to skin or clothing movement.

Undercovers Original



Undercovers are the perfect solution to completely hide lavalier microphones. Used with the included Stickies, these soft, fabric discs are designed to minimize the sound of clothing movement while providing protection from light wind.

Overcovers Original



Overcovers use Rycote exclusive fur technology, providing excellent wind-noise protection for lavalier microphones. They consist of discreet, fur Windjammer® and Stickies. With a Stickie affixed to clothing or skin, a fur Windjammer disc is fixed over the top of a lavalier microphone.

Compatible with a huge range of lavalier microphones

All of our Stickies, Undercovers and Overcovers are compatible with a huge range of industry standard lavalier microphones. We have designed the Stickies Round to be perfect for use with DPA Concealers, and the Stickies Squared are perfect for use with the Sanken RM-11 mount (for the COS-11D lav mic).

*Full packs available: <https://rycote.com/microphone-windshield-shock-mount/lavalier-solutions/>

Lavalier foams

Rycote® foams for lavaliers are discreet, slip-on foam windshields, designed to protect personal microphones against light wind and pop noise. Made of durable, high quality open-cell acoustic foam, Lavalier Foam windshields offer up to 20dB of pop and wind noise attenuation, whilst avoiding concurrent high frequency loss. Engineered exclusively for Rycote®, this high-quality foam material also provides excellent resistance against the damaging effects of moisture and UV light.



Water repellent Lavalier foam

Designed for Lavalier mics, Neoprene coated to repel water when used in light-rain conditions. Suitable for Lavalier mics of 4.5 to 6.0 mm in diameter and up to 15 mm length.

VT Miniature Lavalier foam

Suitable for Voice Technologies VT-100 Lavalier mics.

Miniature Lavalier foam

Suitable for Lavalier mics of 2.8 to 4.5 mm in diameter and up to 15 mm length.

Water repellent mini Lavalier foam

Designed for smaller Lavalier mics, Neoprene coated to repel water when used in light-rain conditions. Suitable for Lavalier mics of 2.8 to 4.5 mm in diameter and up to 15 mm length.

Lavalier Foams Microphone compatibility

Order Code	Product	Microphone Compatibility
RYC105504	Miniature Lavalier Foams Black (1 pack of 2)	BeyerDynamic: MCE7
RYC105514	Miniature Lavalier Foams Black (1 pack of 10)	Countryman: B6
RYC105526	Neoprene-coated Mini Lavalier Foam	Sanken: COS11 Sony: ECM88
RYC105515	VT Miniature Foam Black (1 pack of 50)	Voice Technologies: VT-100
RYC105501	Lavalier Foams Black (1 pack of 5)	AKG: C577, CK77, CK97
RYC105511	Lavalier Foams Black (10 packs of 5)	Audio-Technica: AT 899
RYC105502	Lavalier Foams Beige (1 pack of 5)	Countryman: B3, EMW
RYC105512	Lavalier Foams Beige (10 packs of 5)	DPA: 4061, 4062, 4071
RYC105503	Lavalier Foams Brown (1 packs of 5)	Electrovoice: RE90L
RYC105513	Lavalier Foams Brown (10 packs of 5)	PSC: FPSCNM
RYC105525	Neoprene coated Lavalier Foam	Sennheiser: MKE 2, ME 102, ME 104
		Shure: SM93, WL50, WL51, ECM77
		Tram: TR50
		Voice Technologies: VT-500

Windjammer

Lavalier Windjammer

Perfect for use in windy outdoor conditions in news, documentary, and interview applications, the Lavalier Windjammer® provides excellent wind-noise and plosive protection. Offering superb wind isolation for Lavalier mics, these robust problem-solvers work with lavalier mics on clips or necklaces, can be pinned to clothing, and can even be used underneath clothing layers to remove unwanted 'rustling' noise. A foam connector with a rubber ring ensures secure connection to the microphone.



Ristretto Windjammer

The Rycote® Ristretto Windjammer® is also designed to significantly reduce wind noise and plosives on lavalier microphones. As broadcasters often prefer their microphones and wind protection to remain as unobtrusive as possible when on camera, we have designed 'The Ristretto' to offer wind protection for lavalier microphones but with a more discreet appearance, as the fur is considerably shorter than that on the Rycote® Lavalier Windjammer®. The Ristretto Windjammer® is secured to a microphone by a foam connector with a rubber ring for grip and retention.



Lavalier Windjammer / Ristretto Windjammer Microphone compatibility

Order Code Single	Order Code Pair	Product	Microphone Compatibility
RYC065514	RYC065501	Lavalier Windjammer - black	AKG: C577, CK77, CK97
RYC065515	RYC065515	Lavalier Windjammer - grey	Audio-Technica: AT 899 ;
RYC065516	RYC065503	Lavalier Windjammer - white	BeyerDynamic: MCE7
RYC065564	RYC065561	Lavalier Windjammer - green	Countryman: B3, B6, EMW ;
RYC065566	RYC065563	Lavalier Windjammer - blue	DPA: 4061, 4062, 4071, Core 6061 ;
RYC065565	RYC065562	Lavalier Windjammer - red	Electrovoice: RE90L
RYC065555	RYC065552	Ristretto Lav. Windj. - black	PSC: FPSCNM
RYC065556	RYC065553	Ristretto Lav. Windj. - grey	Sanken: COS11 ;
RYC065557	RYC065554	Ristretto Lav. Windj. - white	Sennheiser: MKE 2, ME 102, ME 104, MKE Essential Omni ;
			Shure: SM93, WL50, WL51, ECM77
			Sony: ECM88
			Tram: TR50
			Voice Technologies: VT-100, VT-500 ;
			Zoom: LMF1

*Please visit our website: <https://rycote.com/microphone-windshield-shock-mount/lavalier-solutions/> to see all the possible Lavalier Windjammer kits.



PORTABLE RECORDER / ON CAMERA 06/

Portable recorder solutions

page 74



Mini Windjammer

page 76



Micro Windjammer

page 78



Portable Recorder Solutions



The right tools to make your next recording shine.

Whether capturing broadcast news, documentary or your next podcast, Rycote® has the right tools to make your next recording shine. There are dozens of portable recorder models on the market for 'field recording', and Rycote® has a range of products to provide the all-important wind and handling protection. Rycote® Portable Recorder Suspensions, Mini Windjammer® and all-in-one Kits really are essential items to help you capture the best possible audio with your portable recorder, whatever the application!

Portable Recorders Kits

Our Kits have been assembled to provide professional wind and shock protection for a multitude of applications where portable recorders are frequently used. Whether for news, documentary, podcasting or nature recording while hand-held, stand, boom pole or camera mounting – Rycote® Portable Recorder Kits provide the versatility to help capture the best possible audio for outdoor and indoor applications alike.

- Mini Windjammer®
- Portable Recorder Suspension
- Hot shoe 3/8" adaptor
- 3/4" adaptor
- Soft grip extension handle



Portable Recorders Suspensions

Available in two models to best suit specific recorder size and weight specifications, the durable Lyre® Technology provides outstanding isolation from vibrations, shock and handling noise. The standard 3/8" thread is suitable for boom pole and camera hot shoe mounting, whilst the 3/4" adaptor provides versatility to fit microphone stands. The easy-to-use 180° swivel is perfect for orienting the recorder microphones in the direction of the desired sound source.



Mini Windjammer for Portable Recorders

The Mini Windjammer® is made from the same tried and tested material that we use for our acclaimed professional 'full size' wind-protection products. Available for most of the popular contemporary portable recorder models, the slip-on Windjammer® provides excellent wind protection for professional-quality results in a wealth of outdoor news, documentary and podcasting applications.



Kits and portable recorder compatibility

Mini Windjammer Order Code	Suspensions Order Code	Portable Kit Order Code	Portable Recorder Compatibility
RCY055411	RCY041119	RCY046009	Edirol R05
RCY055398	RCY041119	RCY046004	Olympus LS-05/LS-10/LS-11/LS-12/LS-14
RCY055419	RCY041130	RCY046011	Roland R-26
RCY055458	RCY041130	RCY046024	Sony PCM-D100
RCY055444	RCY041119	RCY046015	Tascam DR-40
RCY055384	RCY041119	RCY046003	Tascam DR-100/DR-100 MKII
RCY055406	RCY041119	RCY046010	Zoom H1
RCY055471	RCY041119	RCY046029	Zoom H1N
RCY055439	RCY041119	RCY046016	Zoom H2N
RCY055438	RCY041119	RCY046001	Zoom H4N
RCY055462	RCY041119	RCY046025	Zoom H5
RCY055454	RCY041130	RCY046023	Zoom H6

Mini Windjammer



Professional wind isolation for all sorts of recording devices.

As well as offering a range of Mini Windjammer® models to fit microphones designed for on-camera mounting, Rycote also makes Mini Windjammer® products for a range of other portable recording devices. The same principle applies... the Mini Windjammer® is made to slip over the specific recording device and provide superb wind isolation!

Rycote Mini Windjammer® models are tailored to fit mics that are specifically designed for camera hot shoe mounting, providing superb wind-noise isolation. Made to slip over the foam windshields supplied with these purpose-built microphones, the Mini Windjammer® provides the best possible wind isolation, with virtually no adverse effect on high frequencies. Essential if you want to record audio outdoors!



Microphone compatibility

Product Order Code	Microphone Compatibility
RCY055470	Røde VideoMic Pro+
RCY055430	Røde Stereo VideoMic Pro
RCY055459	Røde VideoMic (all models)
RCY055455	Røde VideoMic Go
RCY055465	Røde VideoMic Pro with Lyre
RCY055447	Shure VP83 / VP83F
RCY055364	Sennheiser MKE400

Mini Windjammer for Other Portable Devices

These small, lightweight and ingenious new products from these highly respected brands are sure to be popular. From a 'go anywhere' portable 'VR' audio recorder - to microphones that enable the capture of great audio on smartphones - these 'on the go' products will undoubtedly be used extensively outdoors... which is where we come in! Tailor made for a great fit and using our famous synthetic fur - an authentic, professional quality Rycote Mini Windjammer® is an essential item to help capture the best possible audio - whatever the application!



Sennheiser Memory Mic
Microphone for smartphones
RCY055474



Zoom H3-VR
Handy 'virtual reality' audio recorder
RCY055476



Shure MOTIV™ MV88
iOS digital stereo condenser mic
RCY055477

Device compatibility

Product Order Code	Device Compatibility
RCY055474	Sennheiser Memory Mic
RCY055476	Zoom H3-VR
RCY055477	Shure MV88

Micro Windjammer



Versatile wind protection for built-in microphones.

Even the smallest cameras allow you to shoot great, highquality video. But if you've ever tried filming outdoors, you know that wind noise can wreck a perfectly good video in a matter of seconds! That's why Rycote® has developed the Micro Windjammer® - to greatly reduce wind noise around the built-in microphone - to help you capture better audio with your camera outdoors.

Great for DSLRs and portable device too!

There has been a huge rise in popularity of DSLR video as a fantastic means of motion storytelling and memory capture. However, the built-in mics on DSLRs are highly susceptible to the effects of wind noise. The Micro Windjammer® provides a simple fix. They are handy, easy to fit and provide, excellent all-in-one wind protection for DSLR cameras.

Each individual Micro Windjammer® pack contains 30 Stickies and 6 reusable synthetic fur discs (grey).



Wind protection for your other portable video devices too!

The Micro Windjammer® is also compatible with Apple iPhones, iPads, Samsung Galaxy's and most other smartphones - significantly improving the outdoor sound quality when shooting your vlogs, YouTube or Facebook videos! And they leave no unpleasant residue on removal from your precious device!



ACCESSORIES

07 /

Rycote offer a wide range of accessories for audio professionals.

Professional Connection System

page 80



Lyres

page 82



Microphone Flags

page 84



Connboxes

page 85



Cover, Rain Jacket & Cases

page 86



Handles

page 90



Professional Connection System



Easy, Solid and Noise-free

The Professional Connection System (PCS) is the all-new quick attach/quick release connection system from Rycote®. The first Rycote® PCS product is the new PCS-Boom Connector, which has been designed for professional boom pole use.

Rycote® has built on the PCS Boom Connector's success to create a complete system for quicker, more secure, and less complicated workflow than sound professionals have been able to enjoy so far.

Rycote® has developed the new system in response to the clear need for assisting production sound mixers, boom ops, sound recordists and audio engineers - whether in the field, studio, theatre, or at live events - in achieving a quick and simple workflow.

KEY FEATURES

Noise-free connection

Crucially for professional audio use, the PCS-Boom Connector is designed to remain completely secure and noise-free during use... essential for anything going on the end of a boom pole!

The thread connection is a high-grade aluminium, with a twin locking screw arrangement. The connection grips the boom pole thread, without damaging it - and makes for a reassuringly solid connection.

Easy connection & release mechanism.

With its easy one handed 'click-in' attachment and pull collar release mechanism, the PCS-Boom Connector provides incredibly fast and easy operation.

The positive 'click' on being pressed in and fitted gives you the confidence that it is connected and secure. Releasing is a simple matter of pulling down the outer collar on the PCS-Boom Connector - completely intuitive.

Simply 'click' - and boom!

The PCS 'tip' locks into any 3/8" female threaded windshield kit/shock-mount - made by Rycote or other manufacturers - and stays fitted.

The Connector attaches securely to the boom pole. Connection/release is then a quick and easy 'click' in/pull-out operation! This allows for super-fast swapping of your different mics (and windshield kits) on and off... perfect for all manner of production sound recording applications!

Professional Connection System Range



PCS-Organizer - RYC185800

Mount to any flat surface, and affix the included 3/8" male 'tip' to your mic's shock-mount, windshield or other accessory. Keep your workflow organized!

PCS-Boom Connector - RYC185801

Attach the Connector to any 3/8" threaded boom pole, and affix the included 3/8" male 'tip' to your mic's shock-mount or windshield. Universal 3/8" compatibility!

PCS-Spigot - RYC185803

Create a more efficient and safer workplace with the PCS-Spigot. Specially designed to be fitted to stands and arms with a 5/8"(16mm) spigot connector. 3/8" male tip included.

PCS-Lite 3/8" - RYC185802

Your most economic and general purpose quick release/attach system. Convert stands and arms into a secure and easy quick release for any accessory with a 3/8" thread.

PCS-Lite 5/8" - RYC185812

Specifically designed for the (MI) industry with its 5/8" thread compatibility. Attach to your studio stand or arm straight out the box for an intuitive quick release/attach system. 5/8" male tip included.

PCS-Utility - RYC185804

A universal quick release system that can withstand the toughest of conditions. Affix this solid and reliable quick release to any 3/8" threaded arm, stand and Rycote Half Coupler. 3/8" male tip included.

Lyres



Clever, versatile and virtually unbreakable

Rycote® shock-mounts & suspensions feature patented Rycote® Lyre® technology, for superior shock isolation against handling noise. Think of the Lyre® like a 'shock absorber' – the clever design providing highly accurate control of compliance in 3 directional axes to brilliantly isolate your microphone from handling noise. Lyre® are extremely robust, virtually unbreakable in fact, and they do not use elastic or rubber components which are prone to wear and tear.

KEY FEATURES

No elasticated parts

The patented Lyre® are extremely robust, and virtually unbreakable, as they do not use no elastic or rubber components which are prone to wear and tear. These completely backward compatible Lyre® have replaced the original silicone O-rings suspension, and can be bought separately to upgrade older suspensions.

Virtually unbreakable

The Hytrel material that Rycote® uses not only damps smoothly but maintains its characteristics even down to arctic temperatures. It also has a 'shape memory' that allows it to be tied in eye-watering knots without developing a permanent 'set' – or snapping!

Enhanced Technology

The Lyre® has now been enhanced with a soft-grip internal surface on the mic clip. The soft-grip helps prevent the mic twisting or slipping, and helps prevent the clip from scratching the surface of the microphones, which are often powder-coated.

Lyre hardness options

The lower the number (measured in 'Shore' rating), the softer the Lyre®. So, a 62 Shore Lyre® is softer than a 72 Shore, and the 82 Shore Lyre® is the stiffest we make. The different hardness rating of the Lyre can be identified by their colour combinations.

Upgrade Lyre kits are available to convert previous rubber & elastic Rycote® suspensions.



62 Shore
RCY042255



72 Shore
RCY042210



82 Shore
RCY042216

Shore hardness Color Combination

62 shore: Black Lyre® material & Black Soft-grip

72 shore: Black Lyre® material & Grey Soft-grip

82 shore: Light Grey Lyre® material & Black Soft-grip

Microphone Flags



Lightweight and extremely hard-wearing

Rycote's Microphone Flags are lightweight, sponsorship friendly and built for longevity. Our design team removed their weakest link – perishable foam inserts, replacing them with hard-wearing rubber vanes so they are just as effective tomorrow as they are today.

KEY FEATURES

Innovative microphone grip

The Mic Flags are made from durable shatterproof moulded plastic. An array of internally fitted hard-wearing red and black rubber 'vanes' secures the flag around the microphone, allowing the Rycote® Mic Flags to be used with any microphones.

Fits large or small mics

The Mic Flag will securely hold smaller mics, from 19 to 32mm diameter. Simply un-slot and remove all the vanes of one of the colours (either all the black vanes or all the red ones) and the Mic Flag will now accommodate larger mics, up to 38mm in diameter.

Branding

Rycote Mic Flags provide a large printable area for sponsors' logos. Three and four-sided Flags are available, in either black or white. The square Flag offers a printable logo area 57mm wide by 48mm high on each of its four sides; while the printable area of each side of the triangular Flag measure 89.5mm wide by 48mm.

Connboxes



Designed to greatly reduce handling & cable-borne noise

The Connbox has been designed to isolate and greatly reduce handling and cable-borne noise to the microphone. An effective and ready-to-use solution to connection problems, the Connbox will enable professional sound recordists to achieve clean, high quality audio recordings.

KEY FEATURES

High quality components

The Connbox is made of the highest quality components, using a Gold 5-pin Neutrik X-series XLR connector, and an ultra soft Mogami star-quad cable. Isolates and minimises handling and cable-borne noise. Greatly improves audio quality of recordings. A ready-to-use solution to connection problems

Ready-to-use solution

Acting as a transition connector and anchor point for the microphone tail, the lengths of cable are set to work perfectly with the microphone fitted in the windshield, without touching the internal surface of the basket. The soft cable then greatly reduces the transmission path of cable-borne noise, thus further reducing cable rumble.

Kits

Connbox CB1 (XLR-3F) - RYC016901

Single, hardwired XLR-3F input tail, and a single XLR-3M output

Connbox CB3 (2XLR-3F) - RYC016924

Two hardwired XLR-3F input tails routed to a single XLR-5M output

Connbox CB4 (XLR-5F) - RYC016925

Single, hardwired XLR-5F input tail routed to a single XLR-5M output

Connbox CB9 (MZL) - RYC016917

Single, hardwired MZL input tail routed to a single XLR-3M output

Connbox CB10 (LEMO) - RYC016918

Single, hardwired LEMO input tail routed to a single XLR-3M output

Cover, Rain Jacket & Cases



Keep your valuable mics in pristine condition

You've always trusted Rycote® to protect your audio from wind and handling noise – now we can help with protecting your precious audio equipment too!

Windshield Rain Jacket

The Rycote® Windshield Rain Jacket is a handy, water-resistant 'jacket', for quickly and neatly covering your microphone windshield and helping to protect it from the elements... in between 'takes'! Whether it's for location sound applications or outside sports broadcasting – this purpose-built product will help protect your valuable windshields and microphones from the worst of the elements.

KEY FEATURES

Highly water-resistant

Highly water-resistant, lightweight, rugged microphone windshield rain 'jacket'. Emergency windshield protection from unexpected weather conditions, such as rain, snow, sleet and dust. Quick and easy to pull on and secure & easy to remove – great for changeable weather conditions.

Lightweight protection

'Carbon-weave' effect material with soft-fabric lining protects windshield & Windjammer®. Provides re-usable (more 'eco-friendly') protection, compared to plastic bags! This 'Medium' size (40cm length) fits popular windshields/'blimps' like the Rycote® Modular Windshield WS 4 Kit.

Draw-string fastening

Draw-string fastening at the bottom accommodates attachment of windshield to tripods, stands and boom-poles. Sewn-in loop allows for easy hanging of the jacket, for quicker drying. Includes a mesh material drying/storage carry-bag.

Windshield Compatibility

Windshield Rain Jacket, Medium - RYC079964

Rycote Modular Windshield Kit (WS 1, 2, 3, 4, 9, 10 & 295)
 Rycote Super-Shield Kit ('Small' and 'Medium')
 Rycote Cyclone Windshield Kit ('Small' and 'Medium')
 Rycote 'Perfect For' basket windshield kits
 Rycote Stereo Windshield Kit (ORTF)

Also compatible with any Rycote slip-on windshield/InVision shock mount combination (or third party windshield), with a total length of up to 43cm)

This product is not intended to be used whilst recording audio



Duck Raincover

The Rycote® Duck Raincover is available in different sizes to fit a wide variety of our windshield kits, and is an indispensable accessory for recording in wet weather conditions. The 'Duck' is made of open cell foam that helps diffuse the sound made by rain droplets landing on it. The design of the weather-proof back cover, provides areas of 'space' between it and the windshield/Windjammer, helping to minimise transmission of rain noise and allowing water to flow away from the windshield.



Order Code	Product	Suitable for
RYC214111	Duck Raincover 1	Modular WS 1 Kit
RYC214112	Duck Raincover 2	Modular WS 2 Kit
RYC214113	Duck Raincover 3	Modular WS 3 Kit & Super-Shield Small
RYC214101	Duck Raincover 4	Modular WS 4/5 Kit, and the Super-Shield Medium and Large Kits
RYC214125	Duck Raincover 6	Modular WS 6 Kit
RYC214127	Duck Raincover 7	Modular WS 7 Kit
RYC214126	Duck Raincover 8	Modular WS 8 Kit
RYC214120	Stereo Duck Raincover AD	Stereo AD Kit
RYC214121	Stereo Duck Raincover AE	Stereo AE Kit
RYC214122	Stereo Duck Raincover AF	Stereo AF Kit
RYC214123	Stereo Duck Raincover AG	Stereo AG Kit

For more information, see www.mymic.rycote.com/products/accessories-parts/duck-raincover/

Hi-Wind Cover

The Hi-Wind Cover is designed to fit the Modular Windshield Kit to offer up to 35dB in wind noise reduction. It is manufactured from a durable black 'fleece' material and is easy to fit 'in the field' by simply sliding it over the windshield basket, and securing in place with hook and loop fastening pads. The Hi-Wind Cover provides added flexibility, offering a level of wind protection performance that's greater than the basket on its own, but less than the basket with a Windjammer fitted.



Order Code	Product	Suitable for
RYC022509	Hi Wind Cover 9	Modular Windshield WS 9 Kit
RYC022516	Hi Wind Cover 10	Modular Windshield WS 10 Kit
RYC022501	Hi Wind Cover 1	Modular Windshield WS 1 Kit
RYC022502	Hi Wind Cover 2	Modular Windshield WS 2 Kit
RYC022503	Hi Wind Cover 3	Modular Windshield WS 3 Kit
022511	Hi Wind Cover 295	Modular Windshield WS 295 Kit
022504	Hi Wind Cover 4	Modular Windshield WS 4 Kit
022505	Hi Wind Cover 5	Modular Windshield WS 5 Kit
RYC022506	Hi Wind Cover 6	Modular Windshield WS 6 Kit
RYC022507	Hi Wind Cover 7	Modular Windshield WS 7 Kit
RYC022523	Hi Wind Cover 8J	Modular Windshield WS 8J Kit
RYC022508	Hi Wind Cover 8	Modular Windshield WS 8 Kit
RYC022524	Hi Wind Cover Røde Blimp	Røde Blimp
RYC022627	Stereo Hi Wind Cover AC	Stereo Windshield AC Kit
RYC022628	Stereo Hi Wind Cover AE	Stereo Windshield AE Kit
RYC022629	Stereo Hi Wind Cover AF	Stereo Windshield AF Kit
RYC022630	Stereo Hi Wind Cover AG	Stereo Windshield AG Kit
RYC022631	Stereo Hi Wind Cover AD	Stereo Windshield AD Kit

For more information, see www.mymic.rycote.com/producttypes/hi-wind-cover/

Mic Protector Case

The Rycote® Mic Protector Case is a supremely tough, water resistant case designed to carry and safely protect up to 3 small diaphragm microphones. Available in 2 lengths – a 20cm and a 30cm version – this Case has been designed with location/production sound professionals firmly in mind. Durable, lightweight and practical, the Mic Protector Case is a really useful addition to your sound kit.

Each Mic Protector Case comes with 3 clear plastic Mic Tubes to provide additional protection for your mics. With a clever 'threaded' design, each cylindrical mic tube is extendable – from 200mm to 340mm* or from 125mm to 180mm** in length.

*Included with Mic Protector Case, 30cm
 **Included with Mic Protector Case, 20cm

KEY FEATURES



- Fits up to 3 x small diaphragm microphones
- Super-robust tubular PVC case with heavy-duty outer fabric layer (600D Oxford Nylon)
- Supplied with three protective, telescopic plastic Mic Tubes
- Lightweight, webbed carry strap
- Handy lightweight carabiner for quick & secure fastening
- Water resistant zip-fastening system with easy pull toggle
- Silica gel sachets included, to help ensure a healthy climate for your mics
- Suitable for a wide range of mics

Microphones compatibility

Order Code	Product	Microphone Compatibility
RYC079903	Mic Protector Case, 30cm Includes 3 x PVC telescopic mic tubes (short)	A wide range of mics from 19-25mm diameter, and of various lengths, including the Schoeps MiniCMIT and Sennheiser MKH 50
RYC022512	Mic Protector Case, 20cm Includes 3 x PVC telescopic mic tubes (long)	A wide range of mics from 19-25mm diameter, and of various lengths, including the Sennheiser MKH 416 and Rode NTG Series

For full list of compatible microphones, see: <https://rycote.com/microphone-windshield-shock-mount/mic-protector-case/>

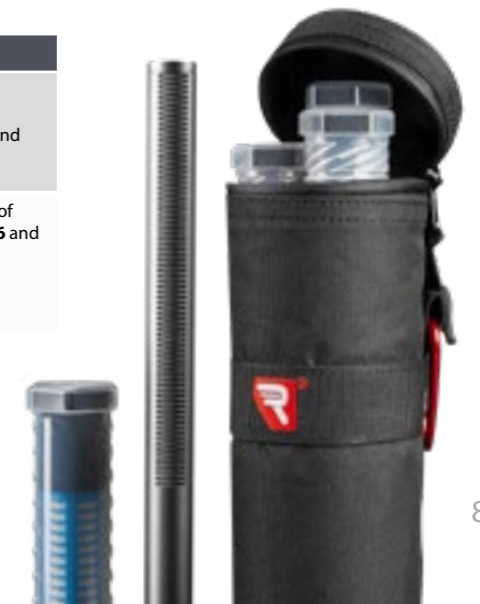

Handles



Tough, comfortable and dependable

Rycote® handles are available to fit all of our suspension systems. The Pistol Grip is compatible with Rycote® Windshield suspensions and is supplied in a wide range of our Windshields, suspensions and Softie® Kits. The Soft Grip Extension Handle is compatible with any shock mount featuring a 3/8" female Whitworth/UNC thread.

Rycote® handles are a convenient and ergonomic way to operate your Rycote® windshield & shock mounts comfortably. They can be hand-held or attached to a boom pole via the convenient 3/8" female thread attachment at the base.



Pistol Grip Handle

Cable management is an integral design feature on the Pistol Grip handles, with the cable running through the handle assembly to help minimise any handling noise and to reduce clutter. They also feature a handy release lever on the mount (Star Knob or Lever), allowing for quick and easy adjustment of the microphone angle. The handle is fitted with a soft-feel grip, that enables you to comfortably hand-hold simple microphone mounts.

Pistol Grip Handle with Lever - RYC048401

Suitable as a replacement or addition to a range of basket systems, where the user has only the Boom Poles Adaptor. Features an extra secure rotary lever and space for mounting an XLR output connector.

Pistol Grip Handle with Star Knob - RYC048438

Suitable as a replacement or addition to a range of basket systems, where the user has only the Boom Poles Adaptor. Features an extra secure rotary star knob and space for mounting an XLR output connector.



Soft Grip Extension Handle

The Rycote® Soft Grip Extension Handle has been designed to allow products with a female 3/8" thread, e.g. portable audio recorders, to be either hand-held or mounted on a 3/8" male thread, such as on a microphone stand or boom pole.

Thanks to its ergonomic, soft-grip feel, the handle can be used to comfortably hand-hold recording devices, and can be used together with our Portable Recorder Suspension, or InVision® Broadcast suspension mounts.

Soft Grip Extension Handle - RYC037301

Suitable for products with a female 3/8" thread (i.e. portable audio recorder or camera) to be either hand-held or mounted on a 3/8" male thread (e.g. microphone stand or boom pole).

Perfect For

The Rycote® 'Perfect For' range is a range of 'microphone specific' products, designed to perfectly compliment key, popular microphones: **Røde NTG Range, Sennheiser MKH 416, Schoeps CMIT 5, Schoeps MiniCMIT, Schoeps CMC-1, Sanken CS-M1.**

Designed and optimised for these key industry microphones, the Perfect for range incorporates existing, industry-leading Rycote® technologies that work with your microphone – straight out of the box.

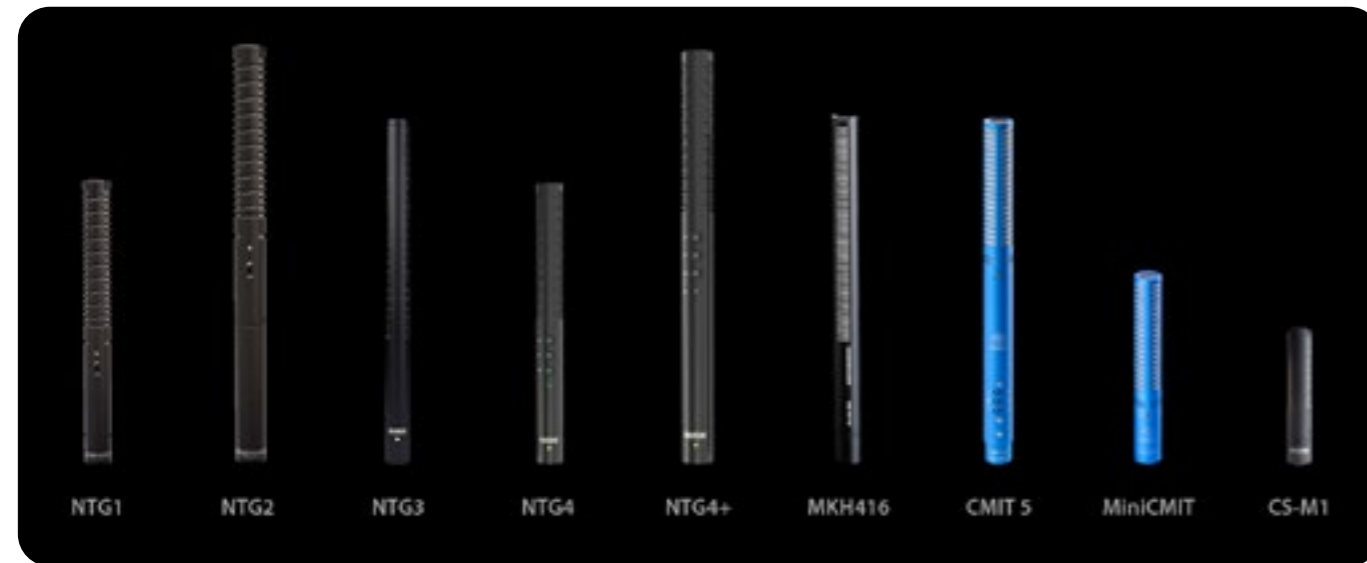

Perfect for Schoeps Microphones

Super-Softie Kit, CMIT

Aerodynamic and durable; the Super-Softie® Kit, CMIT slip-on microphone windshield and shock mounting system provides superior performance and unparalleled durability for your Schoeps CMIT.



RCY033208

Windshield Kit, MiniCMIT

Incredibly sleek and compact, the Windshield Kit, MiniCMIT offers finely-tuned wind and handling noise protection for the new Schoeps MiniCMIT.



RCY086072

Windshield 9 Kit, CMC-1

Incredibly sleek and compact, the Windshield 9 Kit, CMC-1 offers finely-tuned wind and handling noise protection for the new Schoeps CMC-1 fitted with a Mk4 or Mk41 capsules.



RCY010325

Perfect for Røde NTG Range

Super-Blimp Kit NTG

Compact, light, and acoustically transparent, the Super-Blimp Kit brings industry-leading Rycote® wind and handling noise protection to the Røde NTG series of microphones.



RCY010323

Super-Blimp NTG5

Specifically designed and proportionally sized for the Røde NTG5 shotgun mic, the Rycote® Super-Blimp NTG5 kit brings industry leading Rycote® wind and handling noise protection with the sleek basket design, lo-profile XLR connector and the patented Lyre® technology.



RCY010326

Softie Kit, NTG

The Softie® Kit incorporates Rycote®'s Duo-Lyre suspension for massive handling noise reduction and superior sound quality. It's light, fast and effective in any recording situation.



RCY033394

Perfect for Sennheiser 416

Windshield Kit, 416

Featuring patented Lyre® technology, Rycote® basket windshield, premium short XLR connectors and professional-quality Mogami cable.



RCY010324

Super-Softie Kit, 416

This slip-on windshield solution features our revolutionary, highly durable 3D-TeX® material for dramatically increased acoustic transparency, long-term durability and reliable performance in poor weather.



RCY033207

Perfect for Sanken CS-M1

Softie Kit, CS-M1

The Softie® Kit, CS-M1 is tailor-made to allow you to capture the best possible audio with the Sanken CS-M1 mic... whether for boom pole or camera mounted use. Comes with a shoe adaptor for easy attachment to a camera hot / cold shoe. (Cable not included)



RCY033395



On the information in this catalogue: changes to products may have been made after the editorial deadline for this catalogue. Please ask your Rycote Dealer for the latest information. Error printing mistakes and technical changes reserved.