

## 2000R Series Air Curtain Recessed Mount Models

For indoor use: openings up to 9ft-10in [3m] height



Models: 2047R, 2063R, 2083R: Ambient air – No heat  
2047EHR, 2063EHR, 2083EHR: Electric heat  
2047WHR, 2063WHR, 2083WHR: Hot water heat

Conforms to:  
CAN CSA-C22.2 no.46-13  
& UL 2021(Ed.3): 2013

## Installation, Operation and Maintenance Instructions

Installer: Complete the following for future reference.  
Present manual to end user for safe keeping in file.

Date of Purchase .....

Model Number .....

Serial Number .....

Model and Serial numbers are required when contacting the manufacturer's service department.  
Proof of purchase is required to make a claim under warranty.

Schwank and Infrasave:

### USA

2 Schwank Way  
Waynesboro, GA 30830

### Canada

5285 Bradco Blvd.  
Mississauga, ON L4W 2A6

Tel: 1-877-446-3727  
Fax: 1-866-361-0523  
www.schwankgroup.com  
csr@schwankgroup.com  
csr@infrasave.com

IM030417  
2000R Recessed Mount Manual  
April 1, 2017  
RL: 1A

**WARNING: TO REDUCE THE RISK OF FIRE, ELECTRIC SHOCK OR INJURY TO PERSONS, OBSERVE THE FOLLOWING:**

When using electrical appliances, basic precautions should always be followed to reduce the risk of fire, electric shock and injury to persons, including the following:

1. Read all instructions before installing or using this air curtain heater.
2. This air curtain heater can be hot when in use. To avoid burns, do not let bare skin touch hot surfaces. To avoid a fire situation keep combustible materials, such as paper, curtains, blinds, clothing, etc. at least 4 feet (1.2m) from any part of the air curtain heater; front, sides and rear and away from the warm air discharge.
3. Extreme caution is necessary when the air curtain heater is used by or near children or invalids and whenever the unit is left operating and unattended.
4. Do not operate the air curtain heater if it malfunctions. Disconnect electrical power at service panel and have unit inspected by a reputable electrician before reusing.
5. Do not install or use the air curtain heater outdoors.
6. To disconnect the air curtain heater, turn off at the remote control (see Section 11. Remote Control Operation) and turn off electrical power to air curtain heater circuit at main disconnect panel (or operate local disconnect switch if provided)
7. Do not insert or allow foreign objects to enter any air inlet or discharge opening as this may cause an electric shock or fire, or damage the air curtain heater.
8. To prevent a possible fire, do not block air inlets or discharge openings in any manner.
9. An air curtain heater has hot and arcing or sparking parts inside. Do not install and use it in areas where gasoline, paint or flammable vapors or liquids are used or stored.
10. Use this air curtain heater only as described in this instruction manual. Any other use not recommended by the manufacturer may cause fire, electric shock or injury to persons.
11. If this air curtain heater is electric heated it has an overheat safety cut-out system which will operate if temperatures at the electric heating elements get excessive and prevent the electric heating elements functioning. This is indicated by flashing LEDs on the Remote Control. If this happens refer to Section 8.2 & Section 14.1 Overheat Safety cut-out for further instructions.

**12. SAVE THESE INSTRUCTIONS**

## Table of Contents

	Page
1. ELECTRICAL SAFETY .....	4
2. SPECIFICATIONS: Electrical .....	5
Fan Speed: Air Volume Flow Rate .....	6
3. PACKAGE CONTENTS & TOOLS REQUIRED .....	7
4. INSTALLATION .....	8
Low Pressure Hot Water [LPHW] Models .....	11
5. ACCESS FOR ELECTRICAL CONNECTION .....	11
6. WIRED-REMOTE CONTROL INSTALLATION .....	12
7. REMOTE CONTROL SETTINGS .....	12
8. EXTERNAL CONTROLS .....	13
9. MULTIPLE AIR CURTAIN SYSTEMS .....	14
10. SYSTEM CONFIGURATION .....	15
11. REMOTE CONTROL OPERATION .....	16
12. COMMISSIONING THE SYSTEM .....	17
13. SIGN OFF .....	17
14. FAULT CONDITIONS .....	18
15. SERVICE & MAINTENANCE .....	19
16. WARRANTY .....	20
APPENDIX 1 — Dimensions: 2000R Series Surface Mounted Air Curtain .....	21
APPENDIX 2A — WIRING DIAGRAM 2047EHR and 2063EHR 208V .....	22
APPENDIX 2B — WIRING DIAGRAM 2083EHR 208V .....	23
APPENDIX 2C — WIRING DIAGRAM 2047EHR and 2063EHR 480V or 600V .....	24
APPENDIX 2D — WIRING DIAGRAM 2083EHR 480V or 600V .....	25
APPENDIX 2E — WIRING DIAGRAM 2047WHR, 2063WHR and 2083WHR .....	26
APPENDIX 2F — WIRING DIAGRAM 2047R, 2063R and 2083R [NO HEAT] .....	27

## 1. ELECTRICAL SAFETY

**Danger: Disconnect ALL electrical supplies before servicing**

### Electrical Supply and Wiring to the Air Curtain

All electrical wiring and connections MUST be carried out by a competent qualified electrician in accordance with the latest edition of local and national electrical codes and regulations and/or local statutory regulations.

- In accordance with Local and/or National Electrical Codes, a 1 phase or 3 phase local disconnect [field supplied by others] with a contact separation of at least 1/8 inch [3mm] on all poles, must be fitted in the electrical supply to the air curtain and located in an accessible position adjacent to the unit. Units with dual electrical supplies (see \* in Table below) must have a common disconnect to switch off both supplies simultaneously.
- The appliance must be connected by wires/cables having an appropriate heat resistant temperature rating.
- All supply wiring, circuit breakers and other electrical installation equipment must be correctly sized for the air curtain model being installed; see Section 2: Specifications.
- Models with heating elements requiring a 480V or 600V, 3 phase electrical supply - see Section 2: Specifications, Electrical Supply – also need a separate 208V to 240V electrical supply to operate fan motors and controls.
- A 1 inch [25mm] cable or conduit connector of IP21 rating should be used for the connection of Electrical Supply into the air curtain.
- See Wiring Diagrams for connecting electrical supply and control cables to the air curtain.
- The air curtain must be grounded.

**2. SPECIFICATION TABLES 1, 2, & 3** [for unit dimensions refer to Appendix 1]

**Electrical Specifications**

Table 1

<b>Air Curtain Model</b>	<b>Electrical Supply (V/ph/Hz)</b>	<b>Rated Electrical Power Input (kW)</b>	<b>Rated Current per phase (amps)</b>	<b>Heat Output [Low/High] (kW)</b>	<b>Unit Weight lb [kg]</b>
2047R	208...240/1/60	0.12	0.5	–	42 [19]
2063R	208...240/1/60	0.16	0.7	–	55 [25]
2083R	208...240/1/60	0.23	1.0	–	77 [35]
2047WHR	208...240/1/60	0.12	0.5	3.0 / 6.0	49 [22]
2063WHR	208...240/1/60	0.16	0.7	4.5 / 9.0	66 [30]
2083WHR	208...240/1/60	0.23	1.0	6.0 / 12.0	90 [41]
2047EHR (208V)	208/3/60	8.8	24.5	4.3 / 8.6	44 [20]
2063EHR (208V)	208/3/60	11.7	32.7	5.8 / 11.5	60 [27]
2083EHR (208V)	208/3/60	17.5	49.0 **	8.6 / 17.3	82 [37]
2047EHR (480V)	480/3/60 * + 208...240/1/60	9 0.12	10.9 0.5	4.5 / 9.0	44 [20]
2063EHR (480V)	480/3/60 * + 208...240/1/60	12 0.16	14.5 0.7	6.0 / 12.0	60 [27]
2083EHR (480V)	480/3/60 * + 208...240/1/60	18 0.23	21.7 1.0	9.0 / 18.0	82 [37]
2047EHR (600V)	600/3/60 * + 208...240/1/60	9 0.12	9.3 0.5	4.5 / 9.0	44 [20]
2063EHR (600V)	600/3/60 * + 208...240/1/60	12 0.16	12.8 0.7	6.0 / 12.0	60 [27]
2083EHR (600V)	600/3/60 * + 208...240/1/60	18 0.23	18.6 1.0	9.0 / 18.0	82 [37]

**NOTE:**

\* These models require a separate electrical supply for heaters [480 / 600V] and fan motors [208 / 240V]

\*\* Electric heater circuit current = 47.9 Amps

## Fan Speeds: Air Volume Flow Rate

Factory settings for the 3 fan speeds are indicated in Tables 2 and 3 below:

### Fan powered 208V (refer to wiring diagrams in Appendix 2)

Table 2

Fan Speed	Max. Air Velocity at Outlet Grille ft/min [m/s]	Maximum Air Curtain Mounting Height ft [m]	Sound Pressure Level dB(A) at 10ft [3m]	Air Volume Flow Rate / cfm [m <sup>3</sup> /h]
<b>HIGH</b> (black wire)	1475 [7.5]	8ft 6in [2.6]	2047R – 54 2063R - 54 2083R - 55	660 [1125] 955 [1620] 1325 [2250]
<b>MEDIUM</b> (blue wire)	–	–	2047R - 50 2063R - 50 2083R - 51	655 [1115] 940 [1600] 1310 [2225]
<b>LOW</b> (red wire)	–	–	2047R - 45 2063R - 45 2083R - 46	575 [975] 825 [1405] 1150 [1950]

### Fan powered 230V (refer to wiring diagrams in Appendix 2)

Table 3

Fan Speed	Max. Air Velocity at Outlet Grille ft/min [m/s]	Maximum Air Curtain Mounting Height ft [m]	Sound Pressure Level dB(A) at 10ft [3m]	Air Volume Flow Rate / cfm [m <sup>3</sup> /h]
<b>HIGH</b> (black wire)	1575 [8.0]	9ft 10in [3.0]	2047R - 55 2063R - 55 2083R - 56	740 [1250] 1060 [1800] 1470 [2500]
<b>MEDIUM</b> (blue wire)	–	–	2047R - 53 2063R - 53 2083R - 54	670 [1140] 965 [1640] 1340 [2275]
<b>LOW</b> (red wire)	–	–	2047R - 50 2063R - 49 2083R - 50	605 [1025] 870 [1475] 1205 [2050]

Sound pressure levels dB(A) at 3m/10ft distance are for a single air curtain mounted at its maximum mounting height, operating in a room with average acoustic characteristics as defined in CIBSE Guide B5 (reverberation time 0.7s at 1kHz) and a room size equivalent to 8 air changes per hour (ac/h). Care needs to be taken when selecting air curtains for an installation as noise levels can be several dB higher if the mounting height is reduced, if the room is more 'live' (i.e. hard surfaces, no furnishings or absorbent materials), if the room is smaller than 8 ac/h equivalent or a combination of these factors. Noise levels will also increase if more than one air curtain is installed at the same doorway (e.g. +3dB(A) for 2 equal point sources: direct field).

### 3. PACKAGE CONTENTS

**NOTE:** If any parts are missing or damaged during shipment, make note on bill of lading and contact your place of purchase immediately.

The following items are supplied in the box at delivery.

#### 2000R Recessed Air Curtain



#### Wired-Remote Control



Supplied with 20 ft. [6m]  
RJ Control Cable

#### Door Switch



2047R, 2063R: x1  
2083R: x2

#### Recessed Grille



The Recessed Grille  
is supplied separately

#### 3-port control valve [water heated units]



Fitted in pipework  
by installer

#### Outdoor Air Thermostat [Optional – field supplied]



Simple weather compensation  
control [disables heating on  
warmer days]

#### Tools required for installation:

- Flat blade screwdrivers
- Phillips head screwdrivers
- 10 mm wrench
- Level
- Adjustable wrench
- Tools to cut ceiling aperture
- Electric Drill
- Ladders
- Appropriate lifting equipment

## 4. INSTALLATION

This air curtain is designed to be recessed within ceiling voids or bulkheads inside a building and located horizontally over a doorway. It must not be installed outside of the building, and must be operated at temperatures above 21°F [-6°C]. Condensation forming in or on the unit may result in reduced life expectancy.

**WARNING:** It is the sole responsibility of the installer to ensure that the fixing locations and field supplied suspension system used are suitable for the air curtain being installed.

### 4.1 Location

Mount the air curtain above and as close to the doorway opening as possible:

- The recessed grille not more than:
  - 208v operation: 8ft 6in [2m] above floor
  - 230v operation: 9ft 10in [3m] above floor
- The air discharge (see 1, Fig 1) section of the air curtain and recessed grille closer to the doorway and the air inlet section (see 2, Fig 1) further from the doorway

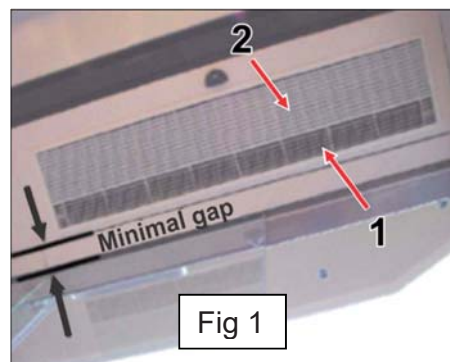

Beware of doorway top edges, structural beams, door opening/closure devices, etc., which may interfere with the air stream and affect the location of the unit.

**NOTE:** For the air curtain to work effectively the width of the open doorway should be less than the width of the airstream.

### 4.2 Ceiling Suspension

5/16" UNC Threaded Rods (field supplied) are used to suspend the unit from the ceiling.

**Step 1** Cut an aperture in the ceiling to the dimensions in Appendix 1 Table. If necessary, cut notches to clear screws in the air curtain casing.

**Step 2** Fix 5/16" UNC threaded rods (field supplied) through the 2 holes at each end in the top casing (see Fig 2). Feed the rods through the casing and attach to fixing brackets near the bottom of the unit (see Fig 3, looking up into the air curtain). Use 5/16" lock-nuts either side of the fixing brackets to secure the hanging rods.



**NOTE:** Do not let the hanging rods extend below the bottom of the unit casing so they cannot interfere with the proper fit of the recessed grille.

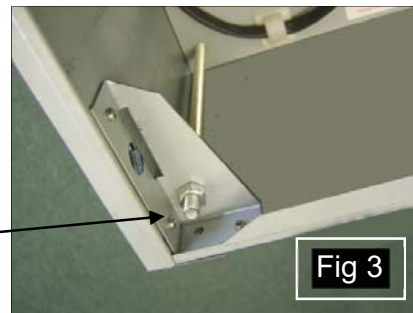



**NOTE:** For LPHW models, pipework will need to be installed above the curtain. Allow sufficient access and height clearance within the ceiling space to do this.

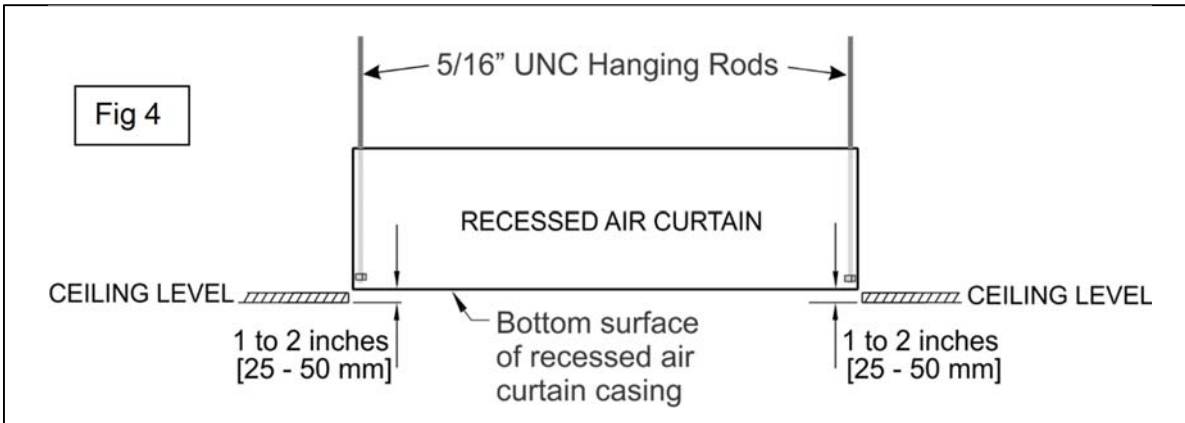

**Step 3** Secure each suspension rod suitably to the structure (field supplied hardware) to support the weight of the unit (see Section 2: Table 1: Specifications for weight).

**Step 4** Adjust the height of the unit on the hanging rods so the bottom surface of the casing is between 1 to 2 inches [25-50mm] up into the ceiling as shown in Fig 4. Ensure the unit is level.

#### 4.3 Attach the recessed grille to the air curtain

The recessed grille consists of:

- Metal frame
- Hinged inlet / discharge grille
- Slotted mounting brackets

There are 4 slotted mounting brackets on the 2047R and 2063R, and 6 brackets on the 2083R (see Fig 5).

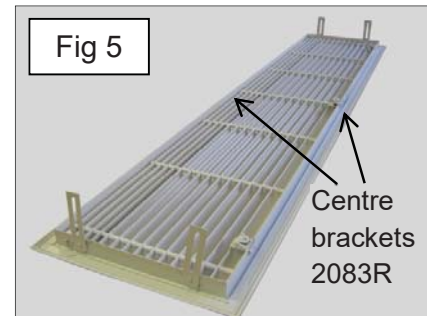

Attach the grille to the unit as follows:

**Step 1** Open the hinged inlet grille using a flat bladed screwdriver to release the fasteners (see Fig 6). There are two fasteners on the 2047R unit and three fasteners on 2063R and 2083R units. Before lifting the grille frame into position, remove the four (six on 2083R) M6 bolts fitted on the inside edge of the air curtain.

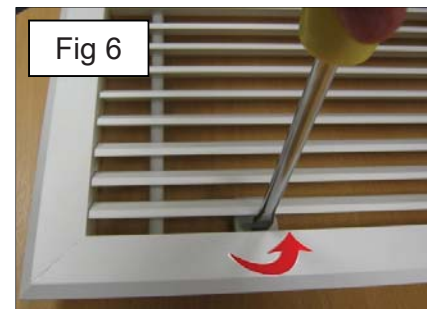

**Step 2** Ensure the grille is in the correct orientation with discharge closer to doorway.  
Insert the grille frame up through the cut-out in the ceiling.

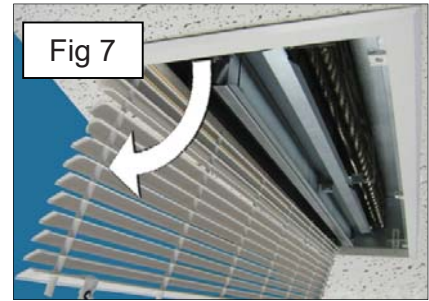

**Step 3** Using the M6 bolts removed in Step 1, secure the grille frame by fixing each bolt through the slotted brackets as shown in Fig 8.

With the hinged grille open, adjust the height of the grille frame via slots in each bracket, so the frame is snug fit against the ceiling with no gaps all around.

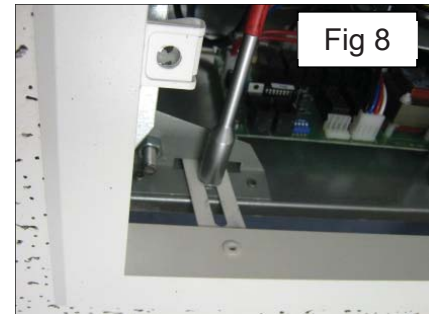

**Step 4** To prevent discharge air re-circulating within the air curtain, the sliding separator plate will need adjustment up or down (see Fig 9). To adjust plate release M6 bolts either end, extend the slide plate so that it will touch the topside of the grille along its entire length and tighten the bolts. It will be necessary to close the hinged grille to gauge where the separator plate should be adjusted.



**Step 5** Once the adjustments above are complete the hinged grille can be closed and all the fasteners tightened.

**NOTE: Access to electrical connections:**

Open the hinged grille to gain access to electrical, servicing, and maintenance.



#### 4.4 Low Pressure Hot Water [LPHW] Models

For LPHW models ensure that isolation valves [field supplied by installer] are fitted in the supply and return pipework adjacent to the air curtain and connected correctly as shown in Figure 11 below and Appendix 1.

For the design of the pipework system and pump, flow rates and pressure drops for maximum heat output of the air curtain are indicated in Table 4.

Table 4

Air Curtain	Water Flow Rate US Gal/min at 180-160°F [ l/min at 82-71°C ]	Water Pressure Drop psi ( ft H <sub>2</sub> O ) [ kPa ]
2047WHR: 1-row (6kW)	2.1 [7.8]	0.74 (1.7) [5.1]
2063WHR: 1-row (9kW)	3.1 [11.7]	1.58 (3.6) [10.9]
2083WHR: 1-row (12kW)	4.1 [15.6]	2.86 (6.6) [19.7]

**NOTE:** Water Pressure Drop is across the supply and return pipework to the air curtain and includes the coil fitted inside the unit and the valve fitted in the pipework to the unit.  
Water flow rates and pressure drops at different water temperatures can be calculated using the SchwankAir coil calculation program. Visit the Schwank website for details.

**Note:** The installer must connect the 3-port valve in the hot water piping as shown below in Figure 11.

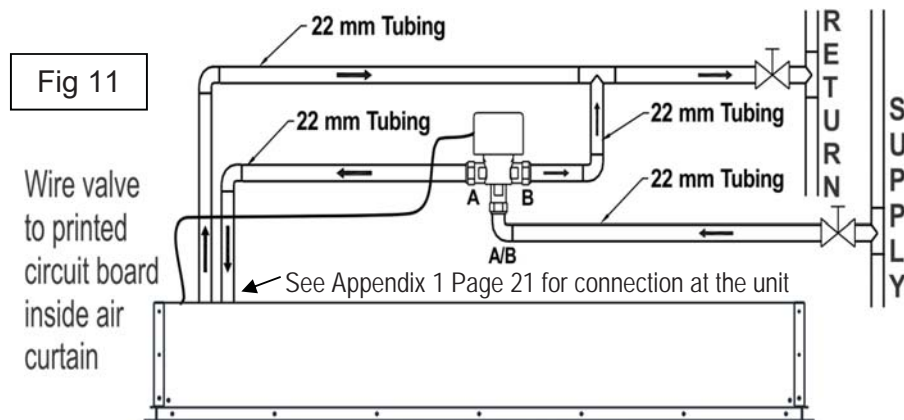

## 5. ACCESS FOR ELECTRICAL CONNECTION

### 5.1 How to access terminals

To gain access to the air curtain for electrical connection and commissioning, use a flat bladed screw driver to release the fasteners (two on 2047R and three on 2063R and 2083R), and open the hinged air grille. [refer to Section 4.3, Step 1 above]

## 6. WIRED REMOTE CONTROL INSTALLATION

Mount the wired-remote control in a convenient location directly to the wall or onto a switch box. The RJ cable from the remote control plugs directly to one of the receptacles on the printed circuit board (route wire into unit through top). The other receptacle can be used for the control of multiple units with one remote control (see Section 9 below).

### 6.1 Wall mounting

**Step 1** Undo the screw on the top of the remote control case and pull the back case away (see Fig 12).

**Step 2** Feed one end of the RJ control cable through the back case, secure it, then screw the back case to the wall using suitable hardware (field supplied).

**Step 3** Connect the RJ plug to the RJ socket on the PCB in the remote control.

**Step 4** Refit the front case.

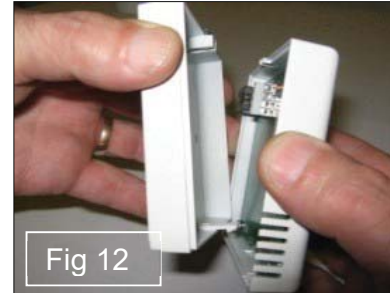

Fig 12

### 6.2 Switch box mounting

**Step 1** Using a screwdriver undo the screw on the top of the remote control case and pull the back case away (see Fig 12).

**Step 2** Feed one end of the RJ control cable through the switch box, feed and secure the RJ control cable through the back case and secure back case to switch box using 2 mounting screws (field supplied) (see Fig 13).

**Step 3** Connect the RJ plug to the RJ socket on the PCB in the remote control.

**Step 4** Refit the front case.

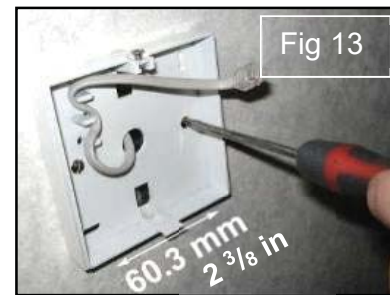

Fig 13

## 7. REMOTE CONTROL SETTING OPTIONS

On the back of the printed circuit board (PCB) inside the Wired-Remote Control are four DIP switches that provide the following optional features (Table 5):

Table 5

DIP	Feature	Explanation	Default	Notes
1	Reset on power-up	On restoring power after an electrical interruption all Remote Control settings are retained	ON	<b>WARNING!</b> – Fans start automatically after power is restored
2	Stop fan on cold	Fans are switched off when heating level is achieved (AUTO mode only)	OFF	
3	Never blow cold	Air curtain always heats in AUTO mode	OFF	Will not go to ambient mode
4	Room air temperature control	Enables the room air sensor in the Remote Control	OFF	Disables all other temperature sensors

## 8. EXTERNAL CONTROL OPTIONS

### 8.1 Remote switch contacts IN0, IN1

Terminals IN0 and IN1 on the printed circuit board (PCB) inside the air curtain can be used to provide different control strategies using remote dry contacts (see Fig 14). (Unit ships with jumper wires in place). This could be to provide remote On/Off from a timer or BMS Digital/Output contact, a door switch, or for simple weather compensation control to disable heating when outdoor air temperature becomes warmer.

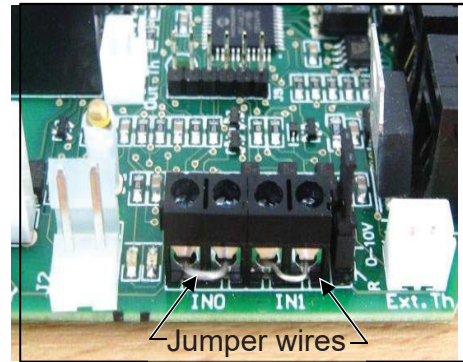

Fig 14

Table 6 describes the different functions available:

**WARNING:** Do not apply any voltage to dry contact terminals IN0 and IN1. Voltage will damage the printed circuit board.

Table 6

Function	IN0		Notes		
	Closed	Open			
Remote On/Off (INHIBIT)	Unit operates normally in MANUAL Mode or AUTO Mode from the Remote Control	Unit switches off after 15 sec, with fan run-on at Medium fan speed if DIP 2 = OFF	Use the Remote Control to set up unit and then hide it away if required.* On/Off is then done via IN0 using a remote volt-free contact.		

Function	IN1		DIP 4	IN0	Notes
	Closed	Open			
Door Switch Control	After 30 sec the heating is disabled and the fan goes to low speed	Unit operates normally in MANUAL Mode or AUTO Mode from the Remote Control	ON	Closed	Door Open: Normal Control Door Closed: Heating Off Low Fan Speed
Summer Winter	Unit operates normally in MANUAL Mode or AUTO Mode from the Remote Control <i>COLD DAY</i>	Heating is disabled Fan speeds operate normally from the Remote Control <i>WARM DAY</i>	OFF	Open	Simple weather compensation control using an outdoor air thermostat with volt free contacts (see Section 11.3)

**NOTE:** Wire remote switch dry contacts to 2-way screw terminals IN0 and IN1 using 2-core cable.

\* **NOTE:** The Wired-Remote Control must stay plugged-in for the air curtain to operate. An optional plug-in EEPROM is available from Schwank so the Remote Control can be un-plugged and the air curtain continue operating. Visit the Schwank website for details.

### 8.2 Overheat safety cut-out indication

For electric heated air curtains the PCB includes a fault indication signal if the overheat safety cut-out on the electric heater operates.

Changeover dry contacts (6A 250VAC 30VDC) can be wired via the 3-way screw terminal “HEALTHY” (see Fig 15).

Refer to Section 14.1: ‘Overheat safety cut-out’ for instruction on how to reset an overheat safety cut-out condition.

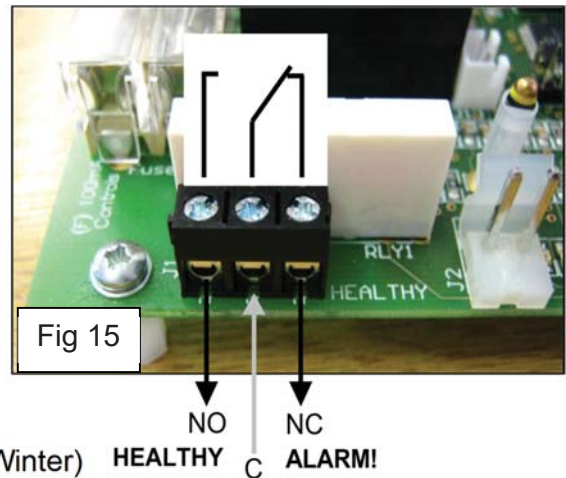

### 8.3 Weather compensation control (Summer/Winter)

To save heating energy on warmer days a simple weather compensation (Summer/Winter) heat control strategy can be used. Fit an outdoor air thermostat with dry contacts (supplied by the installer) to a north facing wall.

Use a 2-core wire to connect the outdoor air thermostat to 2-way terminal IN1 on the PCB (see Fig 16)

On the air curtain PCB, set DIP 4 to OFF per Table 5, (see Section 8.1: Remote switch contacts IN0, IN1).

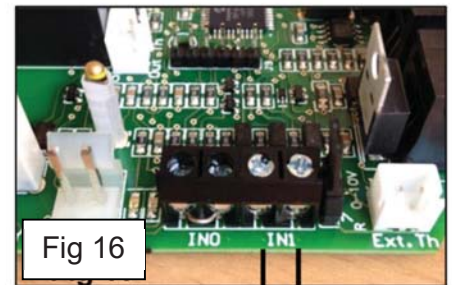

**WARNING:** Do not apply any voltage to terminal IN1 as this will damage the PCB.

Switch Contact  
 Cold Day: Closed = Heating Enabled  
 Warm Day: Open = Heating Disabled

Outdoor Air Thermostat

**NOTE:** To promote increased energy saving a more advanced weather compensation control strategy is available from SchwankAir. Using a heating curve, the discharge air temperature of the airstream coming from the air curtain is controlled against the outside air temperature. Visit the Schwank website for details.

## 9. MULTIPLE AIR CURTAIN SYSTEM CONTROLLED BY SINGLE WIRED-REMOTE

- Each air curtain must have its own individual electrical supply, but up to 8 units can be controlled by a single wired-remote control
- Each air curtain is supplied with a remote control with 20 ft [6m] RJ cable connected
- Install first remote control RJ cable to the printed circuit board (PCB) of the first unit
- Disconnect the RJ cable(s) from control(s) shipped with the additional unit(s)
- Connect a maximum of 8 units together by plugging the RJ extension cable on to one of the PCB receptacles of one unit then into the next consecutive unit

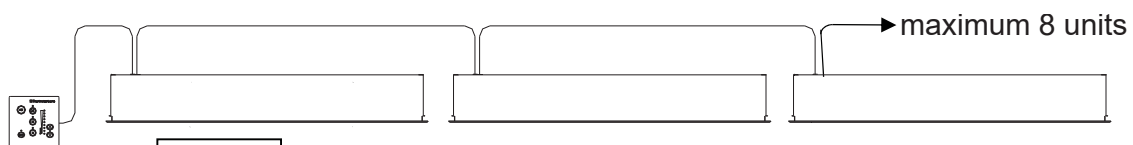

Fig 17

## 10. SYSTEM CONFIGURATION

### Optional features

**WARNING:** Isolate and disconnect air curtain from the power source before making any changes.

DIP switches on the air curtain PCB (see Fig 18) provide the following optional features, as explained below:

- Fan heat interlock
- Disable fan run-on
- Thermostat master (for master/slave installations)
- Weather compensation heat control (Summer/Winter)
- Door switch control



Fig 18

Feature	DIP Setting	Default	Notes
<p><b>Fan heat interlock</b> Allows fan speed to govern heat output on electric heated units.</p> <p>If low or medium fan speed is selected, a lower heat output results. High heat operates only on high fan speed.</p>	<p><b>DIP 1</b></p> <p>ON</p> <p>1 2 3 4</p>	<p><b>ON</b></p> <p>Heat output is governed by fan speed.</p>	<p>This feature is only used with electric heated air curtains to limit very high air temperatures.</p> <p>Set DIP1 to OFF if unit is water heated or ambient.</p>
<p><b>Disable fan run-on</b> The 2-minute fan run-on after switch off is enabled or disabled on electric heated air curtains.</p>	<p><b>DIP 2</b></p> <p>ON</p> <p>1 2 3 4</p>	<p><b>OFF</b></p> <p>Fan run-on at medium speed enabled.</p>	<p>Must only be used for water heated or ambient air curtains. Each air curtain must have DIP2 set to ON for no fan run-on.</p>
<p><b>Thermostat master</b> For master/slave installations. Only the air sensor in the thermostat master air curtain is used to measure air temperature.</p> <p>Set DIP 3 to ON in the air curtain that will be the master unit.</p>	<p><b>DIP 3</b></p> <p>ON</p> <p>1 2 3 4</p>	<p><b>OFF</b></p> <p>Air curtains in master/slave systems all act independently.</p>	<p>Air sensor thermistors in all slave air curtains will be ignored.</p> <p>Stops some units blowing cold air and others blowing warm air in master/slave systems on larger doorways.</p>
<p><b>Weather compensation control <u>or</u> Door switch control</b></p> <p>Simple weather compensation control to save heating energy.</p> <p><b>or</b> Door switch control.</p>	<p><b>DIP 4</b></p> <p>ON</p> <p>1 2 3 4</p>	<p><b>OFF</b> IN1 Weather compensation</p> <p><b>ON</b> IN1 Door switch</p>	<p>See section 8.1 Remote Switch Contacts IN0 and IN1 for details</p> <p>Weather compensation control is the same as Summer/Winter control</p>

**NOTE:** The Black rectangle ■ is the moveable switch head of the DIP switch.

**NOTE:** A range of advanced factory fitted and plug-in control options are available from SchwankAir to enhance the performance of the air curtain PCB controller. These include advanced weather compensation control using a heating curve, outlet air temperature control, Modbus BMS control, modulating heater outputs and EEPROMs for non-standard control strategies. Visit the Schwank website for details.

## 11. WIRED-REMOTE CONTROL OPERATION

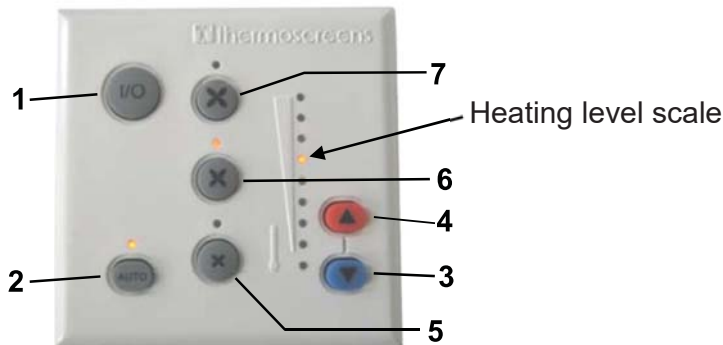

Use the Wired-Remote Control to operate the air curtain as follows:

### 1 On/Off

Turns the air curtain On or Off.

**NOTE:** If an electric heated air curtain is in the process of heating when switched off the fan will run-on for approximately 2 minutes to dissipate heat.

### 2 Manual/Automatic

Switches between Manual and Automatic modes.

The Auto On indicator LED is lit for "Auto Mode" and unlit for "Manual Mode".

### 3 & 4 Heating level controls

#### *Manual mode*

Select heating level from zero, to half heat, to full heat by stepping up or down with the heating level controls. The heating level scale shows the level selected.

#### *Automatic mode*

Heat output is controlled automatically according to:

- Inlet air temperature, or
- Room air temperature

This is dependent on the settings made in Section 10: Remote Control Settings - DIP switch 4.

### 5, 6 & 7 Fan speed

Switch fan speed between Low, Medium and High respectively. The appropriate LED illuminates.

**NOTE:** On Ambient (non-heated) units the LED indicators on the Heating level scale and AUTO button illuminate but are ignored.



## 12. COMMISSIONING THE SYSTEM

### 12.1 Verify system operation

To commission the system, verify the following conditions are met:

- All fans operate at Low, Medium and High speeds.
- There is no excessive mechanical noise coming from the fans.
- When heating is selected, the air stream from the discharge grille warms up across the whole length of the air curtain.
- When set to manual with fans set to high speed, heat level increases as higher heat is selected.
- Warm air reaches across the doorway with door open or closed.
- Wired-Remote Control operates correctly in both manual and auto modes.

### 12.2 Instruct customer and hand over Instruction Manual

**Before leaving the site, hand over the instruction manual to the customer/end user or their representative for safe keeping on file.**

**Explain** that any person operating the air curtain must be given supervision and instruction by the person responsible for their safety, concerning the safe use of the unit and to understand any hazards involved. Children and those with reduced physical, sensory or mental capabilities should not operate the air curtain.

**Recommend** that the doorway should be closed whenever possible but that during times of high pedestrian use it will become an ‘open doorway’. The air curtain then serves an essential purpose by saving energy and providing comfort to occupants.

**Explain** that the inlet grilles and air filters (if fitted) must be cleaned regularly and the unit serviced at schedule intervals – see Section 15: Service & Maintenance.

**NOTE: Leave these instructions with the customer/end user or their representative!!  
File these instructions for safe keeping and future reference.**

## 13. SIGN OFF

Complete the following once commissioning is completed:

INSTALLER		CUSTOMER	
Print Name		Print Name	
Signature		Signature	
Company		Company	
Date		Date	

## 14. FAULT CONDITIONS

### 14.1 Overheat Safety cut-out

An overheat fault in electric heated units may cause the overheat safety cut-out(s) to activate. This is indicated by flashing LEDs on the Remote Control and a red status LED on the PCB inside the air curtain.

Before resetting ensure there is adequate air flow from the air curtain and the unit has been commissioned as per section 12.

To reset an overheat safety cut-out condition:

**Step 1** Switch off the electrical supply to the air curtain.

**Step 2** Allow time for the air curtain to cool down, typically 10 minutes.

**Step 3** Switch on the electrical supply to the air curtain.

**Step 4** Press the Auto button on the Wired-Remote Control 4 times.

Air curtain heaters will then operate and after 30 seconds the LEDs on the remote control will stop flashing and the status LED on the PCB in the air curtain will flash green.

### 14.2 Fuses

In the event of an electrical fault internal electrical fuses may operate.

There are two 6.3A(T) internal fuses located in two DIN-rail fused terminals inside the air curtain. There are also two internal fuses located on the PCB inside the air curtain:

- Fuse 6.3A(T) supplies the fan motors within the air curtain
- Fuse 100mA(F) controls the circuitry of the PCB

### 14.3 Air Curtain PCB status indication

There is a status LED on the PCB inside the air curtain (See LED shown on Wiring Diagrams in the Appendix).

This indicates the status of the control system as follows:

1. LED flashing green – operation normal
2. LED flashing red – low supply voltage, remote control not plugged in or RJ cable fault
3. LED permanently red – overheat safety cut-out(s) open circuit from an overheat situation. Indicators on Wired-Remote Control also flash!  
(see Section 14.1: How to reset Overheat Safety Cut-out)

## 15. SERVICE & MAINTENANCE

**WARNING:** Failure to adequately maintain the unit and provide a suitable cleaning schedule will result in a loss of performance and reduced life expectancy of the air-curtain and possible overheating and fire risk with electric heated units.

### 15.1 Perform Every week

**NOTE:** Weekly maintenance can be carried out by the Cleaner or Janitor from floor level.

Turn off the air curtain to prevent entry of dust then clean the face of the recessed grille using a vacuum cleaner with an extension tube and brush.

### 15.2 Perform Every 3 months

**WARNING:** Before servicing, isolate and disconnect the air curtain from the electrical power.

**WARNING:** The following servicing and maintenance must be carried out by a competent electrician or a SchwankAir approved technician.

Clean and inspect the inside of the air curtain as follows:

**Step 1** Open the hinged inlet grille using a flat bladed screwdriver to release the fasteners (see Section 4.3, Step 1).

**Step 2** Clean and remove any build-up of dust and dirt within the air-curtain (inlet/outlet grilles, electric heaters, fan impellers, housings and motors) using a vacuum cleaner and soft brush.

**NOTE:** Build-up of dirt on fan impellers can cause vibration, noise and excessive wear on the motor bearings.

**Step 3** Check within the unit to ensure all electrical connections and crimped terminals are tight and that all wires/cables are in good condition.

Close and secure hinged grille after servicing. Reconnect electrical supply and test to ensure correct operation (see Section 12: Commissioning).

## **16. WARRANTY**

The Manufacturer warrants that this product is free from defects in material or workmanship under normal use and service subject to the terms of this document.

### **TWO YEAR WARRANTY**

Subject to the conditions and limitations stated herein, during the term of this limited warranty, we will supply any component part (at our option a new or repaired component part) of the heater as defined below, which the Manufacturer's examination determines to be defective in workmanship or material for a period of two (2) years from the date of installation, unless otherwise specified below. This warranty applies to the heater's original owner, and subsequent transferees and only if the unit is installed, operated, and maintained in accordance with the printed instructions accompanying the unit and in compliance with all applicable installation codes and good trade practices.

### **WHAT IS NOT COVERED**

The Manufacturer shall not be responsible for any expenses, including service, labor, diagnosis, analysis, material or transportation charges incurred during removal or reinstallation of this product, or any of its components or parts. All labor or service charges shall be paid by the owner. This warranty does not cover products improperly installed, misused, exposed to or damaged by negligence, accident, corrosive or contaminating atmosphere, water, excessive thermal shock, impact, abrasion, normal wear due to use, alteration or operation contrary to the owner's manual or if the serial number has been altered, defaced or removed. This warranty shall not apply if the electrical input to the product varies by more than  $\pm 10\%$  of the rated input on the rating plate. The Manufacturer shall not be liable for any default or delay in performance by its warranty caused by any contingency beyond its control, including war, government restrictions, or restraints, strikes, fire, flood, acts of God, or short or reduced supply of raw materials or products.

### **LIMITATIONS AND EXCLUSIONS**

This document contains all warranties made by the Manufacturer and may not be varied, altered or extended by any person. There are no promises, or agreements extending from the Manufacture other than the statements contained herein. THIS WARRANTY IS IN LIEU OF ALL WARRANTIES EXPRESSED OR IMPLIED, TO THE EXTENT AUTHORIZED BY THE LAWS OF THE JURISDICTION, INCLUDING SPECIFICALLY THE WARRANTIES OR MERCHANTABILITY OF FITNESS FOR A PARTICULAR PURPOSE.

It is understood and agreed that the Manufacturer's obligation hereunder is limited to repairing or replacing parts determined to be defective as stated above. In no event shall the Manufacturer be responsible for any alleged personal injuries or other special, incidental or consequential damages. As to property damages, contract, tort or other claim the Manufacturer's responsibility shall not exceed the purchase price paid for the product.

All replacement parts will be warranted for the unused portion of the warranty coverage period remaining on the applicable unit.

Some Authorities do not allow certain warranty exclusions or limitations on duration of warranty or the exclusions or limitations of incidental or consequential damages. In such cases, the above limitations or exclusions may not apply to you and are not intended to do so where prohibited by law. This warranty gives you specific legal rights. You may also have other rights which vary by jurisdiction.

#### **USA**

2 Schwank Way  
Waynesboro, GA 30830

#### **Canada**

5285 Bradco Blvd.  
Mississauga, ON L4W 2A6

Tel: 1-877-446-3727

Fax: 1-866-361-0523

[www.schwankgroup.com](http://www.schwankgroup.com)

[csr@schwankgroup.com](mailto:csr@schwankgroup.com)

[csr@infrasave.com](mailto:csr@infrasave.com)

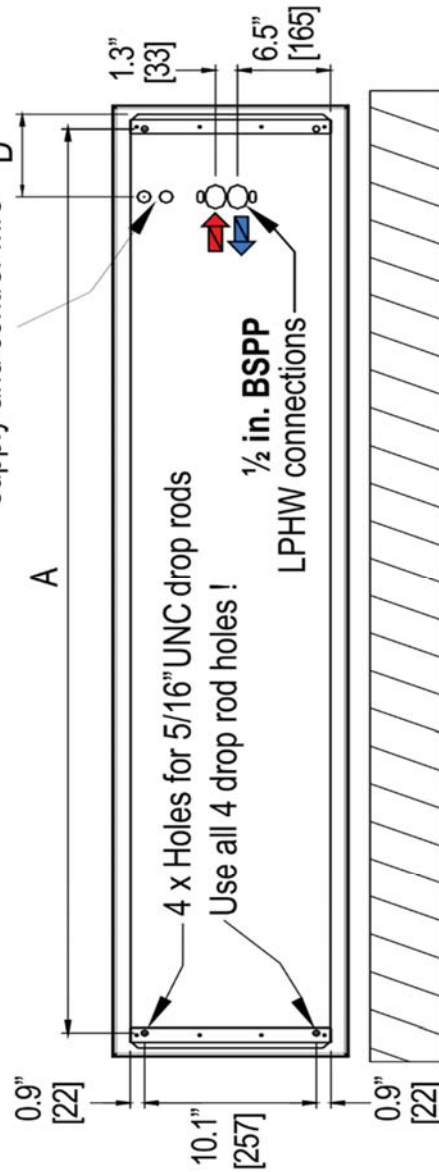
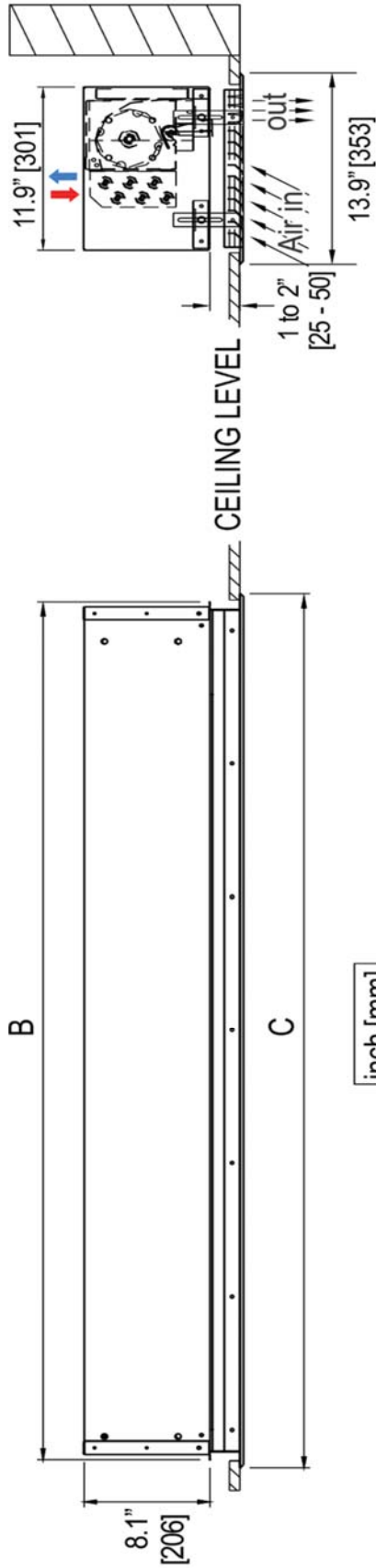
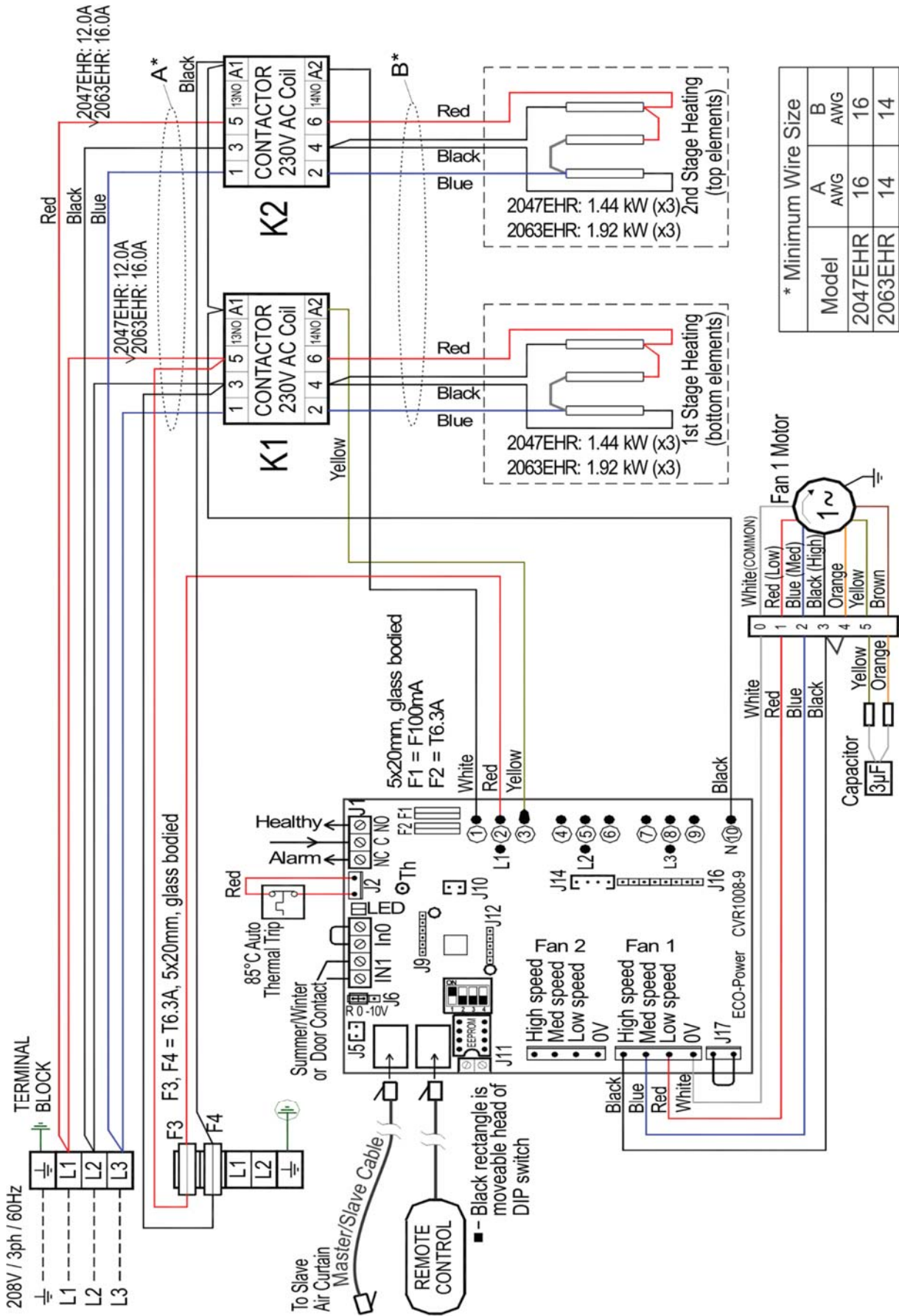

Table Values: Inches [mm]

	2047R	2063R	2083R
A	44.5 [1129]	60.2 [1529]	80.3 [2040]
B	46.4 [1179]	62.2 [1579]	82.3 [2090]
C	47.6 [1209]	63.4 [1609]	83.5 [2120]
D	5.5 [140]	5.5 [140]	5.9 [150]

	2047R	2063R	2083R
Length	46.4 [1179]	62.2 [1579]	82.3 [2090]
Ceiling Cut-out	11.9 [301]	11.9 [301]	11.9 [301]

## APPENDIX 1 — Dimensions of 2000R Series Recessed Air Curtain



APPENDIX 2A — WIRING DIAGRAM 2047EHR and 2063EHR 208V

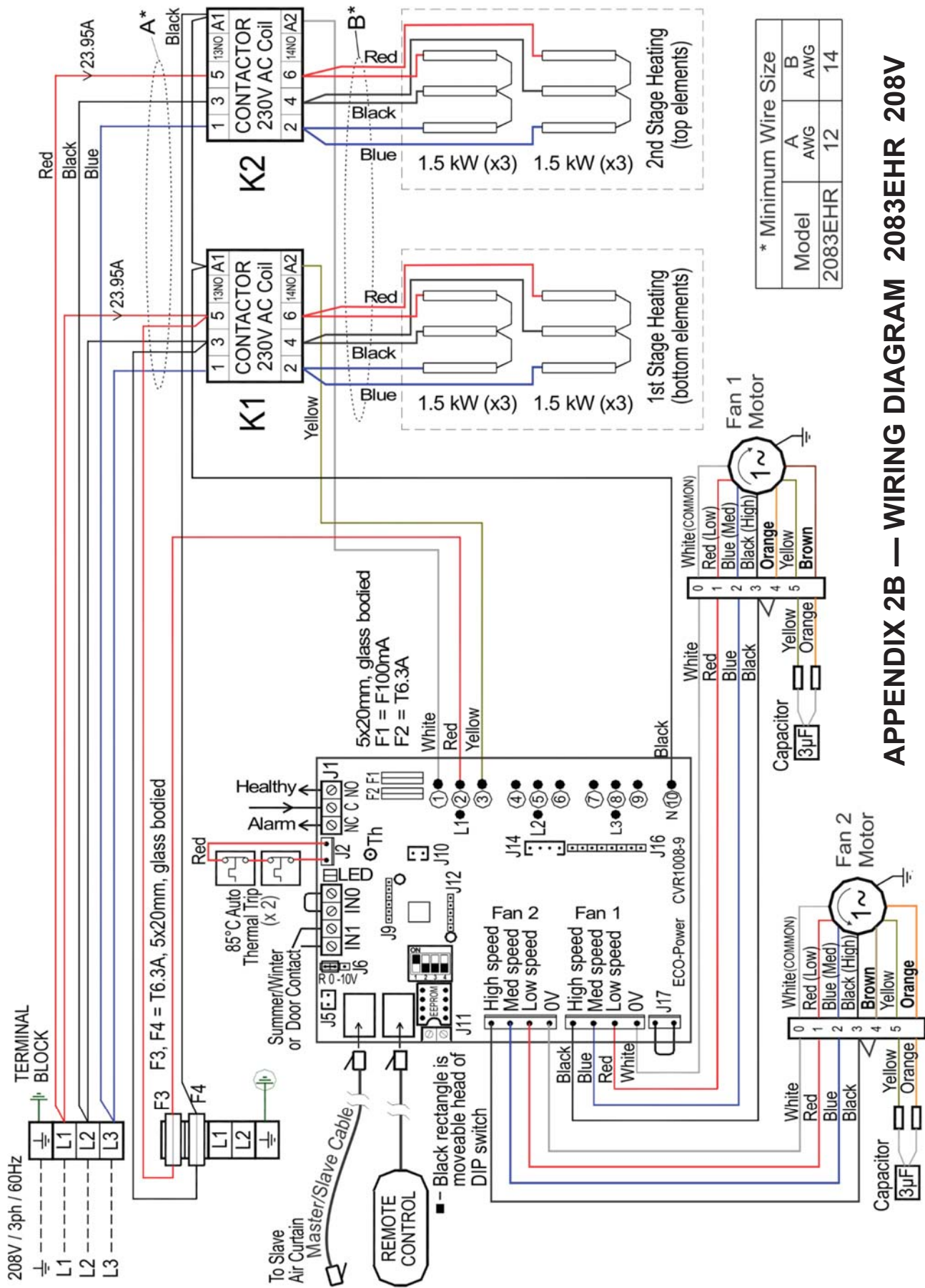

\* Minimum Wire Size

Model	A AWG	B AWG
2083EHR	12	14

**APPENDIX 2B — WIRING DIAGRAM 2083EHR 208V**

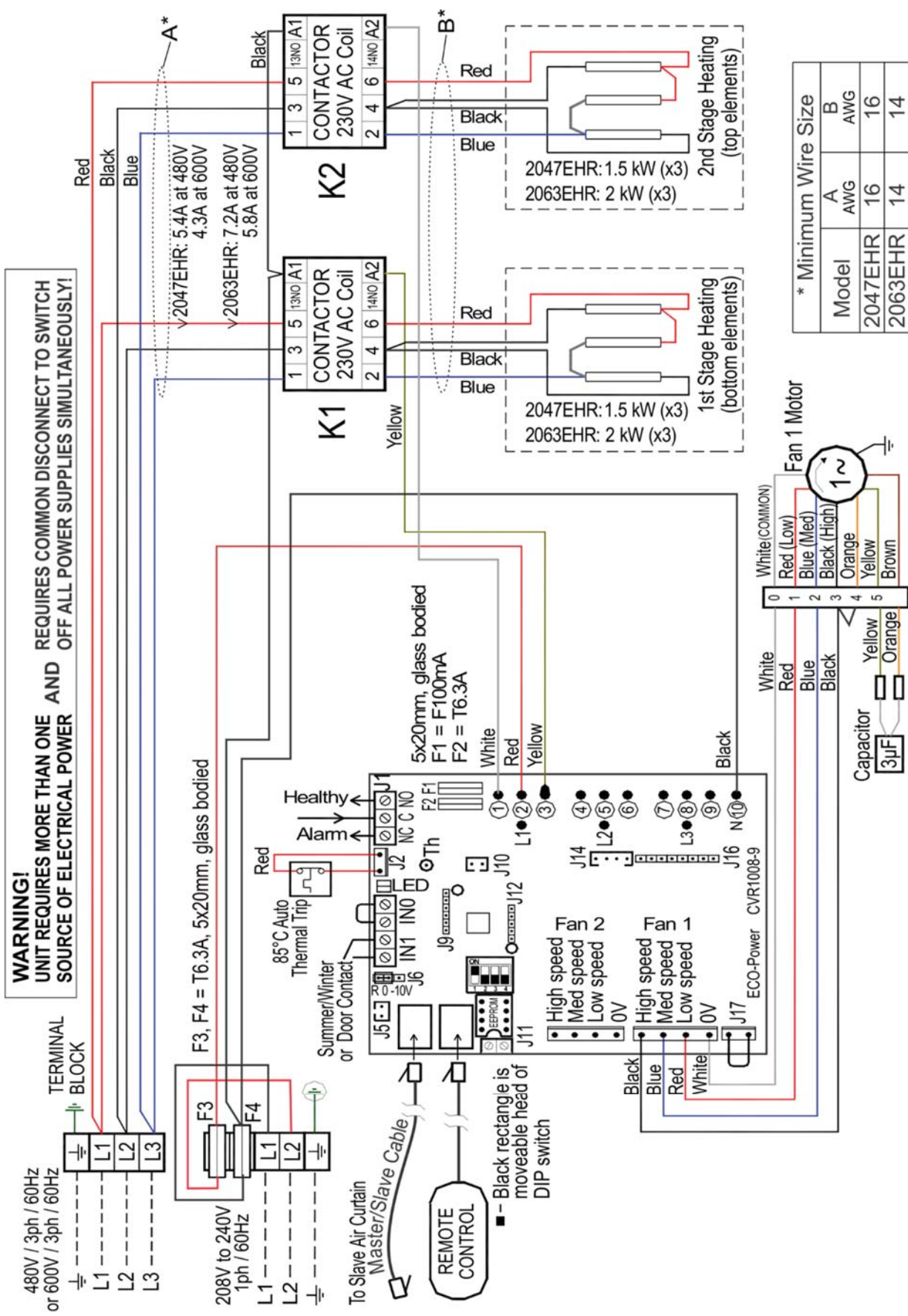

\* Minimum Wire Size

Model	A AWG	B AWG
2047EHR	16	16
2063EHR	14	14

APPENDIX 2C — WIRING DIAGRAM 2047EHR and 2063EHR 480V or 600V



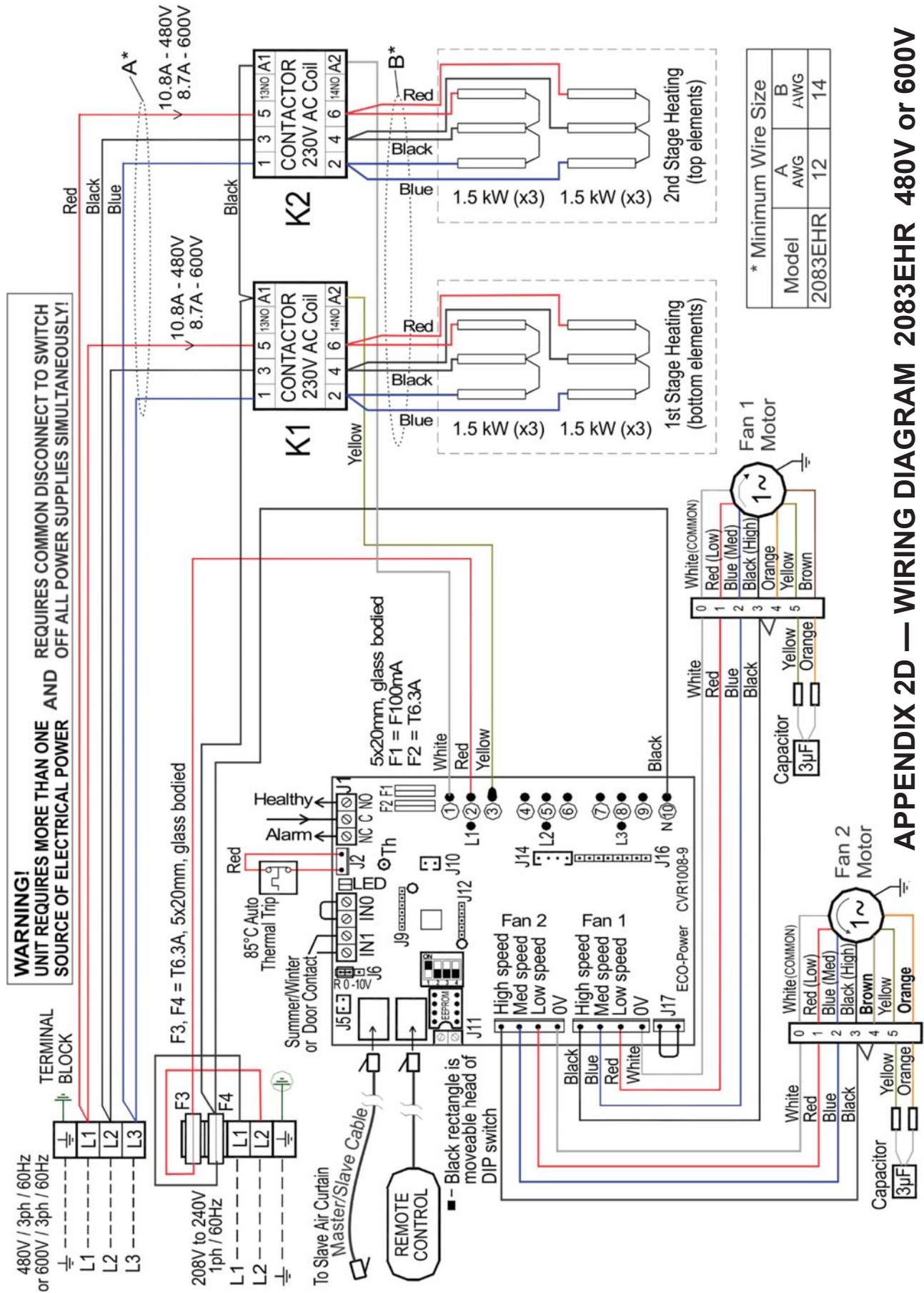

**APPENDIX 2D — WIRING DIAGRAM 2083EHR 480V or 600V**

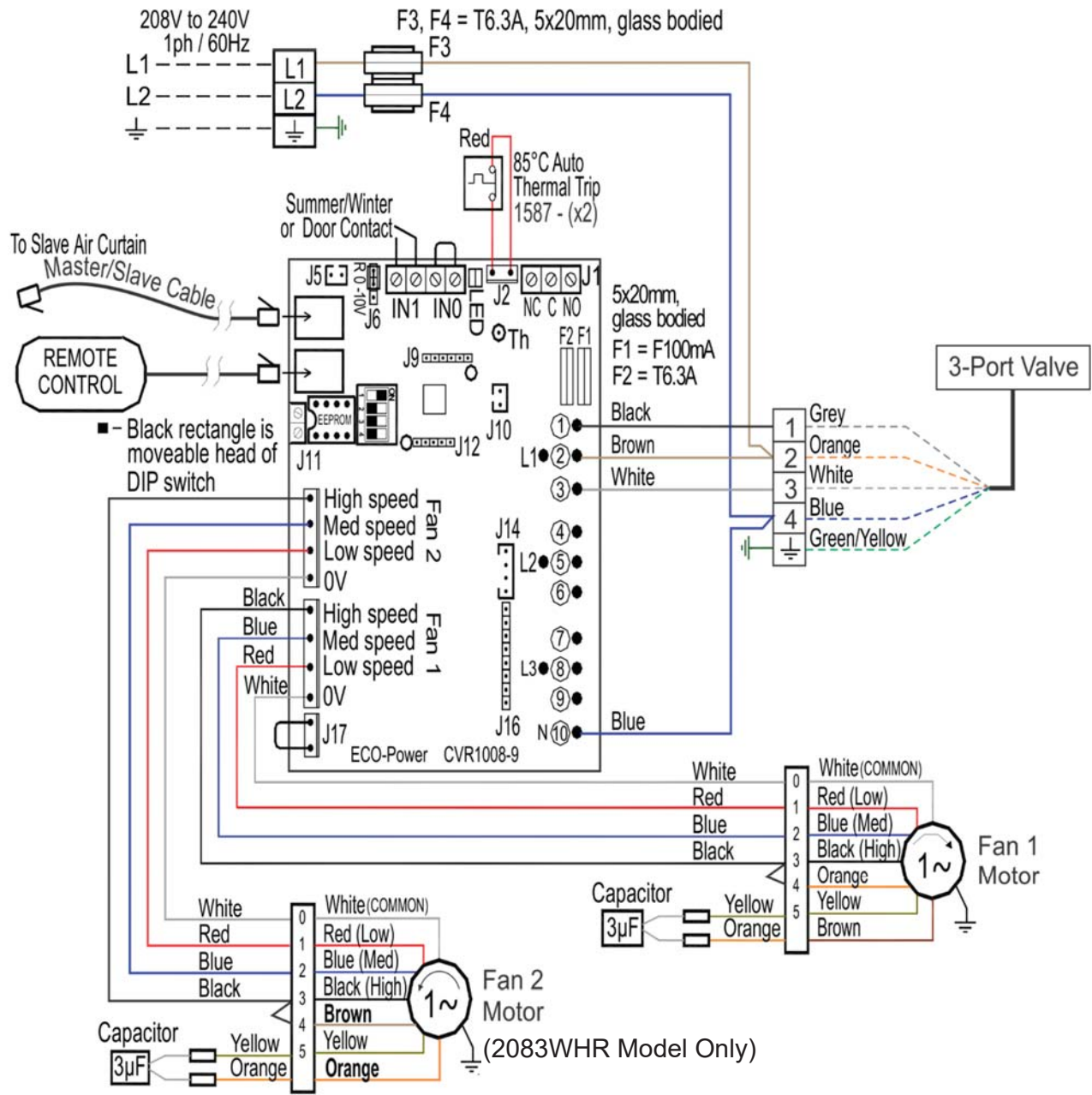

## APPENDIX 2E — WIRING DIAGRAM 2000WHR SERIES (Low Pressure Hot Water Heat)

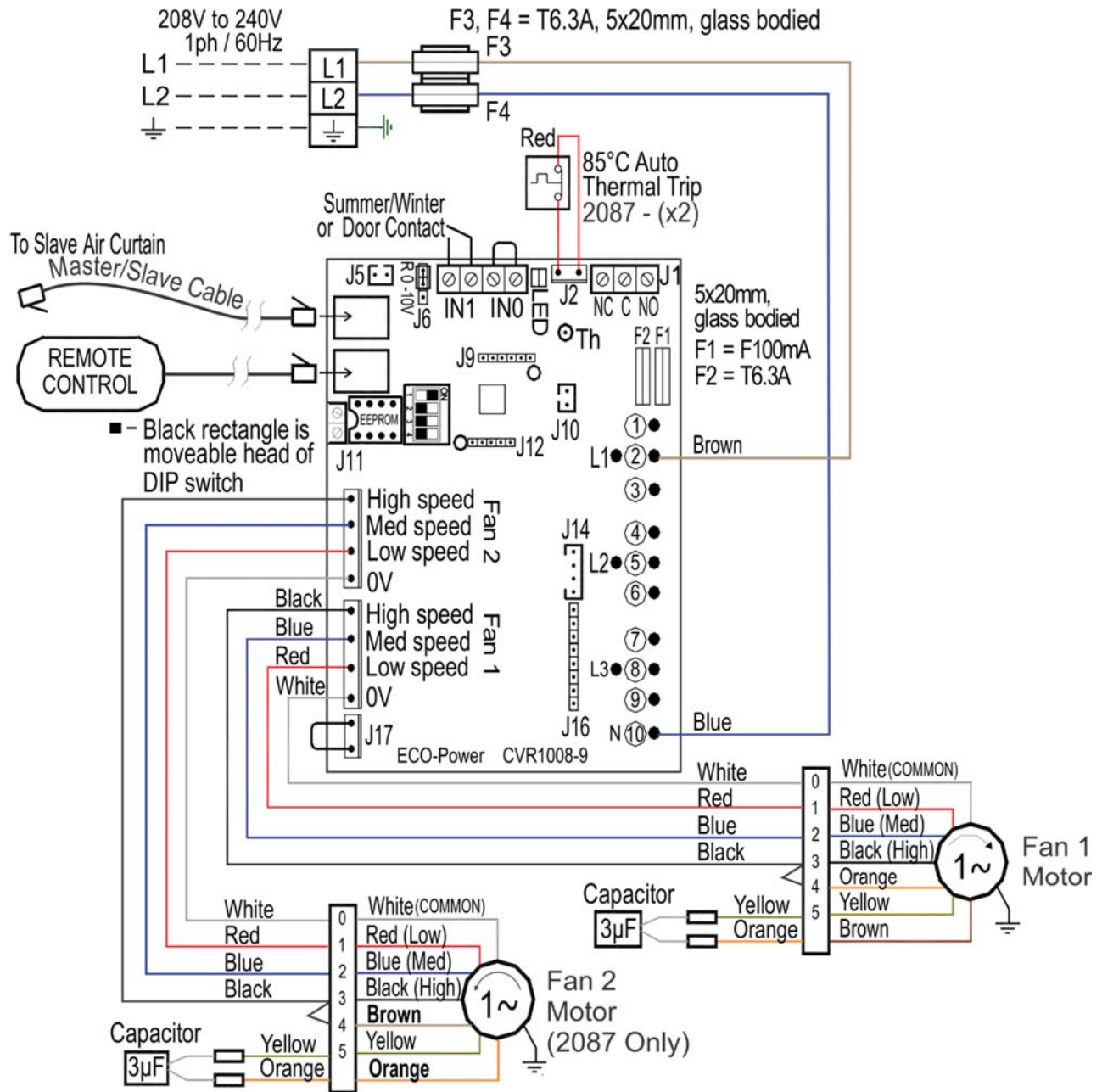

## APPENDIX 2F — WIRING DIAGRAM 2000R SERIES – NO HEAT