

| TECHNICAL SPECIFICATIONS |                                  |
|--------------------------|----------------------------------|
| VOLTAGE                  | 120 AC<br>60 Hz                  |
| WATTS                    | 1500 W Max                       |
| NO HEATER                | 25 W                             |
| MOTOR HEATER             | 19 W                             |
| APPLIANCE WIDTH          | 43 5/8" or 110.8 cm              |
| APPLIANCE HEIGHT         | 29 1/2" or 75 cm                 |
| APPLIANCE DEPTH          | 12 5/8" or 32.2 cm               |
| GROSS WEIGHT             | 94.6lbs or 43kg                  |
| PLUG LOCATION            | Left side                        |
| CORD LENGTH              | 70 7/8" or 180 cm                |
| ROUGH WALL OPENING       | 45"× 30" or<br>104.3 cm× 76.2 cm |
| BTU                      | 4800                             |

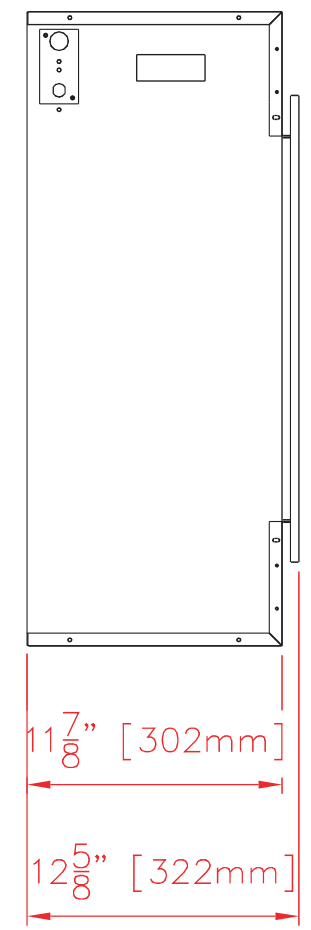

|                    |                            |   |              |
|--------------------|----------------------------|---|--------------|
| SERIES<br>Built-In | MODEL<br>45-XT - 102745-XT |  | REV<br>1     |
| SCALE 1" = 1'-0"   | DATE: 11/16/2017           |   | SHEET 1 OF 1 |

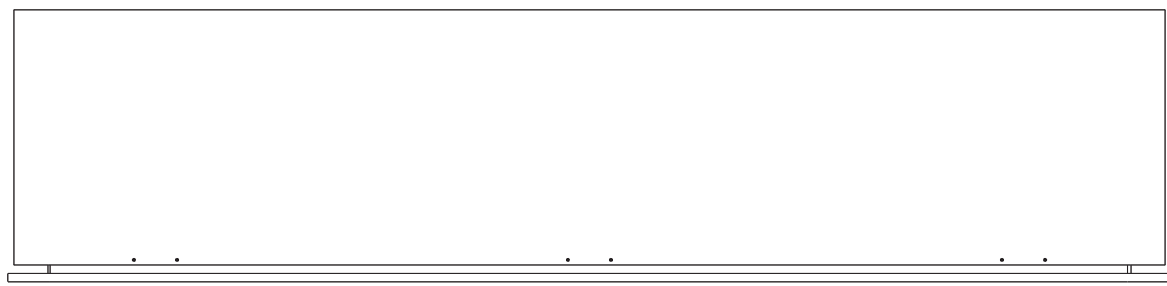
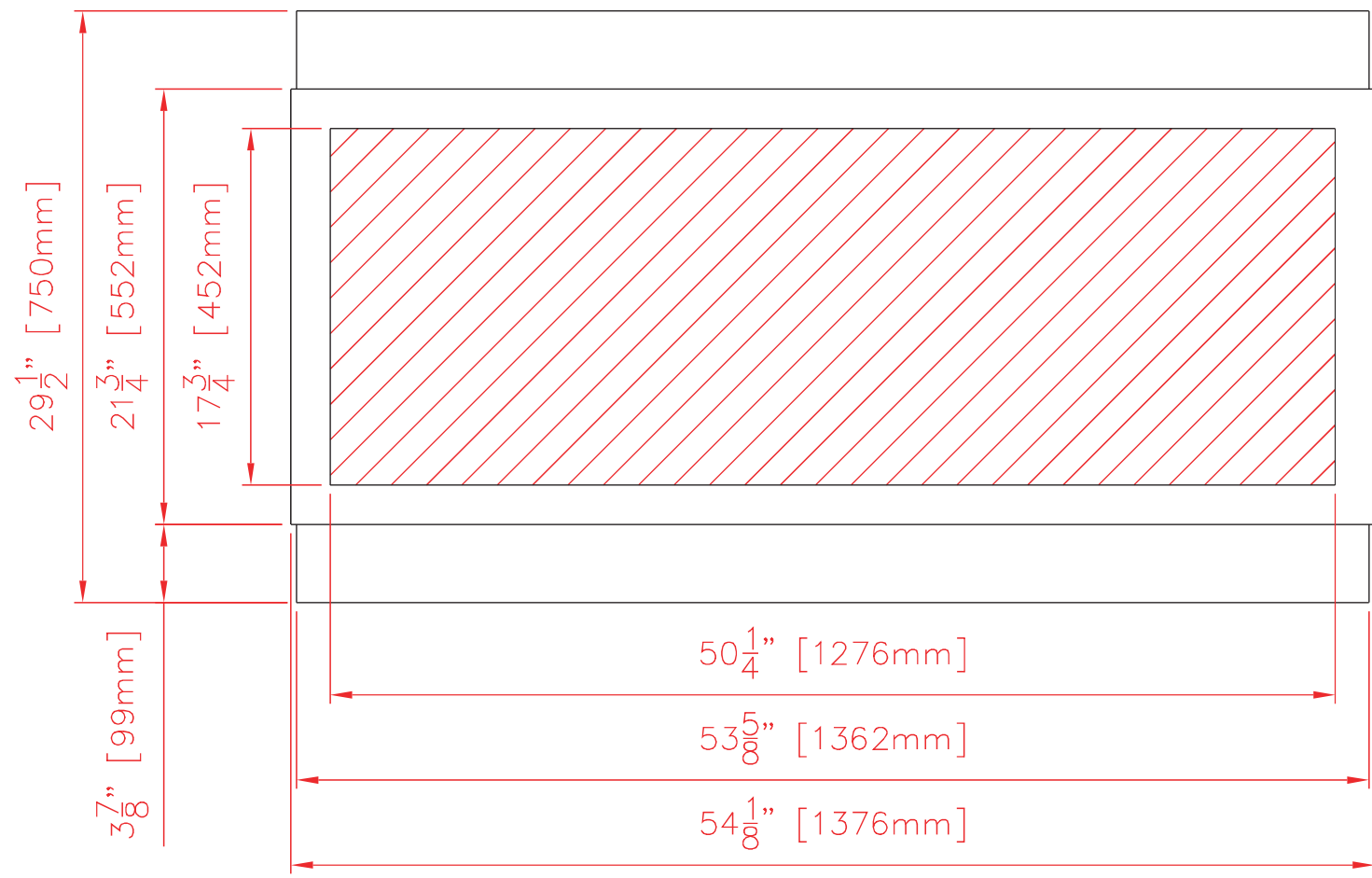

| TECHNICAL SPECIFICATIONS |                                    |
|--------------------------|------------------------------------|
| VOLTAGE                  | 120 AC<br>60 Hz                    |
| WATTS                    | 1500 W Max                         |
| NO HEATER                | 25 W                               |
| MOTOR HEATER             | 19 W                               |
| APPLIANCE WIDTH          | 53 5/8" or 136.2 cm                |
| APPLIANCE HEIGHT         | 29 1/2" or 75 cm                   |
| APPLIANCE DEPTH          | 12 5/8" or 32.2 cm                 |
| GROSS WEIGHT             | 110 lbs or 50 kg                   |
| PLUG LOCATION            | Left side                          |
| CORD LENGTH              | 70 7/8" or 180 cm                  |
| ROUGH WALL OPENING       | 55" x 30" or<br>139.5 cm x 76.2 cm |
| BTU                      | 4800                               |



|                    |                            |   |              |
|--------------------|----------------------------|---|--------------|
| SERIES<br>Built-In | MODEL<br>55-XT - 102745-XT |  | REV<br>1     |
| SCALE 1" = 1'-0"   | DATE: 11/16/2017           |   | SHEET 1 OF 1 |

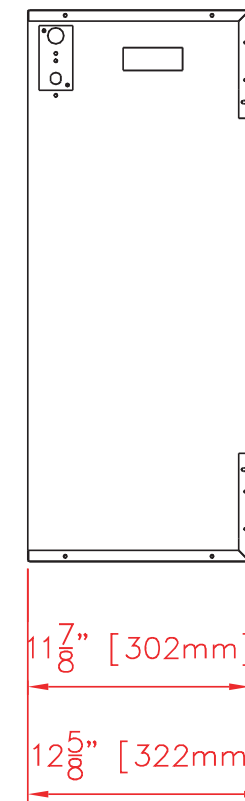
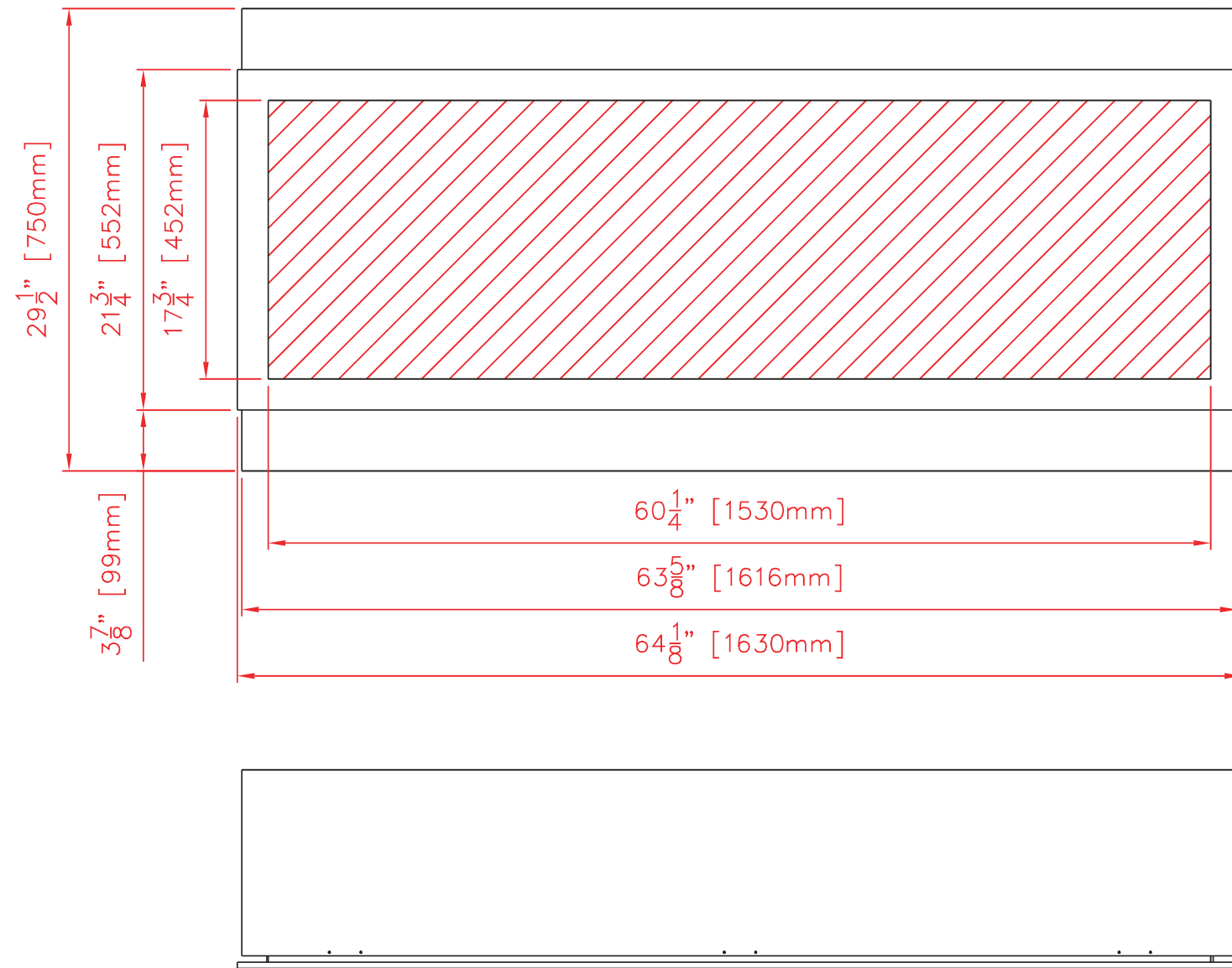

### TECHNICAL SPECIFICATIONS

|                    |                                  |
|--------------------|----------------------------------|
| VOLTAGE            | 120 AC<br>60 Hz                  |
| WATTS              | 1500 W Max                       |
| NO HEATER          | 25 W                             |
| MOTOR HEATER       | 19 W                             |
| APPLIANCE WIDTH    | 63 5/8" or 148.5 cm              |
| APPLIANCE HEIGHT   | 29 1/2" or 75 cm                 |
| APPLIANCE DEPTH    | 12 5/8" or 32.2 cm               |
| GROSS WEIGHT       | 127.6lbs or 58kg                 |
| PLUG LOCATION      | Left side                        |
| CORD LENGTH        | 70 7/8" or 180 cm                |
| ROUGH WALL OPENING | 65"× 30" or<br>165.1 cm× 76.2 cm |
| BTU                | 4800                             |



|                    |                            |   |              |
|--------------------|----------------------------|---|--------------|
| SERIES<br>Built-In | MODEL<br>65-XT - 102745-XT |  | REV<br>1     |
| SCALE 1" = 1'-0"   | DATE: 11/16/2017           |   | SHEET 1 OF 1 |