

Suggested Installation for Mantel Shelves using the included Hanger Board system

The hanger board is only a suggested method; your installer may have additional methods for mounting your mantel shelf. Always consult a professional.

THANK YOU FOR PURCHASING A PEARL MANTELS SHELF!

Look for the Pearl Inlay on the right-hand corner of your new mantel shelf.
This is your guarantee of an authentic Pearl Mantels™ product!

Included in your carton: Mantel Shelf, Detached Mitered Hanger Board (Hardware to install detached hanger board not included), Instruction Sheet, Certificate of Authenticity and (If Applicable): Corbels with hardware for attaching to the bottom of the shelf and (If Applicable): Arch with hardware for attaching between the corbels and to the bottom of the shelf. (If Applicable): Included hardware pack will be wrapped in red tape.

Not included: Mounting hardware for detached hanger board. There are many different mounting surfaces, i.e. brick, stone, drywall... and each requires a different hardware for secure attachment. **Always consult a professional.**

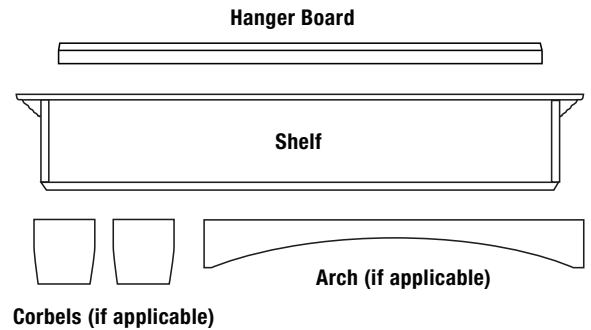

Wood and MDF (Medium Density Fiberboard) are combustible materials. Heat clearances must be adhered to. Before installing, adhere to your local building codes and manufacturer's requirements for your specific firebox or stove.

Assembly: If your shelf does not include corbels or an arch, no assembly is required. If your shelf does include corbels or corbels and arch, please refer to the additional instruction sheet included in your carton for assembly instructions.

Do not proceed without full understanding of the firebox's wood clearance requirements and local building codes. Wood and MDF are combustible and required clearances must be adhered to or damage will occur to your mantel.

Measuring/Mounting

Always check Building Codes and Heat Clearances; Wood and MDF are Combustible. Always attach hanger board to studs. Always consult a professional.

The Hanger Board system consists of 2 mitered hanger boards, one is attached to the back of the mantel shelf and the other is packed separately in the carton and will attach to your mounting surface. When married together, the mantel shelf will be locked in place on the wall.

* Mounting hardware for detached hanger board is **NOT INCLUDED**.

We suggest that pilot holes be drilled into the hanger board prior to inserting the appropriate hardware for final installation on the wall. **Always attach to studs.**

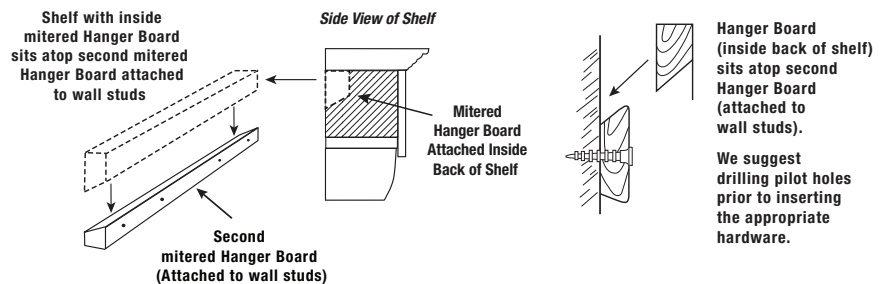

Measuring: Measure from bottom of the shelf to the bottom of the hanger board (1) (See Figure A. below). This measurement is where the bottom of the shelf will be when mounted on the hanger board and this distance must be in compliance with heat clearance requirements of the firebox and building codes.

Figure A.

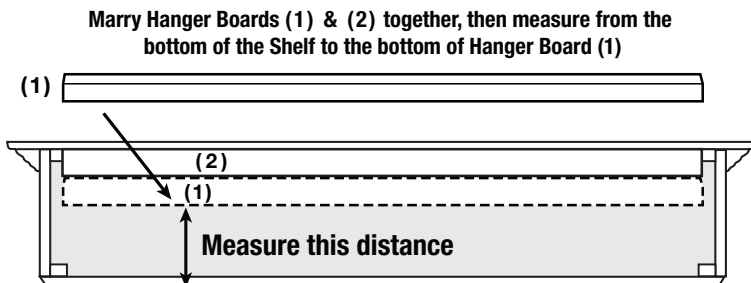

Measure from the floor or the hearth to where the bottom edge of the hanger board will be, remembering to add the distance to the bottom of the shelf (see Fig. A), and mark your recorded measurements on the wall both right and left. Center your hanger board (see Figure B), ensure your pilot holes align to studs and mount the hanger board so that the bottom of the board is on your recorded marks. Hang your shelf. Some surfaces may not be flush which may require shims or filling of gaps. **Always consult a professional.**

Centering: Find center point over firebox by measuring from one side to the other, mark the center point on mounting surface, do the same for the hanger board. (See Figure B. below)

Figure B.

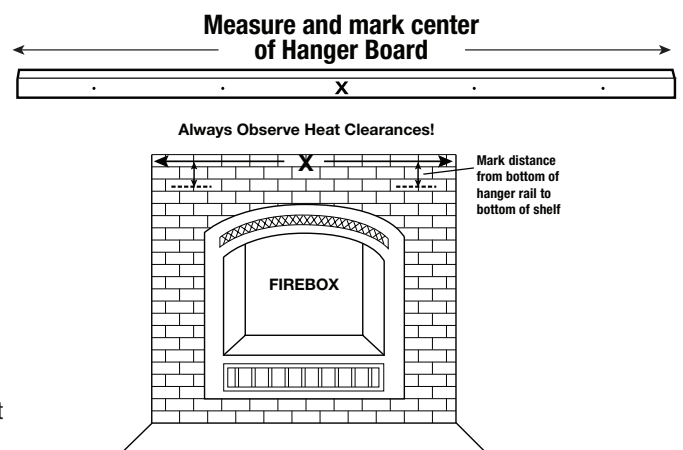

Unfinished Wood Mantel Shelf: Always consult a professional before applying paint or stain.

Pearl Inlay: If you have purchased an unfinished piece, your Pearl Inlay is masked with red tape so that you may paint or stain over it. After you have completed the paint/stain process, remove the mask.

Always consult a professional.

Thank you for your purchase!

You have the option of installing your shelf alone (Option 1), shelf with corbels (Option 2), or shelf with corbels and arch (Option 3):



Option 1

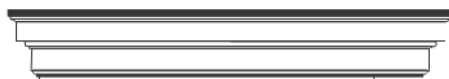

Option 2



Option 3

If you decide not to use the corbels, please proceed to [Installation using the Hanger Board](#)

How to attach the corbels

Your shelf has 2 wooden nut plugs placed at each end of the bottom of the shelf for the corbels.

1. Turn the shelf upside down on a soft surface
2. Tap out the wood nut plugs using a flat head screw driver and hammer (Figure A.) You will be left 2 holes on each end of the shelf. If you will be attaching the center arch (see below), the side nut plugs on each corbel must also be tapped out and face the arch in the center of the shelf.
3. Put the washers onto the bolts.
4. With the shelf still upside down line up the pre threaded inserts of the corbels with the holes in the bottom of the shelf. (Figure B.)
5. Before installing, insert the bolts through the holes in the bottom of the shelf and tighten into the threaded inserts.

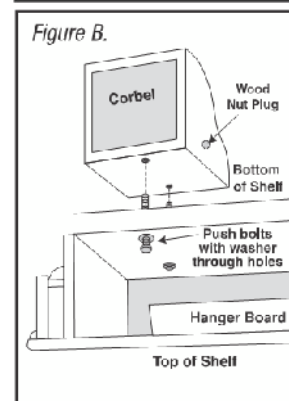
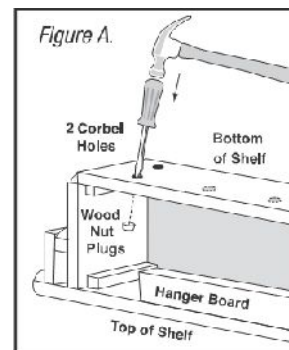

How to Attach the arch

Your shelf has 3 wooden nut plugs placed in the back of the bottom shelf and one on the side of each corbel for the arch.

1. Turn the shelf upside down on a soft surface.
2. Tap out the wood nut plugs using a flat head screw driver and hammer (Figure C.) You will be left with 3 holes along the back of the shelf, and one on the side of each corbel. Make sure the hole side of each corbel faces the arch in the center of the shelf.
3. Put the washers onto the bolts.
4. With the shelf still upside down line up the pre threaded inserts of the arch with the holes in the bottom of the shelf and sides of corbels. (Figure D.)
5. Before installing, insert the bolts through the holes in the bottom of the shelf and corbels, and tighten into the threaded inserts.

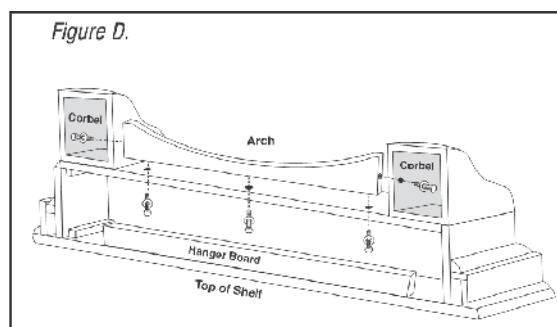
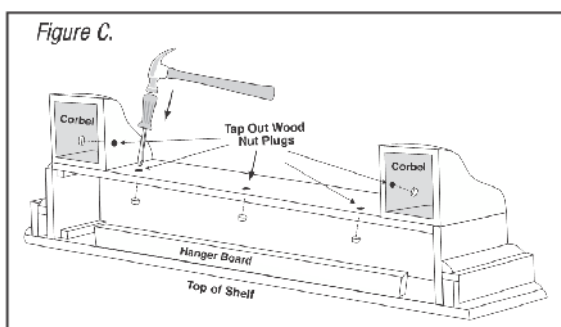

Installation using the Hanger Board

For hanging your shelf, we suggest that you use the hanger board included in this box.

The type of hardware (not included) you will use for mounting your hanger board will depend upon the medium your shelf will be attached to (i.e. brick, stone, drywall...). Please consult a professional for advice on the proper hardware.

Measuring

The hanger board measurement should be taken from the floor or the hearth to the bottom edge of the hanger board. Mark your recorded measurement on your wall, both left and right. Take the wall hanger board and mount it on the wall so that the bottom edge of the board is on your recorded marks. Check to see that your wall hanger board is centered over your firebox before mounting

Once mounted, if the shelf doesn't seem to fit snugly to the wall, you may put a small shim of paper, cardboard, etc. to fill the gap where the 2 halves of the hanger board meet.

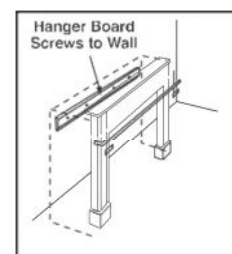
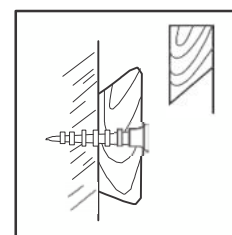

Suggested Preparation Prior to Painting or Staining of Wood Mantels

Please consult a professional.

The hanger board is only a suggested method. Your installer may also have additional methods for mounting your mantel or shelf.

We suggest that pilot holes be drilled prior to inserting the appropriate hardware for final installation on the wall surface.

Wood and MDF mantels are considered combustible materials. Heat clearances must be adhered to. Before installing, check your local building codes and the manufacturer's instructions for your specific fireplace insert or stove.