



THE OUTDOOR
GREATROOM
COMPANY

Denali Fire Table

Installation Instructions for Denali Fire Pit Table
DENBR-1242





IMPORTANT



Please consult your Crystal Fire instruction manual for detailed instructions and important information related to the burner installation including: lighting and operating instructions, safety information, and proper tightening of connections with two wrenches.

DO NOT ATTEMPT TO INSTALL CRYSTAL FIRE BURNER WITHOUT CONSULTING THE CRYSTAL FIRE OWNER'S MANUAL.

CONTENTS

1. About Your Fire Table	2
a. Required Tools	
b. Included With Your Fire Pit	
2. Assembly Instructions	3
a. Unpacking	
b. CF-SPARKER and Control Valve Assembly	
3. Setting Up Your Burner	4
a. Gas Connections	
b. Burner Installation	
c. Electrode Installation	
d. Propane Tank Installation	
4. Miscellaneous	7
a. Fire Media Installation	
b. Glass Cover Installation	
c. Burner Cover Storage	
d. Bottle Opener Attachment	
5. Operating Instructions	9
6. Warnings	10

1. ABOUT YOUR FIRE TABLE

A. REQUIRED TOOLS

- Utility Knife -
To cut and remove packaging
- 2 Open Ended Wrenches-
To secure gas connections
- Phillips Screw Driver *(Do not use a drill to assemble)-*
For assembly and attachment of bottle opener
- One AAA Battery *(Not Included)-*
Required for electric spark igniter installation

B. INCLUDED WITH YOUR FIRE PIT

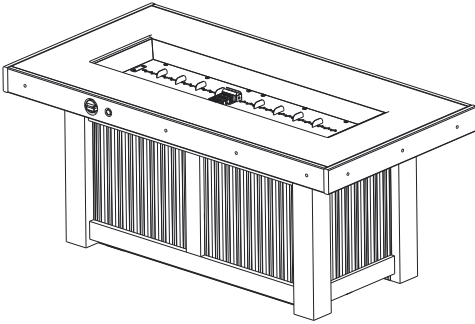

Fully Assembled Denali Fire
Table with CFPI242 Burner
(1)



Burner Cover
(1)

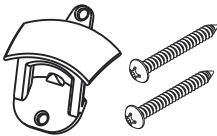

Bottle Opener Kit
(1)

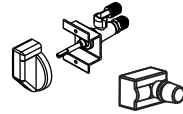

Control Valve, Knob and
CF-SPARKER
(1)



CF-1242 Burner and Accessories
(1)

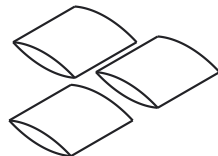

Bags of Glass Beads(3)



2. ASSEMBLY INSTRUCTIONS



WARNING



Exposed edges may be sharp, use leather gloves when removing packaging and handling the base.

A. UNPACKING

- Do not discard any packaging until assembly is complete and unit is tested.
- Keep all included manuals in a safe place for future reference.
- Two people are recommended to remove table from packaging.
- Place table in desired location before installing control valve and gas connection.

B. CF-SPARKER AND CONTROL VALVE

- Control valve and sparker comes fully assembled in table. Image 2.1
- Remove CF-SPARKER cap and hex nut. Insert AAA battery (*not included*) with + end out. Image 2.2

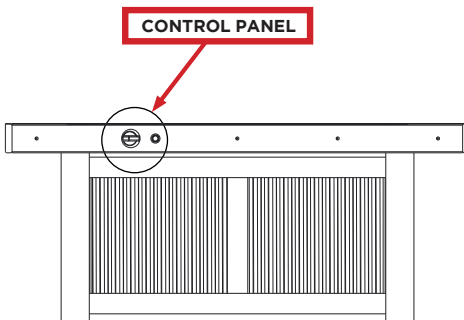

Image 2.1

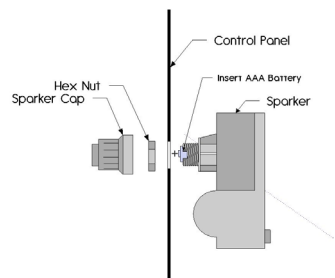

Image 2.2

3. SETTING UP YOUR BURNER

⚠ ATTENTION ⚠

Read and understand your Crystal Fire owner's manual before beginning burner hookups or using the device.

DO NOT USE TEFLON TAPE OR PIPE DOPE ON FLARE FITTINGS.

A. GAS CONNECTIONS

⚠ WARNING ⚠

Ensure valve is in the **OFF** position before making any gas connections.

• Turn valve to OFF position. Image 3.1

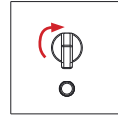

Image 3.1

• **USE TWO WRENCHES TO ENSURE A GAS TIGHT CONNECTION.** Image 3.2

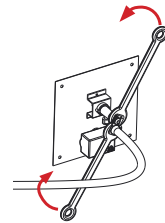

Image 3.2

• For propane tank installations, install included propane hose and regulator to the control panel. Image 3.3

• For hard piped installations. Connect the gas supply line (*not included*) to the 3/8" male flare fitting on the valve. **USE TWO WRENCHES TO ENSURE A GAS TIGHT CONNECTION.**

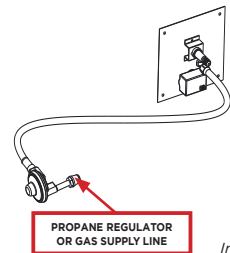

Image 3.3

• Run gas pipe up through the opening in the bottom on the base. Image 3.4

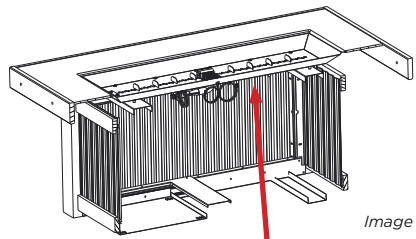

Image 3.4

IMPORTANT

Please consult your Crystal Fire instruction manual for detailed instructions and important information related to the burner installation including: lighting and operating instructions, safety information, and proper tightening of connections with two wrenches.

DO NOT ATTEMPT TO INSTALL CRYSTAL FIRE BURNER WITHOUT FIRST CONSULTING THE CRYSTAL FIRE OWNER'S MANUAL.

B. BURNER INSTALLATION

ATTENTION

**TIGHTEN ALL CONNECTIONS
SECURELY WITH TWO WRENCHES**

- Ensure the correct orifice is installed for the fuel type you are using (see Crystal Fire burner owner's manual included with burner for orifice sizing information).
- Connect flex line to the control valve
USE TWO WRENCHES TO SECURE CONNECTION.
- Installation and repair should be performed only by a qualified service technician.

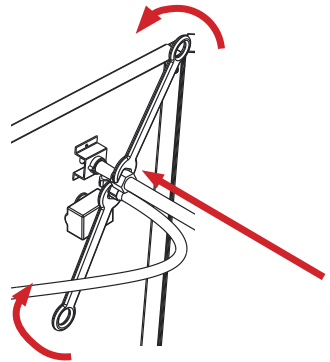

C. ELECTRODE INSTALLATION

- Plug both BLACK wires hanging from the burner into the back of the CF-SPARKER. If an orange wire is present, DO NOT USE IT. The orange wire is for Direct Spark Ignition system only.

Image 3.8

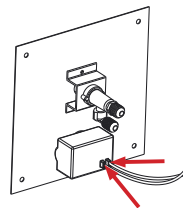

Image 3.8

- Test system by pushing the button on the igniter. Consult the troubleshooting section of the Crystal Fire owner's manual if the spark is weak, intermittent or not present. Image 3.9

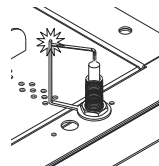

Image 3.8

D. PROPANE TANK INSTALLATION



HAND TIGHTEN, DO NOT USE A WRENCH FOR THIS CONNECTION.



Over time the bearings in the door glides may require re-greasing. Any spray lubricant, such as WD-40, may be used to lubricate drawer glides. Perform annually or on an as needed basis to maintain smooth operation.

- Lift door up and slide back into table. Door will slide along metal glides. Image 3.10
- Pull out tank tray. Image 3.10
- With the propane tank valve and fire pit valve off, attach the propane regulator to the propane tank. Image 3.11
- Place tank in tank tray.

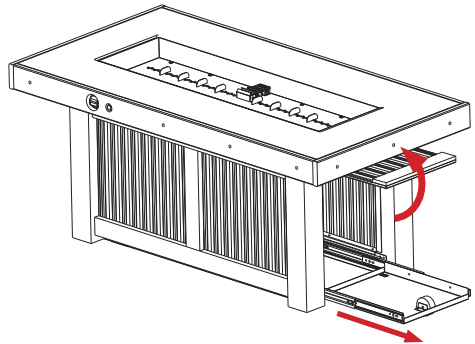

Image 3.10

- Slide tank drawer in. Ensure no hoses or wires are contacting the bottom of the burner. Image 3.11
- To replace access door, pull door outward and bring back down into resting position.

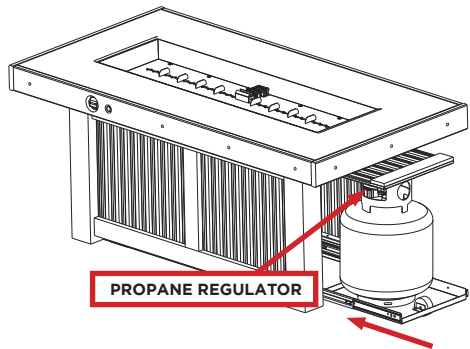

Image 3.11



4. MISCELLANEOUS

A. FIRE MEDIA INSTALLATION



WARNING



DO NOT OPERATE CRYSTAL FIRE BURNER WITHOUT INCLUDED GLASS BEADS OR OTHER APPROVED FIRE MEDIA.

- Scatter all included glass beads, lava rock, or other approved fire media evenly across entire burner surface. Image 4.1

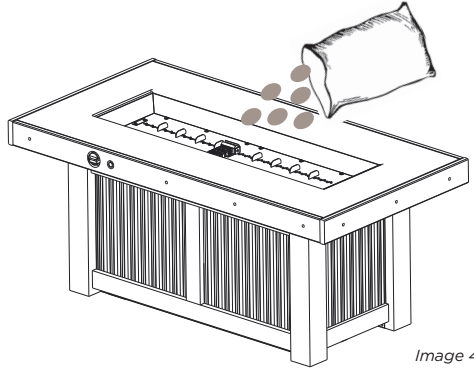

Image 4.1

B. BURNER COVER INSTALLATION



WARNING



DO NOT OPERATE CRYSTAL FIRE BURNER WITH BURNER COVER IN PLACE.

- Fully shut off gas supply to table and turn control valve knob to OFF position. Wait for burner to become cool before placing cover. Image 4.2

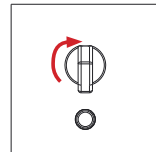

Image 4.2

- Carefully place the cover on top of the burner. Image 4.3
- Remove burner cover before attempting ignition.

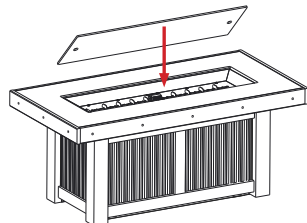

Image 4.3

C. BURNER COVER STORAGE



Use caution when removing and placing the burner cover as to not chip or damage the edge.

When not in use, Burner cover can be conveniently stored on side of table

- Locate cover holders on lower base. Image 4.4. Flip cover holders down. Place burner cover onto holders.
- Rotate securement downward, over cover, to lock cover in place.
- To remove cover, rotate securement pins upward, lift cover off holders and place back into burner opening. Flip cover holders back up.

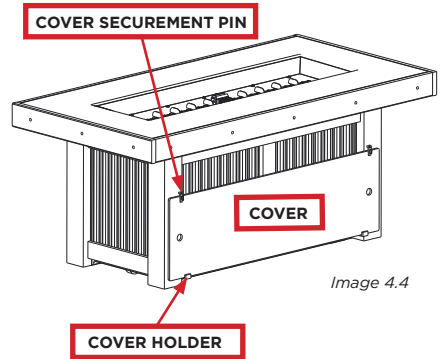

Image 4.4

D. BOTTLE OPENER ATTACHMENT

Bottle opener can be placed on side of table top trim in a location of your choosing. For best results, and to eliminate any splitting of wood, bottle opener should be centered on trim and at least 3 inches from edge. Image 4.5 gives an example of bottle opener placement. Pre-drill holes for screws before attaching bottle opener.

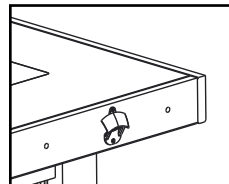
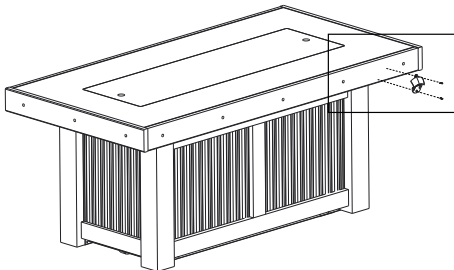

Image 4.5



5. OPERATING INSTRUCTIONS

⚠ IMPORTANT ⚠

Before operating your DENBR-1242, ensure all gas connections are properly tightened and thoroughly leak checked. Refer to the Crystal Fire manual for information on proper leak checking and other critical safety information.

With the valve on the fire pit in the OFF position, open the valve on the propane tank or natural gas supply.

With burner cover removed, double check to make sure there are no gas leaks at the regulator or inlet side of the valve. If leak is detected, immediately shut off the gas supply and wait 5 minutes to allow gas to dissipate. Fix any leaks before proceeding.

Press the sparker button and hold, look and listen for spark between electrode and grounding rod.

While depressing the sparker, open the valve.

⚠ ATTENTION ⚠

Refer to the Crystal Fire manual included with your burner for more detailed information on operation, maintenance, and safety of your burner.

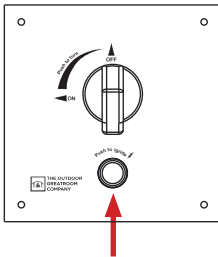

1. Press in sparker

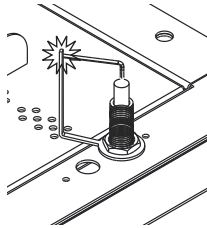

2. Look/listen for spark

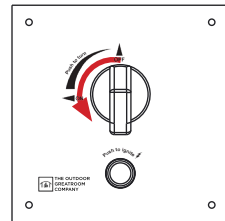

3. Turn valve to ON

If burner does not light after 10 seconds, close the valve and wait 5 minutes to allow gas to dissipate before attempting ignition again.

6. WARNINGS

IMPORTANT

Please consult your Crystal Fire instruction manual for detailed instructions and important information related to the burner installation including: lighting and operating instructions, safety information, and proper tightening of connections with two wrenches.

DO NOT ATTEMPT TO INSTALL CRYSTAL FIRE BURNER WITHOUT FIRST CONSULTING THE CRYSTAL FIRE OWNER'S MANUAL.

WARNING

After consulting the manual and following instructions, remember: before operating, all gas connections must be fully checked for leaks.



WARNING: This product can expose you to chemicals including Carbon Monoxide and Benzene which are known to the State of California to cause cancer or birth defects or reproductive harm. For more information, visit www.P65Warnings.ca.gov

Thank you for purchasing an
Outdoor GreatRoom Company
product! This fire pit was made
with pride in the USA.



Warranty: Fire pit tables are covered under a 1 year
manufacturer's warranty.

Please visit <http://www.outdoorrooms.com/product-registration>
to register your product.



14400 Southcross Drive West • Suite 100 • Burnsville, MN 55306
Toll Free: 1-866-303-4028 • Sales@OutdoorRooms.com