

MANUAL LIT SYSTEM

Natural Gas (NG)

60,000 BTU



fire pit installation and user manual

CONTENTS

Standards	<i>Page 2</i>
Product Ratings	<i>Page 2</i>
Product Warnings	<i>Page 3</i>
Location of the Fire Pit	<i>Page 6</i>
Fire Pit Clearances	<i>Page 7</i>
Unpacking	<i>Page 7</i>
General Lifting Guide	<i>Page 8</i>
Installation and Operation	<i>Page 10</i>
Media Installation	<i>Page 14</i>
General Care and Maintenance	<i>Page 16</i>
End of the Season Checklist	<i>Page 17</i>
Start of the Season Checklist	<i>Page 18</i>
Troubleshooting	<i>Page 19</i>
Warranty Information	<i>Page 20</i>
Parts List	<i>Page 22</i>
Optional Accessories	<i>Page 22</i>
Product Registration	<i>Page 25</i>



inspired, designed, certified and proudly built in Canada
1.877.255.3146:info@solusdecor.com
<https://www.solusdecor.com/>



January 2022

This user manual contains information that is critical to the installation and operations of your Solus Fire Pits. For safety, please follow these instructions carefully.

This fire pit conform to the following standards:

ANSI Z21.97 – 2004 / CSA 2.41 -2017 *Outdoor Decorative Gas Appliance*

CSA 2.17-2017 *Gas-Fired Appliances For Use at High Altitudes*

CE BS EN 498:2012 *Specification for Dedicated Liquefied Petroleum Gas Appliances*

CE BS EN 509:2001 + A1 : 2003 + A2: 2004 *Decorative Fuel-Effect Gas Appliances*

Made in Canada by Solus Decor Inc.
Building C-109 Braid Street, New Westminster, BC Canada V3L5H4
1.877.255.3146 www.solusdecor.com

PRODUCT RATINGS

GAS RATINGS

Natural Gas (NG)

Inlet Gas Pressure : 7 "W.C. (17.4mbar) (0.25 PSI)



Manifold Gas Pressure :

<u>Burner Ratings</u>	<u>Minimum Manifold Pressure Requirement</u>
60,000 BTU (17.58kW)	3.5"W.C. (8.7mbar) (0.12 PSI)
73,500 BTU (21.39kW)	3.5"W.C. (8.7mbar) (0.12 PSI)
108,000 BTU (31.65kW)	2.5"W.C. (6.2 mbar) (0.09 PSI)

WARNING: Consistent *Inlet Gas Pressure* is required to avoid weak pilot flame and burner dropouts.



PRODUCT WARNINGS

 DANGER	CARBON MONOXIDE HAZARD This appliance can produce carbon monoxide which has no odor. Using it in an enclosed space can kill you. Never use this appliance in an enclosed space such as a camper, tent, car or home.
	



DANGER: If you smell gas:

- 1) Shut off gas to the appliance.
- 2) Extinguish any open flame.
- 3) If the odor continues, keep away from appliances and immediately call the gas supplier or fire department.



WARNING: For Outdoor Use Only



WARNING: Only Licensed Gas Fitters and Electricians are allowed to install and perform repair services on this fire pit



WARNING: This Fire pit should be inspected before use and at least once annually by a qualified technician.



WARNING: This manual contains information critical to the safe installation and operation of the fire pit















WARNING Never alter product or configuration in any way



WARNING: Fuel line sizing and or/regulations are the responsibility of the installer and must be able to supply the stated Product Ratings.



WARNING: Testing for leaks after installation is the responsibility of the installer.

-  **WARNING:** All fire pits must have a gas shutoff outside of the exterior of the fire pit to allow for emergency shut off and maintenance.
-  **WARNING:** All fire pits with an electric start system, must have an electrical shut off (wall switch or breaker) on the exterior of the fire pit or on an adjacent wall to allow for emergency shutdown and maintenance.
-  **WARNING:** Improper installation, adjustment, alteration, service, or maintenance can cause injury or property damage. Read the installation, operating, and maintenance instructions thoroughly before installing or servicing this equipment
-  **WARNING:** Improper installation, adjustment, alteration, service, or maintenance can cause injury or property damage. Read the installation, operating, and maintenance instructions thoroughly before installing or servicing this equipment
-  **WARNING:** Improper installation, adjustment, alteration, service, or maintenance can cause injury or property damage. Read the installation, operating, and maintenance instructions thoroughly before installing or servicing this equipment.
-  **WARNING:** Do not use this fire pit if any part of it has been under water. Call a licensed technician to inspect the fire pit and replace the parts under water as necessary
-  **WARNING:** Do not store or use gasoline or other flammable near the fire pit.
-  **WARNING:** It is the installer's responsibility to ensure a safe installation and to educate the end user about proper operation. Leave this manual with the end user
-  **WARNING:** FOR REMOTE CONTROL USE: To prevent accidental start-up from unwanted RF signals it is the responsibility of the end user to turn off power to the electric outlet for the remote control receiver when the fire-pit is not in use via wall switch or breaker.
-  **WARNING:** This fire pit is not intended to be a starter for wood or any other combustibles.
-  **WARNING:** Select a location where the fire pit can be attended during operation. Never leave an operating fire pit unattended or by someone not familiar with its operation or emergency shut off locations.
-  **WARNING:** Both children and adults should be alerted to the hazards of high surface temperatures and should stay away to avoid burns and clothing ignition.
-  **WARNING:** Young children should be carefully supervised when they are in the area of the fire pit.



WARNING: Clothing or other flammable materials should not be placed on or near a fire pit.



WARNING: This fire pit emits very high temperatures - Combustibles must be located far enough away that there is no risk of ignition.



WARNING: All Solus vessels for Natural and Liquid Propane Gas are vented at the bottom. The ventilation allows for heat and/or residual fuel to escape. The vents also function as a drain to prevent water build-up. These vents must not be blocked or tampered with at any time. Failure to follow this instruction may result in the fire-pit overheating or explosion. Overheating could also lead to heat damage to internal components.



WARNING: The interior void space of the Solus vessel surrounding the gas valve and electrical box cannot be filled with any material (gravel, crushed rock, concrete, etc.) to allow for proper ventilation.



WARNING: Solus concrete vessels are HEAVY. Use care and caution during lifting, positioning and repositioning to prevent injury, damage to fire pits and damage to property. Some Fire Pits will require 2 or more people to lift; some may require 4 or more people. The Fire Pit must be evenly supported and level – Shim appropriately as required.



WARNING: The fire pit must be serviced annually by a professional certified in your jurisdiction.



WARNING: Installer must confirm the appliance is built for the appropriate gas used – natural gas or LP. Do not use natural gas appliances with LP or LP appliances with natural gas. Refer to the label on the appliance.



WARNING: To prevent damage, unhook the fire pit from the gas supply for pressure leak tests.



WARNING: Gas Plumbing Connections: Use only joint compound or tape that is resistant to all gases. Apply joint compound to all male pipe fittings only- DO NOT use on FLARED fittings. Be sure to tighten every joint securely.



WARNING: An LP-cylinder not connected for use shall not be stored in the vicinity of this or any other appliance

LOCATION OF THE FIRE PIT

All Solus Decor fire pits are intended and designed for **Outdoor Use Only**.

Stable Surface

The Solus fire pit vessel must be placed on a stable and flat surface. Select a location with good drainage that allows easy access for installation and maintenance of the fire pit.

Consider the location with less unfavorable winds

Solus Burner is designed to withstand 10MPH (16.0934KPH) wind speed. Consider purchasing a Solus WindShield if the location is prone to severe and unpredictable wind activities like open beachfront spaces or high rise building patios and balconies.

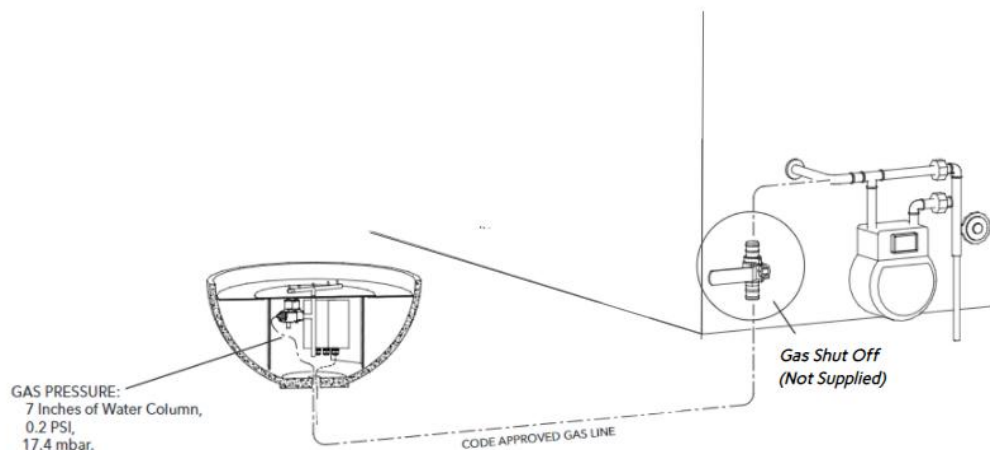

Gas Shut Off

All Fire pits must have a gas shut-off mechanism located outside of the appliance. This gas shut-off mechanism must be accessible for emergency shut-off and maintenance. Please note that the Key Valve outside the vessel of this firepit is not a shut-off mechanism. This Key Valve is used to regulate the flame height and flame intensity.

FIRE PIT CLEARANCES

Horizontal Clearance

Concrete vessels must be at least 16 inches (0.5 meter) away from any combustible structure and/or materials.

Vertical Clearance

Clearance between the burner and any structure overhead must be at least 77 inches (1.95 meter) from any combustible structure and/or materials.

UNPACKING

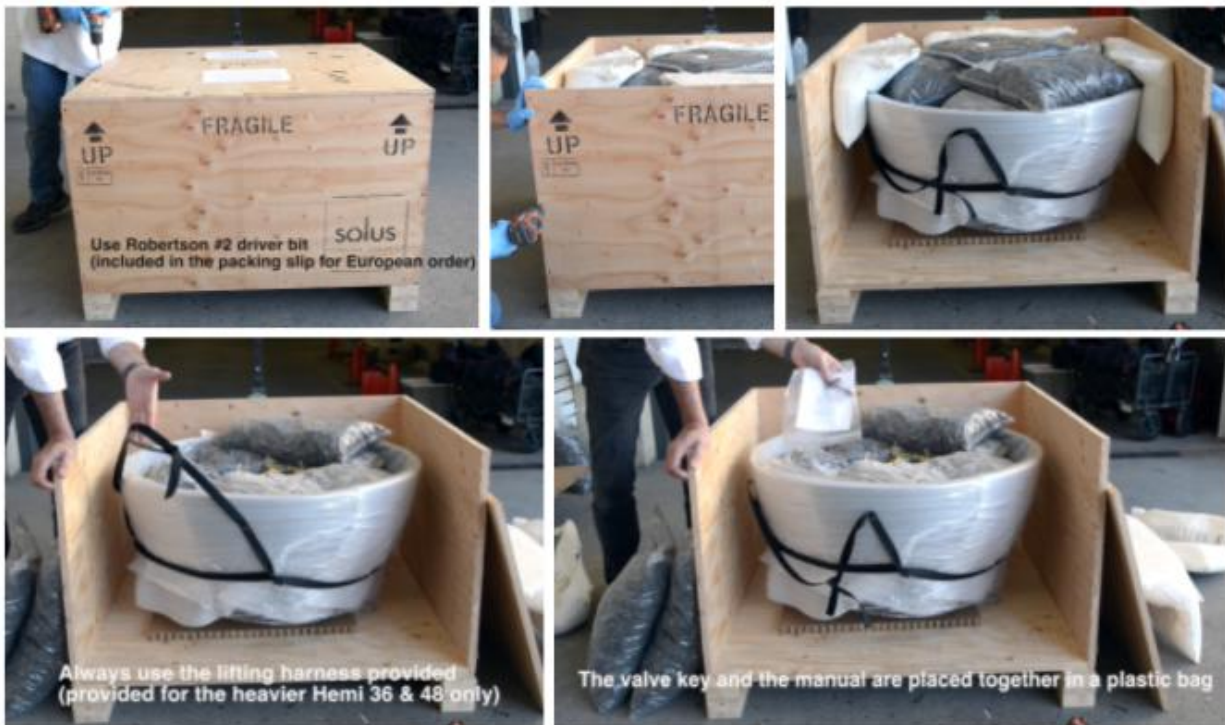

The fire pit will arrive in an exquisite crate, fully foamed padded. Carefully inspect the crate for damages during delivery. Open the crate immediately if any damages are observed. Document the damages through photographs and report to Solus Decor at once.

Crate Check

Customers are required to report any crate damages within 24 hours of receiving the crates.

Contents Check

Furthermore, it is the customer's responsibility to check it's contents within 48 hours from receipt of the shipment to check for content damages.

Solus is not responsible for damages reported beyond these timelines.

GENERAL LIFTING GUIDE

WARNING:

These concrete products are heavy and bulky. Moving these concrete products may require multiple people. Refer to the table on the next page.



Please note that only Hemi 36 and 48 bowls are provided with straps that act like a carrying harness.

Product Type	Lbs	Kgs	Number of Person Needed to Lift
Hemi 26	81	37	2
Hemi 36	156	71	2 (straps attached)
Hemi 48	317	144	4 (straps attached)
Halo 36 Low Base	76	35	2
Halo 36 Low Top	244	111	2-3
EHA 36 Box	230	105	2-3
EHA 36 Top	244	111	2-3
Halo Low 48 Base	75	34	2
Halo Low 48 Top	526	239	5
EHA 48 Box	230	105	2
EHA 48 Top	526	239	4-5
Firetable Base	74	34	2
Firetable Box	243	110	2-3
Firetable Top	134	61	2
Firebox 30	243	110	2-3
Firecube with Lid	156	71	2
Tavolo Base	75	34	2
Tavolo Box	243	110	3-4
Tavolo Top	410	186	4
Linear	148 per slab	67 per slab	2



inspired, designed, certified and proudly built in Canada

1.877.255.3146:info@solusdecor.com

<https://www.solusdecor.com/>

North America Only

INSTALLATION and OPERATION

WARNING:

Installation and repair must be done by Licensed Gas Fitters. The fire pit must be inspected before use and at least checked or serviced annually by a qualified service technician. Cleaning may be required frequently as necessary. When a fire pit is not in use, an all-weather cover or metal top must be used to avoid water and moisture build-up and to protect the fire pit from environmental hazards.

- *Fire Pit Ratings* : Check the Output BTU Ratings of the fire pit and ensure the following requirements are followed

Gas Rating (NG) :

Inlet Gas Pressure : **7 "W.C. (17.4mbar) (0.25 PSi)**

Manifold Gas Pressure

<u>Burner Ratings</u>	<u>Minimum Manifold Pressure Requirement</u>
60,000 BTU (17.58kW)	3.5"W.C. (8.7mbar) (0.12 PSi)

- *Inlet Pressure* : This is the input gas pressure coming from the main gas line going to the fire pit. Reading must be taken only after all other gas appliances on the main supply are on and running at full capacity.
- *Manifold Pressure*: This is the pressure at the manifold when the burner is on.
- *Gas Requirement* : Consistent ***Inlet Gas Pressure*** is required to avoid burner dropouts. ***THIS IS AN ABSOLUTE PRIORITY.*** The reading must be recorded and written on the installer's card and must be given to the owner/end user. Owner's must keep this card for future use and servicing. The readings must also be included in the product registration form (*page 25 of this manual*).



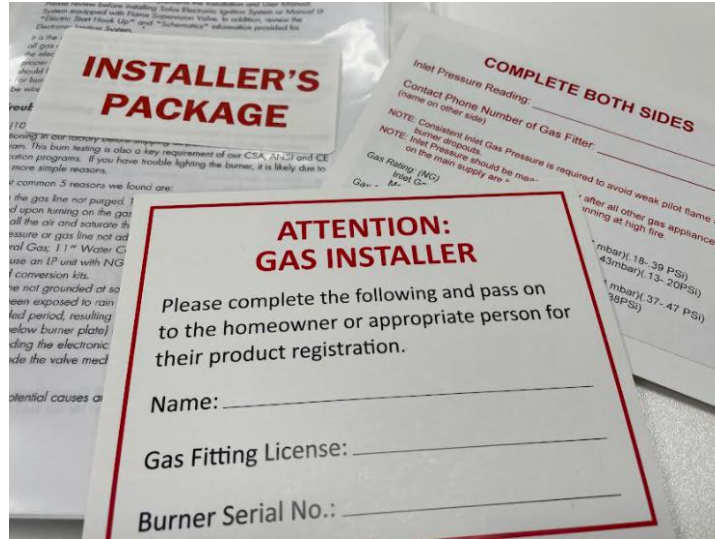

Locate all the components

- Installer's Package
- 3" Valve Keys
- 1/2" Yellow Flex Line
- Burner Assembly
- Concrete Bowl - Ball Valve
- RV47 Regulator

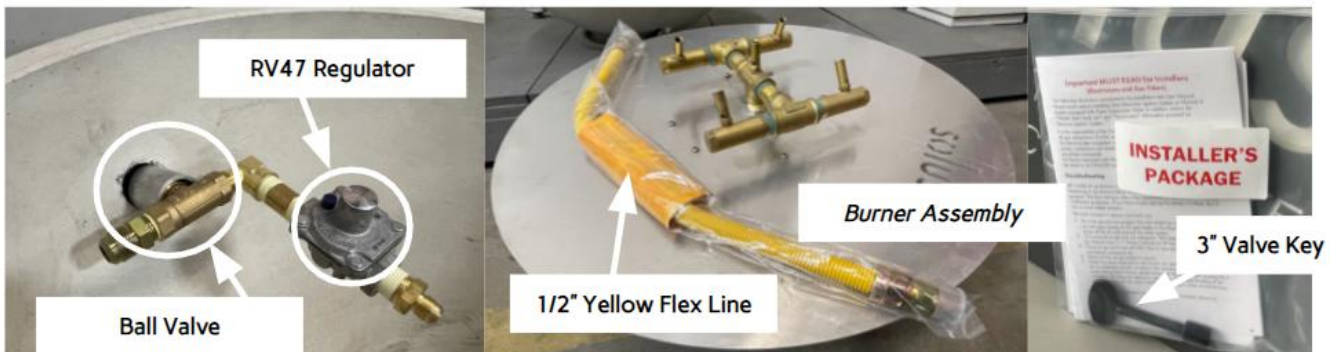

Gas Connection

- Make sure that the gas shut-off valve (emergency shut-off valve) of the appliance is closed when connecting the gas lines.
- Locate the Ball Valve inside the concrete bowl/vessel. This valve is supplied with flared fitting at both ends.
- Connect the one end of the yellow flex gas line (supplied) one end the Quarter Turn - Ball Valve and the other end to the burner manifold.
- Connect the end of the NG main supply line to the RV47 Regulator.
- Test all gas piping and connections for leaks after gas connections
- Do not use an open flame to check for leaks.



Yellow Flex Line (One End)
to Ball Valve



Yellow Flex Line (Other End)
to Burner Manifold



Gas Supply Line to the
RV47 Regulator
Note: Installer to supply gas line

Operation

Turning ON the MLS – NG System

- Read instructions very carefully.
- Remove any covers prior to operation.
- Confirm that the gas shut-off valve (emergency shut-off valve) is open.
- Locate the Ball Valve
- By using the 3" Valve Key (supplied), turn the tee- key valve freely counter-clockwise.
- Apply a flame with a barbecue lighter to the closest nozzle on the exterior of the burner.
- Once lit, use the 3" Valve Key to adjust the flame to desired height.



WARNING: Consistent *Inlet Gas Pressure* is required to avoid weak pilot flame and burner dropouts.

Turning OFF the MLS – NG System

- By using the 3" Valve Key (supplied), turn the valve freely clockwise.
- Make sure flame is totally out
- Close the gas shut-off valve (emergency shut-off valve).
- Allow the burner to cool down before installing the cover, if available.

Purging

Sometimes, due to in-activity or not-being used or if the fire pit just came out of the box or just completed a service, the system won't detect any gas flow in the beginning. This is due to the presence of unwanted gas/air and water in the system. Purging is the process of displacing gas/air inside the system with the required gas. To bleed air out of the line, turn the ball valve counterclockwise to open and observe any vapour coming out of the burner nozzles. Once vapour is observed, this means gas flow is already initiated. Apply a flame with a barbecue lighter to the closest nozzle on the exterior of the burner.

MEDIA INSTALLATION

WARNING:

Do not install any refractory stones (decorative river rocks) or lava rocks that are not supplied by Solus Decor. Landscape stones and other natural materials may explode when heated.



Lava Rock



Refractory Stones

WARNING:

Do not dump media over the burner and or the nozzles.

Lava Rock Bed

Cover the entire burner plate with lava rock. Add enough layers of lava rocks until it reaches the underside of the burner. *Do not cover the nozzles with lava rocks.* Make sure no dust or other particles are inside the nozzles prior to lighting.

Keep the jets/nozzles free and clear of any refractory stones and lava rocks.



Refractory Stone Placement

A small pool of decorative river rocks should be placed on and around the burner. Make sure that no rocks are blocking any of the burner nozzles. Rearrange these stones around to deflect flame into a natural appearance, this is referred to as Flame Sculpting.



GENERAL CARE AND MAINTENANCE

KEEP THE FIRE PIT COVERED WHEN NOT IN USE

Ensure that gas and power (when applicable) are shut off and the fire pit is cool before performing any service and maintenance.

We recommend that a qualified service technician performs the following maintenance procedure at the beginning of each fire pit season.

Cleaning the Burner Nozzles

Periodic check, inspection and cleaning of the burner assembly is recommended. This is to avoid unusual and unwanted flame behaviour as well as ignition failure. To clean the burner nozzles, remove the refractory stones and lava rocks to allow access to the burner. Use a scotch green pad or 320 grit sandpaper or a brush to scrape soot and remove any dust, spider web or any particles. To check for nozzle clogs, use a small paper clip or needle and carefully insert in the burner nozzles. Remove any clogs if any.

END OF THE SEASON CHECKLIST

When the fire pit is not going to be used for months (although it can be enjoyed year round), it is important to follow this end of the season checklist.

Shut off Main Gas Supply

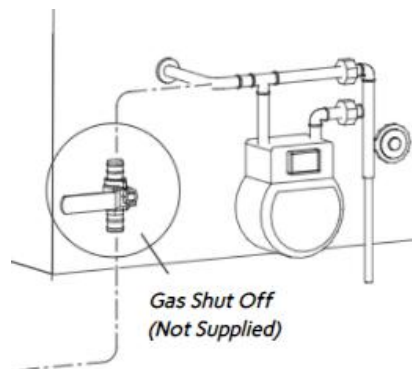

Accessories

Remove all accessories like wood tops, glass shield and store indoors



Unwanted debris

Check and remove any unwanted debris that can affect the look of your concrete fire pit.

Clean exterior of the fire pit

Moisture, dirt, dust and other surface contaminants must be wiped and cleaned. Use warm water and soap.

Cover your firepit

This is to protect your investment.



START OF THE SEASON CHECKLIST

The end of the season checklist is developed so fire pits can be used when the next opportunity happens. If the recommendations were followed, this fire pit should be as good as ready.

Remove Cover.

Solus provided all-weather covers are water resistant. Check the burner/nozzles and media for moisture. If they are wet, allow the components to dry. Please see the troubleshooting guide for instructions.

Inspect Gas and Supply Lines.

Inspect all gas connections prior to operation. Treat this as a new installation. Look for debris and kinks along the gas lines.

Inspect Burner.

A clogged and dirty burner nozzle can cause so many different issues. It restricts and blocks gas flow. Check and clean each nozzle when necessary. Water inside the nozzles can also cause the same issue. If water is suspected to have entered the burner and the piping system, contact a licensed gas fitter to drain water from the system.

Test Run.

If this fire pit wasn't used for more than one month, please treat this as a new installation and follow the "Turning on" instructions in this manual. Purging of air might be needed.

Clean the exteriors.

Clean the fire pit's exterior and get ready to enjoy another season of outdoor living. Use a hot soapy water, let it dry, then apply a stone sealer or enhancer (available in most DIY shops). Caution : Apply/Test on a small area before applying fully.

TROUBLESHOOTING

WARNING:

Turn off the fire pit and let it cool before servicing. Only qualified technicians should service and repair the fire pit.

Manual Lit System - Common Issues		
Issues	Possible Causes	Solutions
No Flame	Key Valve Closed	Open ball valve to allow gas flow
	Main Gas Supply Valve Closed	Open Main Gas Supply Valve
	Air in the line	Purge air from the line/check installation manual
	Water and moisture in the line	Vacuum the nozzles to remove moisture/or alternatively, use a hair dryer
Weak or Low Flame	Low Gas Pressure	Verify Gas Pressure
One or more nozzles not lighting or weaker than the other	Clogged or Dirty Burner Nozzles	Clean nozzles and check for obstruction
	Mismatched nozzles used	Check and compare nozzles, replace with correct nozzles if needed
Burner excessively noisy / Whistling	Too much gas pressure/presence of kinks and bends along the gas lines	Contact a technician. Verify Inlet Gas Pressure is within recommended ranges, check regulator settings if supplied, adjust accordingly. Check for kinks and bends
Unwanted Odours	Gas Leak	Shut off gas supply and call a technician



WARRANTY INFORMATION

Solus warrants that each Solus Fire Pits conforms to CSA, ANSI, CE and UKCA standards for *Outdoor Decorative Gas Appliance*. All concrete products are professionally inspected and passed Solus' above industry quality standard, and each and every gas burner burned and fire tested prior to leaving the Solus facility in Vancouver.

This warranty is voided if the fire pit is not installed by a licensed technician and/or if not maintained and operated according to the installation and user's manual. This warranty is also voided if product is modified, altered and tampered with and if a third-party parts and components were used during repair and maintenance.

Warranties are limited to the original purchaser only.

Upon Receipt of the Crate

Solus spares no expense on packaging these fire pits. They are crated and packed to museum quality standards. However, things can happen along the way. The purchaser, upon receipt of the crate, must visually inspect the crate for damages. Report any crate damages to Solus within 24 hours. Additionally, the content of the crate must be visually inspected within 48 hours. Report to Solus immediately. Solus is not responsible to any damages not reported beyond the specified timelines

Parts Only Limited Warranty

Solus will, at its election, repair or replace the part or product where Solus inspection discloses any such defect occurring with normal usage. Solus will replace all warranted parts free of charge. Client is responsible for the cost of shipping, duties and custom charges when applicable as well as the service and labour cost, re-installation and disposal of the replaced parts and components.

Solus does not provide onsite repair, visits or service.

This warranty does not cover damages to parts and products caused by inappropriate or improper installation, unauthorized modifications to the burner, vessel and parts, and improper maintenance such as failure to put the all-weather cover or metal top when fire pit is not in use.

Concrete Vessels Limited Warranty

Solus concrete products weather and tarnish through exposure to natural elements over time. This naturally occurring process is called Patina.



It is a very rare occasion that a vessel will fracture. Solus will replace cracked and broken concrete vessels resulting from structural defects. Client is responsible for any costs associated with crating, shipping, handling, re-installation labour or disposal of replaced products or components.

Non-structural hairline and spider web-like cracks, surface air voids, chips, scratches and abrasions or minor dimples will not affect the quality and performance of the fire pit therefore shall not be covered by this Warranty. Damages due to excessive loads, for example: Solus fire tables and bowls are not designed for seating purposes and are also not covered by this Warranty.

Any slight variation from the samples received, surface discoloration, texture changes and stains due to exposure to elements like salts, acids, birds droppings, insects, spilled drinks, greasy food and other harmful liquids also is not covered by this Warranty.

General Exclusions

This Warranty also excludes damages to the fire pit occurring due to accident, fire exposure, damages caused by wind and flooding, vandalism, ground movement, neglect, misuse and abuse.

Warranty Summary

Type	Components	No cover or metal tabletop purchased	Solus All-Weather cover and/or metal tabletop purchased
Manual Ignition Fire Features	Brass Burner and brass fittings Concrete Vessels	5 years 1 year	25 years 5 years



PARTS LIST

Parts Number	Parts Description
PO2085	3" Key
PO2185	Ball Valve
PO1985	Ball Valve & Flange
PO2180	1/2" Yellow Flex Line (36")
PO2182	1/2" Yellow Flex Line (26")
PO2002	Gas Regulator (NG) RV47L
PO1992	Burner Nozzles (NG 10K)
PO1987	Burner Manifold (NG) 60,000 BTU - 4 NZ crossfire
PO2072	Solus (NG) MLS Burner Package
A01818	NG to LP / MLS Conversion Kit

ACCESSORIES

All Weather Covers



Metal Table Tops



Hardwood Table Tops



inspired, designed, certified and proudly built in Canada
1.877.255.3146:info@solusdecor.com
<https://www.solusdecor.com/>
North America Only

Fire Stones



Glass WindShields



Tank Table



PRODUCT REGISTRATION

Thank you for purchasing a Solus Firepit! To protect your investment, please register your fire pit within 30 days of installation. Please supply all the required information at the time of installation. As noted in our Limited Product Warranty, professional registration number and gas pressure and input voltage readings are required to engage a warranty claim in the unlikely event that one is necessary.

CONTACT INFORMATION:

Name: _____ Organization/Company: _____

Address: _____

Telephone Number: _____ Email: _____

PRODUCT INFORMATION: (please retain proof-of-purchase)

Order #: _____ Firepit Model: _____ Fuel type: Natural Gas Propane Ethanol

Ignition type: Manual Light Manual Light w/Flame Supervision Valve Automatic (Electronic)

Date purchased: _____ Date of Install: _____

Product purchased: Solus directly Specifier / Contractor Reseller

BURNER SERIAL # _____

Gas Fitter Name: _____ Gas Fitter Registration #: _____

Gas Fitter Signature: _____ Date Signed: _____

Inlet Gas Pressure Reading : _____ Test Completed : Yes _____ / No: _____

How to submit the completed Product Registration Form?
North America - Return to:

Solus Decor Inc
Building C- 109 Braid St
New Westminster, BC V3L 5H4
Canada

Or scan and email to info@solusdecor.com
Or complete online at: www.solusdecor.com/warranty



inspired, designed, certified and proudly built in Canada
1.877.255.3146: info@solusdecor.com
<https://www.solusdecor.com/>
North America Only

AUTOMATIC IGNITION w/ Adjustable Flame

Natural Gas (NG)

60,000 BTU; 73,500 BTU; 108,000 BTU



fire pit installation and user manual

CONTENTS

Standards	<i>Page 2</i>
Product Ratings	<i>Page 2</i>
Product Warnings	<i>Page 3</i>
Location of the Fire Pit	<i>Page 6</i>
Fire Pit Clearances	<i>Page 7</i>
Unpacking	<i>Page 7</i>
General Lifting Guide	<i>Page 8</i>
Installation and Operation	<i>Page 10</i>
Media Installation	<i>Page 16</i>
General Care and Maintenance	<i>Page 18</i>
End of the Season Checklist	<i>Page 21</i>
Start of the Season Checklist	<i>Page 22</i>
Troubleshooting	<i>Page 23</i>
Warranty Information	<i>Page 25</i>
Parts List	<i>Page 27</i>
Optional Accessories	<i>Page 28</i>
Product Registration	<i>Page 31</i>

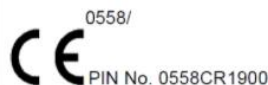

Solus Decor UK / EU
020.8 819.1495
info@solusdecor.co.uk
<https://www.solusdecor.co.uk>

Solus Decor North America
1.877.255.3146
info@solusdecor.com
<https://www.solusdecor.com>

Solus Decor Spain
034.938.00.4927
info@solusdecor.co.es
<https://www.solusdecor.co.es>

inspired, designed, certified and proudly built in Canada

January 2022

This user manual contains information that is critical to the installation and operations of your Solus Fire Pits. For safety, please follow these instructions carefully.

This fire pit conform to the following standards:

ANSI Z21.97 – 2004 / CSA 2.41 -2017 *Outdoor Decorative Gas Appliance*

CSA 2.17-2017 *Gas-Fired Appliances For Use at High Altitudes*

CE BS EN 498:2012 *Specification for Dedicated Liquefied Petroleum Gas Appliances*

CE BS EN 509:2001 + A1 : 2003 + A2: 2004 *Decorative Fuel-Effect Gas Appliances*

Made in Canada by Solus Decor Inc.
Building C-109 Braid Street, New Westminster, BC Canada V3L5H4
1.877.255.3146 www.solusdecor.com

PRODUCT RATINGS

GAS RATINGS

Natural Gas (NG)

Inlet Gas Pressure : 7 "W.C. (17.4mbar) (0.25 PSi)

Manifold Gas Pressure :

<u>Burner Ratings</u>	<u>Minimum Manifold Pressure Requirement</u>
60,000 BTU (17.58kW)	3.5"W.C. (8.7mbar) (0.12 PSi)
73,500 BTU (21.39kW)	3.5"W.C. (8.7mbar) (0.12 PSi)
108,000 BTU (31.65kW)	2.5"W.C. (6.2 mbar) (0.09 PSi)

ELECTRICAL RATINGS

North America : 120vAC, 60Hz, 1.5 Amp

Operating Ranges : 108vAC - 132vAC

UK/EU : 230vAC, 50Hz, 1.5 Amp



Operating Ranges : 220vAC - 240vAC for **UK/EU**

WARNINGS:

Consistent *Inlet Gas Pressure* is required to avoid weak pilot flame and burner dropouts.

Stable *Voltage Supply* is required to avoid ignition module lockout.

PRODUCT WARNINGS

 DANGER	<p style="text-align: center;">CARBON MONOXIDE HAZARD</p> <p>This appliance can produce carbon monoxide which has no odor.</p> <p>Using it in an enclosed space can kill you.</p> <p>Never use this appliance in an enclosed space such as a camper, tent, car or home.</p>
	



DANGER: If you smell gas:

- 1) Shut off gas to the appliance.
- 2) Extinguish any open flame.
- 3) If the odor continues, keep away from appliances and immediately call the gas supplier or fire department.



WARNING: For Outdoor Use Only



WARNING: Only Licensed Gas Fitters and Electricians are allowed to install and perform repair services on this fire pit



WARNING: This Fire pit should be inspected before use and at least once annually by a qualified technician.



WARNING: This manual contains information critical to the safe installation and operation of the fire pit



WARNING: Never alter product or configuration in any way



WARNING: Fuel line sizing and or/regulations are the responsibility of the installer and must be able to supply the stated Product Ratings.



WARNING: Testing for leaks after installation is the responsibility of the installer.



WARNING: All fire pits must have a gas shutoff outside of the exterior of the fire pit to allow for emergency shut off and maintenance.



WARNING: All fire pits with an electric start system, must have an electrical shut off (wall switch or breaker) on the exterior of the fire pit or on an adjacent wall to allow for emergency shutdown and maintenance.



WARNING: Improper installation, adjustment, alteration, service, or maintenance can cause injury or property damage. Read the installation, operating, and maintenance instructions thoroughly before installing or servicing this equipment



WARNING: Improper installation, adjustment, alteration, service, or maintenance can cause injury or property damage. Read the installation, operating, and maintenance instructions thoroughly before installing or servicing this equipment



WARNING: Improper installation, adjustment, alteration, service, or maintenance can cause injury or property damage. Read the installation, operating, and maintenance instructions thoroughly before installing or servicing this equipment.



WARNING: Do not use this fire pit if any part of it has been under water. Call a licensed technician to inspect the fire pit and replace the parts under water as necessary



WARNING: Do not store or use gasoline or other flammable near the fire pit.



WARNING: It is the installer's responsibility to ensure a safe installation and to educate the end user about proper operation. Leave this manual with the end user



WARNING: FOR REMOTE CONTROL USE: To prevent accidental start-up from unwanted RF signals it is the responsibility of the end user to turn off power to the electric outlet for the remote control receiver when the fire-pit is not in use via wall switch or breaker.



WARNING: This fire pit is not intended to be a starter for wood or any other combustibles.



WARNING: Select a location where the fire pit can be attended during operation. Never leave an operating fire pit unattended or by someone not familiar with its operation or emergency shut off locations.



WARNING: Both children and adults should be alerted to the hazards of high surface temperatures and should stay away to avoid burns and clothing ignition.



WARNING: Young children should be carefully supervised when they are in the area of the fire pit.



WARNING: Clothing or other flammable materials should not be placed on or near a fire pit.



WARNING: This fire pit emits very high temperatures - Combustibles must be located far enough away that there is no risk of ignition.



WARNING: All Solus vessels for Natural and Liquid Propane Gas are vented at the bottom. The ventilation allows for heat and/or residual fuel to escape. The vents also function as a drain to prevent water build-up. These vents must not be blocked or tampered with at any time. Failure to follow this instruction may result in the fire-pit overheating or explosion. Overheating could also lead to heat damage to internal components.



WARNING: The interior void space of the Solus vessel surrounding the gas valve and electrical box cannot be filled with any material (gravel, crushed rock, concrete, etc.) to allow for proper ventilation.



WARNING: Solus concrete vessels are HEAVY. Use care and caution during lifting, positioning and repositioning to prevent injury, damage to fire pits and damage to property. Some Fire Pits will require 2 or more people to lift; some may require 4 or more people. The Fire Pit must be evenly supported and level – Shim appropriately as required.



WARNING: The fire pit must be serviced annually by a professional certified in your jurisdiction.



WARNING: Installer must confirm the appliance is built for the appropriate gas used – natural gas or LP. Do not use natural gas appliances with LP or LP appliances with natural gas. Refer to the label on the appliance.



WARNING: To prevent damage, unhook the fire pit from the gas supply for pressure leak tests.



WARNING: Gas Plumbing Connections: Use only joint compound or tape that is resistant to all gases. Apply joint compound to all male pipe fittings only- DO NOT use on FLARED fittings. Be sure to tighten every joint securely.



WARNING: An LP-cylinder not connected for use shall not be stored in the vicinity of this or any other appliance

LOCATION OF THE FIRE PIT

All Solus Decor fire pits are intended and designed for **Outdoor Use Only**.

Stable Surface

The Solus fire pit vessel must be placed on a stable and flat surface. Select a location with good drainage that allows easy access for installation and maintenance of the fire pit.

Consider the location with less unfavorable winds

Solus Burner is designed to withstand 10MPH (16.0934KPH) wind speed. Consider purchasing a Solus WindShield if the location is prone to severe and unpredictable wind activities like open beachfront spaces or high rise building patios and balconies.

WARNINGS:

Consistent *Inlet Gas Pressure* is required to avoid weak pilot flame and burner dropouts.

Stable *Voltage Supply* is required to avoid ignition module lockout.

NOTE:

All jurisdictions have differing requirements for installation.
THIS IS GENERAL SCHEMATIC ONLY

Please review your local building code requirements and adjust as required

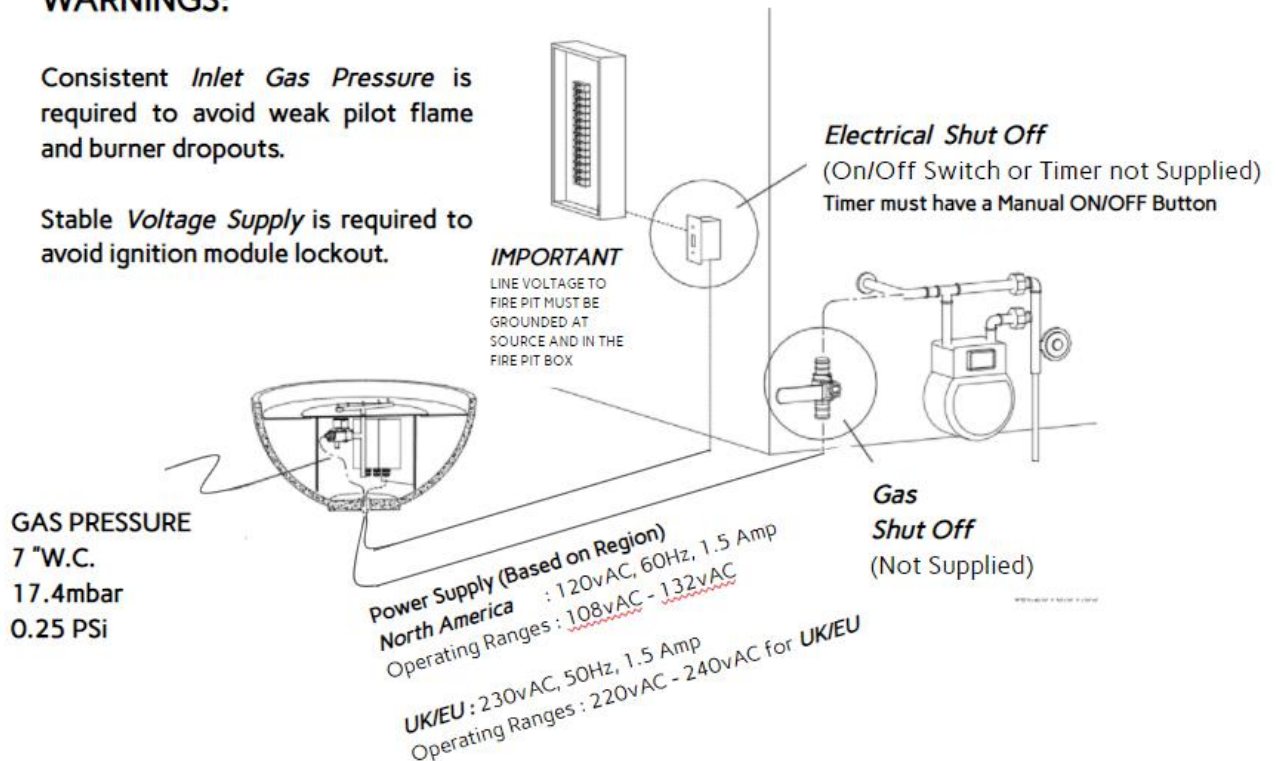

Gas Shut Off

All Fire pits must have a gas shut-off mechanism located outside of the appliance. This gas shut-off mechanism must be accessible for emergency shut-off and maintenance. Please note that the Key Ball Valve outside the vessel of this firepit is not a shut-off mechanism. This Key Ball Valve is used to regulate the flame height and flame intensity.

Electrical Shut Off

All Fire pits with electronic ignitions must have an External shut-off switch (ON/OFF switch or timer) near the fire pit. This electrical switch/timer must be accessible for emergency shut-off and maintenance. **Timer must have a Manual ON/OFF Button.** Please refer to the local electrical and building codes prior to installation of the switch.

FIRE PIT CLEARANCES

Horizontal Clearance

Concrete vessels must be at least 16 inches (0.5 meter) away from any combustible structure and/or materials.

Vertical Clearance

Clearance between the burner and any structure overhead must be at least 77 inches (1.95 meter) from any combustible structure and/or materials.

UNPACKING



The fire pit will arrive in an exquisite crate, fully foamed padded. Carefully inspect the crate for damages during delivery. Open the crate immediately if any damages are observed. Document the damages through photographs and report to Solus Decor at once.

Crate Check

Customers are required to report any crate damages within 24 hours of receiving the crates.

Contents Check

Furthermore, it is the customer's responsibility to check it's contents within 48 hours from receipt of the shipment to check for content damages.

Solus is not responsible for damages reported beyond these timelines.

GENERAL LIFTING GUIDE

WARNING:

These concrete products are heavy and bulky. Moving these concrete products may require multiple people. Refer to the table on the next page.



Please note that only Hemi 36 and 48 bowls are provided with straps that act like a carrying harness.

Product Type	Lbs	Kgs	Number of Person Needed to Lift
Hemi 26	81	37	2
Hemi 36	156	71	2 (Strap Attached)
Hemi 48	317	144	4 (Strap Attached)
Halo 36 Low Base	76	35	2
Halo 36 Low Top	244	111	2-3
EHA 36 Box	230	105	2-3
EHA 36 Top	244	111	2-3
Halo Low 48 Base	75	34	2
Halo Low 48 Top	526	239	5
EHA 48 Box	230	105	2
EHA 48 Top	526	239	4-5
Fire Table Base	74	34	2
Fire Table Box	243	110	2-3
Fire Table Top	134	61	2
Firebox 30	243	110	2-3
Firecube with Lid	156	71	2
Tavolo Base	75	34	2
Tavolo Box	243	110	3-4
Tavolo Top	410	186	4
Linear	148 per slab	67 per slab	2

INSTALLATION AND OPERATION

WARNING:

Installation and repair must be done by Licensed Gas Fitters. The fire pit must be inspected before use and at least checked or serviced annually by a qualified service technician. Cleaning may be required frequently as necessary. When a fire pit is not in use, an all-weather cover or metal top must be used to avoid water and moisture build-up and to protect the fire pit from environmental hazards.

- **Fire Pit Ratings :** Check the Output BTU Ratings of the fire pit and ensure the following requirements are followed.

Gas Rating (NG) :

Inlet Gas Pressure : **7 "W.C. (17.4mbar) (0.25 PSi)**

Manifold Gas Pressure :

<u>Burner Ratings</u>	<u>Minimum Manifold Pressure Requirement</u>
60,000 BTU (17.58kW)	3.5"W.C. (8.7mbar) (0.12 PSi)
73,500 BTU (21.39kW)	3.5"W.C. (8.7mbar) (0.12 PSi)
108,000 BTU (31.65kW)	2.5"W.C. (6.2 mbar) (0.09 PSi)

Electrical Rating

North America : **120vAC, 60Hz, 1.5 Amp**

Operating Ranges : 108vAC - 132vAC

EU/UK : **230vAC, 50Hz, 1.5 Amp**

Operating Ranges : 220vAC - 240vAC for EU/UK

- **Inlet Pressure :** This is the input gas pressure coming from the main gas line going to the fire pit. Reading must be taken only after all other gas appliances on the main supply are on and running at full capacity.
- **Manifold Pressure:** This is the pressure at the manifold when the burner is on.

- **Gas Requirement :** Consistent *Inlet Gas Pressure* is required to avoid weak pilot flame and burner dropouts. **THIS IS AN ABSOLUTE PRIORITY.** The reading must be recorded and written on the installer’s card and must be given to the owner/end user. Owner’s must keep this card for future use and servicing.
- **Electrical Requirement :** Stable *Voltage Supply* is required to avoid ignition module lockout.



Locate all the components

- Installer's Package
- 3" Valve Keys
- 1/2" Yellow Flex Line
- Auto Burner Assembly with Dual Gas Valve
- Concrete Bowl – Ball Valve

Auto Burner Assembly

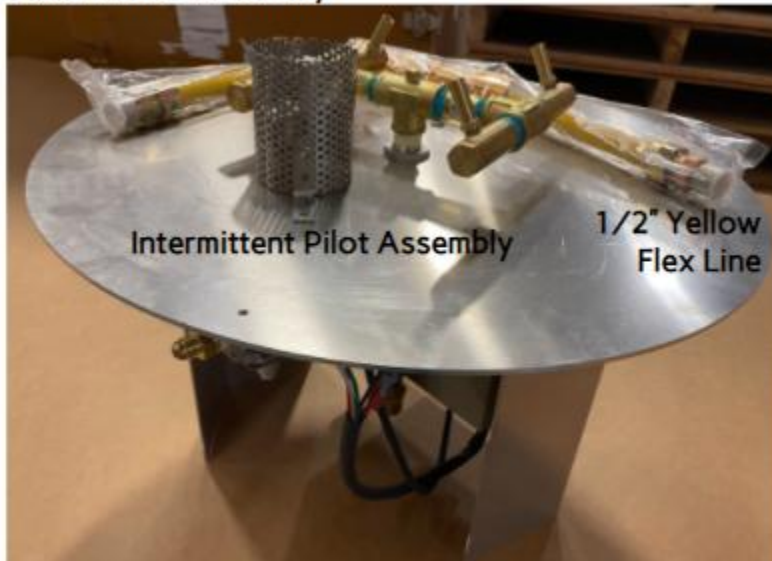

Gas Connection

- Make sure that the gas shut-off valve (emergency shut-off valve) of the appliance is closed when connecting the gas lines.
- Locate the Ball Valve inside the concrete bowl/vessel. This valve is supplied with flared fitting at both ends.
- Connect the one end of the yellow flex gas line (supplied) to the one end of the Ball Valve and the other end to the Dual Solenoid Gas Valve (underneath the burner assembly).
- Connect the end of the NG main supply line to the end of the Ball Valve.
- Test all gas piping and connections for leaks after gas connections
- Do not use an open flame to check for leaks.

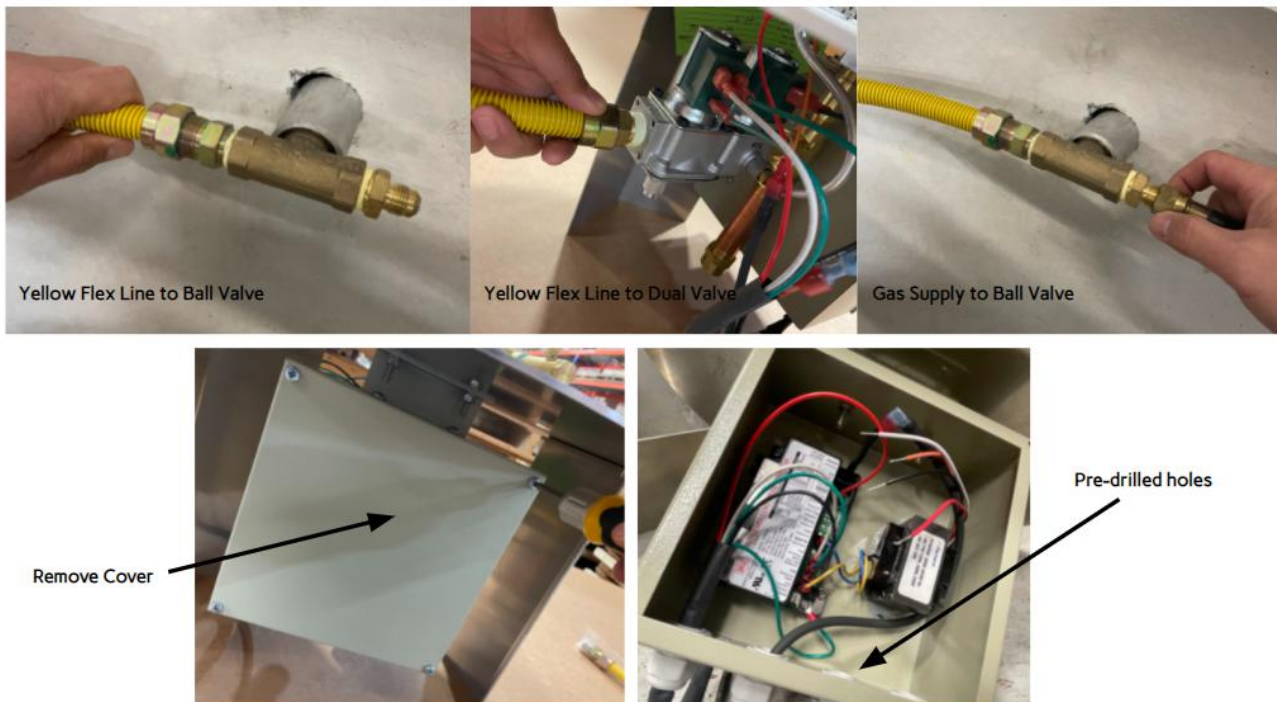

Electrical Connection

- Make sure the electrical switch/timer is off.
- In the Electronic Box, take the cover screws off to access the electronic panel.
- Run the supply line from the shut-off switch/timer through the pre-drilled holes at the bottom of the box.
- Follow the wiring diagram on the next page.

EU/UK
Orange - Input Voltage 230VAC (LIVE)
White - Ground/Neutral

North America
Black - Input Voltage 120VAC (HOT)
White - Ground/Neutral

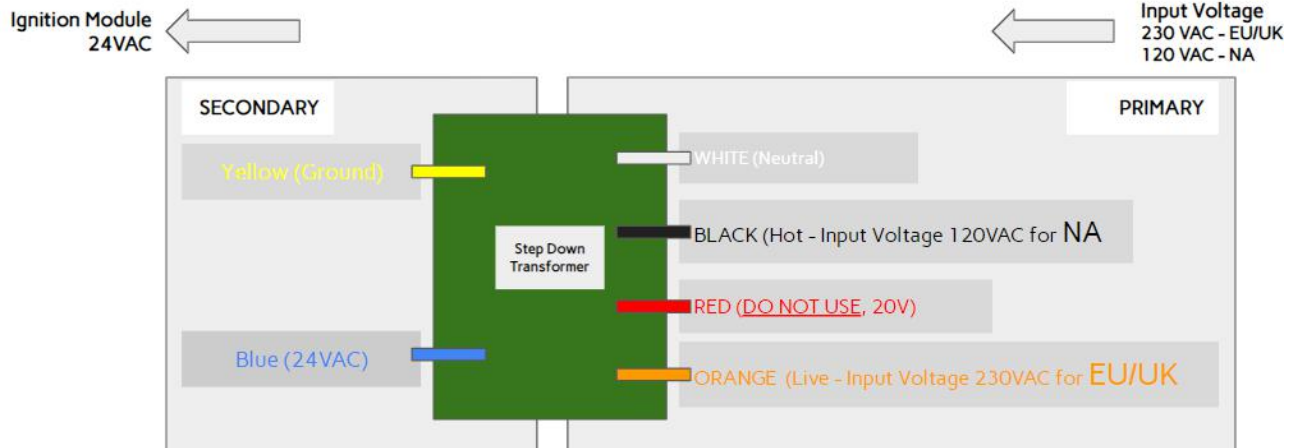

Operation

Turning ON the Electronic Ignition System - NG

- Read instructions very carefully.
- Remove any covers prior to operation.
- Confirm that the gas shut-off valve (emergency shut-off valve) is open.
- Locate the Ball Valve and the electrical shut-off switch/timer.

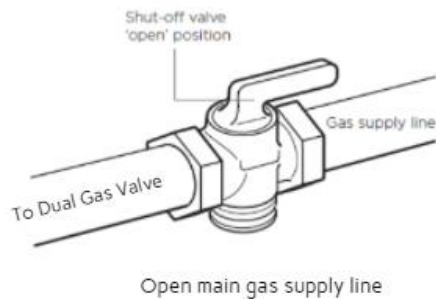

Ignition

By using the 3" Key (supplied), fully open the Ball Valve freely by turning the shaft counter-clockwise. Turn on the electrical shut-off switch/timer (not supplied) to initiate electronic ignition operation. The sparker will try to ignite the pilot for about 7 seconds until it is lit. Once the pilot is lit, the thermosensor is heated and sends a signal to the main gas valve to initiate release of gas to the main burner. Fully purged gas lines will light up the burner manifold immediately.

Purging the line

Failure of the system to detect gas flow and flame after the first ignition cycle will result in the system going to stand-by mode. Sometimes, due to in-activity and not being used, bleeding or purging of air out of the lines is needed to encourage gas flow. To do this, the system needs to be restarted several times until the whole gas line is saturated with gas. To restart the system, turn on the electrical switch and initiate the ignition process. Once the sparker stops igniting the pilot, turn the switch off, and then on again to initiate another ignition cycle. Do this until the pilot is lit and the burner manifold starts to gather flame.

Flame Adjustment

Adjust the flame height and intensity by turning the Ball Valve using a 3" key (provided). Turn the key clockwise to decrease and turn anti-clockwise to increase flame height. Please note that the Ball valve must be fully open prior to ignition and must be fully closed when not in operation.

Turning OFF the Electronic Ignition System - NG

- Turn the electrical switch/timer off
- Shut the Ball Valve off by turning the shaft clockwise using the 3" Key
- Close the gas shut-off valve (emergency shut-off valve).
- Allow the burner to cool down before installing the cover, if available.

WARNINGS:

*Consistent Inlet Gas Pressure is required to avoid weak pilot flame and burner dropouts.
Stable Voltage Supply is required to avoid ignition module lockout.*

MEDIA INSTALLATION

WARNING:

Do not install any refractory stones (decorative river rocks) or lava rocks that are not supplied by Solus Decor. Landscape stones and other natural materials may explode when heated.



Lava Rock



Refractory Stones

WARNINGS:

Do not dump media over the burner and or the nozzles.

Keep the pilot cage free and clear of any refractory stones and lava rocks.



WARNING:

Improper media installation may cause regressed pilot flame, burner ignition issue or can damage the thermocouple and thermosensor.

Lava Rock Bed

Cover the entire burner plate with lava rock. Add enough layers of lava rocks until it reaches the underside of the burner. **Do not cover the nozzles with lava rocks.** Make sure no dust or other particles are inside the nozzles prior to lighting. When a fire pit is equipped with a Pilot Assembly, make sure that there are no lava rocks inside the pilot cage.



Refractory Stone Placement

A small pool of decorative river rocks should be placed on and around the burner. Make sure that no rocks are blocking any of the burner nozzles. Rearrange these stones around to deflect flame into a natural appearance, this is referred to as Flame Sculpting.



GENERAL CARE AND MAINTENANCE

KEEP THE FIRE PIT COVERED WHEN NOT IN USE

Ensure that gas and power (when applicable) are shut off and the fire pit is cool before performing any service and maintenance.

We recommend that a qualified service technician performs the following maintenance procedure at the beginning of each fire pit season.

Cleaning the Burner Nozzles

Periodic check, inspection and cleaning of the burner assembly is recommended. This is to avoid unusual and unwanted flame behaviour as well as ignition failure. To clean the burner nozzles, remove the refractory stones and lava rocks to allow access to the burner. Use a scotch green pad or 320 grit sandpaper or a brush to scrape soot and remove any dust, spider web or any particles. To check for nozzle clogs, use a small paper clip or needle and carefully insert in the burner nozzles. Remove any clogs if any.

Cleaning of Pilot Assembly

A clean and clear pilot assembly is important to the operation of the fire pit. Pilot not lighting, gas valve not opening, gas flow not initiating, flame dropouts, to name a few are common occurrences of a dirty and un-maintained pilot assembly. Hence regular inspection and maintenance is recommended.

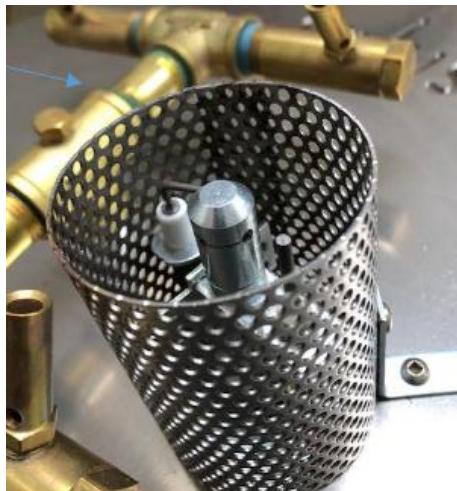

Components of the Pilot Assembly

1. Pilot Nozzle

Remove the pilot cage carefully. By using a knife or any sharp blade, remove any build-up along the 1/16" slit of the nozzles. Purge the debris or dust off using compressed air or using a vacuum cleaner.



2. Inlet Orifice

The Pilot Orifice can be removed from the bottom of the pilot assembly (bottom of burner plate) using a 7/16 wrench. Clean the two (2) tiny holes on top of the Inlet Orifice and ensure that you can see through the 2 tiny holes.

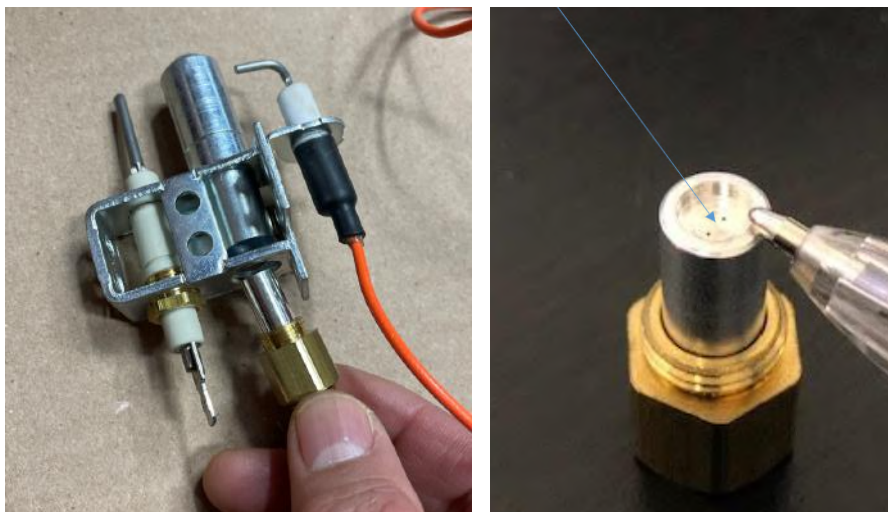

3. Thermosensor

Use a scotch green pad or 320 grit sandpaper to buff and clean the tip of metal stem of the thermosensor



END OF THE SEASON CHECKLIST

When the fire pit is not going to be used for months (although it can be enjoyed year round), it is important to follow this end of the season checklist.

Shut off Main Gas Supply and Electrical Switch

This is to avoid accidental ignition.

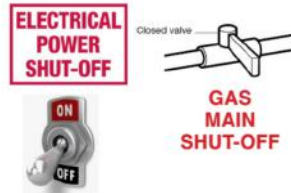

Accessories

Remove all accessories like metal/wood tops and glass shield and store indoors



Unwanted debris

Check and remove any unwanted debris that can affect the look of your concrete fire pit.

Clean exterior of the fire pit

Moisture, dirt, dust and other surface contaminants must be wiped and cleaned. Use warm water and soap.

Pilot Assembly

Check and remove any debris inside the pilot cage. Any debris can trap moisture during storage and can result to clogged and blocked pilot orifice

Cover your firepit

This is to protect your investment.



START OF THE SEASON CHECKLIST

The end of the season checklist is developed so fire pits can be used when the next opportunity happens. If the recommendations were followed, this fire pit should be as good as ready.

Remove Cover.

Solus provided all-weather covers are water resistant. Check the burner/pilot assembly and media for moisture. If they are wet, allow the components to dry. Please see the troubleshooting guide for instructions.

Inspect Gas and Supply Lines.

Inspect all connections and switches prior to operation. Treat this as a new installation. Look for open wires, debris, and kinks along the gas lines.

Inspect Burner.

A clogged and dirty burner nozzle can cause so many different issues. It restricts and blocks gas flow. Check and clean each nozzle when necessary. Water inside the nozzles can also cause the same issue. If water is suspected to have entered the burner and the piping system, contact a licensed gas fitter to drain water from the system.

Inspect Pilot Assembly .

A weak and absence of pilot flame during ignition is commonly caused by dirty pilot assembly. Check and clean each component when necessary using a steel brush and sandpaper. Please see basic care and maintenance instructions

Test Run.

If this fire pit wasn't used for more than one month, please treat this as a new installation and follow the "Turning on" instructions in this manual. Purging of air might be needed.

Clean the exteriors.

Clean the fire pit's exterior and get ready to enjoy another season of outdoor living. Use a hot soapy water, let it dry, then apply a stone sealer or enhancer (available in most DIY shops).
Caution : Apply/Test on a small area before applying fully.

TROUBLESHOOTING

WARNING:

Turn off the fire pit and let it cool before servicing. Only qualified technicians should service and repair the fire pit.

Electric Start - Common Issues		
Issues	Possible Causes	Solutions
No Spark - No Pilot Flame	No power	Check power supply
	Ignition Module on Stand-by Mode	Incorrect Input Voltage / Call an Electrician and correct Input Voltage
System sparks but pilot won't light	No gas flow / gas supply and valve as off	Check Main Gas Shut off and the ball valve are open
	Air in the gas line	Purge air from the line/check installation manual
	Water and moisture in the line	Vacuum the nozzles to remove moisture Remove the condensation chamber cap to release water
	Dirty or damaged inlet orifice	Clean or replace pilot inlet orifice/Follow General Care and Maintenance Procedure
	Pilot is clogged and dirty	Clean pilot assembly/ Follow General Care and Maintenance Procedure
	Detached pilot tube	Secure the connection between gas valve and pilot assembly
	Inlet gas pressure too low	Verify Inlet Gas Pressure is within recommended ranges, check regulator settings if supplied, adjust accordingly
	Strong Wind	Install a glass shield / Make sure that the condition is appropriate for use
	Dual Gas Valve Damaged	Replace Dual Gas Valve / Contact a technician
There is pilot flame but does not stay lit	Dirty or broken thermosensor	Clean pilot assembly / Contact gas fitter to replace damaged parts
	Misaligned thermosensor	Align the thermosensor
	Thermosensor loose or disconnected	Secure the connection between the thermosensor and the gas valve / Contact gas fitter to establish connections
	Strong Wind	Install a glass shield / Make sure that the condition is appropriate for use

	Incorrect gas pressure	Verify Inlet Gas Pressure is within recommended ranges, adjust if needed
	Dirty Inlet Orifice	Clean the Orifice / Follow General Care and Maintenance Procedure
	Dirty Pilot Assembly	Clean pilot assembly / Follow General Care and Maintenance Procedure
Steady pilot flame but burner does not light	Inlet gas pressure too low	Contact a technician. Verify Inlet Gas Pressure is within recommended ranges, check regulator settings if supplied, adjust accordingly
	Small / weak pilot flame	Clean Pilot Assembly / Follow General Care and Maintenance Procedure Contact a technician. Verify Inlet Gas Pressure is within recommended ranges, check regulator settings if supplied, adjust accordingly
	Dirty thermosensor	Clean thermosensor / Follow General Care and Maintenance Procedure
	Misaligned thermosensor	Align the thermosensor
	Thermosensor loose or disconnected	Secure the connection between the thermosensor and the gas valve / Contact gas fitter to establish connections
	Clogged or Dirty Burner Nozzles	Clean nozzles and check for obstruction
	Main burner lights but drops out intermittently	Inlet gas pressure too low
Small / weak pilot flame		Clean Pilot Assembly / Follow General Care and Maintenance Procedure Contact a technician. Verify Inlet Gas Pressure is within recommended ranges, check regulator settings if supplied, adjust accordingly.
Dirty thermosensor		Clean thermosensor / Follow General Care and Maintenance Procedure
Misaligned thermosensor		Align the thermosensor
Thermosensor loose		Secure the connection between the thermosensor and the gas valve
Strong Wind		Install a glass shield / Make sure that the condition is appropriate for use

WARRANTY INFORMATION

Solus warrants that each Solus Fire Pits conforms to CSA, ANSI, CE and UKCA standards for *Outdoor Decorative Gas Appliance*. All concrete products are professionally inspected and passed Solus' above industry quality standard, and each and every gas burner burned and fire tested prior to leaving the Solus facility in Vancouver.

This warranty is voided if the fire pit is not installed by a licensed technician and if not maintained and operated according to the installation and user's manual. This warranty is also voided if product is modified, altered and tampered with and if a third-party parts and components were used during repair and maintenance.

Warranties are limited to the original purchaser only.

Upon Receipt of the Crate

Solus spares no expense on packaging these fire pits. These products are crated and packed to museum quality standards. However, things can happen along the way. The purchaser, upon receipt of the crate, must visually inspect the crate for damages. Report any crate damages to Solus within 24 hours. Additionally, the content of the crate must be visually inspected within 48 hours. Report to Solus immediately. Solus is not responsible to any damages not reported beyond the specified timelines

Parts Only Limited Warranty

Solus will, at its election, repair or replace the part or product where Solus inspection discloses any such defect occurring with normal usage. Solus will replace all warranted parts free of charge. Client is responsible for the cost of shipping, duties and custom charges when applicable as well as the service and labour cost, re-installation and disposal of the replaced parts and components.

Solus does not provide onsite repair, visits or service.

This warranty does not cover damages to parts and products caused by inappropriate or improper installation, unauthorized modifications to the burner, vessel and parts, and improper maintenance such as failure to put the all-weather cover or metal top when fire pit is not in use.

Concrete Vessels Limited Warranty

Solus concrete products weather and tarnish through exposure to natural elements over time. This naturally occurring process is called Patina.

It is a very rare occasion that a vessel will fracture. Solus will replace cracked and broken concrete vessels resulting from structural defects. Client is responsible for any costs associated with crating, shipping, handling, re-installation labour or disposal of replaced products or components.

Non-structural hairline and spider web-like cracks, surface air voids, chips, scratches and abrasions or minor dimples will not affect the quality and performance of the fire pit therefore shall not be covered by this Warranty. Damages due to excessive loads, for example: Solus fire tables and bowls are not designed for seating purposes and are also not covered by this Warranty.

Any slight variation from the samples received, surface discoloration, texture changes and stains due to exposure to elements like salts, acids, birds droppings, insects, spilled drinks, greasy food and other harmful liquids also is not covered by this Warranty.

General Exclusions

This Warranty also excludes damages to the fire pit occurring due to accident, fire exposure, damages caused by wind and flooding, vandalism, ground movement, neglect, misuse and

Warranty Summary

Type	Components	No cover or metal tabletop purchased	Solus All-Weather cover and/or metal tabletop purchased
Electronic Ignition Fire Features	Brass Burner and brass fittings	5 years	25 years
	Concrete Vessels	1 year	5 years
	Dual Solenoid Valve	1 year	3 years
	Intermittent Pilot Assembly	1 year	3 years
	Sensor Assembly	1 year	3 years
	Ignition Control	1 year	3 years

PARTS LIST

Parts Number	Parts Description
P02085	3" Key
P02185	Ball Valve
P01985	Ball Valve & Flange
P02180	1/2" Yellow Flex Line (36")
P02182	1/2" Yellow Flex Line (26")
P01992	Burner Nozzles (NG 10K)
P01987	Burner Manifold (NG) 60,000 BTU - 4 NZ crossfire
P01968	Burner Manifold (NG) 73,500 BTU - 5 NZ crossfire
P01988	Burner Manifold (NG) 108,000 BTU - 12 NZ crossfire
P02072	Solus (NG) MLS Burner Package
A01820	Pilot Cage
P02009	Universal Pilot with Inlet - NG
P02004	1/4" Pilot Tubing
P02001	NG Inlet Orifice (3223)
P01999	Inlet Fitting with Compression
P01994	Dual Solenoid Gas Valve
P02000	Intermittent Pilot Assembly (NG)
P02006	Thermosensor
P01998	Ignition Control
P02017	Transformer
P02007	Spark Wire
P02010	Wiring Harness
P02074	Solus (NG) AUTO Burner Package
P02075	Solus (NG) ADJ AUTO Burner Package
A01829	NG to LP / ELEC Conversion Kit (Includes P02020)
P02023	Quick Connect Assembly

ACCESSORIES

All Weather Covers



Metal Table Tops



Hardwood Table Tops



Fire Stones



Glass WindShields



Tank Table



PRODUCT REGISTRATION

Thank you for purchasing a Solus Firepit! To protect your investment, please register your fire pit within 30 days of installation. Please supply all the required information at the time of installation. As noted in our Limited Product Warranty, professional registration number and gas pressure and input voltage readings are required to engage a warranty claim in the unlikely event that one is necessary.

CONTACT INFORMATION:

Name: _____ Organization/Company: _____

Address: _____

Telephone Number: _____ Email: _____

PRODUCT INFORMATION: (please retain proof-of-purchase)

Order #: _____ Firepit Model: _____ Fuel type: Natural Gas Propane Ethanol

Ignition type: Manual Light Manual Light w/Flame Supervision Valve Automatic (Electronic)

Date purchased: _____ Date of Install: _____

Product purchased: Solus directly Specifier / Contractor Reseller

BURNER SERIAL # _____

Gas Fitter Name: _____

Gas Fitter Registration #: _____

Gas Fitter Signature: _____

Date Signed: _____

Inlet Gas Pressure Reading : _____

Test Completed : Yes ____ / No: ____

Electrician Name: _____

Electrician Registration #: _____

Electrician Signature: _____

Date Signed: _____

Input Voltage Reading: _____

Test Completed : Yes ____ / No: ____

How to submit the completed Product Registration Form?

North America - Return to:

*Solus Decor Inc
Building C- 109 Braid St
New Westminster, BC V3L 5H4
Canada*

Or scan and email to info@solusdecor.com

Or complete online at: www.solusdecor.com/warranty

UK/EU/Spain - Return to:

*Solus Decor Ltd - UK
Horsley Rd, East Horsley,
Cobham, KT11 3JX,
United Kingdom*

Or scan and email to info@solusdecor.com

Or complete online at: www.solusdecor.co.uk/warranty

MANUAL LIT SYSTEM

Liquefied Petroleum Gas (LPG)

60,000 BTU



fire pit installation and user manual

CONTENTS

Standards	<i>Page 2</i>
Product Ratings	<i>Page 2</i>
Product Warnings	<i>Page 3</i>
Location of the Fire Pit	<i>Page 6</i>
Fire Pit Clearances	<i>Page 6</i>
Unpacking	<i>Page 7</i>
General Lifting Guide	<i>Page 8</i>
Installation and Operation	<i>Page 10</i>
Media Installation	<i>Page 14</i>
General Care and Maintenance	<i>Page 16</i>
End of the Season Checklist	<i>Page 17</i>
Start of the Season Checklist	<i>Page 18</i>
Troubleshooting	<i>Page 19</i>
Warranty Information	<i>Page 20</i>
Parts List	<i>Page 22</i>
Optional Accessories	<i>Page 22</i>
Product Registration	<i>Page 25</i>



inspired, designed, certified and proudly built in Canada
1.877.255.3146:info@solusdecor.com
<https://www.solusdecor.com/>



This user manual contains information that is critical to the installation and operations of your Solus Fire Pits. For safety, please follow these instructions carefully.

This fire pit conform to the following standards:

ANSI Z21.97 – 2004 / CSA 2.41 -2017 *Outdoor Decorative Gas Appliance*

CSA 2.17-2017 *Gas-Fired Appliances For Use at High Altitudes*

CE BS EN 498:2012 *Specification for Dedicated Liquefied Petroleum Gas Appliances*

CE BS EN 509:2001 + A1 : 2003 + A2: 2004 *Decorative Fuel-Effect Gas Appliances*

Made in Canada by Solus Decor Inc.
Building C-109 Braid Street, New Westminster, BC Canada V3L5H4
1.877.255.3146 www.solusdecor.com

PRODUCT RATINGS

GAS RATINGS

Liquified Petroleum Gas (LPG)

Inlet Gas Pressure : 11"W.C. (27.37 mbar) (0.39 PSi)



Manifold Gas Pressure :

<u>Burner Ratings</u>	<u>Minimum Manifold Pressure Requirement</u>
60,000 BTU (17.58kW)	10.8 "W.C. (26.8mbar) (0.39 PSi)
73,500 BTU (21.39kW)	10.8 "W.C. (26.8mbar) (0.39 PSi)
108,000 BTU (31.65kW)	4.5 "W.C. (11.2 mbar) (0.16 PSi)

WARNING: Consistent *Inlet Gas Pressure* is required to avoid weak pilot flame and burner dropouts.





PRODUCT WARNINGS

 DANGER	CARBON MONOXIDE HAZARD This appliance can produce carbon monoxide which has no odor. Using it in an enclosed space can kill you. Never use this appliance in an enclosed space such as a camper, tent, car or home.
	

 **DANGER:** If you smell gas:
1) Shut off gas to the appliance.
2) Extinguish any open flame.
3) If the odor continues, keep away from appliances and immediately call the gas supplier or fire department.

 **WARNING:** For Outdoor Use Only

 **WARNING:** Only Licensed Gas Fitters and Electricians are allowed to install and perform repair services on this fire pit

 **WARNING:** This Fire pit should be inspected before use and at least once annually by a qualified technician.

 **WARNING:** This manual contains information critical to the safe installation and operation of the fire pit

 **WARNING** Never alter product or configuration in any way

 **WARNING:** Fuel line sizing and or/regulations are the responsibility of the installer and must be able to supply the stated Product Ratings.

 **WARNING:** Testing for leaks after installation is the responsibility of the installer.



WARNING: All fire pits must have a gas shutoff outside of the exterior of the fire pit to allow for emergency shut off and maintenance.



WARNING: All fire pits with an electric start system, must have an electrical shut off (wall switch or breaker) on the exterior of the fire pit or on an adjacent wall to allow for emergency shutdown and maintenance.



WARNING: Improper installation, adjustment, alteration, service, or maintenance can cause injury or property damage. Read the installation, operating, and maintenance instructions thoroughly before installing or servicing this equipment



WARNING: Improper installation, adjustment, alteration, service, or maintenance can cause injury or property damage. Read the installation, operating, and maintenance instructions thoroughly before installing or servicing this equipment



WARNING: Improper installation, adjustment, alteration, service, or maintenance can cause injury or property damage. Read the installation, operating, and maintenance instructions thoroughly before installing or servicing this equipment.



WARNING: Do not use this fire pit if any part of it has been under water. Call a licensed technician to inspect the fire pit and replace the parts under water as necessary



WARNING: Do not store or use gasoline or other flammable near the fire pit.



WARNING: It is the installer's responsibility to ensure a safe installation and to educate the end user about proper operation. Leave this manual with the end user



WARNING: FOR REMOTE CONTROL USE: To prevent accidental start-up from unwanted RF signals it is the responsibility of the end user to turn off power to the electric outlet for the remote control receiver when the fire-pit is not in use via wall switch or breaker.



WARNING: This fire pit is not intended to be a starter for wood or any other combustibles.



WARNING: Select a location where the fire pit can be attended during operation. Never leave an operating fire pit unattended or by someone not familiar with its operation or emergency shut off locations.



WARNING: Both children and adults should be alerted to the hazards of high surface temperatures and should stay away to avoid burns and clothing ignition.



WARNING: Young children should be carefully supervised when they are in the area of the fire pit.



WARNING: Clothing or other flammable materials should not be placed on or near a fire pit.



WARNING: This fire pit emits very high temperatures - Combustibles must be located far enough away that there is no risk of ignition.



WARNING: All Solus vessels for Natural and Liquid Propane Gas are vented at the bottom. The ventilation allows for heat and/or residual fuel to escape. The vents also function as a drain to prevent water build-up. These vents must not be blocked or tampered with at any time. Failure to follow this instruction may result in the fire-pit overheating or explosion. Overheating could also lead to heat damage to internal components.



WARNING: The interior void space of the Solus vessel surrounding the gas valve and electrical box cannot be filled with any material (gravel, crushed rock, concrete, etc.) to allow for proper ventilation.



WARNING: Solus concrete vessels are HEAVY. Use care and caution during lifting, positioning and repositioning to prevent injury, damage to fire pits and damage to property. Some Fire Pits will require 2 or more people to lift; some may require 4 or more people. The Fire Pit must be evenly supported and level – Shim appropriately as required.



WARNING: The fire pit must be serviced annually by a professional certified in your jurisdiction.



WARNING: Installer must confirm the appliance is built for the appropriate gas used – natural gas or LP. Do not use natural gas appliances with LP or LP appliances with natural gas. Refer to the label on the appliance.



WARNING: To prevent damage, unhook the fire pit from the gas supply for pressure leak tests.



WARNING: Gas Plumbing Connections: Use only joint compound or tape that is resistant to all gases. Apply joint compound to all male pipe fittings only- DO NOT use on FLARED fittings. Be sure to tighten every joint securely.



WARNING: An LP-cylinder not connected for use shall not be stored in the vicinity of this or any other appliance

LOCATION OF THE FIRE PIT

All Solus Decor fire pits are intended and designed for **Outdoor Use Only**.

Stable Surface

The Solus fire pit vessel must be placed on a stable and flat surface. Select a location with good drainage that allows easy access for installation and maintenance of the fire pit.

Consider the location with less unfavorable winds

Solus Burner is designed to withstand 10MPH (16.0934KPH) wind speed. Consider purchasing a Solus WindShield if the location is prone to severe and unpredictable wind activities like open beachfront spaces or high rise building patios and balconies.

Gas Shut Off

All Fire pits must have a gas shut-off mechanism located outside of the appliance. This gas shut-off mechanism must be accessible for emergency shut-off and maintenance. Please note that the Key Valve outside the vessel of this firepit is not a shut-off mechanism. This Key Valve is used to regulate the flame height and flame intensity.

FIRE PIT CLEARANCES

WARNING: Keep away from combustible materials

Horizontal Clearance

Concrete vessels must be at least 16 inches (0.5 meter) away from any combustible structure and/or materials.

Vertical Clearance

Clearance between the burner and any structure overhead must be at least 77 inches (1.95 meter) from any combustible structure and/or materials.

UNPACKING



The fire pit will arrive in an exquisite crate, fully foamed padded. Carefully inspect the crate for damages during delivery. Open the crate immediately if any damages are observed. Document the damages through photographs and report to Solus Decor at once.

Crate Check

Customers are required to report any crate damages within 24 hours of receiving the crates.

Contents Check

Furthermore, it is the customer's responsibility to check it's contents within 48 hours from receipt of the shipment to check for content damages.

Solus is not responsible for damages reported beyond these timelines.

GENERAL LIFTING GUIDE

WARNING:

These concrete products are heavy and bulky. Moving these concrete products may require multiple people. Refer to the table on the next page.



Please note that only Hemi 36 and 48 bowls are provided with straps that act like a carrying harness.

Product Type	Lbs	Kgs	Number of Person Needed to Lift
Hemi 26	81	37	2
Hemi 36	156	71	2 (straps attached)
Hemi 48	317	144	4 (straps attached)
Halo 36 Low Base	76	35	2
Halo 36 Low Top	244	111	2-3
EHA 36 Box	230	105	2-3
EHA 36 Top	244	111	2-3
Halo Low 48 Base	75	34	2
Halo Low 48 Top	526	239	5
EHA 48 Box	230	105	2
EHA 48 Top	526	239	4-5
Firetable Base	74	34	2
Firetable Box	243	110	2-3
Firetable Top	134	61	2
Firebox 30	243	110	2-3
Firecube with Lid	156	71	2
Tavolo Base	75	34	2
Tavolo Box	243	110	3-4
Tavolo Top	410	186	4
Linear	148 per slab	67 per slab	2



INSTALLATION and OPERATION

WARNING:

Installation and repair must be done by Licensed Gas Fitters. The fire pit must be inspected before use and at least checked or serviced annually by a qualified service technician. Cleaning may be required frequently as necessary. When a fire pit is not in use, an all-weather cover or metal top must be used to avoid water and moisture build-up and to protect the fire pit from environmental hazards.

- **Fire Pit Ratings** : Check the Output BTU Ratings of the fire pit and ensure the following requirements are followed

Gas Rating (LPG) :

Inlet Gas Pressure : **11"W.C. (27.37 mbar)(0.39 PSI)**

Manifold Gas Pressure

<u>Burner Ratings</u>	<u>Minimum Manifold Pressure Requirement</u>
60,000 BTU (17.58kW)	10.8"W.C. (26.8mbar) (0.39 PSI)

- **Inlet Pressure** : This is the input gas pressure coming from the main gas line going to the fire pit. Reading must be taken only after all other gas appliances on the main supply are on and running at full capacity.
- **Manifold Pressure**: This is the pressure at the manifold when the burner is on.
- **Gas Requirement** : Consistent **Inlet Gas Pressure** is required to avoid burner dropouts. ***THIS IS AN ABSOLUTE PRIORITY.*** The reading must be recorded and written on the installer's card and must be given to the owner/end user. Owner's must keep this card for future use and servicing. The readings must also be included in the product registration form (*page 25 of this manual*).



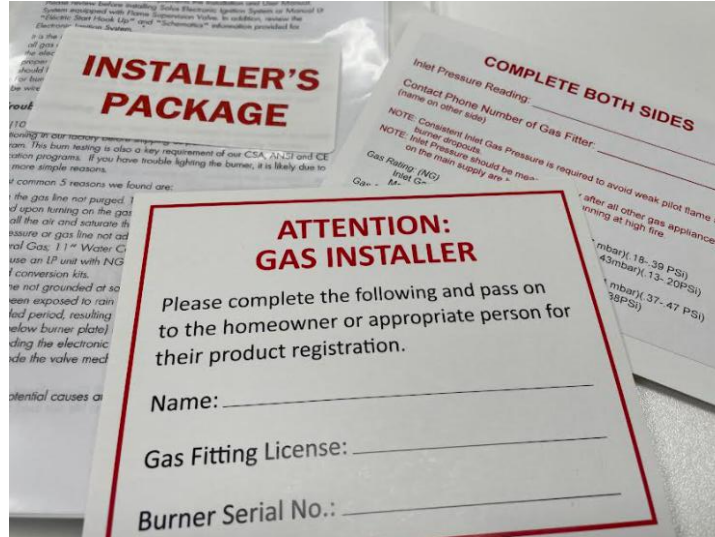

Locate all the components

- Installer's Package
- 3" Valve Keys
- 1/2" Yellow Flex Line
- Burner Assembly
- Concrete Bowl – Ball Valve
- Propane Kit : Gas Regulator with 15' hose (if ordered)

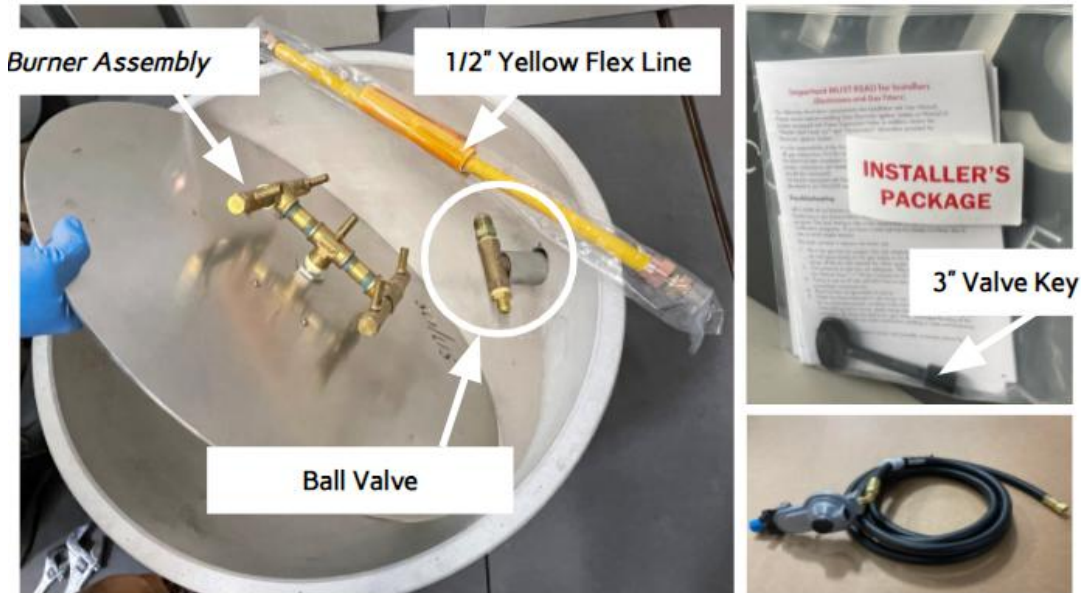

Propane Kit : Gas Regulator with 15' hose (if ordered)

Gas Connection

- Make sure that the LP bottle or tank is closed when connecting the gas lines.
- Locate the Ball Valve inside the concrete bowl/vessel. This valve is supplied with adaptor fittings at both ends
- Connect the one end of the yellow flex gas line (supplied) to one end of the Ball Valve and the other end to the burner manifold.
- Connect the end of the LP hose (supplied if ordered) to the end of the Ball Valve.
- For hard pipe connections: Use a flexible hose to connect the end of the hard pipe to the ball valve using the appropriate fittings.
- Test all gas piping and connections for leaks after gas connections
- Do not use an open flame to check for leaks.

Gas Connection



Yellow Flex Line (One End)
to Ball Valve



Yellow Flex Line (Other End)
to Burner Manifold

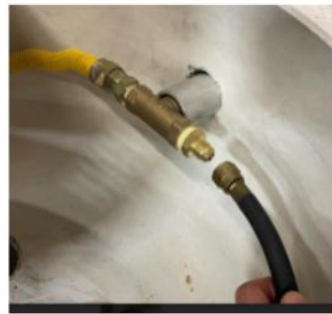

Gas Supply Line to the
Ball Valve



WARNING:

Do not place LP hoses under any wooden and concrete floors.

Operation



inspired, designed, certified and proudly built in Canada
1.877.255.3146:info@solusdecor.com
<https://www.solusdecor.com/>

North America Only

Turning ON the MLS – LP System

- Read instructions very carefully.
- Remove any covers prior to operation.
- Confirm that the LP supply bottle or tank is open.
- Locate the Key Valve.
- By using the 3" Valve Key (supplied), turn the Ball Valve freely counter-clockwise.
- Apply a flame with a barbeque lighter to the closest nozzle on the exterior of the burner.
- Once lit, use the 3" Valve Key to adjust the flame to desired height.



Turning OFF the MLS – LP System

- By using the 3" Valve Key (supplied), turn the valve freely clockwise.
- Make sure flame is totally out
- If using a LP bottle or Tank, turn the shut off valve to closed
- Allow the burner to cool down before installing the cover, if available.

Purging

Sometimes, due to in-activity or if the fire pit just came out of the box or just completed a service, there is a good chance that the system won't detect any gas flow. This is due to the presence of unwanted air or water in the system. Purging is the process of displacing gas/air/water inside the system with LPG. To purge air out of the line, turn the ball valve counterclockwise to open and observe any vapour coming out of the burner nozzles. Once vapour is observed, this means gas flow is already initiated. Apply a flame with a barbeque lighter to the closest nozzle on the exterior of the burner.

MEDIA INSTALLATION

WARNING:

Do not install any refractory stones (decorative river rocks) or lava rocks that are not supplied by Solus Decor. Landscape stones and other natural materials may explode when heated.



Lava Rock



Refractory Stones

WARNING:

Do not dump media over the burner and or the nozzles.

Lava Rock Bed

Cover the entire burner plate with lava rock. Add enough layers of lava rocks until it reaches the underside of the burner. *Do not cover the nozzles with lava rocks.* Make sure no dust or other particles are inside the nozzles prior to lighting.

Keep the jets free and clear of any refractory stones and lava rocks.



Refractory Stone Placement

A small pool of decorative concrete refractory river rocks should be placed on and around the burner. Make sure that no rocks are blocking any of the burner nozzles. Rearrange these stones around to deflect flame into a natural appearance, this is referred to as Flame Sculpting.



GENERAL CARE AND MAINTENANCE

KEEP THE FIRE PIT COVERED WHEN NOT IN USE

Ensure that gas and power (when applicable) are shut off and the fire pit is cool before performing any service and maintenance.

We recommend that a qualified service technician performs the following maintenance procedure at the beginning of each fire pit season.

Cleaning the Burner Nozzles

Periodic check, inspection and cleaning of the burner assembly is recommended. This is to avoid unusual and unwanted flame behaviour as well as ignition failure. To clean the burner nozzles, remove the refractory stones and lava rocks to allow access to the burner. Use a scotch green pad or 320 grit sandpaper or a brush to scrape soot and remove any dust, spider web or any particles. To check for nozzle clogs, use a small paper clip or needle and carefully insert in the burner nozzles. Remove any clogs if any.

END OF THE SEASON CHECKLIST

When the fire pit is not going to be used for months (although it can be enjoyed year round), it is important to follow this end of the season checklist.

Shut off Main Gas Supply



Accessories

Remove all accessories like wood tops, glass shield and propane kit and store indoors



Unwanted debris

Check and remove any unwanted debris that can affect the look of your concrete fire pit.

Clean exterior of the fire pit

Moisture, dirt, dust and other surface contaminants must be wiped and cleaned. Use warm water and soapy water.

Cover your firepit

This is to protect your investment.



START OF THE SEASON CHECKLIST

The end of the season checklist is developed so fire pits can be used when the next opportunity happens. If the recommendations were followed, this fire pit should be as good as ready.

Remove Cover.

Solus provided all-weather covers are water resistant. Check the burner/nozzles and media for moisture. If they are wet, allow the components to dry. Please see the troubleshooting guide for instructions.

Inspect Gas and Supply Lines.

Inspect all gas connections prior to operation. Treat this as a new installation. Look for debris and kinks along the gas lines.

Inspect Burner.

A clogged and dirty burner nozzle can cause so many different issues. It restricts and blocks gas flow. Check and clean each nozzle when necessary. Water inside the nozzles can also

cause the same issue. If water is suspected to have entered the burner and the piping system, contact a licensed gas fitter to drain water from the system.

Test Run.

If this fire pit wasn't used for more than one month, please treat this as a new installation and follow the "Turning on" instructions in this manual. Purging of air might be needed.

Clean the exteriors.

Clean the fire pit's exterior and get ready to enjoy another season of outdoor living. Use a hot soapy water, let it dry, then apply a stone sealer or enhancer (available in most DIY shops). Caution : Apply/Test on a small area before applying fully.

TROUBLESHOOTING

WARNING:

Turn off the fire pit and let it cool before servicing. Only qualified technicians should service and repair the fire pit.

Manual Lit System - Common Issues		
Issues	Possible Causes	Solutions
No Flame	Key Valve Closed	Open ball valve to allow gas flow
	Main Gas Supply Valve Closed	Open Main Gas Supply Valve
	Air in the line	Purge air from the line/check installation manual
	Water and moisture in the line	Vacuum the nozzles to remove moisture/or alternatively, use a hair dryer
Weak or Low Flame	Low Gas Pressure	Verify Gas Pressure/ Check LP Tank
One or more nozzles not lighting or weaker than the other	Clogged or Dirty Burner Nozzles	Clean nozzles and check for obstruction
	Mismatched nozzles used	Check and compare nozzles, replace with correct nozzles if needed
Burner excessively noisy / Whistling	Too much gas pressure/presence of kinks and bends along the gas lines	Contact a technician. Verify Inlet Gas Pressure is within recommended ranges, check regulator settings if supplied, adjust accordingly. Check for kinks and bends
Unwanted Odours	Gas Leak	Shut off gas supply and call a technician



WARRANTY INFORMATION

Solus warrants that each Solus Fire Pits conforms to CSA, ANSI, CE and UKCA standards for *Outdoor Decorative Gas Appliance*. All concrete products are professionally inspected and passed Solus' above industry quality standard, and each and every gas burner burned and fire tested prior to leaving the Solus facility in Vancouver.

This warranty is voided if the fire pit is not installed by a licensed technician and/or if not maintained and operated according to the installation and user's manual. This warranty is also voided if product is modified, altered and tampered with and if a third-party parts and components were used during repair and maintenance.

Warranties are limited to the original purchaser only.

Upon Receipt of the Crate

Solus spares no expense on packaging these fire pits. They are crated and packed to museum quality standards. However, things can happen along the way. The purchaser, upon receipt of the crate, must visually inspect the crate for damages. Report any crate damages to Solus within 24 hours. Additionally, the content of the crate must be visually inspected within 48 hours. Report to Solus immediately. Solus is not responsible to any damages not reported beyond the specified timelines

Parts Only Limited Warranty

Solus will, at its election, repair or replace the part or product where Solus inspection discloses any such defect occurring with normal usage. Solus will replace all warranted parts free of charge. Client is responsible for the cost of shipping, duties and custom charges when applicable as well as the service and labour cost, re-installation and disposal of the replaced parts and components.

Solus does not provide onsite repair, visits or service.

This warranty does not cover damages to parts and products caused by inappropriate or improper installation, unauthorized modifications to the burner, vessel and parts, and improper maintenance such as failure to put the all-weather cover or metal top when fire pit is not in use.

Concrete Vessels Limited Warranty

Solus concrete products weather and tarnish through exposure to natural elements over time. This naturally occurring process is called Patina.



It is a very rare occasion that a vessel will fracture. Solus will replace cracked and broken concrete vessels resulting from structural defects. Client is responsible for any costs associated with crating, shipping, handling, re-installation labour or disposal of replaced products or components.

Non-structural hairline and spider web-like cracks, surface air voids, chips, scratches and abrasions or minor dimples will not affect the quality and performance of the fire pit therefore shall not be covered by this Warranty. Damages due to excessive loads, for example: Solus fire tables and bowls are not designed for seating purposes and are also not covered by this Warranty.

Any slight variation from the samples received, surface discoloration, texture changes and stains due to exposure to elements like salts, acids, birds droppings, insects, spilled drinks, greasy food and other harmful liquids also is not covered by this Warranty.

General Exclusions

This Warranty also excludes damages to the fire pit occurring due to accident, fire exposure, damages caused by wind and flooding, vandalism, ground movement, neglect, misuse and abuse.

Warranty Summary

Type	Components	No cover or metal tabletop purchased	Solus All-Weather cover and/or metal tabletop purchased
Manual Ignition Fire Features	Brass Burner and brass fittings Concrete Vessels	5 years 1 year	25 years 5 years



PARTS LIST

Parts Number	Parts Description
P02085	3" Key
P02185	Ball Valve
P01985	Ball Valve & Flange
P02180	1/2" Yellow Flex Line (36")
P02182	1/2" Yellow Flex Line (26")
P01814	Propane Kit: Gas Regulator with 15' hose
P01990	Burner Nozzles (LP 10K)
P01995	Burner Manifold (LP) 60,000 BTU - 4 NZ crossfire
P02076	Solus (LP) MLS Burner Package
A01816	LP to NG / MLS Conversion Kit
P02023	Quick Connect Assembly

ACCESSORIES

All Weather Covers



Metal Table Tops



Hardwood Table Tops



Fire Stones



Glass WindShields



Tank Table



PRODUCT REGISTRATION

Thank you for purchasing a Solus Firepit! To protect your investment, please register your fire pit within 30 days of installation. Please supply all the required information at the time of installation. As noted in our Limited Product Warranty, professional registration number and gas pressure and input voltage readings are required to engage a warranty claim in the unlikely event that one is necessary.

CONTACT INFORMATION:

Name: _____ Organization/Company: _____

Address: _____

Telephone Number: _____ Email: _____

PRODUCT INFORMATION: (please retain proof-of-purchase)

Order #: _____ Firepit Model: _____ Fuel type: Natural Gas Propane Ethanol

Ignition type: Manual Light Manual Light w/Flame Supervision Valve Automatic (Electronic)

Date purchased: _____ Date of Install: _____

Product purchased: Solus directly Specifier / Contractor Reseller

BURNER SERIAL # _____

Gas Fitter Name: _____ Gas Fitter Registration #: _____

Gas Fitter Signature: _____ Date Signed: _____

Inlet Gas Pressure Reading : _____ Test Completed : Yes _____ / No: _____

How to submit the completed Product Registration Form?

North America - Return to:

Solus Decor Inc
 Building C- 109 Braid St
 New Westminster, BC V3L 5H4
 Canada
 Or scan and email to info@solusdecor.com
 Or complete online at: www.solusdecor.com/warranty



inspired, designed, certified and proudly built in Canada
 1.877.255.3146: info@solusdecor.com
<https://www.solusdecor.com/>
North America Only

AUTOMATIC IGNITION w/ Adjustable Flame

Liquified Petroleum Gas (LPG)

60,000 BTU; 73,500 BTU; 108,000 BTU



fire pit installation and user manual

CONTENTS

Standards	<i>Page 2</i>
Product Ratings	<i>Page 2</i>
Product Warnings	<i>Page 3</i>
Location of the Fire Pit	<i>Page 6</i>
Fire Pit Clearances	<i>Page 7</i>
Unpacking	<i>Page 7</i>
General Lifting Guide	<i>Page 8</i>
Installation and Operation	<i>Page 10</i>
Media Installation	<i>Page 16</i>
General Care and Maintenance	<i>Page 18</i>
End of the Season Checklist	<i>Page 21</i>
Start of the Season Checklist	<i>Page 22</i>
Troubleshooting	<i>Page 23</i>
Warranty Information	<i>Page 25</i>
Parts List	<i>Page 27</i>
Optional Accessories	<i>Page 28</i>
Product Registration	<i>Page 31</i>

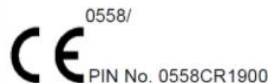

Solus Decor UK / EU
020.8.819.1495
info@solusdecor.co.uk
<https://www.solusdecor.co.uk>

Solus Decor North America
1.877.255.3146
info@solusdecor.com
<https://www.solusdecor.com>

Solus Decor Spain
034.938.00.4927
info@solusdecor.co.es
<https://www.solusdecor.co.es>

inspired, designed, certified and proudly built in Canada

January 2022

This user manual contains information that is critical to the installation and operations of your Solus Fire Pits. For safety, please follow these instructions carefully.

This fire pit conform to the following standards:

ANSI Z21.97 – 2004 / CSA 2.41 -2017 *Outdoor Decorative Gas Appliance*

CSA 2.17-2017 *Gas-Fired Appliances For Use at High Altitudes*

CE BS EN 498:2012 *Specification for Dedicated Liquefied Petroleum Gas Appliances*

CE BS EN 509:2001 + A1 : 2003 + A2: 2004 *Decorative Fuel-Effect Gas Appliances*

Made in Canada by Solus Decor Inc.

Building C-109 Braid Street, New Westminster, BC Canada V3L5H4

1.877.255.3146 www.solusdecor.com

PRODUCT RATINGS

GAS RATINGS:

Liquified Petroleum Gas (LPG)

Inlet Gas Pressure : 11"W.C. (27.37 mbar) (0.39 PSI)

Manifold Gas Pressure :

<u>Burner Ratings</u>	<u>Minimum Manifold Pressure Requirement</u>
60,000 BTU (17.58kW)	10.8 "W.C. (26.8mbar) (0.39 PSI)
73,500 BTU (21.39kW)	10.8 "W.C. (26.8mbar) (0.39 PSI)
108,000 BTU (31.65kW)	4.5 "W.C. (11.2mbar) (0.16 PSI)

ELECTRICAL RATINGS

North America : 120vAC, 60Hz, 1.5 Amp

Operating Ranges : 108vAC - 132vAC

UK/EU : 230vAC, 50Hz, 1.5 Amp



Operating Ranges : 220vAC - 240vAC for **UK/EU**

WARNINGS:

Consistent *Inlet Gas Pressure* is required to avoid weak pilot flame and burner dropouts.

Stable *Voltage Supply* is required to avoid ignition module lockout.

PRODUCT WARNINGS

 DANGER	<p style="text-align: center;">CARBON MONOXIDE HAZARD</p> <p>This appliance can produce carbon monoxide which has no odor.</p> <p>Using it in an enclosed space can kill you.</p> <p>Never use this appliance in an enclosed space such as a camper, tent, car or home.</p>
	

 **DANGER:** If you smell gas:
1) Shut off gas to the appliance.
2) Extinguish any open flame.
3) If the odor continues, keep away from appliances and immediately call the gas supplier or fire department.

 **WARNING:** For Outdoor Use Only

 **WARNING:** Only Licensed Gas Fitters and Electricians are allowed to install and perform repair services on this fire pit

 **WARNING:** This Fire pit should be inspected before use and at least once annually by a qualified technician.

 **WARNING:** This manual contains information critical to the safe installation and operation of the fire pit

 **WARNING:** Never alter product or configuration in any way

 **WARNING:** Fuel line sizing and or/regulations are the responsibility of the installer and must be able to supply the stated Product Ratings.

 **WARNING:** Testing for leaks after installation is the responsibility of the installer.

 **WARNING:** All fire pits must have a gas shutoff outside of the exterior of the fire pit to allow for emergency shut off and maintenance.



WARNING: All fire pits with an electric start system, must have an electrical shut off (wall switch or breaker) on the exterior of the fire pit or on an adjacent wall to allow for emergency shutdown and maintenance.



WARNING: Improper installation, adjustment, alteration, service, or maintenance can cause injury or property damage. Read the installation, operating, and maintenance instructions thoroughly before installing or servicing this equipment



WARNING: Improper installation, adjustment, alteration, service, or maintenance can cause injury or property damage. Read the installation, operating, and maintenance instructions thoroughly before installing or servicing this equipment



WARNING: Improper installation, adjustment, alteration, service, or maintenance can cause injury or property damage. Read the installation, operating, and maintenance instructions thoroughly before installing or servicing this equipment.



WARNING: Do not use this fire pit if any part of it has been under water. Call a licensed technician to inspect the fire pit and replace the parts under water as necessary



WARNING: Do not store or use gasoline or other flammable near the fire pit.



WARNING: It is the installer's responsibility to ensure a safe installation and to educate the end user about proper operation. Leave this manual with the end user



WARNING: FOR REMOTE CONTROL USE: To prevent accidental start-up from unwanted RF signals it is the responsibility of the end user to turn off power to the electric outlet for the remote control receiver when the fire-pit is not in use via wall switch or breaker.



WARNING: This fire pit is not intended to be a starter for wood or any other combustibles.



WARNING: Select a location where the fire pit can be attended during operation. Never leave an operating fire pit unattended or by someone not familiar with its operation or emergency shut off locations.



WARNING: Both children and adults should be alerted to the hazards of high surface temperatures and should stay away to avoid burns and clothing ignition.



WARNING: Young children should be carefully supervised when they are in the area of the fire pit.



WARNING: Clothing or other flammable materials should not be placed on or near a fire pit.



WARNING: This fire pit emits very high temperatures - Combustibles must be located far enough away that there is no risk of ignition.



WARNING: All Solus vessels for Natural and Liquid Propane Gas are vented at the bottom. The ventilation allows for heat and/or residual fuel to escape. The vents also function as a drain to prevent water build-up. These vents must not be blocked or tampered with at any time. Failure to follow this instruction may result in the fire-pit overheating or explosion. Overheating could also lead to heat damage to internal components.



WARNING: The interior void space of the Solus vessel surrounding the gas valve and electrical box cannot be filled with any material (gravel, crushed rock, concrete, etc.) to allow for proper ventilation.



WARNING: Solus concrete vessels are HEAVY. Use care and caution during lifting, positioning and repositioning to prevent injury, damage to fire pits and damage to property. Some Fire Pits will require 2 or more people to lift; some may require 4 or more people. The Fire Pit must be evenly supported and level – Shim appropriately as required.



WARNING: The fire pit must be serviced annually by a professional certified in your jurisdiction.



WARNING: Installer must confirm the appliance is built for the appropriate gas used – natural gas or LP. Do not use natural gas appliances with LP or LP appliances with natural gas. Refer to the label on the appliance.



WARNING: To prevent damage, unhook the fire pit from the gas supply for pressure leak tests.



WARNING: Gas Plumbing Connections: Use only joint compound or tape that is resistant to all gases. Apply joint compound to all male pipe fittings only- DO NOT use on FLARED fittings. Be sure to tighten every joint securely.



WARNING: An LP-cylinder not connected for use shall not be stored in the vicinity of this or any other appliance

LOCATION OF THE FIRE PIT

All Solus Decor fire pits are intended and designed for **Outdoor Use Only**.

Stable Surface

The Solus fire pit vessel must be placed on a stable and flat surface. Select a location with good drainage that allows easy access for installation and maintenance of the fire pit.

Consider the location with less unfavorable winds

Solus Burner is designed to withstand 10MPH (16.0934KPH) wind speed. Consider purchasing a Solus WindShield if the location is prone to severe and unpredictable wind activities like open beachfront spaces or high rise building patios and balconies.

NOTE:

All jurisdictions have differing requirements for installation.
THIS IS GENERAL SCHEMATIC ONLY

Please review your local building code requirements and adjust as required

WARNINGS:

Consistent *Inlet Gas Pressure* is required to avoid weak pilot flame and burner dropouts.

Stable *Voltage Supply* is required to avoid ignition module lockout.

Gas Shut Off

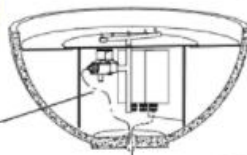
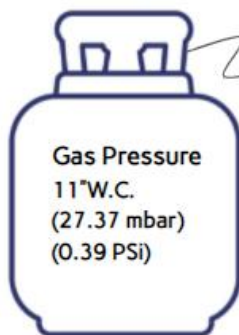

IMPORTANT
LINE VOLTAGE TO
FIRE PIT MUST BE
GROUNDED AT
SOURCE AND IN THE
FIRE PIT BOX

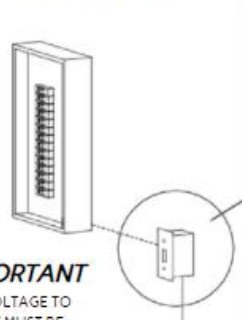

Electrical Shut Off
(On/Off Switch or Timer not Supplied)
Timer must have a Manual ON/OFF Button

Power Supply (Based on Region)
North America : 120vAC, 60Hz, 1.5 Amp
Operating Ranges : 108vAC - 132vAC
UK/EU : 230vAC, 50Hz, 1.5 Amp
Operating Ranges : 220vAC - 240vAC for UK/EU

Gas Shut Off

All Fire pits must have a gas shut-off mechanism located outside of the appliance. This gas shut-off mechanism must be accessible for emergency shut-off and maintenance. Please note that the Key Ball Valve outside the vessel of this firepit is not a shut-off mechanism. This Key Ball Valve is used to regulate the flame height and flame intensity.

Electrical Shut Off

All Fire pits with electronic ignitions must have an External shut-off switch (ON/OFF switch or timer) near the fire pit. This electrical switch/timer must be accessible for emergency shut-off and maintenance. **Timer must have a Manual ON/OFF Button.** Please refer to the local electrical and building codes prior to installation of the switch.

FIRE PIT CLEARANCES

Horizontal Clearance

Concrete vessels must be at least 16 inches (0.5 meter) away from any combustible structure and/or materials.

Vertical Clearance

Clearance between the burner and any structure overhead must be at least 77 inches (1.95 meter) from any combustible structure and/or materials.

UNPACKING

The fire pit will arrive in an exquisite crate, fully foamed padded. Carefully inspect the crate for damages during delivery. Open the crate immediately if any damages are observed. Document the damages through photographs and report to Solus Decor at once.

Crate Check

Customers are required to report any crate damages within 24 hours of receiving the crates.

Contents Check

Furthermore, it is the customer's responsibility to check it's contents within 48 hours from receipt of the shipment to check for content damages.

Solus is not responsible for damages reported beyond these timelines.



GENERAL LIFTING GUIDE

WARNING:

These concrete products are heavy and bulky. Moving these concrete products may require multiple people. Refer to the table on the next page.



Please note that only Hemi 36 and 48 bowls are provided with straps that act like a carrying harness.

Product Type	Lbs	Kgs	Number of Person Needed to Lift
Hemi 26	81	37	2
Hemi 36	156	71	2 (Strap Attached)
Hemi 48	317	144	4 (Strap Attached)
Halo 36 Low Base	76	35	2
Halo 36 Low Top	244	111	2-3
EHA 36 Box	230	105	2-3
EHA 36 Top	244	111	2-3
Halo Low 48 Base	75	34	2
Halo Low 48 Top	526	239	5
EHA 48 Box	230	105	2
EHA 48 Top	526	239	4-5
Firetable Base	74	34	2
Firetable Box	243	110	2-3
Firetable Top	134	61	2
Firebox 30	243	110	2-3
Firecube with Lid	156	71	2
Tavolo Base	75	34	2
Tavolo Box	243	110	3-4
Tavolo Top	410	186	4
Linear	148 per slab	67 per slab	2

INSTALLATION AND OPERATION

WARNING:

Installation and repair must be done by Licensed Gas Fitters. The fire pit must be inspected before use and at least checked or serviced annually by a qualified service technician. Cleaning may be required frequently as necessary. When a fire pit is not in use, an all-weather cover or metal top must be used to avoid water and moisture build-up and to protect the fire pit from environmental hazards.

- **Fire Pit Ratings :** Check the Output BTU Ratings of the fire pit and ensure the following requirements are followed.

Gas Rating (LPG) :

Inlet Gas Pressure : **11"W.C. (27.37 mbar)(0.39 PSI)**

Manifold Gas Pressure

<u>Burner Ratings</u>	<u>Minimum Manifold Pressure Requirement</u>
60,000 BTU (17.58kW)	10.8"W.C. (26.8mbar) (0.39 PSI)
73,500 BTU (21.39kW)	10.8"W.C. (26.8mbar) (0.39 PSI)
108,000 BTU (31.65kW)	4.5 "W.C. (11.2 mbar) (0.16 PSI)

Electrical Rating

North America : **120vAC, 60Hz, 1.5 Amp**

Operating Ranges : 108vAC - 132vAC

EU/UK : **230vAC, 50Hz, 1.5 Amp**

Operating Ranges : 220vAC - 240vAC for EU/UK

- **Inlet Pressure :** This is the input gas pressure coming from the main gas line going to the fire pit. Reading must be taken only after all other gas appliances on the main supply are on and running at full capacity.
- **Manifold Pressure:** This is the pressure at the manifold when the burner is on.

- **Gas Requirement :** Consistent **Inlet Gas Pressure** is required to avoid burner dropouts. **THIS IS AN ABSOLUTE PRIORITY.** The reading must be recorded and written on the installer’s card and must be given to the owner/end user. Owner’s must keep this card for future use and servicing. The readings must also be included in the product registration form (*page 30 of this manual*). .
- **Electrical Requirement :** **Stable Voltage Supply** is required to avoid ignition module lockout.



Locate all the components

- Installer's Package
- 3" Valve Keys
- 1/2" Yellow Flex Line
- Auto Burner Assembly with Dual Gas Valve
- Concrete Bowl – Ball Valve
- Propane Kit : Gas Regulator with 15' hose (if ordered)

Auto Burner Assembly

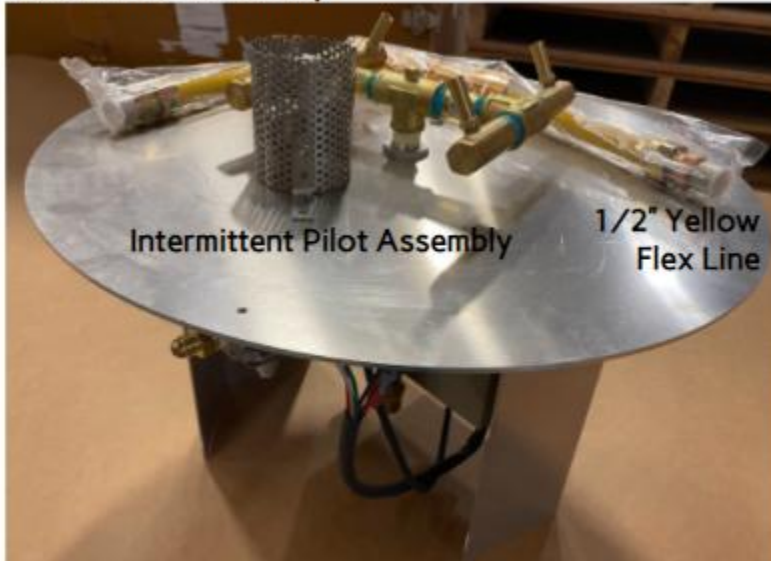

Gas Connection

- Make sure that the LP bottle or tank is closed when connecting the gas lines.
- Locate the Ball Valve inside the concrete bowl/vessel. This valve is supplied with adaptor fittings at both ends
- Connect the one end of the yellow flex gas line (supplied) to one end of the Ball Valve and the other end to the burner manifold.
- Connect the end of the LP hose (supplied if ordered) to the end of the Ball Valve.
- For hard pipe connections: Use a flexible hose to connect the end of the hard pipe to the ball valve using the appropriate fittings.
- Test all gas piping and connections for leaks after gas connections
- Do not use an open flame to check for leaks.

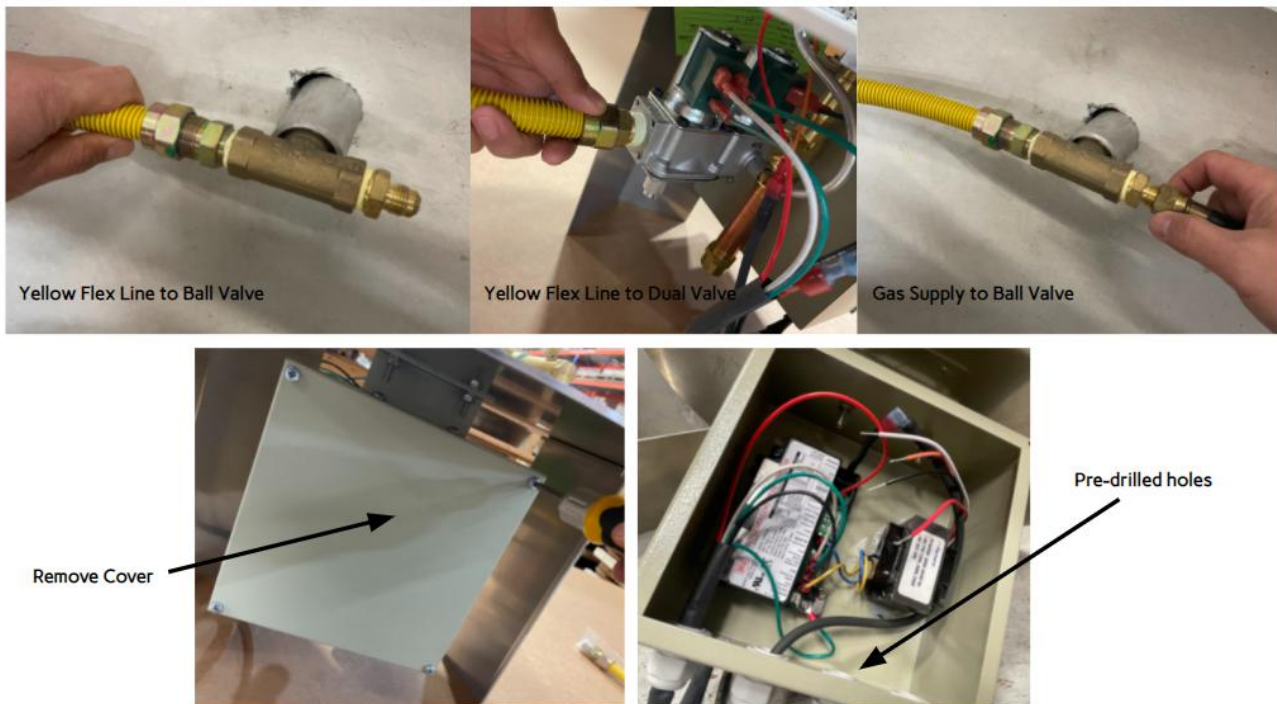

Electrical Connection

- Make sure the electrical switch/timer is off.
- In the Electronic Box, take the cover screws off to access the electronic panel.
- Run the supply line from the shut-off switch/timer through the pre-drilled holes at the bottom of the box.
- Follow the wiring diagram on the next page.

EU/UK
Orange - Input Voltage 230VAC (LIVE)
White - Ground/Neutral

North America
Black - Input Voltage 120VAC (HOT)
White - Ground/Neutral

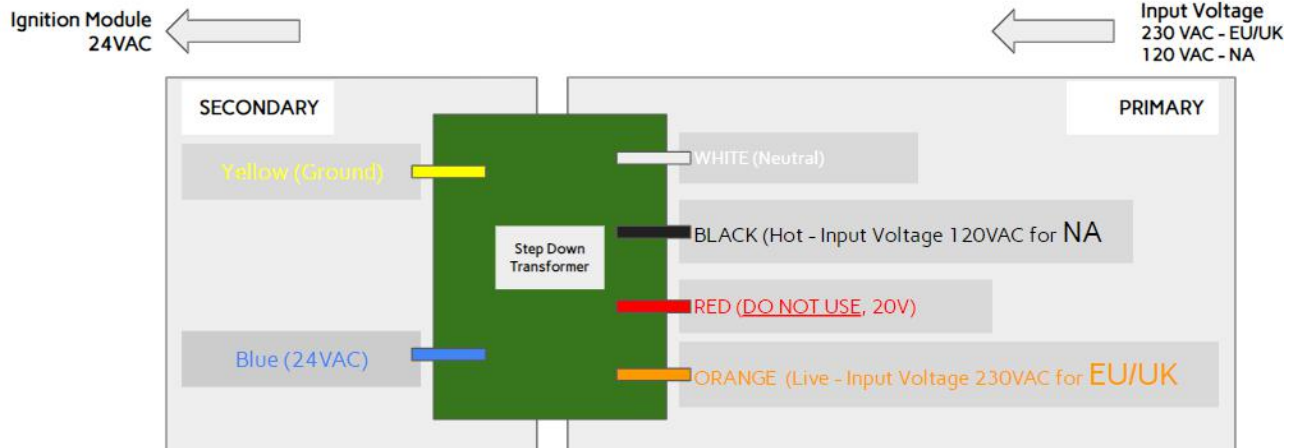

Operation

Turning ON the Electronic Ignition System - LP

- Read instructions very carefully.
- Remove any covers prior to operation.
- Confirm that the LP supply bottle or tank is open
- Locate the Ball Valve and the electrical shut-off switch/timer.

WARNING: Consistent *Inlet Gas Pressure* is required to avoid weak pilot flame and burner dropouts.

Ignition

By using the 3" Valve Key (supplied), fully open the Ball Valve freely by turning the shaft counter-clockwise. Turn on the electrical shut-off switch/timer (not supplied) to initiate electronic ignition operation. The sparker will try to ignite the pilot for about 9 seconds until it is lit. Once the pilot is lit, the thermosensor is heated and sends a signal to the main gas valve to initiate release of gas to the main burner. Fully purged gas lines will light up the burner manifold immediately.

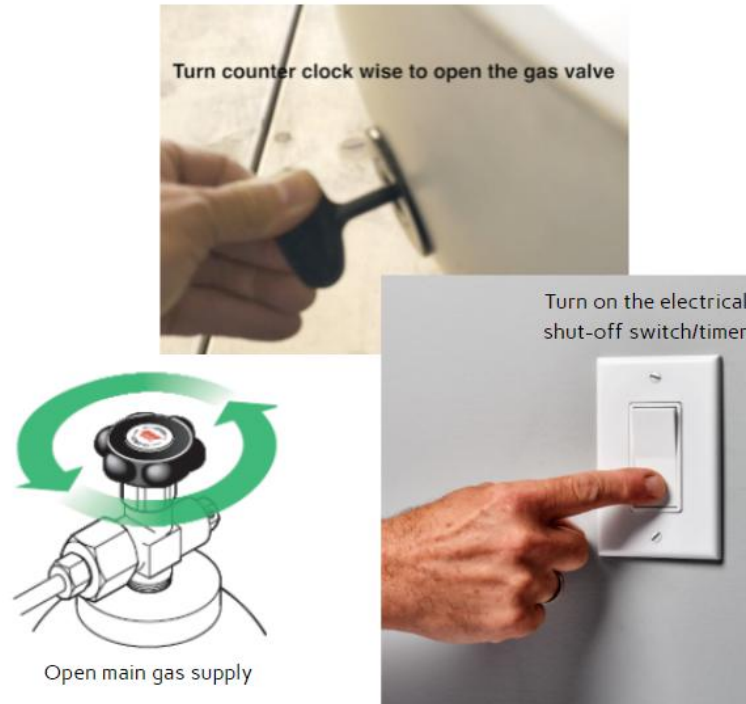

Purging the line

Failure of the system to detect gas flow and flame after the first ignition cycle will result in the system going to stand-by mode. Sometimes, due to in-activity and not being used, bleeding or purging of air out of the lines is needed to encourage gas flow. To do this, the system needs to be restarted several times until the whole gas line is saturated with gas. To start the system, turn on the electrical switch to initiate the ignition process. When no flame is observed, restart the system by turning the switch OFF and then ON to initiate another ignition cycle. Do this until the pilot is lit and the burner manifold starts to gather flame.

Flame Adjustment

Adjust the flame height and intensity by turning the Ball Valve using a 3" Valve key (provided). Turn the key clockwise to decrease and turn anti-clockwise to increase flame height. Please note that the Ball valve must be fully open prior to ignition and must be fully closed when not in operation.

Turning OFF the Electronic Ignition System - LP

- Turn the electrical shut-off switch/timer off.
- Shut the Ball Valve off by turning the shaft clockwise using the 3" Valve Key.
- If using a LP bottle or Tank, turn the knob to close.
- Allow the burner to cool down before installing the cover, if available.

MEDIA INSTALLATION

WARNING:

Do not install any refractory stones (decorative river rocks) or lava rocks that are not supplied by Solus Decor. Landscape stones and other natural materials may explode when heated.



Lava Rock



Refractory Stones

WARNINGS:

Do not dump media over the burner and or the nozzles.

Keep the pilot cage free and clear of any refractory stones and lava rocks.



WARNING:

Improper media installation may cause regressed pilot flame, burner ignition issue or can damage the thermocouple and thermosensor.

Lava Rock Bed

Cover the entire burner plate with lava rock. Add enough layers of lava rocks until it reaches the underside of the burner. **Do not cover the nozzles with lava rocks.** Make sure no dust or other particles are inside the nozzles prior to lighting. When a fire pit is equipped with a Pilot Assembly, make sure that there are no lava rocks inside the pilot cage.



Refractory Stone Placement

A small pool of decorative river rocks should be placed on and around the burner. Make sure that no rocks are blocking any of the burner nozzles. Rearrange these stones around to deflect flame into a natural appearance, this is referred to as Flame Sculpting.



GENERAL CARE AND MAINTENANCE

KEEP THE FIRE PIT COVERED WHEN NOT IN USE

Ensure that gas and power (when applicable) are shut off and the fire pit is cool before performing any service and maintenance.

We recommend that a qualified service technician performs the following maintenance procedure at the beginning of each fire pit season.

Cleaning the Burner Nozzles

Periodic check, inspection and cleaning of the burner assembly is recommended. This is to avoid unusual and unwanted flame behaviour as well as ignition failure. To clean the burner nozzles, remove the refractory stones and lava rocks to allow access to the burner. Use a scotch green pad or 320 grit sandpaper or a brush to scrape soot and remove any dust, spider web or any particles. To check for nozzle clogs, use a small paper clip or needle and carefully insert in the burner nozzles. Remove any clogs if any.

Cleaning of Pilot Assembly

A clean and clear pilot assembly is important to the operation of the fire pit. Pilot not lighting, gas valve not opening, gas flow not initiating, flame dropouts, to name a few are common occurrences of a dirty and un-maintained pilot assembly. Hence regular inspection and maintenance is recommended.



Components of the Pilot Assembly

1. Pilot Nozzle

Remove the pilot cage carefully. By using a knife or any sharp blade, remove any build-up along the 1/16" slit of the nozzles. Purge the debris or dust off using compressed air or using a vacuum cleaner.



2. Inlet Orifice

The Pilot Orifice can be removed from the bottom of the pilot assembly (bottom of burner plate) using a 7/16 wrench. Clean the two (2) tiny holes on top of the Inlet Orifice and ensure that you can see through the 2 tiny holes.

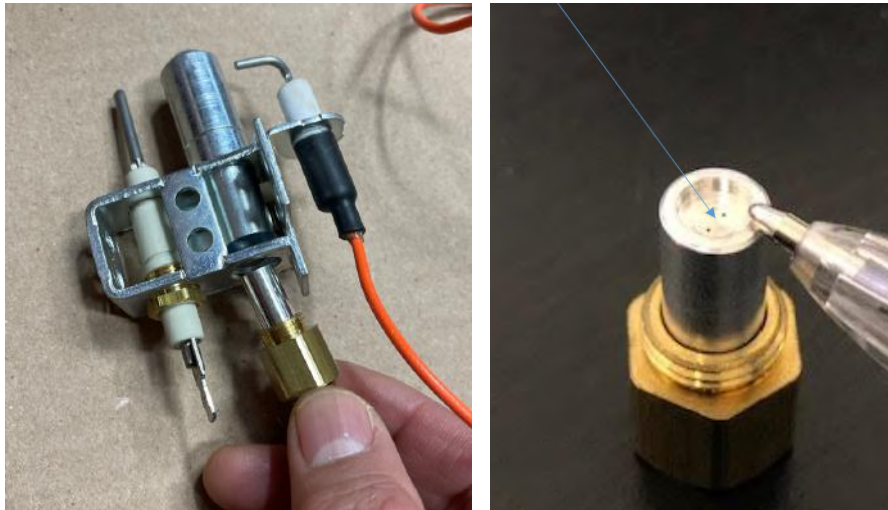

3. Thermosensor

Use a scotch green pad or 320 grit sandpaper to buff and clean the tip of metal stem of the thermosensor

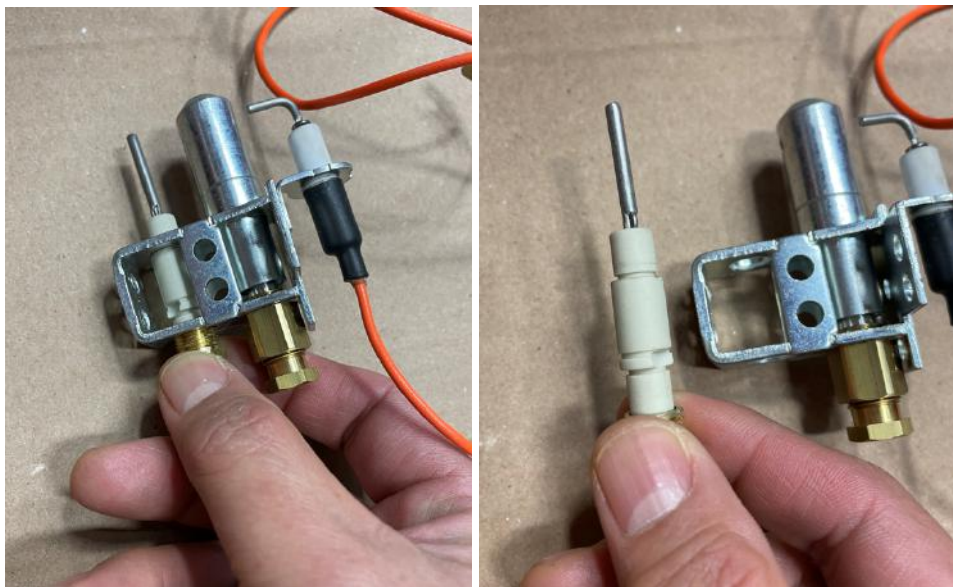

END OF THE SEASON CHECKLIST

When the fire pit is not going to be used for months (although it can be enjoyed year round), it is important to follow this end of the season checklist.

Shut off Main Gas Supply and Electrical Switch

This is to avoid accidental ignition.



Accessories

Remove all accessories like metal/wood tops and glass shield and store indoors



Unwanted debris

Check and remove any unwanted debris that can affect the look of your concrete fire pit.

Clean exterior of the fire pit

Moisture, dirt, dust and other surface contaminants must be wiped and cleaned. Use warm water and soap.

Pilot Assembly

Check and remove any debris inside the pilot cage. Any debris can trap moisture during storage and can result to clogged and blocked pilot orifice

Cover your firepit

This is to protect your investment.



START OF THE SEASON CHECKLIST

The end of the season checklist is developed so fire pits can be used when the next opportunity happens. If the recommendations were followed, this fire pit should be as good as ready.

Remove Cover.

Solus provided all-weather covers are water resistant. Check the burner/pilot assembly and media for moisture. If they are wet, allow the components to dry. Please see the troubleshooting guide for instructions.

Inspect Gas and Supply Lines.

Inspect all connections and switches prior to operation. Treat this as a new installation. Look for open wires, debris, and kinks along the gas lines.

Inspect Burner.

A clogged and dirty burner nozzle can cause so many different issues. It restricts and blocks gas flow. Check and clean each nozzle when necessary. Water inside the nozzles can also cause the same issue. If water is suspected to have entered the burner and the piping system, contact a licensed gas fitter to drain water from the system.

Inspect Pilot Assembly .

A weak and absence of pilot flame during ignition is commonly caused by dirty pilot assembly. Check and clean each component when necessary using a steel brush and sandpaper. Please see basic care and maintenance instructions

Test Run.

If this fire pit wasn't used for more than one month, please treat this as a new installation and follow the "Turning on" instructions in this manual. Purging of air might be needed.

Clean the exteriors.

Clean the fire pit's exterior and get ready to enjoy another season of outdoor living. Use a hot soapy water, let it dry, then apply a stone sealer or enhancer (available in most DIY shops).
Caution : Apply/Test on a small area before applying fully.

TROUBLESHOOTING

WARNING:

Turn off the fire pit and let it cool before servicing. Only qualified technicians should service and repair the fire pit.

Electric Start - Common Issues		
Issues	Possible Causes	Solutions
No Spark - No Pilot Flame	No power	Check power supply
	Ignition Module on Stand-by Mode	Incorrect Input Voltage / Call an Electrician and correct Input Voltage
System sparks but pilot won't light	No gas flow / gas supply and valve as off	Check Main Gas Shut off and the ball valve are open
	Air in the gas line	Purge air from the line/check installation manual
	Water and moisture in the line	Vacuum the nozzles to remove moisture Remove the condensation chamber cap to release water
	Dirty or damaged inlet orifice	Clean or replace pilot inlet orifice/Follow General Care and Maintenance Procedure
	Pilot is clogged and dirty	Clean pilot assembly/ Follow General Care and Maintenance Procedure
	Detached pilot tube	Secure the connection between gas valve and pilot assembly
	Inlet gas pressure too low	Verify Inlet Gas Pressure is within recommended ranges, check regulator settings if supplied, adjust accordingly
	Strong Wind	Install a glass shield / Make sure that the condition is appropriate for use
	Dual Gas Valve Damaged	Replace Dual Gas Valve / Contact a technician
There is pilot flame but does not stay lit	Dirty or broken thermosensor	Clean pilot assembly / Contact gas fitter to replace damaged parts
	Misaligned thermosensor	Align the thermosensor

	Thermosensor loose or disconnected	Secure the connection between the thermosensor and the gas valve / Contact gas fitter to establish connections
	Strong Wind	Install a glass shield / Make sure that the condition is appropriate for use
	Incorrect gas pressure	Verify Inlet Gas Pressure is within recommended ranges, adjust if needed
	Dirty Inlet Orifice	Clean the Orifice / Follow General Care and Maintenance Procedure
	Dirty Pilot Assembly	Clean pilot assembly / Follow General Care and Maintenance Procedure
Steady pilot flame but burner does not light	Inlet gas pressure too low	Contact a technician. Verify Inlet Gas Pressure is within recommended ranges, check regulator settings if supplied, adjust accordingly
	Small / weak pilot flame	Clean Pilot Assembly / Follow General Care and Maintenance Procedure Contact a technician. Verify Inlet Gas Pressure is within recommended ranges, check regulator settings if supplied, adjust accordingly
	Dirty thermosensor	Clean thermosensor / Follow General Care and Maintenance Procedure
	Misaligned thermosensor	Align the thermosensor
	Thermosensor loose or disconnected	Secure the connection between the thermosensor and the gas valve / Contact gas fitter to establish connections
	Clogged or Dirty Burner Nozzles	Clean nozzles and check for obstruction
Main burner lights but drops out intermittently	Inlet gas pressure too low	Verify Inlet Gas Pressure is within recommended ranges, check regulator settings if supplied, adjust accordingly
	Small / weak pilot flame	Clean Pilot Assembly / Follow General Care and Maintenance Procedure Contact a technician. Verify Inlet Gas Pressure is within recommended ranges, check regulator settings if supplied, adjust accordingly.
	Dirty thermosensor	Clean thermosensor / Follow General Care and Maintenance Procedure
	Misaligned thermosensor	Align the thermosensor
	Thermosensor loose	Secure the connection between the thermosensor and the gas valve
	Strong Wind	Install a glass shield / Make sure that the condition is appropriate for use

WARRANTY INFORMATION

Solus warrants that each Solus Fire Pits conforms to CSA, ANSI, CE and UKCA standards for *Outdoor Decorative Gas Appliance*. All concrete products are professionally inspected and passed Solus' above industry quality standard, and each and every gas burner burned and fire tested prior to leaving the Solus facility in Vancouver.

This warranty is voided if the fire pit is not installed by a licensed technician and if not maintained and operated according to the installation and user's manual. This warranty is also voided if product is modified, altered and tampered with and if a third-party parts and components were used during repair and maintenance.

Warranties are limited to the original purchaser only.

Upon Receipt of the Crate

Solus spares no expense on packaging these fire pits. These products are crated and packed to museum quality standards. However, things can happen along the way. The purchaser, upon receipt of the crate, must visually inspect the crate for damages. Report any crate damages to Solus within 24 hours. Additionally, the content of the crate must be visually inspected within 48 hours. Report to Solus immediately. Solus is not responsible to any damages not reported beyond the specified timelines

Parts Only Limited Warranty

Solus will, at its election, repair or replace the part or product where Solus inspection discloses any such defect occurring with normal usage. Solus will replace all warranted parts free of charge. Client is responsible for the cost of shipping, duties and custom charges when applicable as well as the service and labour cost, re-installation and disposal of the replaced parts and components.

Solus does not provide onsite repair, visits or service.

This warranty does not cover damages to parts and products caused by inappropriate or improper installation, unauthorized modifications to the burner, vessel and parts, and improper maintenance such as failure to put the all-weather cover or metal top when fire pit is not in use.

Concrete Vessels Limited Warranty

Solus concrete products weather and tarnish through exposure to natural elements over time. This naturally occurring process is called Patina.

It is a very rare occasion that a vessel will fracture. Solus will replace cracked and broken concrete vessels resulting from structural defects. Client is responsible for any costs associated with crating, shipping, handling, re-installation labour or disposal of replaced products or components.

Non-structural hairline and spider web-like cracks, surface air voids, chips, scratches and abrasions or minor dimples will not affect the quality and performance of the fire pit therefore shall not be covered by this Warranty. Damages due to excessive loads, for example: Solus fire tables and bowls are not designed for seating purposes and are also not covered by this Warranty.

Any slight variation from the samples received, surface discoloration, texture changes and stains due to exposure to elements like salts, acids, birds droppings, insects, spilled drinks, greasy food and other harmful liquids also is not covered by this Warranty.

General Exclusions

This Warranty also excludes damages to the fire pit occurring due to accident, fire exposure, damages caused by wind and flooding, vandalism, ground movement, neglect, misuse and

Warranty Summary

Type	Components	No cover or metal tabletop purchased	Solus All-Weather cover and/or metal tabletop purchased
Electronic Ignition Fire Features	Brass Burner and brass fittings	5 years	25 years
	Concrete Vessels	1 year	5 years
	Dual Solenoid Valve	1 year	3 years
	Intermittent Pilot Assembly	1 year	3 years
	Sensor Assembly	1 year	3 years
	Ignition Control	1 year	3 years

PARTS LIST

Parts Number	Parts Description
P02085	3" Key
P02185	Ball Valve
P01985	Ball Valve & Flange
P02180	1/2" Yellow Flex Line (36")
P02182	1/2" Yellow Flex Line (26")
P01814	Propane Kit:Gas Regulator with 15' hose
P01990	Burner Nozzles (LP 10K)
P01995	Burner Manifold (LP) 60,000 BTU - 4 NZ crossfire
P01999	Burner Manifold (LP) 73,500 BTU - 5 NZ crossfire
P01966	Burner Manifold (LP) 108,000 BTU - 12 NZ crossfire
A01816	LP to NG / MLS Conversion Kit (includes P02002)
A01818	NG to LP / MLS Conversion Kit
A01820	Pilot Cage
P02011	Universal Pilot with Inlet - LP
P02004	1/4" Pilot Tubing
P02003	LP Inlet Orifice (4212)
P01999	Inlet Fitting with Compression
P01994	Dual Solenoid Gas Valve
P02000	Intermittent Pilot Assembly (NG)
P02020	Intermittent Pilot Assembly (LP)
P02006	Thermosensor
P01998	Ignition Control
P02017	Transformer
P02007	Spark Wire
P02010	Wiring Harness
P02078	Solus (LP) AUTO Burner Package
P02079	Solus (LP) ADJ AUTO Burner Package
A01819	LP to NG / ELEC Conversion Kit (includes P02002)
P02023	Quick Connect Assembly

ACCESSORIES

All Weather Covers



Metal Table Tops



Hardwood Table Tops



Fire Stones



Glass WindShields



Tank Table



PRODUCT REGISTRATION

Thank you for purchasing a Solus Firepit! To protect your investment, please register your fire pit within 30 days of installation. Please fill in as much detail as possible. As noted in our Limited Product Warranty, professional registration number and gas pressure and input voltage readings are required to engage a warranty claim in the unlikely event that one is necessary.

CONTACT INFORMATION:

Name: _____ Organization/Company: _____

Address: _____

Telephone Number: _____ Email: _____

PRODUCT INFORMATION: (please retain proof-of-purchase)

Order #: _____ Firepit Model: _____ Fuel type: Natural Gas Propane Ethanol

Ignition type: Manual Light Manual Light w/Flame Supervision Valve Automatic (Electronic)

Date purchased: _____ Date of Install: _____

Product purchased: Solus directly Specifier / Contractor Reseller

BURNER SERIAL # _____

Gas Fitter Name: _____

Gas Fitter Registration #: _____

Gas Fitter Signature: _____

Date Signed: _____

Inlet Gas Pressure Reading : _____

Test Completed : Yes ____ / No: ____

Electrician Name: _____

Electrician Registration #: _____

Electrician Signature: _____

Date Signed: _____

Input Voltage Reading: _____

Test Completed : Yes ____ / No: ____

How to submit the completed Product Registration Form?

North America - Return to:

Solus Decor Inc
Building C- 109 Braid St
New Westminster, BC V3L 5H4
Canada

Or scan and email to info@solusdecor.com

Or complete online at: www.solusdecor.com/warranty

UK/EU/Spain - Return to:

Solus Decor Ltd - UK
Horsley Rd, East Horsley,
Cobham, KT11 3JX,
United Kingdom

Or scan and email to info@solusdecor.com

Or complete online at: www.solusdecor.co.uk/warranty