

FLEX 50PN

PENINSULA FIREPLACE



Clean Burning

Fueled by clean burning e-NRG bioethanol

Toughened Safety Screen

Your Flex Fireplace features toughened glass to stabilise the flame in windy conditions and provide an additional layer of safety and comfort. The Integrated windscreen sits flush behind the frame.

Room Divider Application

Peninsula fireplaces feature three open sides - view the flame from the front, back and open side.

Global Compliance

These models comply with existing standards in the USA, Europe, UK and Australia. UL Listed, EN 16647 BSI Certified, ACCC Safety Mandate compliant.

Decorative Side Box

When a decorative box is added, the panel between the standard fire and the decorative box is glass.

Luxurious Finish

Available in a timeless black finish, Flex Fireplaces come with stainless steel burners and black glass charcoal.

Built to Last a Lifetime

Zinc sealed steel construction powder coated with super hi-temp black paint prevents rusting so all fireplaces can be used both indoors or outdoors.

Decorative Steel Log Sets (sold separately)

EcoSmart Fire offers non-combustible logs as an optional, eye-catching accessory for models with the decorative side box. Made from stainless steel with a patina finish, they are available in different finishes.

**Decorative logs must NOT be placed directly over an open flame. They are designed to sit near heat but not over flames.*

Zero Clearance

Self-contained, zero clearance construction allows your Flex fireplace to be framed into wood or metal studs, providing installation freedom and flexibility for builders, architects, interior designers, landscapers and homeowners.

OPTIONAL ACCESSORIES



Decorative Steel Logs

Disclaimer: All product specifications and data are subject to change without notice and believed to be correct at the time of publication. MAD Design Group (MDG), its affiliates, agents, and employees, and all persons acting on its or their behalf (collectively, "MAD Design Group"), disclaim any and all liability for any errors, inaccuracies or incompleteness contained herein or in any other disclosure relating to any product. MDG disclaims any and all liability arising out of the use or application of any product described herein or of any information provided herein to the maximum extent permitted by law. The product specifications do not expand or otherwise modify MDG's terms and conditions of purchase, including but not limited to the warranty expressed therein, which apply to these products. No license, express or implied, by estoppel or otherwise, to any intellectual property rights is granted by this document or by any conduct of MDG. Customers using or selling MDG products not expressly indicated for use in such applications do so entirely at their own risk and agree to fully indemnify MDG for any damages arising or resulting from such use or sale. Please contact authorised personnel from MDG to obtain written terms and conditions regarding products designed for such applications. Images are indicative only.

PENINSULA FIREPLACES

Application	Indoor & Outdoor
Materials	Mild Steel (Zinc Sealed), Toughened Glass, Stainless Steel & Black Glass Charcoal as Decorative Media
Colours	Black Firebox, Stainless Steel Burner/s
Fuel Type	e-NRG Bioethanol

FLEX50

ESF.1.FX.50PN

Weight	59.1kg [130lbs] (incl. burner/s, glass charcoal, glass)
Burner	XL900 x 1
Volume Capacity	9 Litres [2.4 Gallons]
Heats on Average (when used indoors)	Over 60 square metres [645 square feet]
Burn Time	8 - 13 hours (approx)
Minimum Room Size	110 cubic metres [3884 cubic feet] per fireplace.
Minimum Wall Length	1,475mm [58in]

ESF.1.FX.50PN.BXL ESF.1.FX.50PN.BXR

Weight	73.2kg [161lbs] (incl. burner/s, glass charcoal, glass)
Burner	XL500 x 1
Volume Capacity	5 Litres [1.3 Gallons]
Heats on Average (when used indoors)	Over 40 square metres [430.6 square feet]
Burn Time	10 - 13 hours (approx)
Minimum Room Size	80 cubic metres [2825 cubic feet] per fireplace.
Minimum Wall Length	1,475mm [58in]

Physical model dimensions should be verified against cut out dimensions BEFORE installation begins to confirm tolerances align.

These values are indicative only and may vary depending on the model purchased, installation, and the seasonal resource used to manufacture e-NRG.

All models can be rotated

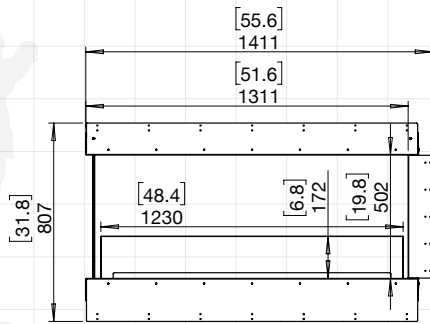

50PN (FLAME ONLY)

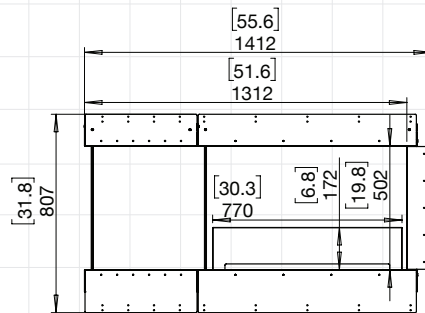

50PN.BXL (LEFT DECORATIVE BOX)

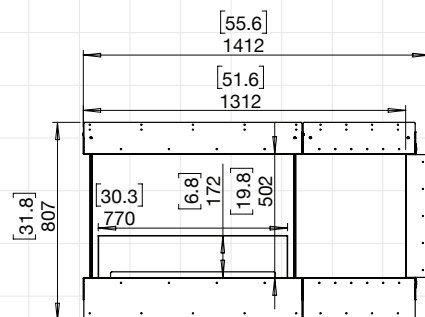

50PN.BXR (RIGHT DECORATIVE BOX)

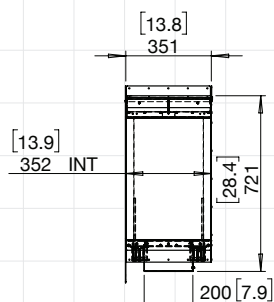

SIDE VIEW

FOR MORE INFORMATION PLEASE REFERENCE THE CLEARANCE & INSTALLATION MANUAL

Disclaimer: All product specifications and data are subject to change without notice and believed to be correct at the time of publication. MAD Design Group (MDG), its affiliates, agents, and employees, and all persons acting on its or their behalf (collectively, "MAD Design Group"), disclaim any and all liability for any errors, inaccuracies or incompleteness contained herein or in any other disclosure relating to any product. MDG disclaims any and all liability arising out of the use or application of any product described herein or of any information provided herein to the maximum extent permitted by law. The product specifications do not expand or otherwise modify MDG's terms and conditions of purchase, including but not limited to the warranty expressed therein, which apply to these products. No license, express or implied, by estoppel or otherwise, to any intellectual property rights is granted by this document or by any conduct of MDG. Customers using or selling MDG products not expressly indicated for use in such applications do so entirely at their own risk and agree to fully indemnify MDG for any damages arising or resulting from such use or sale. Please contact authorised personnel from MDG to obtain written terms and conditions regarding products designed for such applications. Images are indicative only.

**PENINSULA
INSTALLATIONS**



FLEX18PN



FLEX68PN.BXR



FLEX140PN.BX2

FLEX 60PN

PENINSULA FIREPLACE



PENINSULA FIREPLACES

Application	Indoor & Outdoor
Materials	Mild Steel (Zinc Sealed), Toughened Glass, Stainless Steel & Black Glass Charcoal as Decorative Media
Colours	Black Firebox, Stainless Steel Burner/s
Fuel Type	e-NRG Bioethanol

FLEX60

ESF.1.FX.60PN.BXL
ESF.1.FX.60PN.BXR

Weight	87.5kg [192.5lbs] (Incl. burner/s, glass charcoal, glass)
Burner	XL700 x 1
Volume Capacity	7 Litres [1.8 Gallons]
Heats on Average (when used indoors)	Over 50 square metres [538 square feet]
Burn Time	9 - 12 hours (approx)
Minimum Room Size	90 cubic metres [3178 cubic feet] per fireplace.
Minimum Wall Length	1,730mm [68in]

Physical model dimensions should be verified against cut out dimensions BEFORE installation begins to confirm tolerances align.

These values are indicative only and may vary depending on the model purchased, installation, and the seasonal resource used to manufacture e-NRG.

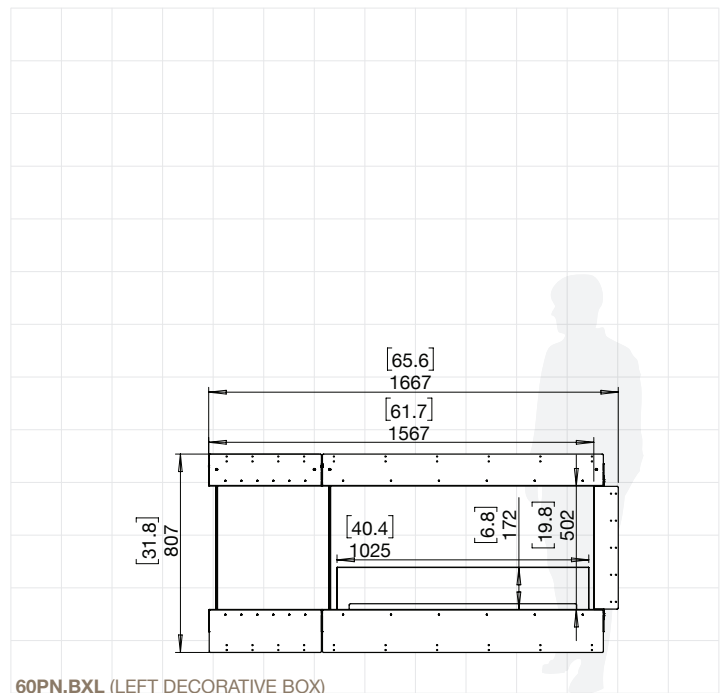

60PN.BXL (LEFT DECORATIVE BOX)

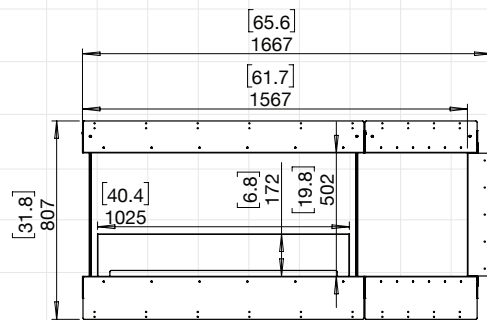

60PN.BXR (RIGHT DECORATIVE BOX)

All models can be rotated

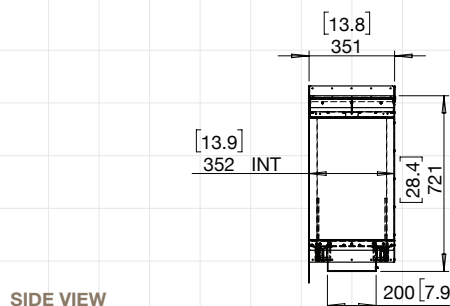

SIDE VIEW

FOR MORE INFORMATION PLEASE REFERENCE THE CLEARANCE & INSTALLATION MANUAL

Disclaimer: All product specifications and data are subject to change without notice and believed to be correct at the time of publication. MAD Design Group (MDG), its affiliates, agents, and employees, and all persons acting on its or their behalf (collectively, "MAD Design Group"), disclaim any and all liability for any errors, inaccuracies or incompleteness contained herein or in any other disclosure relating to any product. MDG disclaims any and all liability arising out of the use or application of any product described herein or of any information provided herein to the maximum extent permitted by law. The product specifications do not expand or otherwise modify MDG's terms and conditions of purchase, including but not limited to the warranty expressed therein, which apply to these products. No license, express or implied, by estoppel or otherwise, to any intellectual property rights is granted by this document or by any conduct of MDG. Customers using or selling MDG products not expressly indicated for use in such applications do so entirely at their own risk and agree to fully indemnify MDG for any damages arising or resulting from such use or sale. Please contact authorized personnel from MDG to obtain written terms and conditions regarding products designed for such applications. Images are indicative only.

FLEX 68PN

PENINSULA FIREPLACE



PENINSULA FIREPLACES

Application	Indoor & Outdoor
Materials	Mild Steel (Zinc Sealed), Toughened Glass, Stainless Steel & Black Glass Charcoal as Decorative Media
Colours	Black Firebox, Stainless Steel Burner/s
Fuel Type	e-NRG Bioethanol

FLEX68

ESF.2.FX.68PN

Weight	102.8kg [226.2lbs] (Incl. burner/s, glass charcoal, glass)
Burner	XL1200 x 1
Volume Capacity	10 Litres [2.6 Gallons] x 1
Heats on Average	Over 65 square metres [700 square feet]
Burn Time	9 - 14 hours (approx)
Minimum Room Size	115 cubic metres [4061 cubic feet] per fireplace
Minimum Wall Length	1,935mm [76in]

ESF.1.FX.68PN.BX2

Weight	96.1kg [211.4lbs] (Incl. burner/s, glass charcoal, glass)
Burner	XL500 x 1
Volume Capacity	5 Litres [1.3 Gallons]
Heats on Average	Over 40 square metres [430.6 square feet]
Burn Time	10 - 13 hours (approx)
Minimum Room Size	80 cubic metres [2825 cubic feet] per fireplace.
Minimum Wall Length	1,935mm [76in]

ESF.1.FX.68PN.BXL ESF.1.FX.68PN.BXR

Weight	83.9kg [184.6lbs] (Incl. burner/s, glass charcoal, glass)
Burner	XL900 x 1
Volume Capacity	9 Litres [2.4 Gallons]
Heats on Average	Over 60 square metres [645 square feet]
Burn Time	8 - 13 hours (approx)
Minimum Room Size	110 cubic metres [3884 cubic feet] per fireplace.
Minimum Wall Length	1,935mm [76in]

Physical model dimensions should be verified against cut out dimensions BEFORE installation begins to confirm tolerances align.

These values are indicative only and may vary depending on the model purchased, installation, and the seasonal resource used to manufacture e-NRG.

All models can be rotated

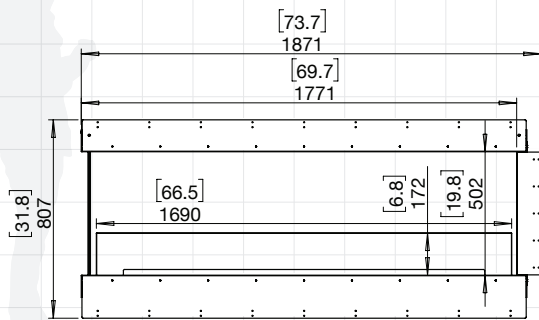

68PN (FLAME ONLY)

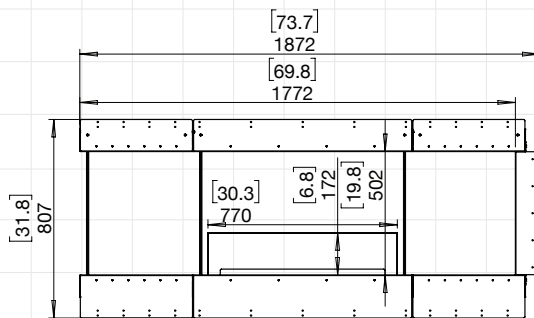

68PN.BX2 (LEFT & RIGHT DECORATIVE BOXES)

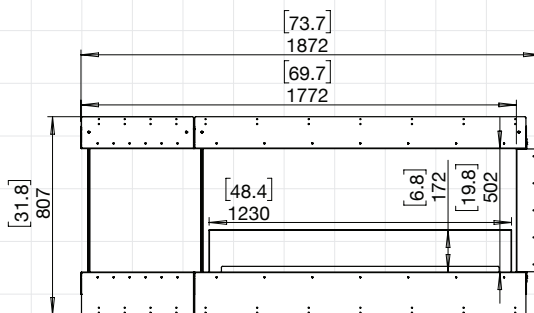

68PN.BXL (LEFT DECORATIVE BOX AS ILLUSTRATED)
68PN.BXR (RIGHT DECORATIVE BOX)

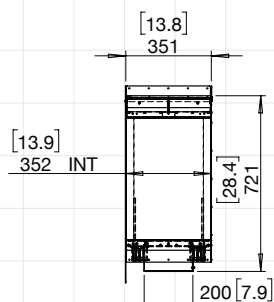

SIDE VIEW

FOR MORE INFORMATION PLEASE REFERENCE THE CLEARANCE & INSTALLATION MANUAL

Disclaimer: All product specifications and data are subject to change without notice and believed to be correct at the time of publication. MAD Design Group (MDG), its affiliates, agents, and employees, and all persons acting on its or their behalf (collectively, "MAD Design Group"), disclaim any and all liability for any errors, inaccuracies or incompleteness contained herein or in any other disclosure relating to any product. MDG disclaims any and all liability arising out of the use or application of any product described herein or of any information provided herein to the maximum extent permitted by law. The product specifications do not expand or otherwise modify MDG's terms and conditions of purchase, including but not limited to the warranty expressed therein, which apply to these products. No license, express or implied, by estoppel or otherwise, to any intellectual property rights is granted by this document or by any conduct of MDG. Customers using or selling MDG products not expressly indicated for use in such applications do so entirely at their own risk and agree to fully indemnify MDG for any damages arising or resulting from such use or sale. Please contact authorised personnel from MDG to obtain written terms and conditions regarding products designed for such applications. Images are indicative only.

FLEX 78PN

PENINSULA FIREPLACE



PENINSULA FIREPLACES

Application	Indoor & Outdoor
Materials	Mild Steel (Zinc Sealed), Toughened Glass, Stainless Steel & Black Glass Charcoal as Decorative Media
Colours	Black Firebox, Stainless Steel Burner/s
Fuel Type	e-NRG Bioethanol

FLEX78

ESF.1.FX.78PN.BX2

Weight	110.4kg [242.9lbs] (Incl. burner/s, glass charcoal, glass)
Burner	XL700 x 1
Volume Capacity	7 Litres [1.8 Gallons]
Heats on Average (when used indoors)	Over 50 square metres [538 square feet]
Burn Time	9 - 12 hours (approx)
Minimum Room Size	90 cubic metres [3178 cubic feet] per fireplace.
Minimum Wall Length	2,190mm [86in]

Physical model dimensions should be verified against cut out dimensions BEFORE installation begins to confirm tolerances align.

These values are indicative only and may vary depending on the model purchased, installation, and the seasonal resource used to manufacture e-NRG.

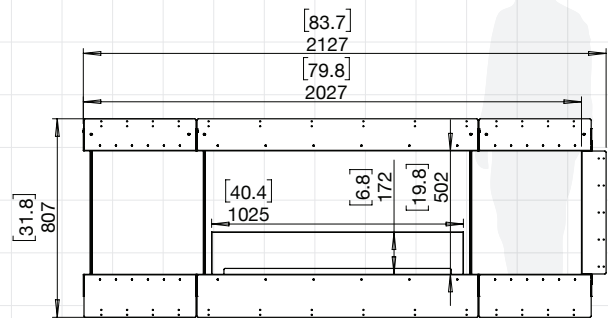

78PN.BX2 (LEFT & RIGHT DECORATIVE BOXES)

Models can be rotated

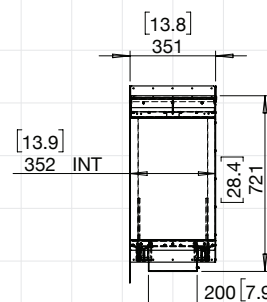

SIDE VIEW

FOR MORE INFORMATION PLEASE REFERENCE THE CLEARANCE & INSTALLATION MANUAL

Disclaimer: All product specifications and data are subject to change without notice and believed to be correct at the time of publication. MAD Design Group (MDG), its affiliates, agents, and employees, and all persons acting on its or their behalf (collectively, "MAD Design Group"), disclaim any and all liability for any errors, inaccuracies or incompleteness contained herein or in any other disclosure relating to any product. MDG disclaims any and all liability arising out of the use or application of any product described herein or of any information provided herein to the maximum extent permitted by law. The product specifications do not expand or otherwise modify MDG's terms and conditions of purchase, including but not limited to the warranty expressed therein, which apply to these products. No license, express or implied, by estoppel or otherwise, to any intellectual property rights is granted by this document or by any conduct of MDG. Customers using or selling MDG products not expressly indicated for use in such applications do so entirely at their own risk and agree to fully indemnify MDG for any damages arising or resulting from such use or sale. Please contact authorized personnel from MDG to obtain written terms and conditions regarding products designed for such applications. Images are indicative only.

FLEX 86PN

PENINSULA FIREPLACE

*Image indicative of style only



PENINSULA FIREPLACES

Application	Indoor & Outdoor
Materials	Mild Steel (Zinc Sealed), Toughened Glass, Stainless Steel & Black Glass Charcoal as Decorative Media
Colours	Black Firebox, Stainless Steel Burner/s
Fuel Type	e-NRG Bioethanol

FLEX86

ESF.1.FX.86PN

Weight	102.5kg [225.5lbs] (Incl. burner/s, glass charcoal, glass)
Burner	XL900 x 2
Volume Capacity	9 Litres [2.4 Gallons] x 2
Heats on Average	Over 120 square metres [1290 square feet]
Burn Time	8 - 13 hours (approx)
Minimum Room Size	220 cubic metres [7768 cubic feet] per fireplace
Minimum Wall Length	2,395mm [94in]

ESF.1.FX.86PN.BX2

Weight	108.7kg [239.1lbs] (Incl. burner/s, glass charcoal, glass)
Burner	XL900 x 1
Volume Capacity	9 Litres [2.4 Gallons]
Heats on Average	Over 60 square metres [645 square feet]
Burn Time	8 - 13 hours (approx)
Minimum Room Size	110 cubic metres [3884 cubic feet] per fireplace
Minimum Wall Length	2,395mm [94in]

ESF.2.FX.86PN.BXL ESF.2.FX.86PN.BXR

Weight	124.1kg [273lbs] (Incl. burner/s, glass charcoal, glass)
Burner	XL1200 x 1
Volume Capacity	10 Litres [2.6 Gallons] x 1
Heats on Average	Over 65 square metres [700 square feet]
Burn Time	9 - 14 hours (approx)
Minimum Room Size	115 cubic metres [4061 cubic feet] per fireplace
Minimum Wall Length	2,395mm [94in]

Physical model dimensions should be verified against cut out dimensions BEFORE installation begins to confirm tolerances align.

These values are indicative only and may vary depending on the model purchased, installation, and the seasonal resource used to manufacture e-NRG.

All models can be rotated

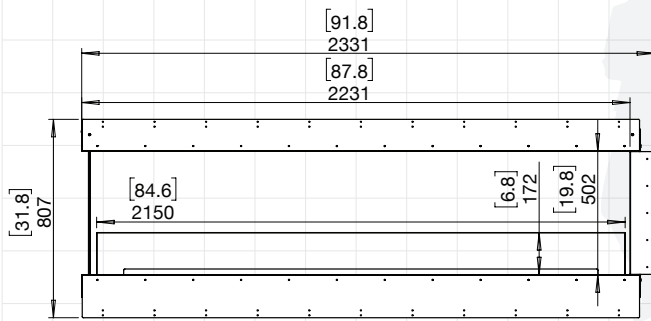

86PN (FLAME ONLY)

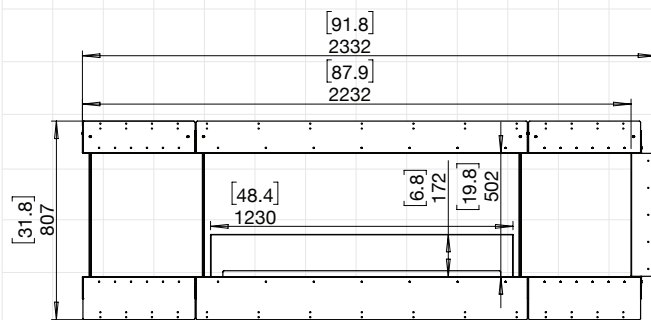

86PN.BX2 (LEFT & RIGHT DECORATIVE BOXES)

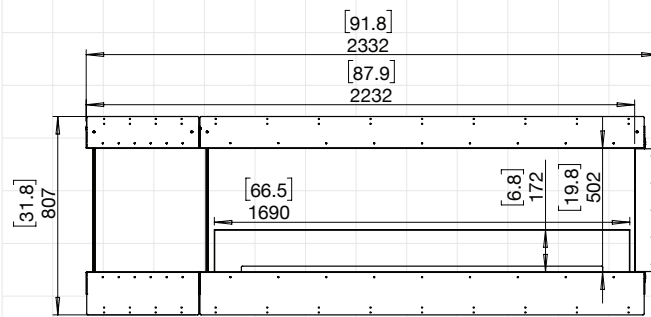

86PN.BXL (LEFT DECORATIVE BOX AS ILLUSTRATED)
86PN.BXR (RIGHT DECORATIVE BOX)

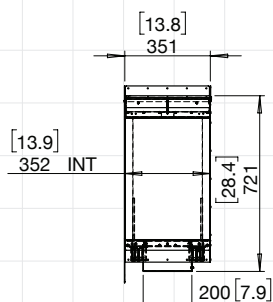

SIDE VIEW

FOR MORE INFORMATION PLEASE REFERENCE THE CLEARANCE & INSTALLATION MANUAL

Disclaimer: All product specifications and data are subject to change without notice and believed to be correct at the time of publication. MAD Design Group (MDG), its affiliates, agents, and employees, and all persons acting on its or their behalf (collectively, "MAD Design Group"), disclaim any and all liability for any errors, inaccuracies or incompleteness contained herein or in any other disclosure relating to any product. MDG disclaims any and all liability arising out of the use or application of any product described herein or of any information provided herein to the maximum extent permitted by law. The product specifications do not expand or otherwise modify MDG's terms and conditions of purchase, including but not limited to the warranty expressed therein, which apply to these products. No license, express or implied, by estoppel or otherwise, to any intellectual property rights is granted by this document or by any conduct of MDG. Customers using or selling MDG products not expressly indicated for use in such applications do so entirely at their own risk and agree to fully indemnify MDG for any damages arising or resulting from such use or sale. Please contact authorised personnel from MDG to obtain written terms and conditions regarding products designed for such applications. Images are indicative only.

FLEX 104PN

PENINSULA FIREPLACE

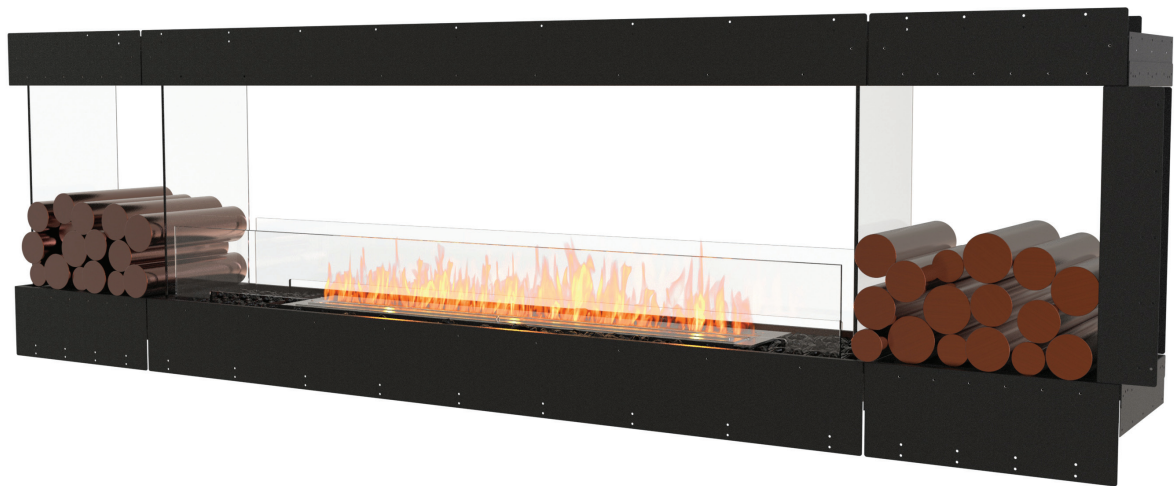

PENINSULA FIREPLACES

Application	Indoor & Outdoor
Materials	Mild Steel (Zinc Sealed), Toughened Glass, Stainless Steel & Black Glass Charcoal as Decorative Media
Colours	Black Firebox, Stainless Steel Burner/s
Fuel Type	e-NRG Bioethanol

FLEX104

ESF.1.FX.104PN

Weight	153.3kg [337.3lbs] (Incl. burner/s, glass charcoal, glass)
Burner	XL1200 x 2
Volume Capacity	10 Litres [2.6 Gallons] x 2
Heats on Average	Over 130 square metres [1400 square feet]
Burn Time	9 - 14 hours (approx)
Minimum Room Size	230 cubic metres [8122 cubic feet] per fireplace
Minimum Wall Length	2,855mm [112in]

ESF.2.FX.104PN.BX2

Weight	147.3kg [324.1lbs] (Incl. burner/s, glass charcoal, glass)
Burner	XL1200 x 1
Volume Capacity	10 Litres [2.6 Gallons] x 1
Heats on Average	Over 65 square metres [700 square feet]
Burn Time	9 - 14 hours (approx)
Minimum Room Size	115 cubic metres [4061 cubic feet] per fireplace
Minimum Wall Length	2,855mm [112in]

ESF.1.FX.104PN.BXL ESF.1.FX.104PN.BXR

Weight	127.3kg [280.1lbs] (Incl. burner/s, glass charcoal, glass)
Burner	XL900 x 2
Volume Capacity	9 Litres [2.4 Gallons] x 2
Heats on Average	Over 120 square metres [1290 square feet]
Burn Time	8 - 13 hours (approx)
Minimum Room Size	220 cubic metres [7768 cubic feet] per fireplace
Minimum Wall Length	2,855mm [112in]

Physical model dimensions should be verified against cut out dimensions BEFORE installation begins to confirm tolerances align.

These values are indicative only and may vary depending on the model purchased, installation, and the seasonal resource used to manufacture e-NRG.

All models can be rotated

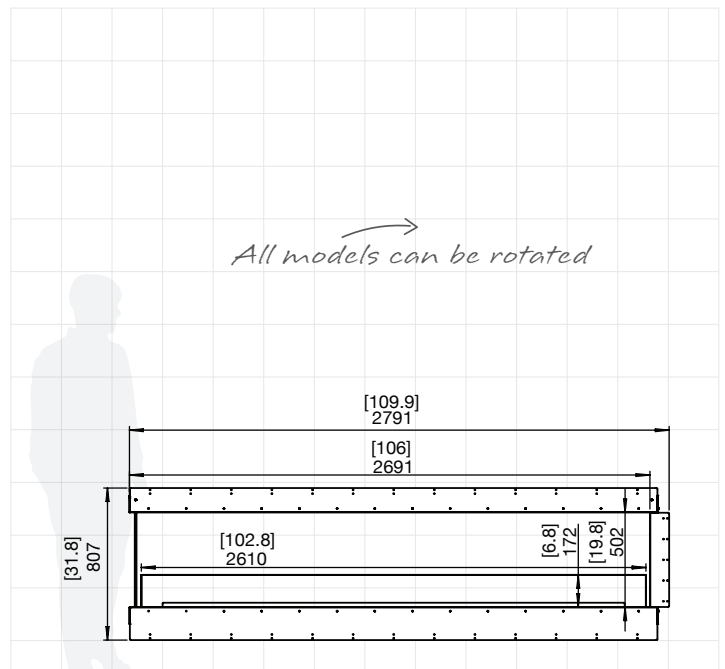

104PN (FLAME ONLY)

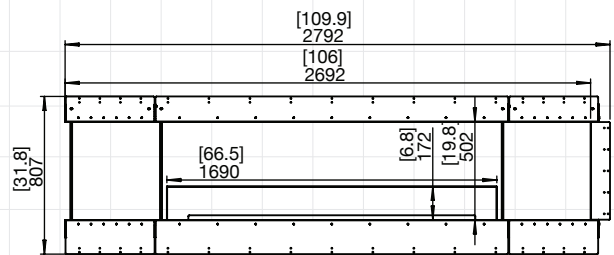

104PN.BX2 (LEFT & RIGHT DECORATIVE BOXES)

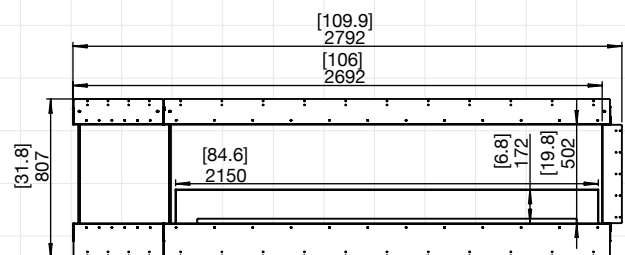

104PN.BXL (LEFT DECORATIVE BOX AS ILLUSTRATED)
104PN.BXR (RIGHT DECORATIVE BOX)

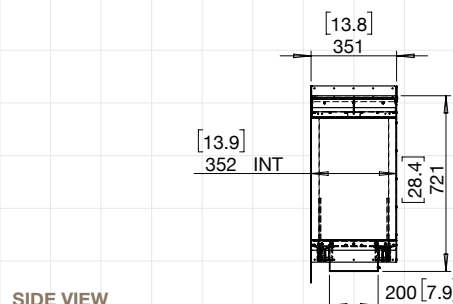

SIDE VIEW

FOR MORE INFORMATION PLEASE REFERENCE THE CLEARANCE & INSTALLATION MANUAL

Disclaimer: All product specifications and data are subject to change without notice and believed to be correct at the time of publication. MAD Design Group (MDG), its affiliates, agents, and employees, and all persons acting on its or their behalf (collectively, "MAD Design Group"), disclaim any and all liability for any errors, inaccuracies or incompleteness contained herein or in any other disclosure relating to any product. MDG disclaims any and all liability arising out of the use or application of any product described herein or of any information provided herein to the maximum extent permitted by law. The product specifications do not expand or otherwise modify MDG's terms and conditions of purchase, including but not limited to the warranty expressed therein, which apply to these products. No license, express or implied, by estoppel or otherwise, to any intellectual property rights is granted by this document or by any conduct of MDG. Customers using or selling MDG products not expressly indicated for use in such applications do so entirely at their own risk and agree to fully indemnify MDG for any damages arising or resulting from such use or sale. Please contact authorized personnel from MDG to obtain written terms and conditions regarding products designed for such applications. Images are indicative only.

FLEX 122PN

PENINSULA FIREPLACE

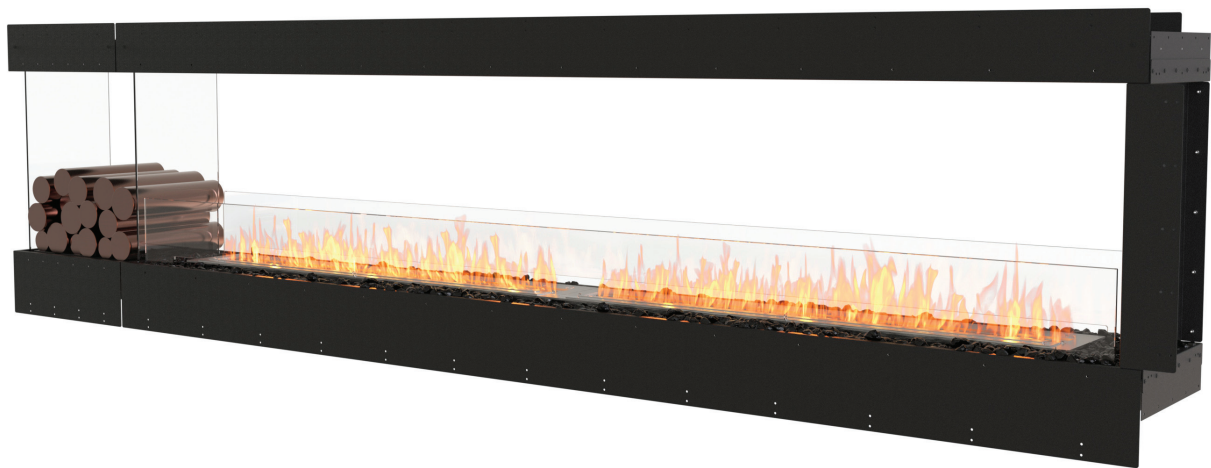

PENINSULA FIREPLACES

Application	Indoor & Outdoor
Materials	Mild Steel (Zinc Sealed), Toughened Glass, Stainless Steel & Black Glass Charcoal as Decorative Media
Colours	Black Firebox, Stainless Steel Burner/s
Fuel Type	e-NRG Bioethanol

FLEX122

ESF.1.FX.122PN

Weight	145.8kg [320.8lbs] (Incl. burner/s, glass charcoal, glass)
Burner	XL900 x 3
Volume Capacity	9 Litres [2.4 Gallons] x 3
Heats on Average	Over 180 square metres [1935 square feet]
Burn Time	8 - 13 hours (approx)
Minimum Room Size	330 cubic metres [11652 cubic feet] per fireplace
Minimum Wall Length	3,315mm [131in]

ESF.1.FX.122PN.BX2

Weight	152.1kg [334.6lbs] (Incl. burner/s, glass charcoal, glass)
Burner	XL900 x 2
Volume Capacity	9 Litres [2.4 Gallons] x 2
Heats on Average	Over 120 square metres [1290 square feet]
Burn Time	8 - 13 hours (approx)
Minimum Room Size	220 cubic metres [7768 cubic feet] per fireplace
Minimum Wall Length	3,315mm [131in]

ESF.1.FX.122PN.BXL

ESF.1.FX.122PN.BXR

Weight	176.2kg [387.6lbs] (Incl. burner/s, glass charcoal, glass)
Burner	XL1200 x 2
Volume Capacity	10 Litres [2.6 Gallons] x 2
Heats on Average	Over 130 square metres [1400 square feet]
Burn Time	9 - 14 hours (approx)
Minimum Room Size	230 cubic metres [8122 cubic feet] per fireplace
Minimum Wall Length	3,315mm [131in]

Physical model dimensions should be verified against cut out dimensions BEFORE installation begins to confirm tolerances align.

These values are indicative only and may vary depending on the model purchased, installation, and the seasonal resource used to manufacture e-NRG.

All models can be rotated

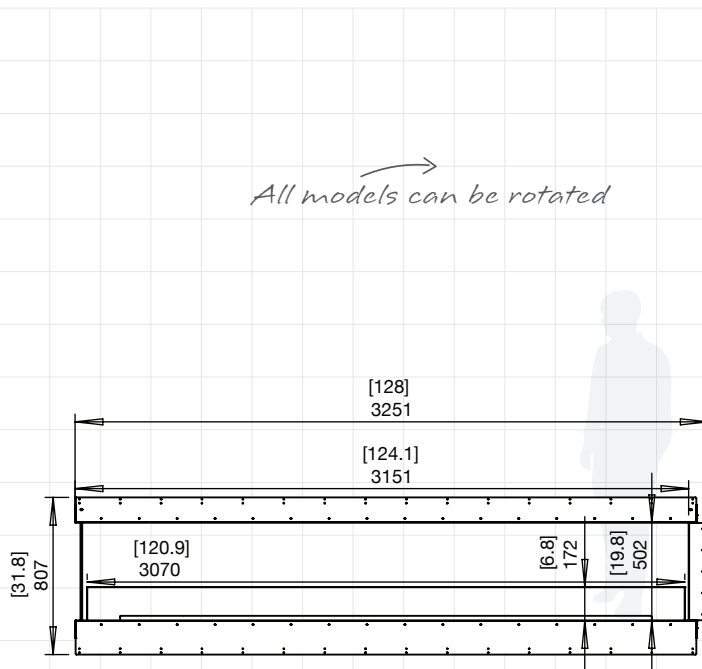

122PN (FLAME ONLY)

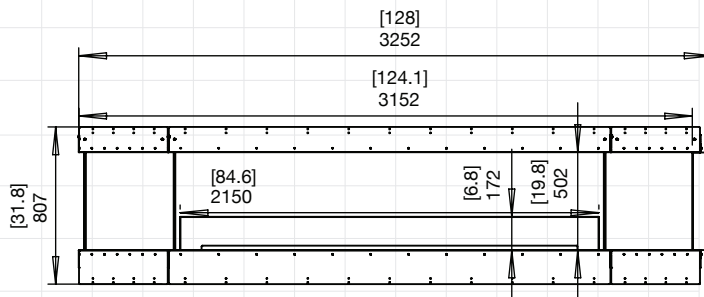

122PN.BX2 (LEFT & RIGHT DECORATIVE BOXES)

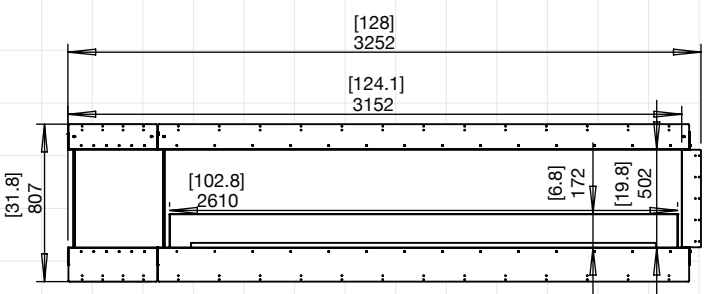

122PN.BXL (LEFT DECORATIVE BOX AS ILLUSTRATED)
122PN.BXR (RIGHT DECORATIVE BOX)

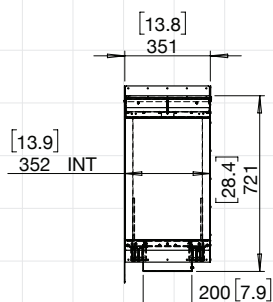

SIDE VIEW

FOR MORE INFORMATION PLEASE REFERENCE THE CLEARANCE & INSTALLATION MANUAL

Disclaimer: All product specifications and data are subject to change without notice and believed to be correct at the time of publication. MAD Design Group (MDG), its affiliates, agents, and employees, and all persons acting on its or their behalf (collectively, "MAD Design Group"), disclaim any and all liability for any errors, inaccuracies or incompleteness contained herein or in any other disclosure relating to any product. MDG disclaims any and all liability arising out of the use or application of any product described herein to the maximum extent permitted by law. The product specifications do not expand or otherwise modify MDG's terms and conditions of purchase, including but not limited to the warranty expressed therein, which apply to these products. No license, express or implied, by estoppel or otherwise, to any intellectual property rights is granted by this document or by any conduct of MDG. Customers using or selling MDG products not expressly indicated for use in such applications do so entirely at their own risk and agree to fully indemnify MDG for any damages arising or resulting from such use or sale. Please contact authorised personnel from MDG to obtain written terms and conditions regarding products designed for such applications. Images are indicative only.

FLEX 140PN

PENINSULA FIREPLACE



Peninsula Fireplaces

Award	2020 BIMsmith Best Award (USA)
Application	Indoor & Outdoor
Materials	Mild Steel (Zinc Sealed), Toughened Glass, Grade 304 Stainless Steel
Colours	Black Firebox, Stainless Steel Burner/s
Fuel Type	e-NRG Bioethanol

FLEX140

ESF.1.FX.140PN.BX2

Weight	198.7kg [437.1lbs] (Incl. burner/s, glass charcoal, glass)
Burner	XL1200 x 2
Volume Capacity	10 Litres [2.6 Gallons] x 2
Heats on Average	Over 130 square metres [1400 square feet]
Burn Time	9 - 14 hours (approx)
Minimum Room Size	230 cubic metres [8122 cubic feet] per fireplace
Minimum Wall Length	3,775mm [149in]

ESF.1.FX.140PN.BXL ESF.1.FX.140PN.BXR

Weight	170.6kg [375.3lbs] (Incl. burner/s, glass charcoal, glass)
Burner	XL900 x 3
Volume Capacity	9 Litres [2.4 Gallons] x 3
Heats on Average	Over 180 square metres [1935 square feet]
Burn Time	8 - 13 hours (approx)
Minimum Room Size	330 cubic metres [11652 cubic feet] per fireplace
Minimum Wall Length	3,775mm [149in]

Physical model dimensions should be verified against cut out dimensions BEFORE installation begins to confirm tolerances align.

These values are indicative only and may vary depending on the model purchased, installation, and the seasonal resource used to manufacture e-NRG.

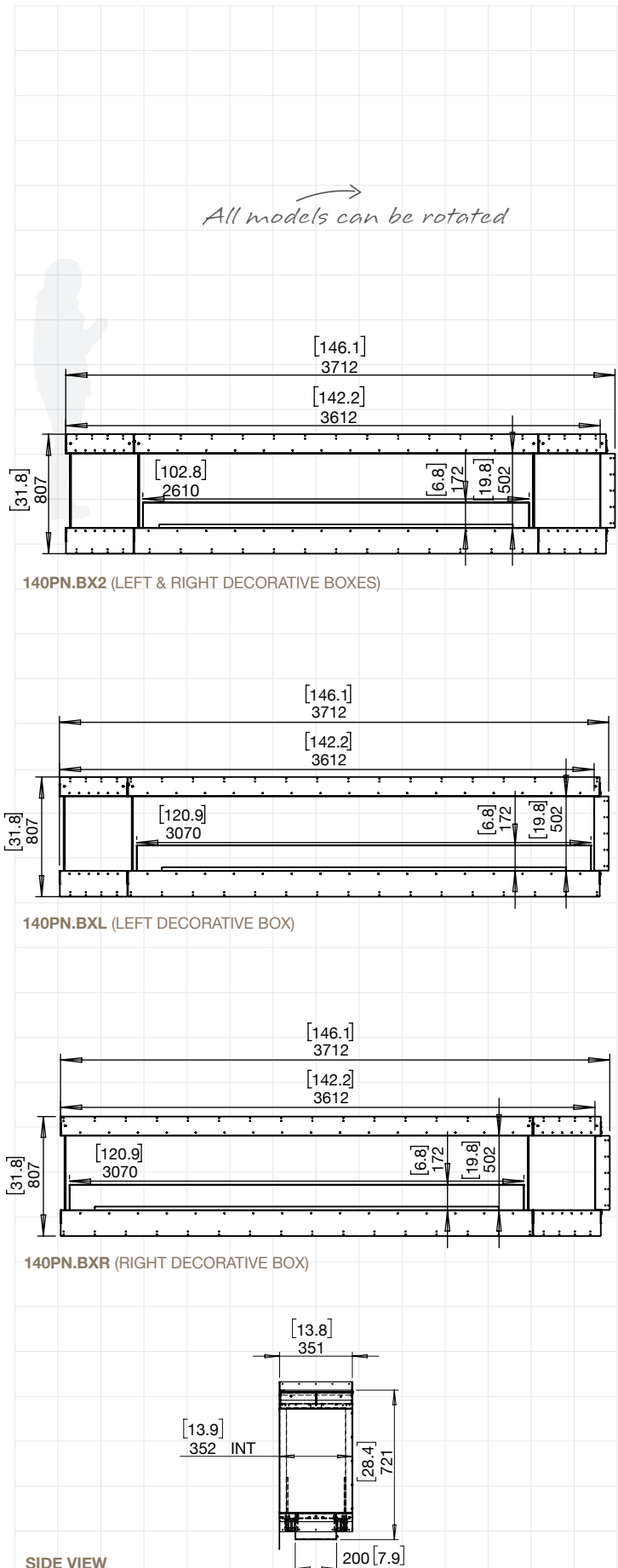

FOR MORE INFORMATION PLEASE REFERENCE THE CLEARANCE & INSTALLATION MANUAL

Disclaimer: All product specifications and data are subject to change without notice and believed to be correct at the time of publication. MAD Design Group (MDG), its affiliates, agents, and employees, and all persons acting on its or their behalf (collectively, "MAD Design Group"), disclaim any and all liability for any errors, inaccuracies or incompleteness contained herein or in any other disclosure relating to any product. MDG disclaims any and all liability arising out of the use or application of any product described herein or of any information provided herein to the maximum extent permitted by law. The product specifications do not expand or otherwise modify MDG's terms and conditions of purchase, including but not limited to the warranty expressed therein, which apply to these products. No license, express or implied, by estoppel or otherwise, to any intellectual property rights is granted by this document or by any conduct of MDG. Customers using or selling MDG products not expressly indicated for use in such applications do so entirely at their own risk and agree to fully indemnify MDG for any damages arising or resulting from such use or sale. Please contact authorised personnel from MDG to obtain written terms and conditions regarding products designed for such applications. Images are indicative only.

FLEX 158PN

PENINSULA FIREPLACE

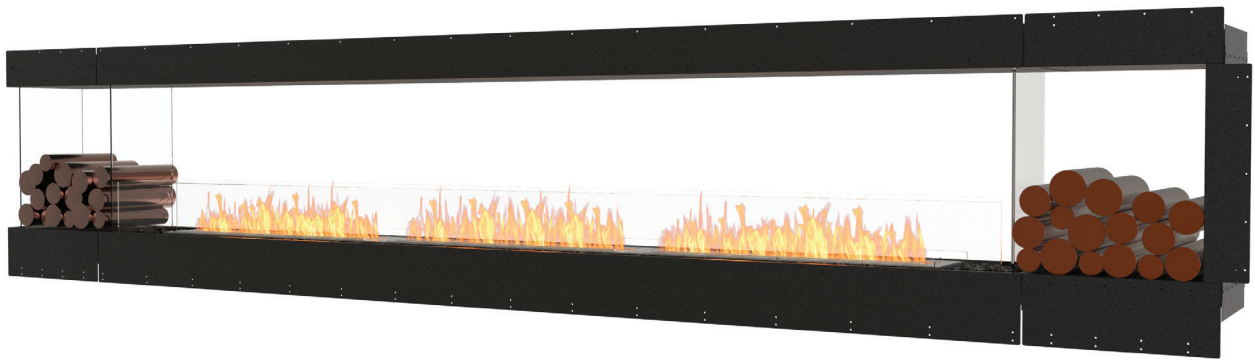

Peninsula Fireplaces

Award	2020 BIMsmith Best Award (USA)
Application	Indoor & Outdoor
Materials	Mild Steel (Zinc Sealed), Toughened Glass, Grade 304 Stainless Steel
Colours	Black Firebox, Stainless Steel Burner/s
Fuel Type	e-NRG Bioethanol

FLEX158

ESF.1.FX.158PN

Weight	231.8kg [510lbs] (Incl. burner/s, glass charcoal, glass)
Burner	XL1200 x 3
Volume Capacity	10 Litres [2.6 Gallons] x 3
Heats on Average	Over 195 square metres [2100 square feet]
Burn Time	9 - 14 hours (approx)
Minimum Room Size	345 cubic metres [12183 cubic feet] per fireplace
Minimum Wall Length	4,235mm [167in]

ESF.1.FX.158PN.BX2

Weight	195.4kg [429.9lbs] (Incl. burner/s, glass charcoal, glass)
Burner	XL900 x 3
Volume Capacity	9 Litres [2.4 Gallons] x 3
Heats on Average	Over 180 square metres [1935 square feet]
Burn Time	8 - 13 hours (approx)
Minimum Room Size	330 cubic metres [11652 cubic feet] per fireplace
Minimum Wall Length	4,235mm [167in]

Physical model dimensions should be verified against cut out dimensions BEFORE installation begins to confirm tolerances align.

These values are indicative only and may vary depending on the model purchased, installation, and the seasonal resource used to manufacture e-NRG.

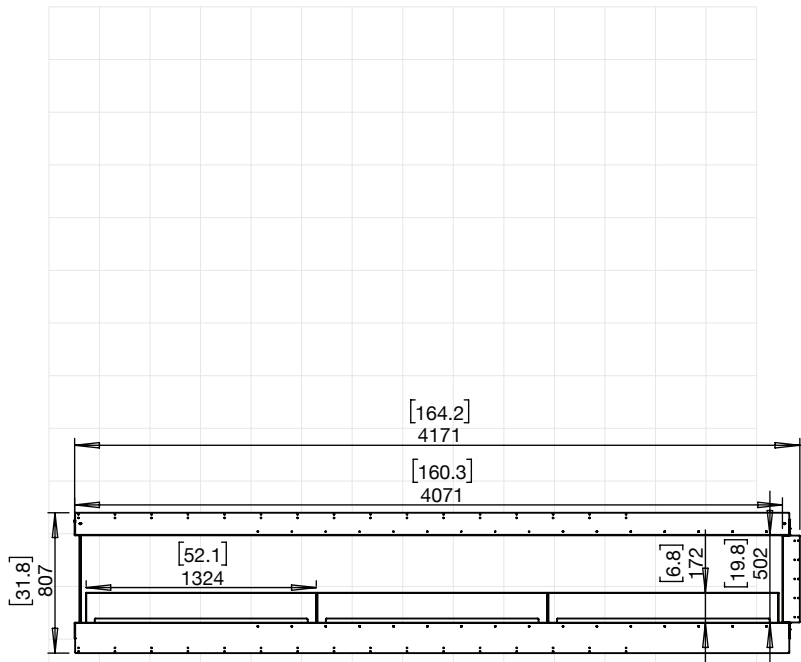

158PN (FLAME ONLY)

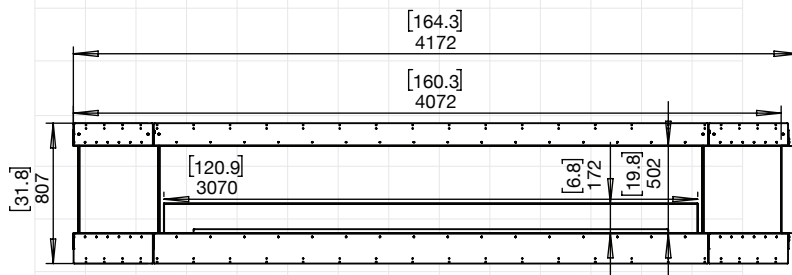

158PN.BX2 (LEFT & RIGHT DECORATIVE BOXES)

All models can be rotated

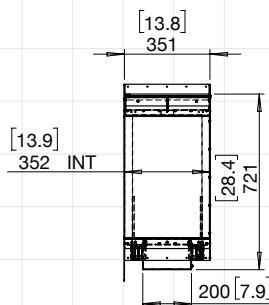

SIDE VIEW

FOR MORE INFORMATION PLEASE REFERENCE THE CLEARANCE & INSTALLATION MANUAL

Disclaimer. All product specifications and data are subject to change without notice and believed to be correct at the time of publication. MAD Design Group (MDG), its affiliates, agents, and employees, and all persons acting on its or their behalf (collectively, "MAD Design Group"), disclaim any and all liability for any errors, inaccuracies or incompleteness contained herein or in any other disclosure relating to any product. MDG disclaims any and all liability arising out of the use or application of any product described herein or of any information provided herein to the maximum extent permitted by law. The product specifications do not expand or otherwise modify MDG's terms and conditions of purchase, including but not limited to the warranty expressed therein, which apply to these products. No license, express or implied, by estoppel or otherwise, to any intellectual property rights is granted by this document or by any conduct of MDG. Customers using or selling MDG products not expressly indicated for use in such applications do so entirely at their own risk and agree to fully indemnify MDG for any damages arising or resulting from such use or sale. Please contact authorised personnel from MDG to obtain written terms and conditions regarding products designed for such applications. Images are indicative only.