



MIMOSA CITY TRAVELLER INFANT CAR SEAT User Manual



Singapore Importer/Distributor:
Kim Hin Innovation Labs Private Ltd
601 Sims Drive, Pan-I Complex,
Singapore 387382
Email: kil.cs@khi.global

Hong Kong Importer/Distributor:
Trade Solutions Ltd
Unit D, 13A/F, Gemstar Tower,
23 Man Lok Street, Hunghom,
Kowloon, Hong Kong
Email: sales@khi.global

Malaysia Importer/Distributor:
Global Retail Network Sdn Bhd
201001037475 (921399-V)
Wisma Pang Cheng Yean, Lot 5205C,
Jalan Perindustrian Balakong Jaya 1/3,
Kawasan Perindustrian Balakong Jaya,
43300 Seri Kembangan,
Selangor Darul Ehsan, Malaysia
Email: sales.support@khi.global

MMS17061

<https://mimosa-online.com>



	28lbs
	13kg

This infant car seat is suitable from birth to 12 months and the maximum load is 13kg. This infant car seat has been designed to comply with ECE R44-04 Standard.

Important – Please read the instruction before assembly.

mimosa

CONTENTS

1. Safety information.....	1
2. Understanding your vehicle.....	3
3. Infant car seat parts.....	5
4. Adjusting the carrying handle.....	6
5. Adjusting the height of the shoulder straps.....	7
6. Adjusting the tightness of the shoulder straps.....	8
7. Securing the harness buckle.....	9
8. Securing the child with harness system.....	10
9. Installing the infant car seat in vehicle.....	11
10. Installing the infant car seat in stroller frame.....	13
11. Removing the canopy and seat cover.....	14
12. Cleaning and maintenance.....	15

1. SAFETY INFORMATION

Please read this user manual carefully before using this product.
Important - Keep these instructions for future reference.

- WARNING This infant car seat should only be installed by an adult. It is suitable for child from 0 to 13kg (approx. from birth to 12 months) and height 66cm or less (i.e. top of child's head is more than 2cm away from the top of the car seat).
- WARNING This infant car seat can only be installed in a rear-facing position using a 3-point vehicle seat belt.
- WARNING Make sure the vehicle seat belt is tight and not twisted.
- WARNING Please follow the installation diagrams on the infant car seat or user manual when installing the infant car seat to your vehicle.
- WARNING The infant car seat should be properly secured so that your child is well protected in the event of an accident.
- WARNING Always make sure the handle is properly locked in the upright carrying position before carrying a child in the infant car seat.
- WARNING Never place the infant car seat on a vehicle seat with an active airbag.

- WARNING Do not leave your child on the infant car seat unattended.
- WARNING Always use the 5-point harness provided and make sure it is correctly fitted. Ensure the harness is not twisted.
- WARNING The harness buckle cannot be in a semi-locked state. Always ensure the infant car seat is secured before using so that in case of emergency, your child can be taken out quickly.
- WARNING Do not put your child at risk by using other replacement covers which could prevent the infant car seat from protecting your child as it should.
- WARNING For your child's safety, do not use a damaged or second-hand infant car seat. This infant car seat should be changed in a timely manner, in the event of a prior accident.
- WARNING Keep the infant car seat away from corrosive fluids.
- WARNING Do not allow the infant car seat to be jammed in the vehicle door, seat runners, etc.
- WARNING Do not install infant car seat on an unlocked foldable vehicle seat as it may lead to the infant car seat losing its effectiveness in an emergency brake situation.
- WARNING Any luggage or other objects liable to cause injuries in the event of collision should be properly secured.
- WARNING Please cover the infant car seat properly when the vehicle is parked under direct sunlight. The parts of the infant car seat that are not provided with a textile cover should be kept away from the sunlight. Prolong exposure may result in the seat heating up, and becoming too hot for your child. Never use the infant car seat without the cover.
- WARNING Do not put any padding under the car seat to increase height because it may cause the infant car seat to lose its effectiveness in the event of an accident. Always keep the infant car seat secure in the vehicle even when it is unoccupied. Do not place heavy objects on it.
- WARNING Do not make any additions or changes to the infant car seat. Do not use other installation methods except for the instructions provided in the user manual.
- WARNING Do not use any load bearing contact points other than those described in the instructions and marked on the infant car seat.
- WARNING Do not use the infant car seat with a shopping cart.
- WARNING The user manual should be retained for the life span of the infant car seat.

2. UNDERSTANDING YOUR VEHICLE

1. This is a "Universal" child restraint. It conforms to ECE R44-04 for general use in vehicles and it will fit most, but not all vehicle seats.
2. A correct fit is possible if the vehicle is capable of accepting a "Universal child restraint" for this age group.
3. If in doubt, please contact the manufacturer, distributor or retailer.

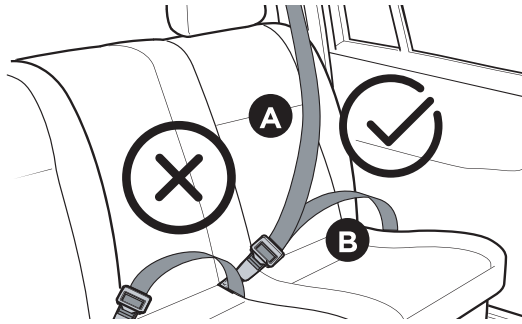

✓ Possible to install ✗ Do not install

⚠WARNING

This infant car seat can only be installed using a 3-point vehicle seat belt.

- Ⓐ Vehicle seat belt: Shoulder Belt
- Ⓑ Vehicle seat belt: Lap Belt

This car seat is suitable for all vehicles equipped with a 3-point seat belt conforming to ECE R15 regulation.

⚠WARNING

This infant car seat can only be installed on a forward-facing back passenger seat. Do not install the infant car seat at the rearward or side-facing passenger seat.

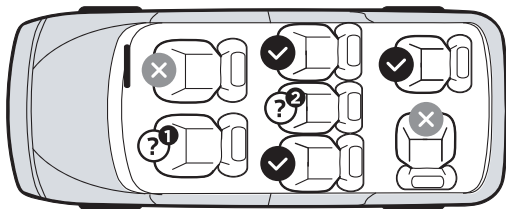

Note: Above illustration is based on a right-hand drive car.

- ❓¹ Do not install the car seat at the front passenger seat with an active airbag.
- ❓² The car seat can be used if this passenger seat has a 3-point seat belt.
- ✓ Suitable for installation of car seat.
- ✗ Do not install car seat at this position.

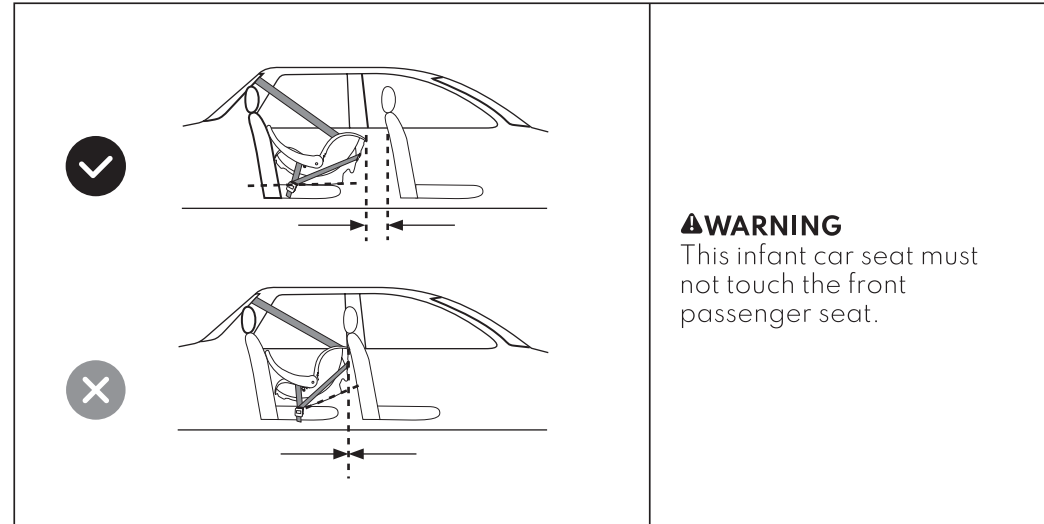

⚠WARNING

This infant car seat must not touch the front passenger seat.

3. INFANT CAR SEAT PARTS

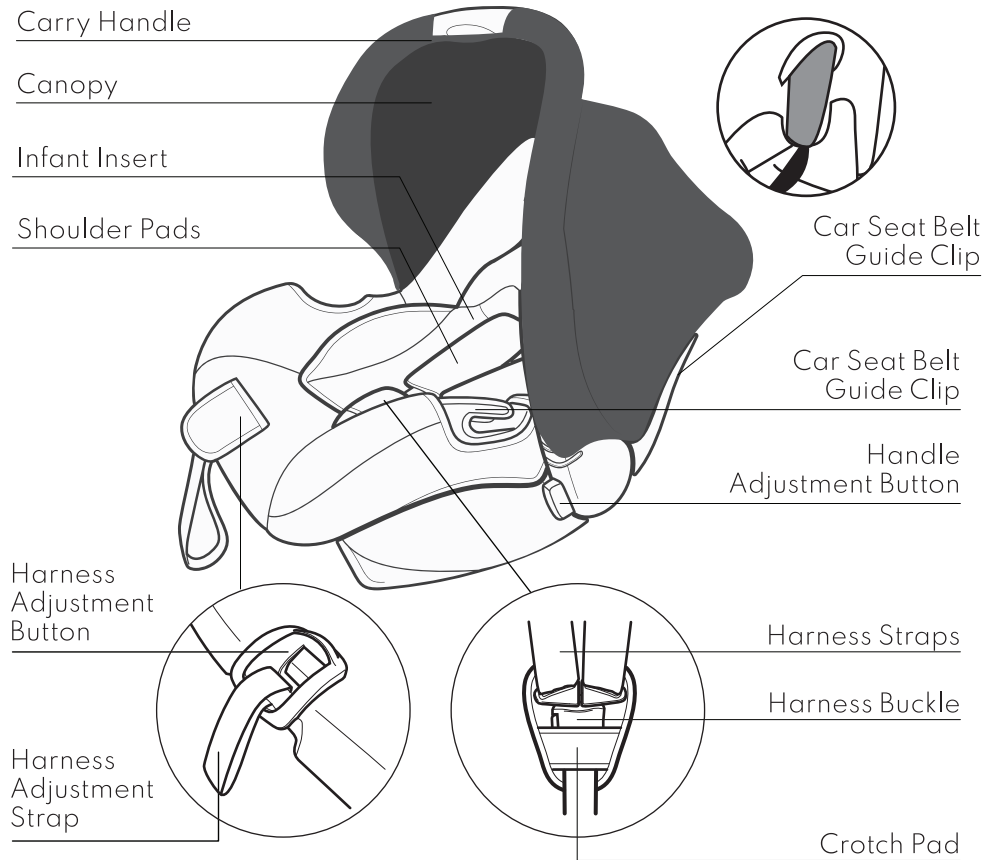

4. ADJUSTING THE CARRY HANDLE

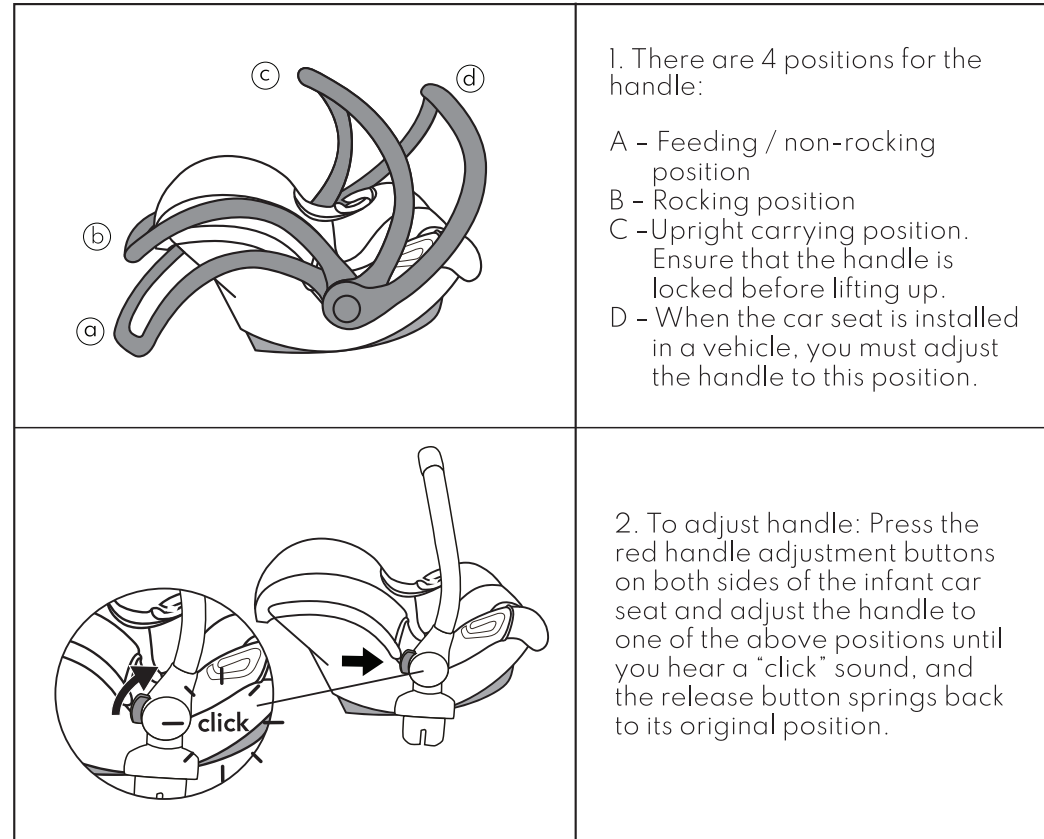

5. ADJUSTING THE HEIGHT OF THE SHOULDER STRAP

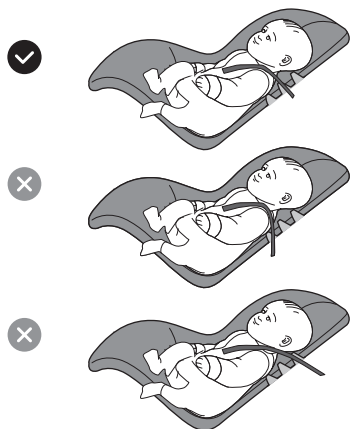

1. Align the shoulder straps to your child's shoulders. The shoulder straps should not be lower or higher than your child's shoulders.

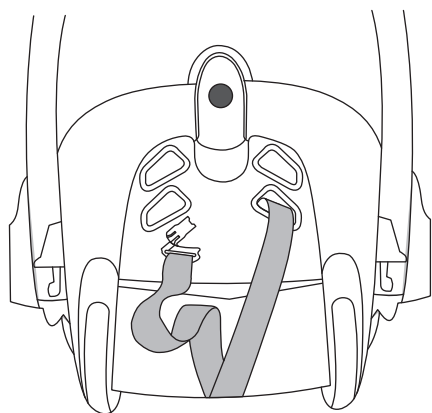

2. To adjust the shoulder straps:

Unfasten the harness system from the harness buckle and remove shoulder pads from shoulder straps.

Pull the shoulder straps out from the back of the infant car seat.

Insert the shoulder straps through the appropriate shoulder strap slot, towards the front of the infant car seat.

Ensure that both shoulder straps are of the same height, and are not twisted.

6. ADJUSTING THE TIGHTNESS OF THE SHOULDER STRAPS

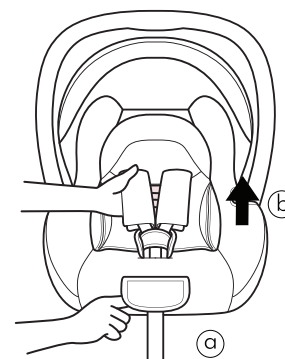

1. To loosen the shoulder straps: Press the harness adjustment button under seat cover (A) and pull the shoulder straps towards yourself (B) until shoulder straps are of desired tightness.

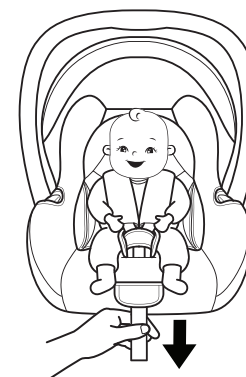

2. To tighten the shoulder straps: Pull the harness adjustment strap until shoulder straps are of desired tightness.

Note: At the ideal tightness, the shoulder strap should allow 1 finger width (1cm) of space at the top of your child's shoulder.

7. SECURING THE HARNESS BUCKLE

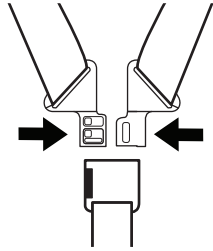

1. Put the left and right tongues of the buckle together, and ensure that they are firmly joined together.

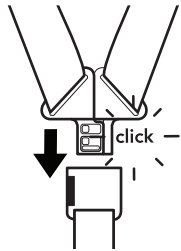

2. Insert the joined buckle tongues into the harness buckle until you hear a "click" sound.

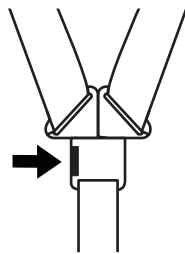

3. To release the harness, press the red release button on the harness buckle.

8. SECURING THE HARNESS SYSTEM

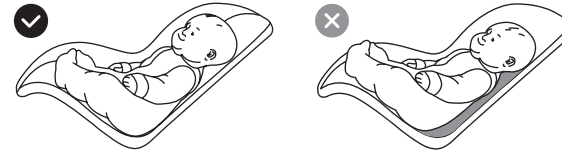

1. Place your child in the infant car seat, ensure that there is no space under the child.



2. Slide the shoulder straps over your child's shoulder, make sure the shoulder straps are aligned with the height of your child's shoulders.

Note: A newborn needs extra support around the head and body. Please ensure that you are using the infant insert with the infant car seat if your child is less than 7 months old and/or less than 9kg.



3. Put the left and right tongues of the buckle together, and ensure that they are firmly joined together. Insert the joined buckle tongues into the harness buckle until you hear a "click" sound.



4. Adjust the tightness of the shoulder straps where necessary, following instructions from Section 8.

Note: At the ideal tightness, the shoulder strap should allow 1 finger width (1cm) of space at the top of your child's shoulder.

9. INSTALLING THE INFANT CAR SEAT IN VEHICLE



1. Place your child in the infant car seat and ensure that the harness system is properly secured.



2. Place the infant car seat rearward-facing on the vehicle seat equipped with a 3-point car seat belt. Ensure that the handle is in the upright position. Your child should face the vehicle seat's backrest.

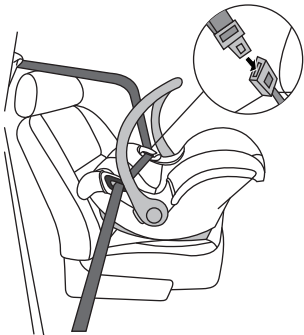

3. Pull out the vehicle seat belt and guide the lap section of the vehicle seat belt through the blue-marked lap belt guide slots on both sides of the infant car seat.

Fasten the vehicle seat belt into the buckle until you hear a "click" sound.

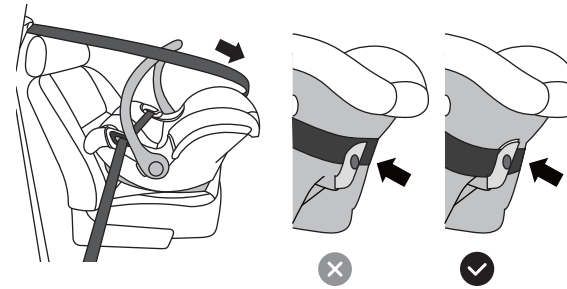

4. Place the vehicle shoulder belt around the back of the infant car seat and secure it onto the blue-marked seat belt guide slot at the back of the infant car seat.

Ensure that the vehicle shoulder belt is entirely secured behind the seat belt guide slot.

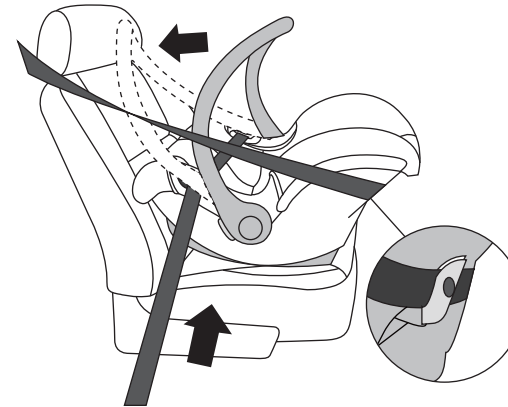

5. Press the handle adjustment buttons on both sides of the car seat and adjust the carrying handle towards the vehicle seat's backrest.

Tighten the vehicle seat belt in the direction of arrows in the diagram.

Double check that the vehicle seat belt is threaded correctly through and underneath the three points marked in bright blue. Ensure that the belts are not twisted.

10. INSTALLING THE INFANT CAR SEAT IN STROLLER

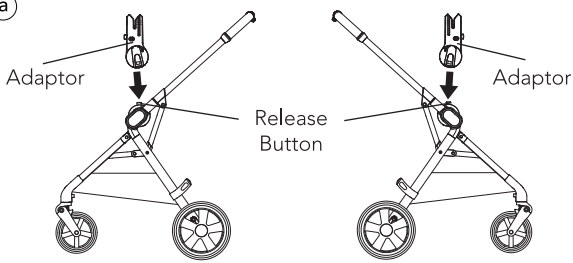
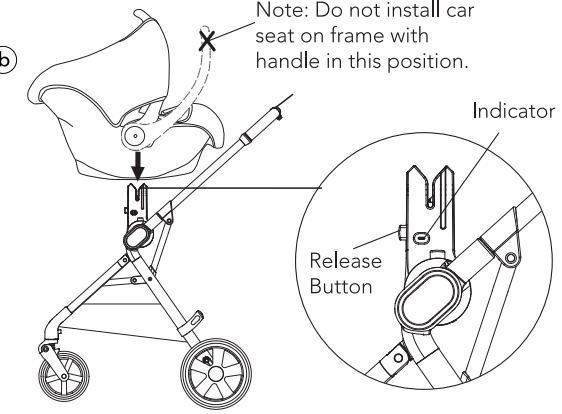
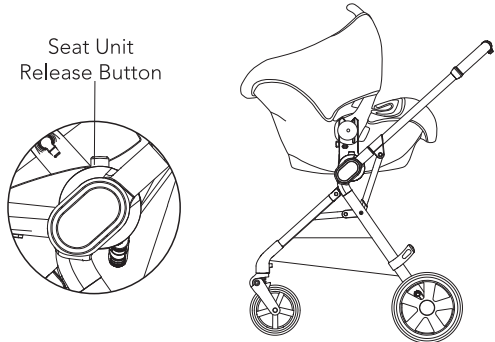
<p>(a)</p>  <p>(b)</p> 	<p>1. To install (A) Remove seat unit from the frame following instructions in Section 9 of the stroller's user manual.</p> <p>Insert the left and right car seat adaptors into the attachment slots on both sides of the stroller frame until you hear a "click" sound. (The release buttons on the adaptors should face the front.)</p> <p>(B) Position the infant car seat in the parent-facing direction and place it on to the adaptors until you hear a "click" sound. The colour indicator on the adaptor should turn green when the car seat is securely fitted.</p> <p>Note: The infant car seat must be installed only in the parent-facing direction. Remove the car seat before folding the stroller. When the car seat is installed on the stroller frame, do not adjust the car seat's handle to the direction shown in (B)</p>
	<p>2. To detach Push the seat unit release buttons on both sides of the stroller downwards. At the same time, lift the car seat perpendicularly upward off the frame.</p>

11. REMOVING THE CANOPY AND SEAT COVER

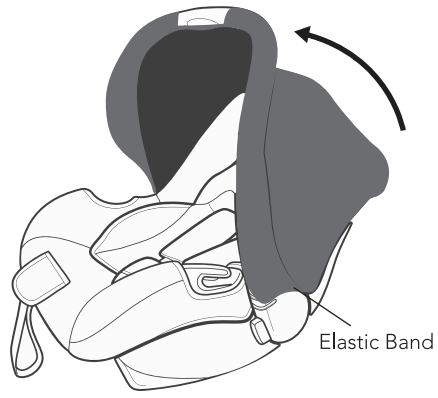
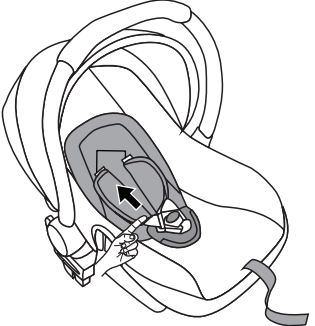
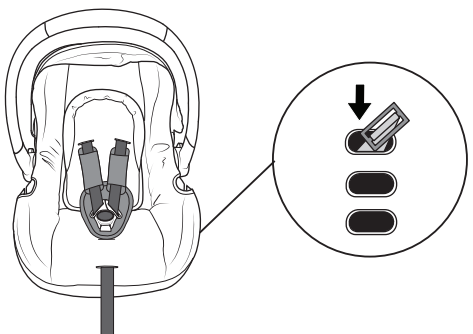
	<p>1. To remove the canopy: Remove the elastic bands on either side of the infant car seat and remove canopy.</p> <p>To re-fit the canopy: With the handle in the upright position, fit the canopy fabric around the top of the infant car seat, then loop the elastic bands on both sides of the infant car seat. Finally, stretch the canopy fabric towards the front and wrap it around the carrying handle.</p>
<p>(a)</p>  <p>(b)</p> 	<p>2. To remove the seat cover:</p> <p>a. Press the red release button on the harness buckle to release the harness system.</p> <p>b. Remove the crotch strap by rotating the metal plate located at the bottom of the infant car seat and pushing it out through the front of the infant car seat.</p> <p>c. Unfasten the elastic loops under the car seat and remove car seat cover from the shell.</p> <p>Note: Reverse above steps to re-fit the covers.</p>

12. CLEANING AND MAINTENANCE

Maintenance Tips

These tips will help you take care of your Mimosa infant car seat.

- Periodically check the infant car seat for damaged or worn parts. Do not use this car seat if any part is damaged or worn.
- The harness system is a safety feature. Please use water to clean the harness buckle as food, drinks and other residues may easily accumulate in the buckle. If the buckle is jammed, please contact the manufacturer or retailer.
- Wipe the harness belts and plastic components with warm water and mild soap.

Cleaning the fabrics

- The infant car seat cover is washable with room temperature water and mild soap.
- You can use a sponge, warm water and mild liquid soap to gently rub off any dirt on the fabric.

