

# POLYMER SEALS

ENGINEERED POLYMER SOLUTIONS  
FOR HYDRAULIC, PNEUMATIC,  
AND ROTATING EQUIPMENT

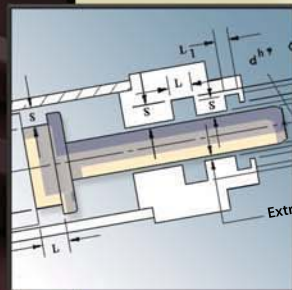

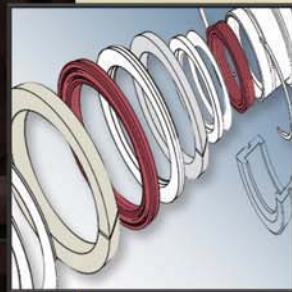
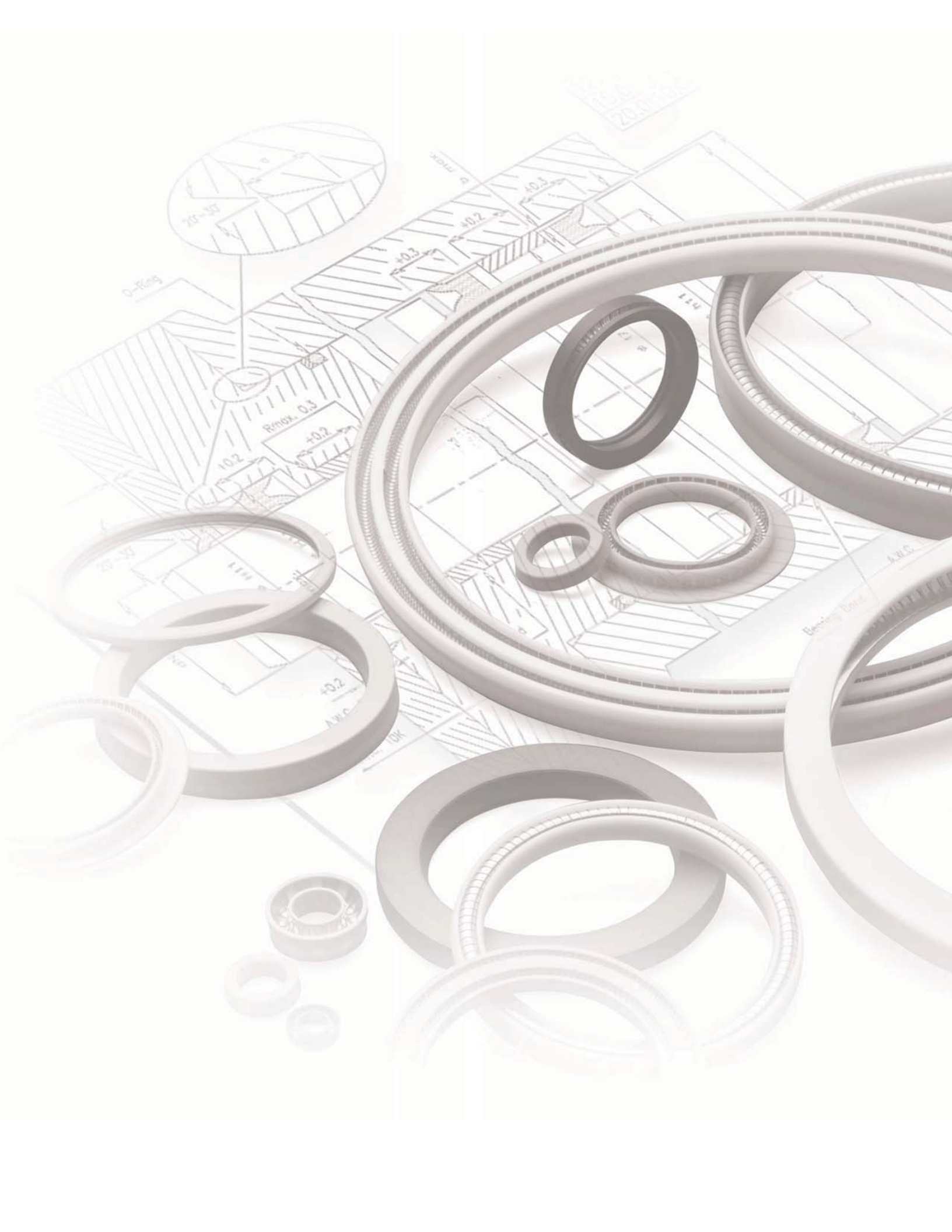

# Table of Contents

## CHESTERTON OVERVIEW

### Introduction

How to Use This Catalog .....	06
Product Guidelines .....	08
Catalog Legend .....	09

## HYDRAULIC AND PNEUMATIC SEALS ..... SECTION I

### Wipers

Standard .....	14
Canned .....	15

### Rod Seals

U-cups .....	16
Stacked Sets .....	21
Compression .....	24
Face and Static .....	27

### Piston Seals

U-cups .....	16
Stacked Sets .....	21
Compression .....	24
Piston Cup .....	26
Face and Static .....	27

### Ancillary Devices

Anti-Extrusion Rings .....	28
Bearing Strips.....	29
Bearing Bands .....	30

## ROTARY AND SPRING ENERGIZED SEALS ..... SECTION II

### Rotary Seals

Bearing and Gearbox Protection .....	36
Viscous Fluids and Powders .....	38
Restriction Bushings .....	39

### Spring Energized Seals

100 Series Cantilever Springs.....	40
200 Series Elliptical Coil Springs .....	41
300 Series Helical Wound Springs .....	42
400 Series Rotary .....	43
500 Series Stacked V-rings .....	44

## ENGINEERING GUIDELINES ..... SECTION III

### Engineering Guidelines

SpeedSeal Profiles and Descriptions .....	52
Design Guidelines .....	63
Materials Matrix .....	72
Fluid Compatibility .....	78
Troubleshooting Guide .....	83
Engineering Action Request Form.....	89

## PRODUCT INDEX ..... 91

# CHESTERTON®

Providing value to industry since 1884

A.W. Chesterton Company is a leading international manufacturer and distributor of five distinct product lines. Each product line is positioned to provide value-driven solutions to meet industry needs.

Since 1884 we have worked closely with our customers to provide solutions that help them operate more reliably, efficiently, and economically.

*A.W. Chesterton Company is ISO 9001/14001 and MRP II Class-A certified.*

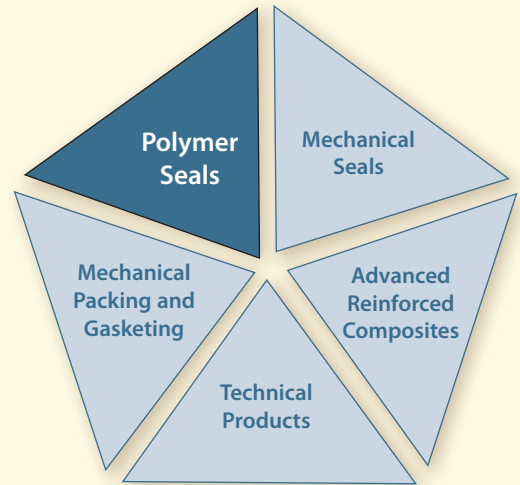

## Global Solutions

Chesterton has been providing value-driven solutions around the globe with documented success and recognition by using high performance materials and designs to solve your toughest sealing needs.



## Local Service

The expertise of your local Chesterton Technical Specialist and the support of our engineering staff will enable you to enjoy significantly reduced operating costs, increased reliability, and years of trouble-free service.

---

# ENGINEERED POLYMER SOLUTIONS

Dedicated to quality and reliability

Chesterton's Engineered Polymer Solutions Group is a worldwide manufacturer and distributor of the highest performing polymer seals. We combine our technical expertise with state-of-the-art material technologies to provide industry-leading solutions.

- Hydraulic and pneumatic seals
- Rotary seals
- Spring energized seals
- Custom seals
- Service programs



## Materials and Innovation

We utilize the full range of state-of-the-art polymer technologies to support a wide range of industrial applications.



## Designs and Expertise

Our engineers draw on years of experience to design value-added products with a focus on continuously improving equipment performance.



## Solutions and Service

Our distributors and specialists work closely with customers to provide the best service in the industry.

*For more information about Chesterton and its products, please visit [www.chesterton.com](http://www.chesterton.com)*

# HOW TO USE THIS CATALOG

## USAGE

The catalog can be used to locate product using two different methods:

- By means of the **Table of Contents**
- By means of the **Product Guidelines Chart**

### Table of Contents

Search the table of contents based on product type to quickly identify products offered.

- **Section I** – Hydraulic and Pneumatic Seals  
*Includes wipers, rod seals, piston seals and ancillary devices.*
- **Section II** – Rotary and Spring Energized Seals  
*Includes lip seals, restriction bushings, and spring energized seals.*
- **Section III** – Engineering Guidelines  
*Includes profiles and descriptions, materials reference, fluid compatibility guide, design guidelines, and trouble shooting guide.*

**Table of Contents**

**CHESTERTON OVERVIEW**  
 Overview of Chesterton and Engineered Polymer Solutions Group ... Introduction 06  
 How to Use this Catalog 06  
 Product Guidelines 08  
 Catalog Legend 09

**HYDRAULIC AND PNEUMATIC SEALS SECTION I**

**Wipers**  
 Standard 14  
 Carved 15

**Rod Seals**  
 U-cup 16  
 Stacked Set 21  
 Compression 24  
 Static 27

**Piston Seals**  
 U-cup 16  
 Stacked Set 21  
 Compression 24  
 Piston Cup 26  
 Static 27

**Ancillary Devices**  
 Bearing Bands 30  
 Anti-extrusion Rings 28  
 Bearing Coils 29

**ROTARY AND SPRING ENERGIZED SEALS SECTION II**

**Rotary Seals**  
 Bearing and Gearbox Protection 36  
 Restrictor Bushings 39  
 Cartridge Seal 38

**Spring Energized Seals**  
 100 Series Cantilever Springs 40  
 200 Series Elliptical Coil Springs 41  
 300 Series Helical Whisker Springs 42  
 400 Series Rotary 43  
 500 Series Stacked 44

**ENGINEERING GUIDELINES SECTION III**

**Engineering Guidelines**  
 Product Profiles and Descriptions 52  
 Materials Matrix 76  
 Chemical Compatibility 82  
 Design Guidelines 65  
 Engineering Action Request Form 93  
 Trouble Shooting 87

### Product Guidelines Chart

Use the Product Guidelines Chart if help is required to identify the appropriate product for your application. The product matrix was developed using application speed as the foundation.

- Confirm application speed
- Identify product offerings
- Locate page to review details

**Polymer Seals**

**PRODUCT GUIDELINES**

**PRODUCT GUIDELINES (Hydraulic and Pneumatic Applications)**

Speed	Seal Type	Product	Profile	Description	1000	500	250	125	63	32	16	8	4
Reciprocating	Wiper	WIP-100	WIP-100	Standard	✓	✓	✓	✓	✓	✓	✓	✓	✓
				Carved	✓	✓	✓	✓	✓	✓	✓	✓	✓
	Rod Seal	RS-100	RS-100	U-cup	✓	✓	✓	✓	✓	✓	✓	✓	✓
				Stacked Set	✓	✓	✓	✓	✓	✓	✓	✓	
				Compression	✓	✓	✓	✓	✓	✓	✓	✓	
				Static	✓	✓	✓	✓	✓	✓	✓	✓	
	Piston Seal	PS-100	PS-100	U-cup	✓	✓	✓	✓	✓	✓	✓	✓	✓
				Stacked Set	✓	✓	✓	✓	✓	✓	✓	✓	
				Compression	✓	✓	✓	✓	✓	✓	✓	✓	
				Piston Cup	✓	✓	✓	✓	✓	✓	✓	✓	
	Ancillary Device	AD-100	AD-100	Bearing Bands	✓	✓	✓	✓	✓	✓	✓	✓	✓
				Anti-extrusion Rings	✓	✓	✓	✓	✓	✓	✓	✓	
Rotary	Restrictor Bushing	RB-100	RB-100	Standard	✓	✓	✓	✓	✓	✓	✓	✓	
				Carved	✓	✓	✓	✓	✓	✓	✓	✓	
				100 Series	✓	✓	✓	✓	✓	✓	✓	✓	
				200 Series	✓	✓	✓	✓	✓	✓	✓	✓	
	Cartridge Seal	CS-100	CS-100	Standard	✓	✓	✓	✓	✓	✓	✓	✓	✓
				Carved	✓	✓	✓	✓	✓	✓	✓	✓	
				100 Series	✓	✓	✓	✓	✓	✓	✓	✓	
				200 Series	✓	✓	✓	✓	✓	✓	✓	✓	
	Spring Energized Seal	SES-100	SES-100	100 Series	✓	✓	✓	✓	✓	✓	✓	✓	✓
				200 Series	✓	✓	✓	✓	✓	✓	✓	✓	
				300 Series	✓	✓	✓	✓	✓	✓	✓	✓	
				400 Series	✓	✓	✓	✓	✓	✓	✓	✓	

**PRODUCT GUIDELINES (Rotary Applications)**

Speed	Seal Type	Product	Profile	Description	1000	500	250	125	63	32	16	8	4
Rotary	Restrictor Bushing	RB-100	RB-100	Standard	✓	✓	✓	✓	✓	✓	✓	✓	✓
				Carved	✓	✓	✓	✓	✓	✓	✓	✓	✓
				100 Series	✓	✓	✓	✓	✓	✓	✓	✓	
				200 Series	✓	✓	✓	✓	✓	✓	✓	✓	
	Cartridge Seal	CS-100	CS-100	Standard	✓	✓	✓	✓	✓	✓	✓	✓	✓
				Carved	✓	✓	✓	✓	✓	✓	✓	✓	
				100 Series	✓	✓	✓	✓	✓	✓	✓	✓	
				200 Series	✓	✓	✓	✓	✓	✓	✓	✓	
	Spring Energized Seal	SES-100	SES-100	100 Series	✓	✓	✓	✓	✓	✓	✓	✓	✓
				200 Series	✓	✓	✓	✓	✓	✓	✓	✓	
				300 Series	✓	✓	✓	✓	✓	✓	✓	✓	
				400 Series	✓	✓	✓	✓	✓	✓	✓	✓	

**CHESTERTON**  
Global Solutions, Local Service.

**PRODUCT SECTION**

Reference the product section where all products are listed by type. Each product datasheet contains the following information.

- A** Product name and type
- B** Product description
- C** Technical data
- D** Equipment drawing
- E** Family of profiles
- F** How to place an order
- G** Features and benefits

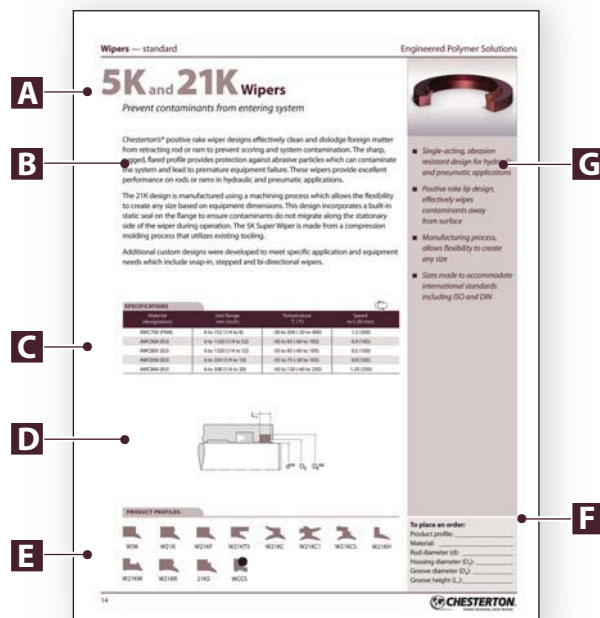

**PLACING AN ORDER**

To place an order, the required information is needed:

- Product profile
- Product material
- Equipment dimensions

**For example:**

To place an order for a hydraulic rod seal with a 50 mm rod diameter, a bore diameter of 70 mm and a stuffing box height of 15 mm, the following information is required.

**To place an order: Rod Seal**

Product Profile	R10K
Material (AWC designation)	AWC800
Rod diameter (d)	50 mm
Bore diameter (D <sub>1</sub> )	70 mm
Groove height (L <sub>1</sub> )	15 mm

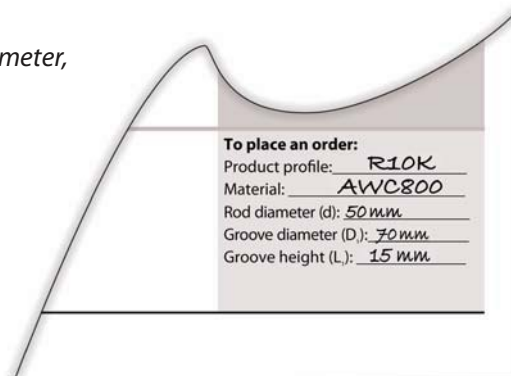

# PRODUCT GUIDELINES

PRODUCT GUIDELINES (Hydraulic and Pneumatic Applications*)																			
Motion	Speed	Types	Product Series	Profile	Description	Attributes					Friction			Wear			Page #		
						mold	**mach	hyd.	pne.	split	L	M	H	L	M	H			
RECIPROCATING	to 15 m/sec (3000 ft/min)	Rod seals, Compression, Cap seals	RCCS		Double acting, dual component seal		✓	✓	✓		✓				✓		25		
			PCCS		Double acting, dual component seal		✓	✓	✓		✓					✓		25	
	to 1 m/s (185 ft/min)	Wipers	W5K, W21K		Positive angled profile with flange	✓	✓	✓	✓	✓	✓				✓		14		
			CW21K		Positive angled profile with press fit can		✓	✓	✓			✓				✓		15	
		Rod Seals, U-cups	R10K, R22KN		Single acting, positive angled profile	✓	✓	✓	✓		✓					✓		16	
			R22K		Single acting, negative angled profile		✓	✓				✓					✓		17
			R22KE		Single acting, negative angled profile with O-ring loader		✓	✓					✓				✓		18
			R23K		Single acting, radiused sealing surface for pneumatic applications		✓		✓		✓				✓				19
			R6K		Single acting, positive angled profile for worn equipment	✓		✓						✓				✓	20
			R8K, R27K		Single acting, positive angled profile, dual stacked set	✓	✓	✓		✓		✓					✓		22
		Rod seals, Stacked sets	R11K		Single acting, negative angled profile, dual stacked set	✓	✓	✓		✓		✓					✓		21
			R600		Single acting, positive angled, stacked set for worn equipment	✓		✓		✓				✓				✓	23
			P10K, P22KN		Single acting, positive angled profile	✓		✓	✓		✓					✓			16
		Piston seals, U-cups	P22K		Single acting, negative angled profile		✓	✓				✓					✓		17
			P22KE		Single acting, negative angled profile with O-ring loader		✓	✓					✓				✓		18
			P23K		Single acting, radiused sealing surface for pneumatic applications		✓		✓		✓				✓				19
			P8K, P27K		Single acting, positive angled profile, multiple stacked set	✓		✓		✓				✓				✓	22
		Piston cup	P7K		Single acting, positive angled piston cup	✓	✓	✓	✓			✓					✓		26
		Replaceable bearings	16K, 17K		Metric and English size bearing band strips for large diameters	✓		✓	✓	✓	✓					✓			29
			18K, 19K		Metric and English size bearing bands	✓		✓	✓	✓	✓					✓			30
			WR		Custom wear rings for bearing support		✓	✓	✓	✓	✓					✓			31
		Anti-extrusion rings	9K		Backup rings or anti-extrusion rings		✓	✓	✓	✓	✓					✓			28
	to 0.25 m/s (50 ft/min)	Compression seals, (rod & piston)	R20K, P20K		Double acting, negative angled profile, low speed hydraulic applications		✓	✓				✓				✓		24	
	Static	Face seals	R20KDR, P20KDR		Static seal for O-ring upgrades		✓	✓	✓		✓					✓		27	

PRODUCT GUIDELINES (Rotary Applications*)																		
Motion	Speed	Types	Product Series	Profile	Description	Attributes					Friction			Wear			Page #	
						mold	**mach	hyd.	pne.	split	L	M	H	L	M	H		
ROTARY	to 20 m/s (4000 ft/min)	Custom lip seals	400 series		Single rotary seals for highly dynamic applications		✓	✓	✓		✓				✓		43	
		Continuous rotary lip seals	30K		Single acting, low pressure seal for bearing & gearbox protection		✓	✓	✓		✓				✓			36
	to 12.5 m/s (2500 ft/min)	Split rotary lip seals	33K		Single acting, non-pressure split seal for bearing & gearbox protection		✓			✓	✓				✓		37	
	to 6 m/s (1200 ft/min)	Elliptical coil spring energized	200 Series		Single acting with elliptical spring for large tolerances or miniature designs		✓	✓	✓			✓				✓		41
	to 5 m/s (1000 ft/min)	Cantilever coil spring energized	100 Series		Single acting with cantilever spring for highly dynamic applications		✓	✓	✓			✓				✓		40
	to 2.5 m/s (500 ft/min)	Helical coil spring energized	300 Series		Single acting with helical spring for static or slow speeds		✓	✓	✓				✓					42
		Stacked sets	500 Series		Single acting, stacked sets		✓					✓				✓		44
	to 0.5 m/s (100 ft/min)	Wipers	W5K, W21K		Positive angled profile with flange, slow rotary	✓	✓	✓	✓	✓		✓			✓			14
		Rod & Piston seals	R10K, P10K, R22KN, P22KN		Single acting, positive angled profile, slow rotary	✓	✓	✓	✓			✓				✓		16

\*Spring energized seals are available for reciprocating applications. Please contact factory.  
 \*\*Machined product does not require tooling.



# CATALOG LEGEND

## *Designations used throughout this catalog*

Notation	Description
A	Center piston landing area
b	Maximum extrusion gap
d	Rod, shaft, or ram diameter
d <sub>1</sub>	Piston seal groove diameter
d <sub>2</sub>	Piston bearing band groove diameter
d <sub>3</sub>	Wiper lock groove diameter
d <sub>4</sub>	Hold down plate diameter
d <sub>5</sub>	Piston clearance diameter
d <sub>6</sub>	L shaped, anti-extrusion ring leg inner diameter
C	Rod clearance diameter
D	Cylinder bore diameter
D <sub>1</sub>	Rod seal groove diameter/stuffing box bore
D <sub>2</sub>	Wiper housing lip clearance diameter
D <sub>3</sub>	Rod bearing band groove diameter
D <sub>4</sub>	Wiper groove diameter
D <sub>5</sub>	Wiper lock groove
E	Overall piston head length
G	Wiper/seal lock groove depth
H	Seal or wiper overall height
H <sub>1</sub>	Bearing band height
H <sub>2</sub>	Flange thickness
J	Rod seal support clearance diameter
L	Seal groove height
L <sub>1</sub>	Wiper groove height
L <sub>2</sub>	Bearing band groove height
L <sub>3</sub>	Working stuffing box height
L <sub>4</sub>	L shaped, anti-extrusion ring leg height
M	Inboard/outboard piston landing area
P	Piston seal support clearance diameter
R	Radius
R <sub>C</sub>	Running clearance
S	Cross section
I.D.	Inner diameter
O.D.	Outer diameter

# PROGRAM

## DIFFERENTIATED PRODUCTS



### SpeedSeal®

#### *Dedicated service centers*

Chesterton has increased service worldwide with the SpeedSeal Program. These fully-integrated facilities rely on advanced equipment, flexible tooling, and semi-finished material, to provide you with a broad selection of product offerings—*with same day delivery.*

- Same day delivery
- Local service
- Skilled field specialists
- Proven designs
- Technical expertise
- Made to order product
- Reliable brand
- Superior materials

### Engineered Solutions

#### *High performance custom seals*

We leverage our engineering experience in design and materials to develop custom seals that solve today's most difficult sealing challenges. Our custom designs provide leading edge technology that has been used around the world with documented success and recognition.

- Pumps and compressors
- Dispensing equipment
- Metering instruments
- Swivel joints
- Actuators
- Analyzers
- Semiconductor units
- Propulsion units
- Motors and gearboxes
- Valves



# S

## AND OFFERINGS

### Molded Seals

*Industry's best delivery*

Chesterton has been designing and fabricating molded seals for decades. Our extensive tooling library includes thousands of tools, in both inch and metric sizes, with capabilities up to two meters in diameter. This wide range of tooling allows us to offer the best deliveries in the industry for large diameter seals.

- Specialize in large diameters
- Extensive tooling inventory
- Standard inch and metric sizes
- Custom sizes available



### Superior Materials

*World renowned red polymer*

Chesterton's world-renowned AWC800 material is widely considered to be the highest performing material on the market today. In addition, we exploit the full range of advanced materials for the most demanding applications.

- Fluoroplastics
- Engineered plastics
- Elastomers

### Equipment Upgrade

*Systematic approach to improve MTBR*

Chesterton's equipment upgrade program applies a simplistic, systematic approach for improving seal performance during repair and overhaul of equipment. This includes seals, bearing bands, and custom kits for cylinders or presses used in light, medium, or heavy duty applications.

- Keep the dirt out
- Keep the fluid in
- Support the system

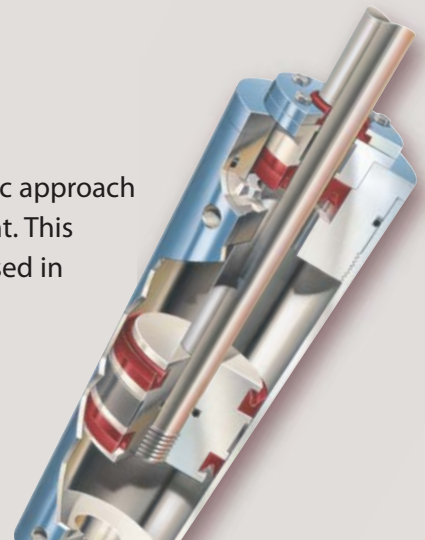





# HYDRAULIC AND PNEUMATIC SEALS

*A.W. Chesterton Company is a worldwide manufacturer and distributor of the highest-performing sealing devices. A combination of our unique products, the support of local field specialists, and the expertise of our engineering staff will enable you to enjoy increased reliability and years of trouble-free service.*

*This section includes information pertaining to the hydraulic, pneumatic, and ancillary products offered through Chesterton.*

## **Section I**

- Wipers
- Rod Seals
- Piston Seals
- Ancillary Devices

# 5K and 21K Wipers

Prevent contaminants from entering system

Chesterton® positive rake wipers are designed to effectively clean and dislodge foreign matter from retracting rods or rams to prevent scoring and system contamination. The sharp, rugged, flared profile provides protection against abrasive particles which can contaminate the system and lead to premature equipment failure. These wipers provide excellent performance on rods or rams in hydraulic and pneumatic applications.

The 21K design is manufactured using a machining process which allows the flexibility to create any size based on equipment dimensions. This design incorporates a built-in static seal on the flange to ensure contaminants do not migrate along the stationary side of the wiper during operation. The 5K Super Wiper is made from a compression molding process that utilizes existing tooling.

Additional custom designs were developed to meet specific application and equipment needs which include snap-in, stepped, and bi-directional wipers.

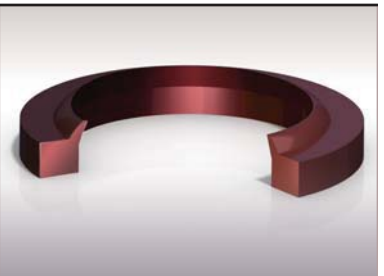

- Single-acting, abrasion-resistant design for hydraulic and pneumatic applications
- Positive rake lip design effectively wipes contaminants away from surface
- Manufacturing process allows flexibility to create any size
- Sizes made to accommodate international standards including ISO and DIN

**SPECIFICATIONS**

Material (designation)	Size Range mm (inch)	Temperature °C (°F)	Speed m/s (ft/min)
AWC700 (FKM)	6 to 152 (1/4 to 6)	-30 to 200 (-20 to 400)	1.5 (300)
AWC800 (EU)	6 to 1320 (1/4 to 52)	-50 to 85 (-60 to 185)	0.9 (185)
AWC805 (EU)	6 to 1320 (1/4 to 52)	-50 to 85 (-60 to 185)	0.5 (100)
AWC830 (EU)	6 to 254 (1/4 to 10)	-35 to 75 (-30 to 165)	0.9 (185)
AWC860 (EU)	6 to 508 (1/4 to 20)	-50 to 120 (-60 to 250)	1.25 (250)

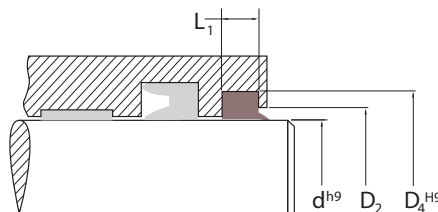

**PRODUCT PROFILES:**

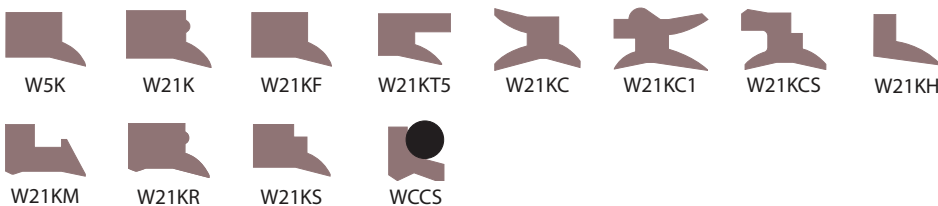

**To place an order:**

Product profile: \_\_\_\_\_  
 Material: \_\_\_\_\_  
 Rod diameter (d): \_\_\_\_\_  
 Housing diameter (D<sub>2</sub>): \_\_\_\_\_  
 Groove diameter (D<sub>4</sub>): \_\_\_\_\_  
 Groove height (L<sub>1</sub>): \_\_\_\_\_

# 21K Canned Wipers

*Prevent contaminants from entering system*

Chesterton® positive rake wipers are designed to effectively clean and dislodge foreign matter from retracting rods or rams to prevent scoring and system contamination in open cavity designs. These wipers provide excellent performance for hydraulic applications.

The CW21K is manufactured from a machining process which allows the flexibility to create any size based on equipment dimensions. The canned portion of the seal provides stability due to an interference fit that allows it to be pressed into an open cavity gland design.

These wipers are available in various material combinations based on equipment requirements while the canned\* portion of the seal can be manufactured from metallic material and other engineered plastics.

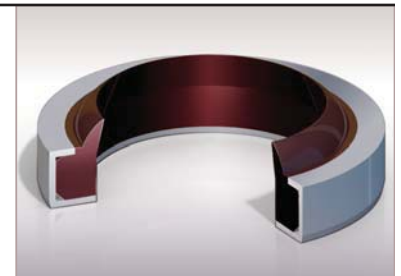

- *Interference press fit design does not require support of other external devices*
- *Single-acting, abrasion-resistant design for hydraulic applications*
- *Positive rake lip design effectively wipes contaminants away from surface*
- *Manufacturing process allows flexibility to create any size*
- *Sizes made to accommodate international standards including ISO and DIN*

**SPECIFICATIONS**

Material (designation)	Size Range mm (inch)	Temperature °C (°F)	Speed m/s (ft/min)
AWC700 (FKM)	6 to 152 (1/4 to 6)	-30 to 200 (-20 to 400)	1.5 (300)
AWC800 (EU)	6 to 1320 (1/4 to 52)	-50 to 85 (-60 to 185)	0.9 (185)
AWC830 (EU)	6 to 254 (1/4 to 10)	-35 to 75 (-30 to 165)	0.9 (185)
AWC860 (EU)	6 to 508 (1/4 to 20)	-50 to 120 (-60 to 250)	1.25 (250)

\*Can material: AWC 650 (POM) or AWC665 (Nylon)

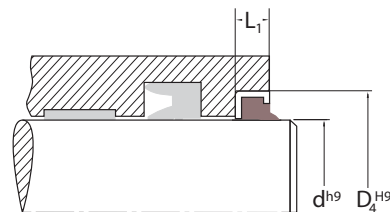

**PRODUCT PROFILES:**

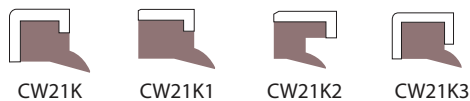

**To place an order:**

Product profile: \_\_\_\_\_  
 Material: \_\_\_\_\_  
 Rod diameter (d): \_\_\_\_\_  
 Groove diameter (D<sub>g</sub>): \_\_\_\_\_  
 Groove height (L<sub>1</sub>): \_\_\_\_\_

# 10K and 22KN Rod and Piston Seals

*Ideal design for hydraulic and pneumatic sealing*

Chesterton® 10K Super Monoseal® and 22KN are single-acting, U-cup designs. The positive rake, lip profile provides an optimal amount of radial sealing load with minimal frictional resistance. This seal design is offered as a rod or piston seal and provides outstanding performance in both hydraulic and pneumatic applications.

The 10K Super Monoseal® is made from a custom molding process that utilizes existing tooling. The 22KN design is manufactured using a machining process which allows the flexibility to create any size based on equipment dimensions.

A number of unique designs have been derived from the original 10K to address specific needs and applications in the market. These include designs to address pressure reversal, pressure spikes, and system vacuuming.

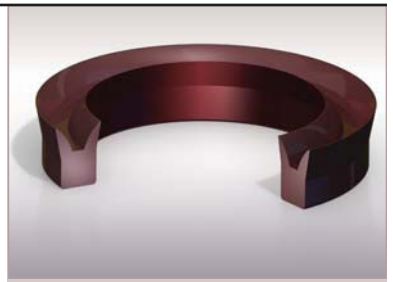

- *Single-acting, U-cup design minimizes frictional resistance*
- *Positive rake lip design wipes contaminants away from mating surface*
- *Abrasion-resistant design, outstanding performance in hydraulic and pneumatic applications*
- *Manufacturing process allows flexibility to create any size*
- *Sizes made to accommodate international standards including ISO and DIN*

**SPECIFICATIONS**

Material (designation)	Size Range mm (inch)	Temperature °C (°F)	Pressure bar (psi)	Speed m/s (ft/min)
AWC700 (FKM)	6 to 152 (1/4 to 6)	-30 to 200 (-20 to 400)	345 (5,000)	1.5 (300)
AWC800 (EU)	6 to 1320 (1/4 to 52)	-50 to 85 (-60 to 185)	1035 (15,000)	0.9 (185)
AWC805 (EU)	6 to 1320 (1/4 to 52)	-50 to 85 (-60 to 185)	1035 (15,000)	0.5 (100)
AWC830 (EU)	6 to 254 (1/4 to 10)	-35 to 75 (-30 to 165)	520 (7,500)	0.9 (185)
AWC860 (EU)	6 to 508 (1/4 to 20)	-50 to 120 (-60 to 250)	1035 (15,000)	1.25 (250)

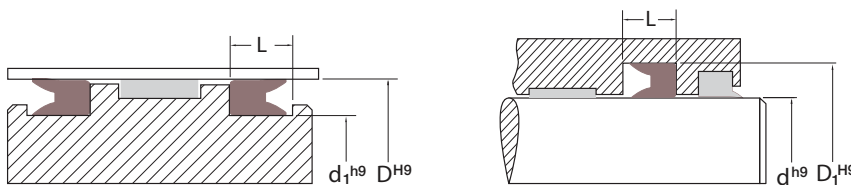

**PRODUCT PROFILES:**



**To place an order:**  
 Product profile: \_\_\_\_\_  
 Material: \_\_\_\_\_  
 Rod or ram diameter (d): \_\_\_\_\_  
 Bore diameter (D<sub>1</sub>): \_\_\_\_\_  
 Groove height (L): \_\_\_\_\_

**To place an order:**  
 Product profile: \_\_\_\_\_  
 Material: \_\_\_\_\_  
 Piston groove diameter (d<sub>1</sub>): \_\_\_\_\_  
 Cylinder bore diameter (D): \_\_\_\_\_  
 Groove height (L): \_\_\_\_\_



# 22K Rod and Piston Seals

*Special geometry provides optimal hydraulic sealing*

The Chesterton® 22K is a single-acting, U-cup design with a special seal lip geometry that provides zero leakage throughout the entire operating range. The sturdy, static lip stabilizes the seal to prevent rolling while the dynamic lip design eliminates issues associated with low pressure sealing, provides additional stability, and eases installation. This seal design is offered as a rod or piston seal and provides excellent performance in hydraulic applications.

The 22K design is manufactured using a machining process which allows the flexibility to create any size based on equipment dimensions.

A number of additional designs have been derived from the original 22K design to address specific needs and applications in the market. These include the use of anti-extrusion rings for use in equipment with excessive clearances.



- *Single-acting, U-cup design, zero leakage throughout the entire operating range*
- *Abrasion-resistant design, excellent performance in hydraulic applications*
- *Lip geometry, stabilizes seal to prevent rolling and eases installation*
- *Machining process allows the flexibility to create any size*
- *Sizes made to accommodate international standards including ISO and DIN*

**SPECIFICATIONS**

Material (designation)	Size Range mm (inch)	Temperature °C (°F)	Pressure bar (psi)	Speed m/s (ft/min)
AWC700 (FKM)	6 to 152 (1/4 to 6)	-30 to 200 (-20 to 400)	345 (5,000)	1.5 (300)
AWC800 (EU)	6 to 1320 (1/4 to 52)	-50 to 85 (-60 to 185)	1035 (15,000)	0.9 (185)
AWC830 (EU)	6 to 254 (1/4 to 10)	-35 to 75 (-30 to 165)	520 (7,500)	0.9 (185)
AWC860 (EU)	6 to 508 (1/4 to 20)	-50 to 120 (-60 to 250)	1035 (15,000)	1.25 (250)

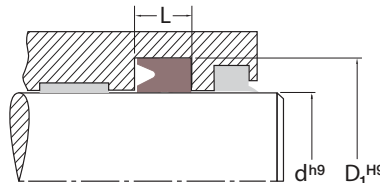
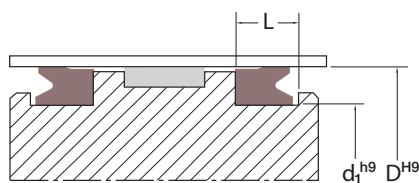

**PRODUCT PROFILES:**



**To place an order:**

Product profile: \_\_\_\_\_  
 Material: \_\_\_\_\_  
 Rod or ram diameter (d): \_\_\_\_\_  
 Bore diameter (D<sub>1</sub>): \_\_\_\_\_  
 Groove height (L): \_\_\_\_\_

**To place an order:**

Product profile: \_\_\_\_\_  
 Material: \_\_\_\_\_  
 Piston groove diameter (d<sub>1</sub>): \_\_\_\_\_  
 Cylinder bore diameter (D): \_\_\_\_\_  
 Groove height (L): \_\_\_\_\_

# 22KE Rod and Piston Seals

*Energized dual component for added stability*

The Chesterton® 22KE is a single-acting, continuous U-cup design which incorporates the use of an O-ring to increase pre-load capabilities. The O-ring energizes the seal in the absence of system pressure and provides stability at higher temperatures. This seal design is offered as a rod or piston seal and provides excellent performance in hydraulic applications.

The 22KE design is manufactured using a machining process which allows the flexibility to create any size based on equipment dimensions. The special seal lip geometry provides an optimal preload to maximize performance while the negative rake design eases installation.

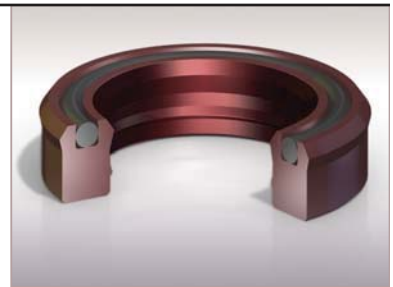

- Single-acting U-cup design, zero leakage throughout the entire operating range
- O-ring loader energizes seal and provides stability at higher pressures
- Abrasion-resistant design, excellent performance in hydraulic applications
- Lip geometry stabilizes seal to prevent rolling and eases installation
- Machining process allows the flexibility to create any size

SPECIFICATIONS				
*Material (designation)	Size Range mm (inch)	Temperature °C (°F)	Pressure bar (psi)	Speed m/s (ft/min)
AWC700 (FKM)	6 to 152 (1/4 to 6)	- 30 to 200 (-20 to 400)	345 (5,000)	1.5 (300)
AWC800 (EU)	6 to 1320 (1/4 to 52)	-50 to 85 (-60 to 185)	1035 (15,000)	0.9 (185)
AWC830 (EU)	6 to 254 (1/4 to 10)	-35 to 75 (-30 to 165)	520 (7,500)	0.9 (185)
AWC860 (EU)	6 to 508 (1/4 to 20)	-50 to 120 (-60 to 250)	1035 (15,000)	1.25 (250)

\*O-ring material is FKM

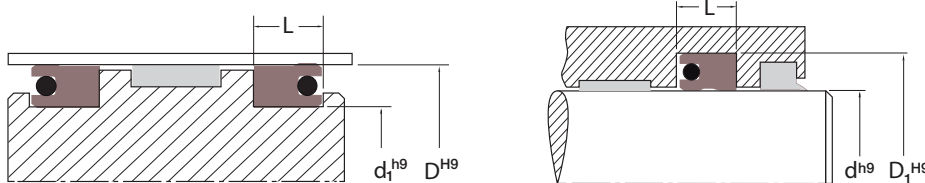

**PRODUCT PROFILES:**



**To place an order:**  
 Product profile: \_\_\_\_\_  
 Material: \_\_\_\_\_  
 Rod or ram diameter (d): \_\_\_\_\_  
 Diameter (D<sub>1</sub>): \_\_\_\_\_  
 Groove height (L): \_\_\_\_\_

**To place an order:**  
 Product profile: \_\_\_\_\_  
 Material: \_\_\_\_\_  
 Piston groove diameter (d<sub>1</sub>): \_\_\_\_\_  
 Cylinder bore diameter (D): \_\_\_\_\_  
 Groove height (L): \_\_\_\_\_

# 23K Rod and Piston Seals

*Optimum geometry for pneumatic sealing*

The Chesterton® 23K seal is a single-acting, U-cup design that incorporates a unique, dynamic lip geometry that provides the optimal sealing force required for low pressure pneumatic applications.

The 23K design is manufactured using a machining process which allows the flexibility to create any size based on equipment dimensions. The radiused lip design ensures a continuous lubricating film is maintained which minimizes operating temperature and wear delivering excellent sealing performance.



- *Unique lip geometry provides optimal sealing force for pneumatic applications*
- *Radiused lip design ensures a continuous lubricating film, minimizing wear*
- *Machining process allows the flexibility to create any size*
- *Sizes made to accommodate international standards including ISO and DIN*

**SPECIFICATIONS**

Material (designation)	Size Range mm (inch)	Temperature °C (°F)	Pressure bar (psi)	Speed m/s (ft/min)
AWC700 (FKM)	6 to 152 (1/4 to 6)	-30 to 200 (-20 to 400)	9 (125)	1.5 (300)
AWC800 (EU)	6 to 1320 (1/4 to 52)	-50 to 85 (-60 to 185)		0.9 (185)
AWC830 (EU)	6 to 254 (1/4 to 10)	-35 to 75 (-30 to 165)		0.9 (185)
AWC860 (EU)	6 to 508 (1/4 to 20)	-50 to 120 (-60 to 250)		1.25 (250)

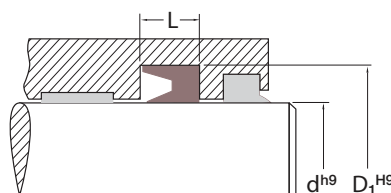
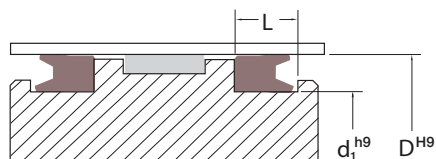

**PRODUCT PROFILES:**



**To place an order:**

Product profile: \_\_\_\_\_  
 Material: \_\_\_\_\_  
 Rod or ram diameter (d): \_\_\_\_\_  
 Bore diameter (D<sub>1</sub>): \_\_\_\_\_  
 Groove height (L): \_\_\_\_\_

**To place an order:**

Product profile: \_\_\_\_\_  
 Material: \_\_\_\_\_  
 Piston groove diameter (d<sub>1</sub>): \_\_\_\_\_  
 Cylinder bore diameter (D): \_\_\_\_\_  
 Groove height (L): \_\_\_\_\_

# 6K Rod Seals

*Rugged construction for older, worn equipment*

The Chesterton® 6K is a single-acting, U-cup design with a positive rake lip design that wipes contaminants away for the mating surface while in operation. The rugged, rubber-based construction is ideal for older, worn equipment since it conforms to surface irregularities to effectively control leakage. This rod seal design provides outstanding performance in older, worn hydraulic cylinders and presses.

The 6K is made from a custom molding process that utilizes existing tooling. Each seal is individually manufactured from a base rubber-reinforced material.

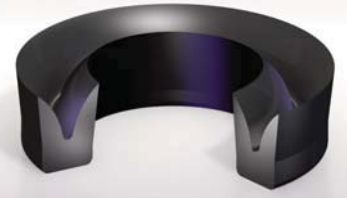

- Positive rake profile wipes contaminants away for the mating surface
- Rugged base construction designed for older, worn equipment
- Rubber-based material conforms to surface irregularities to control leakage
- Neoprene-based materials perform well in water and oil
- Butyl-based material performs well in phosphate ester fluids

**SPECIFICATIONS**

Material (designation)	Size Range mm (inch)	Temperature °C (°F)	Pressure bar (psi)	Speed m/s (ft/min)
AWC735 neoprene (NR)	100 to 1,143 (4 to 45)	- 25 to 121 (- 13 to 250)	207 (3000)	0.6 (120)
AWC747 butyl (IIR)	100 to 1,143 (4 to 45)	- 25 to 121 (- 13 to 250)	207 (3000)	0.6 (120)

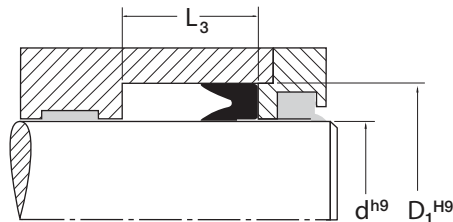

**PRODUCT PROFILES:**



R6K

**To place an order:**

Product profile: \_\_\_\_\_  
 Material: \_\_\_\_\_  
 Rod diameter (d): \_\_\_\_\_  
 Stuffing box bore (D<sub>1</sub>): \_\_\_\_\_  
 Groove height (L): \_\_\_\_\_

# 11K Rod Seals

*Dual component, split stacked set for hydraulic sealing*

The Chesterton® patented 11K EZ Stack Pack is a single acting, two-piece split stacked set that employs a negative rake lip profile to optimize operating performance while easing installation into the stuffing box cavity. The unique, split design, made up of two components, eliminates the need for equipment disassembly and shimming and is recommended for use in hydraulic cylinders and presses.

The 11K EZ Stack Pack can be manufactured using either the traditional compression molded process or a machining process which allows the flexibility to create any size based on equipment dimensions.

The bottom ring is the primary sealer while the top ring provides secondary sealing and works as an anti-extrusion ring. The set is available in various material combinations to accommodate new or used equipment and can be supplied in split or solid designs.

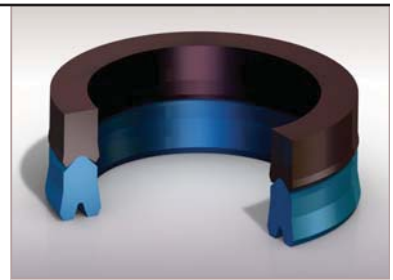

- *Patented split design eliminates the need to disassemble equipment*
- *Negative lip profile optimizes operating performance and eases installation*
- *No shimming, eliminate tedious calculations and future adjustments*
- *Dual material combination works on both new and worn equipment*
- *Sizes made to accommodate international standards including ISO and DIN*

**SPECIFICATIONS**

Material (designation)	Size Range mm (inch)	Temperature °C (°F)	Pressure bar (psi)	Speed m/s (ft/min)
AWC700 (FKM)	6 to 152 (1/4 to 6)	-30 to 200 (-20 to 400)	345 (5,000)	1.5 (300)
AWC800 (EU)	6 to 1320 (1/4 to 52)	-50 to 85 (-60 to 185)	1035 (15,000)	0.9 (185)
AWC805 (EU)	6 to 1320 (1/4 to 52)	-50 to 85 (-60 to 185)	1035 (15,000)	0.5 (100)
AWC830 (EU)	6 to 254 (1/4 to 10)	-35 to 75 (-30 to 165)	520 (7,500)	0.9 (185)
AWC860 (EU)	6 to 508 (1/4 to 20)	-50 to 120 (-60 to 250)	1035 (15,000)	1.25 (250)

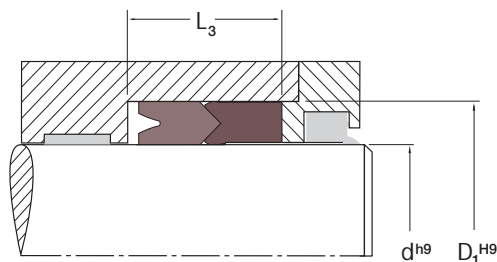

**PRODUCT PROFILES:**



**To place an order:**

Product profile: \_\_\_\_\_  
 Material: \_\_\_\_\_  
 Rod or ram diameter (d): \_\_\_\_\_  
 Bore diameter (D<sub>1</sub>): \_\_\_\_\_  
 Groove height (L<sub>3</sub>): \_\_\_\_\_

# 8K and 27K Rod and Piston Seals

*Pressure sensitive, stacked set for hydraulic sealing*

The Chesterton® 8K and 27K are single acting, stacked V-ring sets with a positive rake design to provide optimum operating performance. Unlike conventional stacked sets, these designs make contact through the center to ensure even loading, longer sealing life, and with minimal gland pressure. These sets are available in split or solid designs and provide excellent performance in closed-cavity hydraulic applications.

The 8K is a compression molded stacked set that utilizes tooling to create a final product. The 27K is manufactured using a machining process which allows the flexibility to create any size based on equipment dimensions and eliminates tooling cost for new sizes. Each set incorporates a male and female adapter to align and support the sealer rings.

Additional profiles have been derived from the original 8K design to address specific needs and applications in the market. These include designs for excessive clearances and deep stuffing boxes.

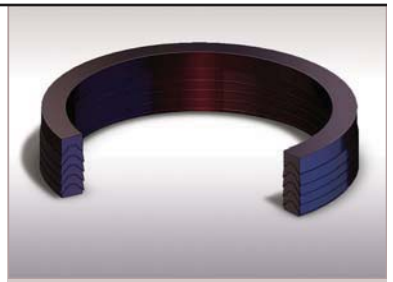

- Even stack load enables faster cycling with less friction and optimum sealing force
- Flared, pressure sensitive lip; sealing forces are reactive to pressure.
- Delivered as split components for ease of installation.
- Sizes made to accommodate international standards including ISO and DIN

**SPECIFICATIONS**

Material (designation)	Size Range mm (inch)	Temperature °C (°F)	Pressure bar (psi)	Speed m/s (ft/min)
AWC700 (FKM)	6 to 152 (1/4 to 6)	-30 to 200 (-20 to 400)	345 (5,000)	1.5 (300)
AWC800 (EU)	6 to 1320 (1/4 to 52)	-50 to 85 (-60 to 185)	1035 (15,000)	0.9 (185)
AWC805 (EU)	6 to 1320 (1/4 to 52)	-50 to 85 (-60 to 185)	1035 (15,000)	0.5 (100)
AWC830 (EU)	6 to 254 (1/4 to 10)	-35 to 75 (-30 to 165)	520 (7,500)	0.9 (185)
AWC860 (EU)	6 to 508 (1/4 to 20)	-50 to 120 (-60 to 250)	1035 (15,000)	1.25 (250)

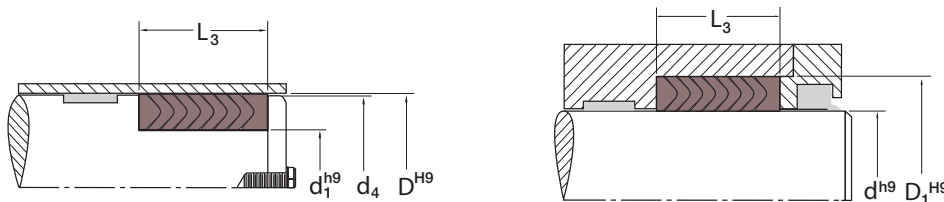

**PRODUCT PROFILES:**

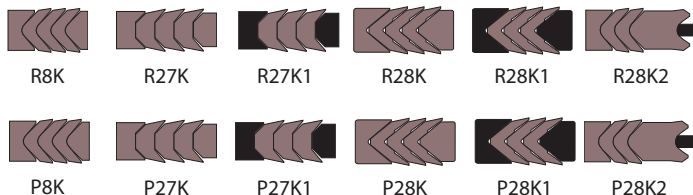

**To place an order:**

Product profile: \_\_\_\_\_  
 Material: \_\_\_\_\_  
 Piston groove diameter (d<sub>1</sub>): \_\_\_\_\_  
 Cylinder bore diameter (D): \_\_\_\_\_  
 Groove height (L): \_\_\_\_\_

**To place an order:**

Product profile: \_\_\_\_\_  
 Material: \_\_\_\_\_  
 Rod or ram diameter (d): \_\_\_\_\_  
 Bore diameter (D<sub>1</sub>): \_\_\_\_\_  
 Working height (L<sub>3</sub>): \_\_\_\_\_

# 600 Rod Seals

*Gland sensitive, stacked set for older, worn equipment*

Chesterton® 600 is a single acting, stacked V-ring set that enables the gland force transfer pressure to ensure each ring loads evenly. The rugged, rubber based construction is ideal for older, worn equipment since it conforms to surface irregularities to effectively control leakage. This seal set provides outstanding performance in hydraulic cylinders or presses.

The 600 is traditionally a compression molded stacked seal set which utilizes tooling to create a final product. The sets are available in split or continuous configurations.

Each seal ring is individually manufactured with a flat landing to ensure gland load is transferred through the set upon tightening. A male bottom adapter is designed to provide even loading, centering, and support.



- Rubber-based materials conform to surface imperfections to control leakage
- Neoprene based materials perform well in water and oil
- Butyl based material performs well in phosphate ester fluids
- Split design, ease of installation

**SPECIFICATIONS**

Material (designation)	Size Range mm (inch)	Temperature °C (°F)	Pressure bar (psi)	Speed m/s (ft/min)
AWC735 neoprene (NR)	12,7 to 914 (1/2 to 36)	-25 to 121 (-13 to 250)	345 (5000)	0.6 (120)
AWC747 butyl (IIR)	12,7 to 914 (1/2 to 36)	-25 to 121 (-13 to 250)	345 (5000)	0.6 (120)

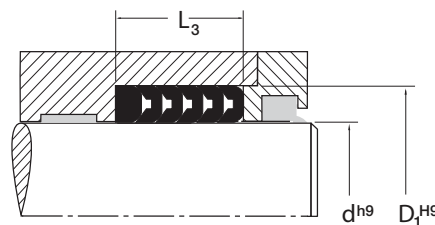

**PRODUCT PROFILES:**



R600

**To place an order:**

Product profile: \_\_\_\_\_  
 Material: \_\_\_\_\_  
 Rod or ram diameter (d): \_\_\_\_\_  
 Bore diameter (D<sub>1</sub>): \_\_\_\_\_  
 Working height (L<sub>3</sub>): \_\_\_\_\_

# 20K Rod and Piston Seals

Heavy duty bi-directional, low speed hydraulic sealing

Chesterton® 20K Duoseal is a continuous, bi-directional compression seal with dual independent sealing points. The robust, durable, dual lip profile was specifically designed for single groove cavities in heavy duty, high pressure, hydraulic applications.

The 20K Duoseals are made from our unique machining process which eliminates the need for tooling costs associated with new sizes. The heavy duty seal design has the ability to withstand pressure spikes while helping to reduce the effects of side loading.

Additional designs were developed to meet specific application and equipment needs including the incorporation of various anti-extrusion devices for combating excessive clearances and pressure spikes.

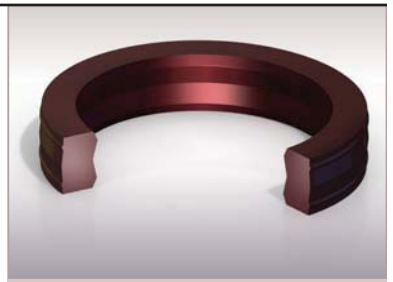

- Double acting, high pressure, hydraulic applications >35 bar (500 psi)
- Ideal replacement for 2, 3, or 4 piece cap seal assemblies
- Unique manufacturing process allows the flexibility to create any size
- Sizes made to accommodate international standards including ISO and DIN

**SPECIFICATIONS**

Material (designation)	Size Range mm (inch)	Temperature °C (°F)	Pressure bar (psi)	Speed m/s (ft/min)
AWC700 (FKM)	6 to 152 (1/4 to 6)	-30 to 200 (-20 to 400)	345 (5,000)	0.75 (150)
AWC800 (EU)	6 to 1320 (1/4 to 52)	-50 to 85 (-60 to 185)	1035 (15,000)	0.5 (100)
AWC830 (EU)	6 to 254 (1/4 to 10)	-35 to 75 (-30 to 165)	520 (7,500)	0.5 (100)
AWC860 (EU)	6 to 508 (1/4 to 20)	-50 to 120 (-60 to 250)	1035 (15,000)	0.62 (125)

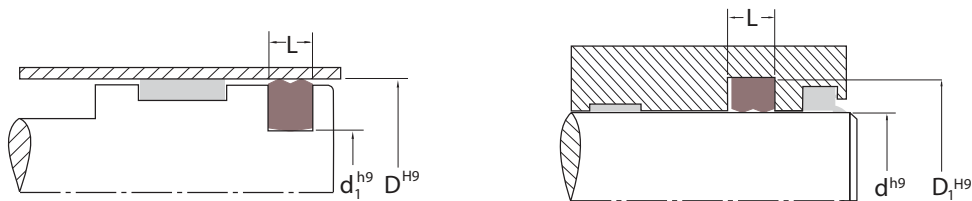

**PRODUCT PROFILES:**



**To place an order:**  
 Product profile: \_\_\_\_\_  
 Material: \_\_\_\_\_  
 Rod or ram diameter (d): \_\_\_\_\_  
 Bore diameter (D<sub>1</sub>): \_\_\_\_\_  
 Groove height (L): \_\_\_\_\_

**To place an order:**  
 Product profile: \_\_\_\_\_  
 Material: \_\_\_\_\_  
 Piston groove diameter (d<sub>1</sub>): \_\_\_\_\_  
 Cylinder bore diameter (D): \_\_\_\_\_  
 Groove height (L): \_\_\_\_\_



# CCS Rod and Piston Seals

Dual component system for bi-directional sealing

Chesterton® Custom Cap Seals (CCS) are custom manufactured, rod or piston mounted, bi-directional seals made from second generation PTFE. The second generation PTFE offers improved performance over conventional materials. Each seal is individually manufactured and provides excellent performance in single groove, double acting, hydraulic applications.

Each cap seal is made from our machining process which eliminates the need for tooling costs associated with new sizes. This cap seal design is comprised of a two-piece, sealing system that uses an elastomeric cap with an O-ring to create a very effective seal. The cap is used as the dynamic sealing element while the O-ring energizes the cap and creates a static seal.

Additional designs were developed to meet specific application and equipment needs. Both components are available in a range of engineered materials to best suit the specific operating requirements.

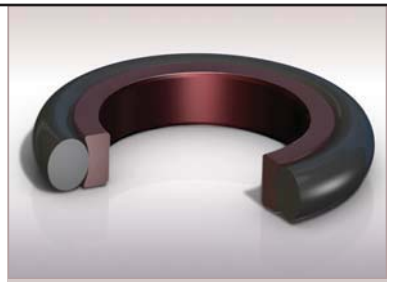

- Second generation PTFE offers improved performance
- Compression seal design increases sealing force with system pressure
- Proven seal design provides predictable performance
- Sizes made to accommodate international standards including ISO and DIN

SPECIFICATIONS				
Cap Material (designation)	Size Range mm (inch)	Temperature °C (°F)	Pressure bar (psi)	Speed m/s (ft/min) Rotary/Reciprocating
*AWC800 (EU)	19 to 380 (3/4 to 15)	-35 to 85 (-30 to 185)	345 (5,000)	0.5 (100)/0.85 (185)
*AWC860 (EU)		-35 to 120 (-30 to 250)		0.75 (150)/1.25 (250)
**AWC220 (8% glass filled PTFE)		-35 to 200 (-30 to 400)		5.0 (960)/15 (3,000)
**AWC440 (10% carbon filled PTFE)		-35 to 200 (-30 to 400)		5.0 (960)/15 (3,000)
**AWC550 (60% bronze filled PTFE)		-35 to 200 (-30 to 400)		5.0 (960)/15 (3,000)

\*Buna energizer  
\*\*FKM energizer

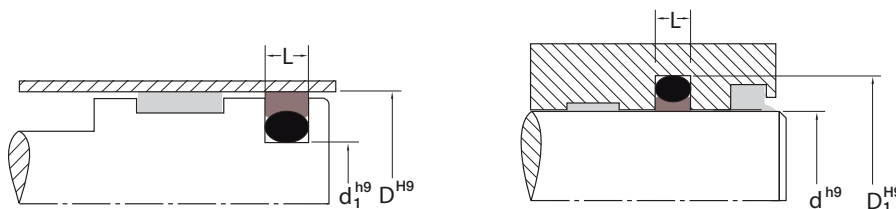

### PRODUCT PROFILES:

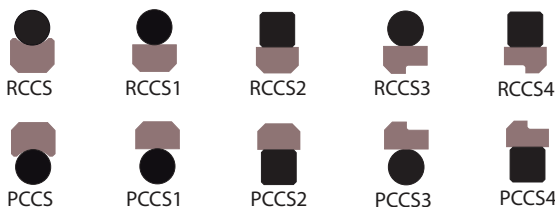

**To place an order:**  
 Product profile: \_\_\_\_\_  
 Material: \_\_\_\_\_  
 Rod or ram diameter (d): \_\_\_\_\_  
 Bore diameter (D<sub>1</sub>): \_\_\_\_\_  
 Groove height (L): \_\_\_\_\_

**To place an order:**  
 Product profile: \_\_\_\_\_  
 Material: \_\_\_\_\_  
 Piston groove diameter (d<sub>1</sub>): \_\_\_\_\_  
 Cylinder bore diameter (D): \_\_\_\_\_  
 Groove height (L): \_\_\_\_\_

# 7K Rod and Piston Seals

*Piston cup with rigid base for hydraulic sealing*

Chesterton® 7K is a single acting piston cup with a positive, flared lip design to optimize dynamic sealing forces. The rugged construction is the ideal replacement to upgrade from traditional rubber-based construction for use in hydraulic or pneumatic applications.

The 7K is manufactured from a custom compression molding process with a supporting brass disc, molded into the base. The resulting rigid base provides a stable, non-distorting, anti-extrusion resistant seal while the center-hole can be custom sized to meet your equipment-specific needs. The 7K1 is polyurethane throughout and is manufactured using a machining process that allows the flexibility to create any size based on equipment dimensions.

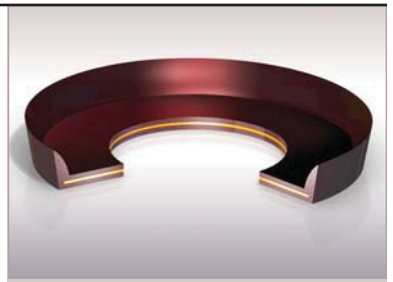

- *Positive flared lip design optimizes sealing forces*
- *Supporting metallic brass disc improves seal performance*
- *Long life cup designed to resist swelling, deformation, drag and binding*

SPECIFICATIONS				
Material (designation)	Size Range mm (inch)	Temperature °C (°F)	Pressure bar (psi)	Speed m/s (ft/min)
AWC800 (EU)	25 to 711 (1 to 28)	-50 to 85 (-60 to 185)	207 (3,000)	0.9 (185)
AWC805 (EU)	25 to 711 (1 to 28)	-50 to 85 (-60 to 185)	207 (3,000)	0.5 (100)

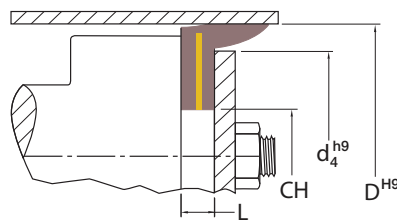

**PRODUCT PROFILES:**



**To place an order:**  
 Product profile: \_\_\_\_\_  
 Material: \_\_\_\_\_  
 Piston bore diameter (D): \_\_\_\_\_  
 Hold down plate diameter (d<sub>4</sub>): \_\_\_\_\_  
 Groove Height (L): \_\_\_\_\_  
 Center hole (CH): \_\_\_\_\_

# 20KD Face and Static Seals

*O-ring upgrade for static sealing*

Chesterton® 20K D-ring is a continuous compression seal designed for use in static applications and is often applied as an upgrade from conventional face seals or O-ring designs. This design provides excellent performance in applications found in hydraulic or pneumatic equipment including flange and valve control units.

Each seal is individually manufactured from our unique machining process which eliminates the need for tooling costs associated with new sizes.

A continuous, high performance compression seal that is most commonly designed for use in static applications and is often applied as an upgrade from conventional O-rings. Designs are available for internal face sealing as well as external face sealing commonly found in single- or double-acting applications.

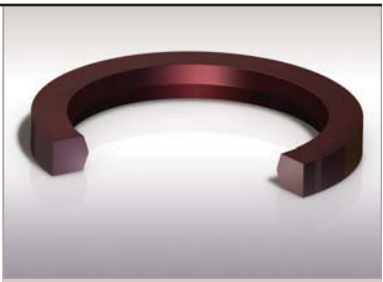

- Upgrade performance of conventional face seal and O-ring designs
- Superior wear extrusion and resistance versus conventional materials
- Low compression set characteristics
- Unique manufacturing process allows the flexibility to create any size
- Sizes made to accommodate international standards including ISO and DIN

SPECIFICATIONS			
Material (designation)	Size Range mm (inch)	Temperature °C (°F)	Pressure Bar (psi)
AWC700 (FKM)	6 to 152 (1/4 to 6)	-30 to 200 (-20 to 400)	345 (5,000)
AWC800 (EU)	6 to 1320 (1/4 to 52)	-50 to 85 (-60 to 185)	1035 (15,000)
AWC830 (EU)	6 to 254 (1/4 to 10)	-35 to 75 (-30 to 165)	517 (7,500)
AWC860 (EU)	6 to 508 (1/4 to 20)	-50 to 120 (-60 to 250)	1035 (15,000)

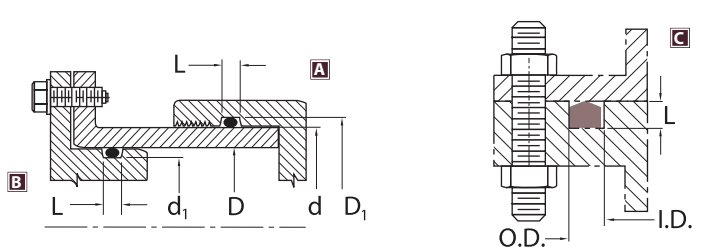

**PRODUCT PROFILES:**



**To place an order:** A  
 Product profile: \_\_\_\_\_  
 Material: \_\_\_\_\_  
 Rod or ram diameter (d): \_\_\_\_\_  
 Bore diameter (D<sub>1</sub>): \_\_\_\_\_  
 Groove height (L): \_\_\_\_\_

**To place an order:** B  
 Product profile: \_\_\_\_\_  
 Material: \_\_\_\_\_  
 Piston groove diameter (d<sub>1</sub>): \_\_\_\_\_  
 Cylinder bore diameter (D): \_\_\_\_\_  
 Groove height (L): \_\_\_\_\_

**To place an order:** C  
 Product profile: \_\_\_\_\_  
 Inner diameter (ID): \_\_\_\_\_  
 Outer diameter (OD): \_\_\_\_\_  
 Groove height (L): \_\_\_\_\_

# 9K Anti-Extrusion Rings

*Combat extrusion of hydraulic seals*

Chesterton® 9K anti-extrusion rings, often referred to as back-up rings, are designed to prevent seals or O-rings from extruding into equipment clearances while under pressure. Each ring is individually manufactured and provides excellent performance, as a supporting element, to both piston, rod and face seals that are generally found in static or dynamic applications.

Chesterton® 9K anti-extrusion rings, utilize a machining process to create a final product which enables all sizes to be made to equipment dimensions. These anti-extrusion rings are available in various extrusion-resistant materials and are located on the back-side or low pressure side of the sealing element they are supporting. Anti-extrusion rings are available in many materials and custom profiles including rectangular, contoured, continuous or split designs.



- Prevent extrusion of sealing element into equipment clearances, improve MTBR
- Static and dynamic applications, plant-wide usage
- Machining process, allows the flexibility to create any size
- Available in various profiles and materials
- Back up rings, prevent seal extrusion

SPECIFICATIONS		
Material (designation)	Size Range mm (inch)	Temperature °C (°F)
AWC800 (EU)	6 to 1320 (1/4 to 52)	- 50 to 85 (- 60 to 185)
AWC520 (Virgin PTFE)	6 to 1320 (1/4 to 52)	Cryogenic to 230 (Cryogenic to 450)
AWC650 (Acetal)	6 to 381 (1/4 to 15)	- 30 to 90 (- 20 to 200)
AWC665 (Nylon with MoS <sub>2</sub> )	>381 to 915 (>15 to 36)	- 40 to 105 (- 40 to 212)

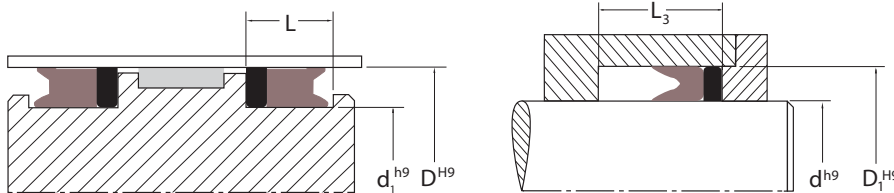

**PRODUCT PROFILES:**

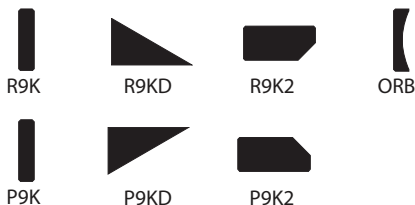

**To place an order:**  
 Product profile: \_\_\_\_\_  
 Material: \_\_\_\_\_  
 Rod or ram diameter (d): \_\_\_\_\_  
 Bore diameter (D<sub>1</sub>): \_\_\_\_\_  
 Groove height (L): \_\_\_\_\_

**To place an order:**  
 Product profile: \_\_\_\_\_  
 Material: \_\_\_\_\_  
 Piston groove diameter (d<sub>1</sub>): \_\_\_\_\_  
 Cylinder bore diameter (D): \_\_\_\_\_  
 Groove height (L<sub>3</sub>): \_\_\_\_\_

# 16K and 17K Bearing Band Strips

High performance replaceable bearing strips for presses

Chesterton® 16K and 17K replaceable Bearing Band Strips are the solution to costly cylinder re-machining and repairs for large diameter hydraulic or pneumatic equipment. These split, replaceable bearings prevent metal-to-metal scoring and reduce radial movement, therefore, extending seal and equipment life.

The split, continuous coil designs are made from a combination of composite polyester resin reinforced with synthetic fibers specifically designed to support heavy loads. The exceptional physical properties and built-in lubricants make it suitable for use on rams or pistons in reciprocating applications.



- Prevent metal-to-metal scoring, help prolong equipment life
- Reduce radial movement, extend seal life
- Built-in lubricant for lower coefficient of friction between mating surfaces
- Split continuous coil accommodates large diameter equipment

SPECIFICATIONS				
Material (designation)	*Size Range mm (inch)	Temperature °C (°F)	Compressive Strength N/mm <sup>2</sup> (psi)	Speed m/s (ft/min)
AWC640 Polyester resin graphite	300 to 1575 (12 - 62)	- 40 to 121 (- 40 to 250)	3447 (50,000)	1.0 (200)

\*Coil length = 5 meters

16K Metric Sizes		
Cross section (s), mm	(H <sub>1</sub> ), mm	Diameter range (d/D), mm
2,5	15	300 to 1575
2,5	20	
2,5	25	
4,0	25	
4,0	30	

17K Inch Sizes		
Cross section(s), inch	(H <sub>1</sub> ), in	Diameter range (d/D), inches
0.125	1.000	12 to 62
	1.500	
	2.000	

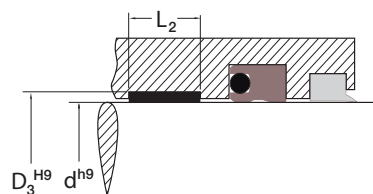
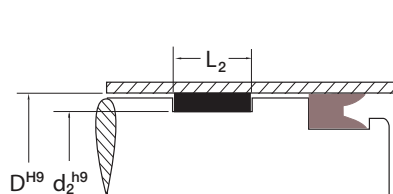

**PRODUCT PROFILES:**



16K

17K

**To place an order:**  
 Product profile: \_\_\_\_\_  
 Material: \_\_\_\_\_  
 Rod or ram diameter (d): \_\_\_\_\_  
 Groove diameter (D<sub>3</sub>): \_\_\_\_\_  
 Groove height (L<sub>2</sub>): \_\_\_\_\_

**To place an order:**  
 Product profile: \_\_\_\_\_  
 Material: \_\_\_\_\_  
 Groove diameter (d<sub>2</sub>): \_\_\_\_\_  
 Cylinder bore diameter (D): \_\_\_\_\_  
 Groove height (L<sub>2</sub>): \_\_\_\_\_

# 18K and 19K Bearing Bands

High performance replaceable bearing bands for cylinders

Chesterton® replaceable Bearing Bands are the solution to costly cylinder re-machining and repairs for hydraulic or pneumatic equipment. These split, replaceable bearing bands prevent metal-to-metal contact of moving parts and help prolong equipment life. When installed during the cylinder repair, the risk of recurring damage is significantly reduced.

The easy-to-use split 18K and 19K designs are manufactured from a glass fiber reinforced thermoplastic polyimide resin (heat stabilized nylon). These bearings reduce radial movement, therefore helping to extend seal life. The exceptional physical properties and built-in lubricants make it suitable for use on rods, rams, or pistons in reciprocating, rotary, or static applications.

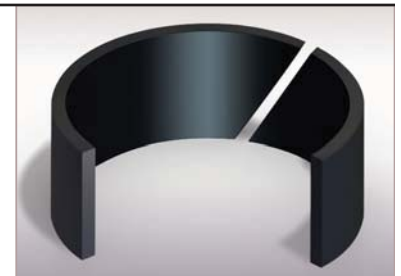

- Heat stabilized nylon, same carrying load yet less expensive than bronze
- Replaceable bearings prevent metal-to-metal scoring and prolong equipment life
- Reduce radial movement, therefore extending seal life
- Retrofit existing bearing grooves and eliminate unnecessary modifications
- Split design minimizes downtime

SPECIFICATIONS				
Material (designation)	Size Range mm (inch)	Temperature °C (°F)	Compressive Strength MP a (psi) ASTM D695	Speed m/s (ft/min)
AWC660 40% Glass -filled Nylon	to 400 (to 15.750)	- 40 to 121 (- 40 to 250)	158.8 (23,000)	1.25 (250)

19K Metric Designs		
Cross section (S), mm	Height (H <sub>1</sub> ), mm	Outer Diameter range (O. D.), mm
2,5	5	20 to 140
	9	55 to 220
	14	70 to 400
	24	315 to 400

18K Inch Designs		
Cross section (S), inch	Height (H <sub>1</sub> ), inch	Outer Diameter range (O. D.), inches
0.125	0.375	1 to 4
	0.500	1.5 to 6
	0.750	3.5 to 8
	1.000	4 to 20

\*Other materials are available upon request

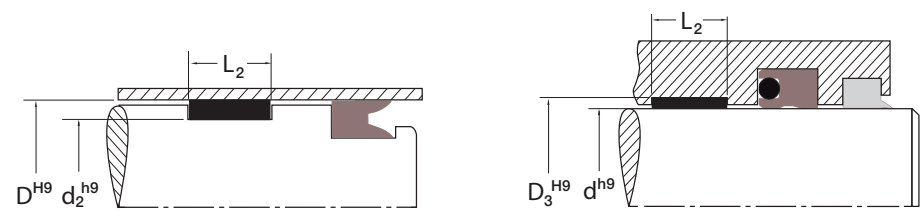

**PRODUCT PROFILES:**



18K      19K

**To place an order:**  
 Product profile: \_\_\_\_\_  
 Material: \_\_\_\_\_  
 Rod or ram diameter (d): \_\_\_\_\_  
 Groove diameter (D<sub>3</sub>): \_\_\_\_\_  
 Groove height (L<sub>2</sub>): \_\_\_\_\_

**To place an order:**  
 Product profile: \_\_\_\_\_  
 Material: \_\_\_\_\_  
 Groove diameter (d<sub>2</sub>): \_\_\_\_\_  
 Cylinder bore diameter (D): \_\_\_\_\_  
 Groove height (L<sub>2</sub>): \_\_\_\_\_

# WR Custom Wear Rings

*Custom replacement bearing bands*

Chesterton® custom wear rings are the solution to costly cylinder re-machining and repairs for hydraulic or pneumatic equipment. These split, replaceable wear rings prevent metal-to-metal contact of moving parts and help prolong equipment life. When installed during the cylinder repair, the risk of recurring damage is significantly reduced.

These wear rings reduce radial movement, therefore helping to extend seal life. The exceptional physical properties make it suitable for use on rams or pistons in reciprocating applications.

Various designs and materials are available including the WR, P9KL, R9KL, WRTP, WRTR, WRUP, WRUR, which address specific needs and applications in the market.

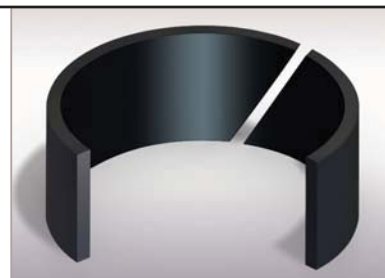

- *Replaceable bearings, cost-effective method for improving equipment performance*
- *Reduce radial movement, prevent metal-to-metal contact while extending seal life*
- *Custom wear rings eliminate unnecessary modifications*
- *Machining process, allows the flexibility to create any size*

SPECIFICATIONS				
*Material (designation)	Size Range mm (inch)	Temperature °C (°F)	Compression Strength ASTM/ISO Testing	Speed m/s (ft/min)
AWC630 Unfilled PEEK®	25 to 152 (1 to 6)	-45 to 175 (-50 to 350)	20,000 ASTM D695	1 (200)
AWC635 Glass-filled PEEK®	25 to 152 (1 to 6)	-45 to 175 (-50 to 350)	26,000 ASTM D695	1 (200)
AWC650 Acetal (POM)	25 to 381 (1 to 15)	-31 to 73 (-25 to 165)	8,000 ASTM D695	1 (200)
AWC665 Nylon with MoS <sub>2</sub>	381 to 914 (15 to 36)	-40 to 105 (-40 to 212)	14,000 ISO 604	1 (200)

\*Other materials are available upon request. PEEK® is a trademark of Victrex plc.

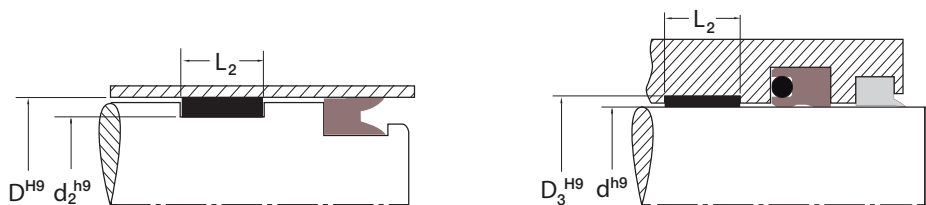

**PRODUCT PROFILES:**



**To place an order:**

Product profile: \_\_\_\_\_  
 Material: \_\_\_\_\_  
 Rod or ram diameter (d): \_\_\_\_\_  
 Groove diameter (D<sub>3</sub>): \_\_\_\_\_  
 Groove height (L<sub>2</sub>): \_\_\_\_\_

**To place an order:**

Product profile: \_\_\_\_\_  
 Material: \_\_\_\_\_  
 Groove diameter (d<sub>2</sub>): \_\_\_\_\_  
 Cylinder bore diameter (D): \_\_\_\_\_  
 Groove height (L<sub>2</sub>): \_\_\_\_\_

# ROTARY S

INNOVATIVE, DIFFERENTIATED PRODUCTS



## Bearing and Gearbox Protection

*Innovative designs*

Chesterton offers a complete line of rotary products specifically designed for bearing and gearbox protection. This includes our patent pending, split 33K technology which eliminates the need for equipment disassembly.

- FAST
- EASY
- RELIABLE

## Spring Energized Seals

*Advanced polymeric seals for demanding environments*

Chesterton spring energized seals are the latest version of advanced polymeric seals available to industry. These products perform in a wide variety of applications where conventional polymer seals underperform due to excessive speed, chemical attack, or extreme temperatures.

- Precision machined seals
- High speed capabilities
- Unparalleled chemical compatibility
- Extreme pressure capability
- Unlimited size range





# EALS

## Restrictor Bushings

*Robust designs for rotary equipment*

Chesterton restrictor bushings are designed for use in rotary equipment to form a barrier between the sealing device in the stuffing box, or the pump impeller housing, and the fluid in the mixing tank. These bushings reduce flush requirements, prevent system contamination, and extend packing and seal life.

- Reduce flush requirements
- Extend packing and seal life



## State-of-the-Art Materials

*For the most challenging applications*

Chesterton selects the right material for your specific application requirements. These advanced materials have been proven to withstand extreme pressure and temperature ranges, including the most challenging applications.

- Fluoroplastics
- Engineered plastics
- Elastomers

## Custom Polymer Seals

*Low speed, rotary applications*

Chesterton offers a wide range of products specifically designed for low speed rotary applications. Using our thermoset polyurethane materials, our engineers are able to custom design a seal to meet your specific needs.

- Durable polymer-based rotary seals
- Maximum performance and proven reliability







# ROTARY AND SPRING ENERGIZED SEALS

*A.W. Chesterton Company is a worldwide manufacturer and distributor of the highest performing sealing devices. A combination of our unique products, the support of local field specialists, and the expertise of our engineering staff will enable you to enjoy increased reliability and years of trouble-free service.*

*This section includes specific information pertaining to rotary and spring energized products offered by Chesterton.*

## **Section II**

- Rotary Seals
- Spring Energized Seals

# 30K Bearing and Gearbox Protection

*Advanced lip seal for bearing and gearbox protection*

Chesterton® 30K lip seals are high performance lip seals that are ideal for dynamic rotary seal applications. These seals prevent penetration of external contaminants from entering the housing and provide excellent service in bearing and gear box applications that utilize conventional oil lip seals.

The 30K is manufactured individually, using our unique machining process, which eliminates the need for tooling costs associated with new sizes. The 30K is offered in other unique designs based on your application requirements—whether a built-in wiper is required or space limited.

The unique 30K lip seal design is mechanically formed to provide optimal sealing force and is available in four distinct PTFE materials developed specifically for sealing applications. The PTFE compounds, coupled with the seal design, provide excellent fluid compatibility and outstanding performance.

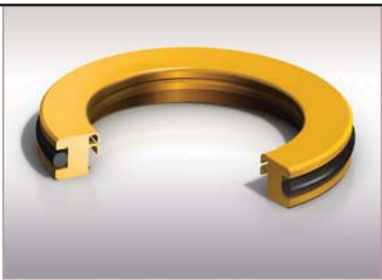

- High performance lip seals prevent contaminants from entering housing
- Mechanically formed designs provide optimal sealing force to extend MTBR
- Machining process allows the flexibility to create any size without tooling cost
- Static O-ring seal prevents rotation and allows for easy installation
- Unique materials ensure plant-wide usage

SPECIFICATIONS						
Material (combination) (adapters/sealer rings)	Size Range mm (inch)	Temperature °C (°F)	Speed m/s (ft/min)	Pressure bar (psi)	Recommended use	Mating surface (Rockwell C)
AWC100 (PTFE) Polyimide	20 to 150 (0.787 to 6)	-30 to 149 (-20 to 300)	Up to 20 (4000)	0.7 (10)	Excellent dry Excellent low viscosity No water and steam	≥45
AWC300 (PTFE) Molybdenum & glass					Excellent high viscosity Good dry and good in water	≥55
AWC400 (PTFE) Carbon & graphite					Excellent in water Good dry and low viscosity	≥55
AWC510 (PTFE) Mineral (FDA listed)					Excellent dry Good in water and steam No petroleum liquids	≥45

Performance depends on concurrent conditions including shaft hardness, shaft surface roughness, material, lubrication, temperature and pressure.

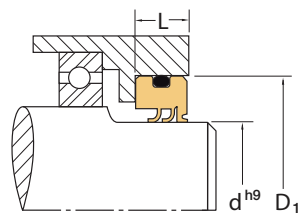

### PRODUCT PROFILES:



**To place an order:**  
 Product profile: \_\_\_\_\_  
 Material: \_\_\_\_\_  
 Rod shaft diameter (d): \_\_\_\_\_  
 Bore diameter (D<sub>1</sub>): \_\_\_\_\_  
 Groove height (L): \_\_\_\_\_

# 33K Bearing and Gearbox Protection

*Unitized split seal for bearing and gearbox protection*

The Chesterton® patent pending 33K split design eliminates the need and associated costs for equipment disassembly while improving seal performance of conventional lip seals. This innovative split technology, prevents penetration of external contaminants from entering the housing to provide excellent service in bearing and gear box applications.

The 33K is manufactured using our unique machining process that eliminates the need for tooling costs associated with new sizes. The seal can be installed in either direction which allows the end user to locate sealer rings away from a previously damaged shaft.

The seal is a combination of two different material types. The unitized housing is made from abrasion-resistant thermoset polyurethane that energizes and provides easy mounting to the equipment. The sealing interface is made from high performance, filled PTFE material developed specifically for sealing applications.

**SPECIFICATIONS**



Material (adapters/sealer rings)	Size Range mm (inch)	Temperature °C (°F)	Speed m/s (ft/min)	Pressure bar (psi)	Recommended use	Mating surface (Rockwell C)
-------------------------------------	-------------------------	------------------------	-----------------------	-----------------------	-----------------	-----------------------------------

**AWC800 Adapters (EU)**

AWC100 (PTFE) Polyimide	25 to 610 (1 to 24)	85 (185)	12,7 (2,500)	0.07 (1)	Excellent dry Excellent low viscosity	≥45
AWC300 (PTFE) Moly and glass	25 to 610 (1 to 24)	85 (185)	12,7 (2,500)	0.07 (1)	Excellent high viscosity Good dry and good in water	≥55
AWC400 (PTFE) Carbon & graphite	25 to 610 (1 to 24)	85 (185)	12,7 (2,500)	0.07 (1)	Excellent in water Good dry and low viscosity	≥55

**AWC860 Adapters (EU)**

AWC100 (PTFE) Polyimide	25 to 457 (1 to 18)	121 (250)	12,7 (2,500)	0.07 (1)	Excellent dry Excellent low viscosity	≥45
AWC300 (PTFE) Moly and glass	25 to 457 (1 to 18)	121 (250)	12,7 (2,500)	0.07 (1)	Excellent high viscosity Good dry and good in water	≥55
AWC400 (PTFE) Carbon & graphite	25 to 457 (1 to 18)	121 (250)	12,7 (2,500)	0.07 (1)	Excellent in water Good dry and low viscosity	≥55

Performance depends on concurrent conditions including shaft hardness, shaft surface roughness, material, lubrication, temperature, and pressure.

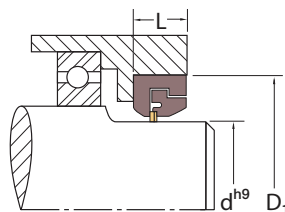

**PRODUCT PROFILES:**



33K

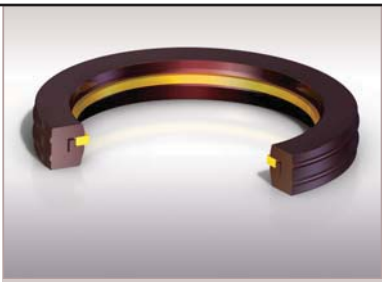

**FAST**

*Split design eliminates the need for equipment disassembly*

**EASY**

*Unitized design provides easy mounting to the equipment*

**RELIABLE**

*Proven to outperform conventional lip seals*

■ *Flexible design, locate sealer rings away from previously fretted shaft*

■ *Large sizes available, cost effective solution to equipment teardown*

**To place an order:**

Product profile: \_\_\_\_\_

Material: \_\_\_\_\_

Rod shaft diameter (d): \_\_\_\_\_

Bore diameter (D<sub>1</sub>): \_\_\_\_\_

Groove height (L): \_\_\_\_\_

# 30KC Viscous Fluids and Powders

Cartridge design for sealing powders and viscous fluids

Chesterton® 30KC polymer cartridge seals are designed for use in dynamic rotary seal applications. This cartridge design uses high performance, filled PTFE materials proven to withstand the high shear rates, frictional heat, and abrasives common when pumping high viscosity products and powders.

The 30KC high performance, filled PTFE compounds are coupled with the unique seal design to provide excellent fluid compatibility and outstanding performance. All engineered cartridges are custom manufactured to equipment dimensions eliminating the need for equipment modifications.

The 30KC is designed with an inboard sealing element, an outboard sealing element, and built-in flushing ports. The inboard lip seals process fluid, the outboard lips seal barrier fluid, while the flush port allows for flushing. The versatile cartridge design is extremely tough and able to withstand adhesion between the sealing surfaces and shaft due to reacted material and dry running capabilities.

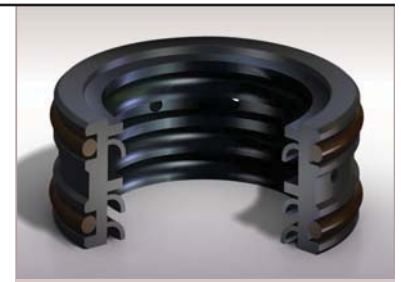

- *Outperform conventional packing, sealing high viscosity fluids and dry powders*
- *Decrease downtime, easy-to-install versatile cartridge design*
- *Improve performance of compression packing, distinct PTFE materials*
- *Custom designed cartridges made to equipment dimensions*

SPECIFICATIONS							
*Material (combination) (adapters/sealer rings)	Shaft Size mm (inch)	Temperature °C (°F)	Speed m/s (ft/min)	Pressure bar (psi)	Mating surface (Rockwell C)	Surface finish µm (µ inch)	**Recommended use
AWC100 (PTFE) Polyimide	25 to 200 (1.000 to 7.875)	- 30 to 150 (-20 to 300)	Up to 5 (984)	to 10 (150)	45	Dynamic 0.2 to 0.4 (8 to 16)	<b>Excellent dry</b> Excellent low viscosity (<2,000 cp) Powders, oil, resins, glues, paints No water or steam
AWC300 (PTFE) Molybdenum & glass					55		<b>Excellent high viscosity</b> (>2,000 cp) Good in dry, water or steam
AWC400 (PTFE) Carbon & graphite					55		<b>Excellent in water or steam</b> Good dry and low viscosity Powders, asphalt, clay, slurries
AWC510 Mineral (FDA listed)					45		<b>Excellent dry</b> Good in water or steam Chocolate and syrups No petroleum liquids

\* fluor elastomer O-rings provided (FDA listed w/AWC510) \*\* runout to 0,15mm (.005")

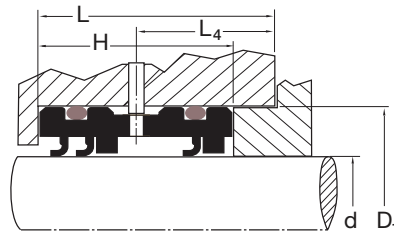

**PRODUCT PROFILES:**



30KC

**To place an order:**  
 Product profile: \_\_\_\_\_  
 Material: \_\_\_\_\_  
 Rod shaft diameter (d): \_\_\_\_\_  
 Stuffing bore diameter (D<sub>1</sub>): \_\_\_\_\_  
 Groove height (L): \_\_\_\_\_  
 Distance to flush port(L<sub>4</sub>): \_\_\_\_\_  
 Cartridge height(H): \_\_\_\_\_

# 14K Restriction Bushings

*Robust, restriction bushing for rotary equipment*

Chesterton® 14K restriction bushings are designed for use in rotary equipment to form a barrier between the sealing device in the stuffing box or the pump impeller housing and the fluid in the mixing tank. The restriction that is produced reduces flush requirements and helps to prevent suspended abrasive particles from entering the stuffing box area.

The 14K restriction bushings are manufactured using a machining process which allows the flexibility to create any size, based on equipment dimensions. Each bushing is individually manufactured and provides excellent performance in pumps, agitators, mixers, refiners, and other equipment.

The 14K's tapered lip design conforms to equipment eccentricities to minimize the annular gap formed around the rotating shafts, thereby creating the smallest possible free flow area for controlling flush flow rates. A secondary beneficial effect of increasing pressure drop with the 14K is that the flush around the shaft becomes very uniform, which is critical in preventing particulates from entering the stuffing box envelope.

SPECIFICATIONS			
Material (designation)	Size Range mm (inch)	Temperature °C (°F)	pH range
AWC520 (PTFE)	25 to 355 (1 to 14)	Up to 200 (400)	0-14
AWC800 (EU)	25 to 355 (1 to 14)	Up to 85 (185)	4-10

**Flow rates — approximated for water by the following formulas**

Flow rate, liter/min =  $([0.115 \times \Delta \text{ pressure, bar}] + [0.064]) \times \text{shaft diameter, mm}$   
 Flow rate, gallon/min =  $([0.053 \times \Delta \text{ pressure, psi}] + [0.43]) \times \text{shaft diameter, inch}$

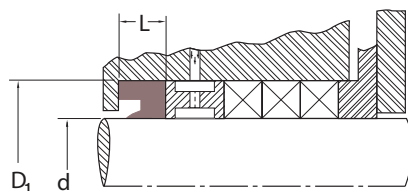

**PRODUCT PROFILES:**

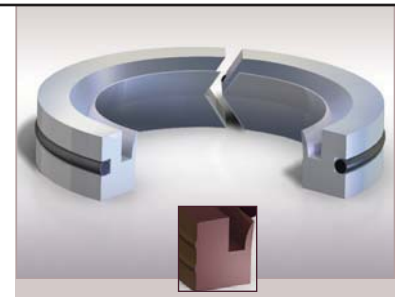

- Split design, simplifies installation
- Prevents particles from entering the stuffing box, extending packing and seal life
- Tapered lip design controls fluid bypass and helps increase pumps efficiency
- Dual materials available, plant-wide usage
- Designed for pumps of all types including agitators, mixers, and refiners

**To place an order:**  
 Product profile: \_\_\_\_\_  
 Material: \_\_\_\_\_  
 Rod shaft diameter (d): \_\_\_\_\_  
 Bore diameter (D<sub>1</sub>): \_\_\_\_\_  
 Groove height (L): \_\_\_\_\_

# 100 Series - Cantilever Spring Design

*Cantilever spring energized seals, highly dynamic applications*

Cantilever spring energized seals are primarily used in highly dynamic applications for rotary and reciprocating equipment because the spring design allows for high deflection with minimal loading. This is the most popular series for spring energized seal designs due to its unique attributes, which help to maximize seal and hardware life.

The 100 Series is available in three unique jacket materials to address a broad range of applications. Each seal jacket is used in combination with a high performance, stainless steel cantilever spring to ensure that positive sealing force is applied to the mating surface.

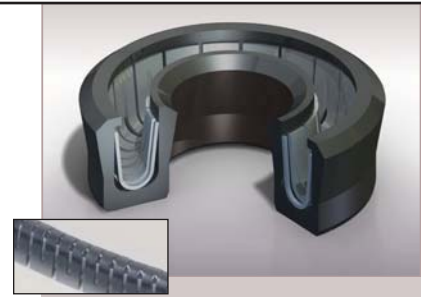

- *Highly dynamic applications, plant-wide usage*
- *Unidirectional designs, available as rod, piston, flange or static seals*
- *Single point profile yields high sealability while minimizing frictional force*
- *All seals made to order, no equipment modifications required*
- *Custom designs and materials available upon request*

SPECIFICATIONS		
Material (designation)	Size Range mm (inch)	Temperature °C (°F)
AWC400 (PTFE) Carbon & graphite	1.2 to 2,032 (0.050 to 80)	-156 to 204 (-250 to 400)
AWC630 PEEK®	1.2 to 254 (0.050 to 10)	-73 to 204 (-100 to 400)
AWC610 UHMWPE	1.2 to 2,032 (0.050 to 80+)	-253 to 82 (-425 to 180)

PEEK® is a trademark of Victrex plc.

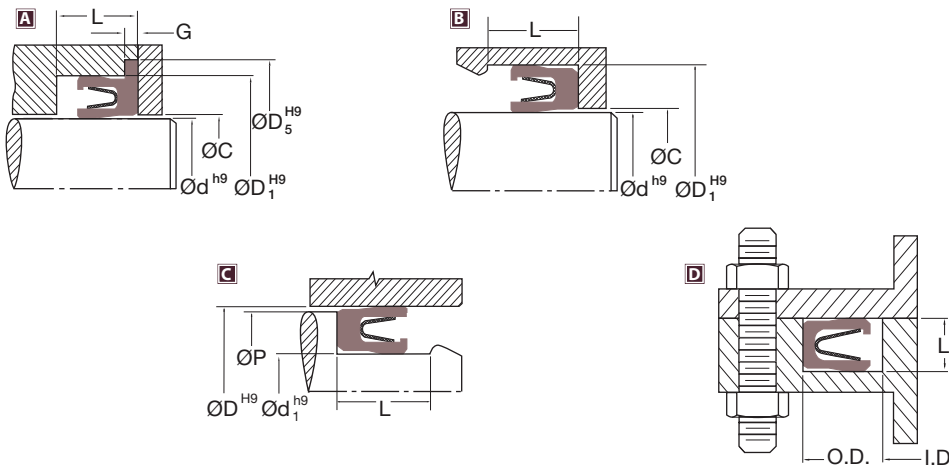

**PRODUCT PROFILES:**



**To place an order:** A

Product profile: \_\_\_\_\_

Material: \_\_\_\_\_

Rod shaft diameter (d): \_\_\_\_\_

Bore diameter (D<sub>1</sub>): \_\_\_\_\_

Flange groove depth (G): \_\_\_\_\_

---

**To place an order:** B

Product profile: \_\_\_\_\_

Material: \_\_\_\_\_

Rod shaft diameter (d): \_\_\_\_\_

Bore diameter (D<sub>1</sub>): \_\_\_\_\_

Groove height (L): \_\_\_\_\_

---

**To place an order:** C

Product profile: \_\_\_\_\_

Material: \_\_\_\_\_

Piston groove diameter (d<sub>1</sub>): \_\_\_\_\_

Bore diameter (D): \_\_\_\_\_

Groove height (L): \_\_\_\_\_

---

**To place an order:** D

Product profile: \_\_\_\_\_

Inner diameter (I.D.): \_\_\_\_\_

Outer diameter (O.D.): \_\_\_\_\_

Groove height (L): \_\_\_\_\_



# 200 Series - Elliptical Coil Spring Design

*Elliptical coil spring energized seals, accommodate excessive tolerances or misalignment*

Elliptical coil spring energized seals are commonly used in rotary, reciprocating, and static applications where hardware tolerances are relatively large or where a miniature seal is required. Elliptical coil spring designs allows for minimal deflection while applying intermediate loads.

The 200 Series is available in three unique jacket materials to address a broad range of applications. Each seal jacket is used in combination with a high performance, stainless steel elliptical coil spring to ensure that positive sealing force is applied to the mating surface.

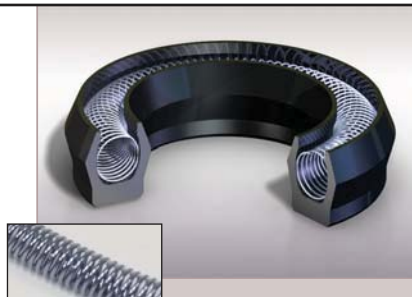

- *Unidirectional design accommodates excessive tolerances or misalignment*
- *Elliptical coil spring design, high load vs. deflection*
- *Miniature profiles accommodate small diameters*
- *All seals made to order, no equipment modifications required*
- *Custom designs and materials available upon request*

SPECIFICATIONS		
Material (designation)	Size Range mm (inch)	Temperature °C (°F)
AWC400 (PTFE) Carbon & graphite	1.2 to 2,032 (0.050 to 80)	-156 to 204 (-250 to 400)
AWC630 PEEK®	1.2 to 254 (0.050 to 10)	-73 to 204 (-100 to 400)
AWC610 UHMWPE	1.2 to 2,032 (0.050 to 80+)	-253 to 82 (-425 to 180)

PEEK® is a trademark of Victrex plc.

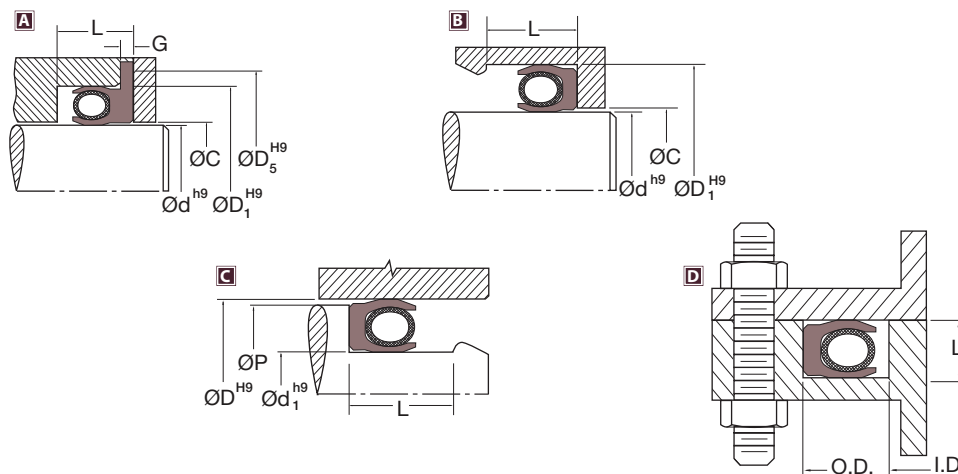

**PRODUCT PROFILES:**



**To place an order:** A  
 Product profile: \_\_\_\_\_  
 Material: \_\_\_\_\_  
 Rod shaft diameter (d): \_\_\_\_\_  
 Bore diameter (D<sub>1</sub>): \_\_\_\_\_  
 Flange groove depth (G): \_\_\_\_\_

**To place an order:** B  
 Product profile: \_\_\_\_\_  
 Material: \_\_\_\_\_  
 Rod shaft diameter (d): \_\_\_\_\_  
 Bore diameter (D<sub>1</sub>): \_\_\_\_\_  
 Groove height (L): \_\_\_\_\_

**To place an order:** C  
 Product profile: \_\_\_\_\_  
 Material: \_\_\_\_\_  
 Piston groove diameter (d<sub>1</sub>): \_\_\_\_\_  
 Bore diameter (D): \_\_\_\_\_  
 Groove height (L): \_\_\_\_\_

**To place an order:** D  
 Product profile: \_\_\_\_\_  
 Inner diameter (I.D.): \_\_\_\_\_  
 Outer diameter (O.D.): \_\_\_\_\_  
 Groove height (L): \_\_\_\_\_

# 300 Series - Helical Wound Spring Design

*Helical wound spring energized seals for slow speed and static applications*

Helical wound spring energized seals are primarily used in static applications, slow speeds, extremely low temperatures, and/or infrequent dynamic conditions when friction and wear are secondary concerns. The spring design has excellent loading capabilities with minimal deflection.

The 300 Series is available in three unique jacket materials to address a broad range of applications. Each seal jacket is used in combination with a high performance, stainless steel elliptical coil spring to ensure that positive sealing force is applied to the mating surface.

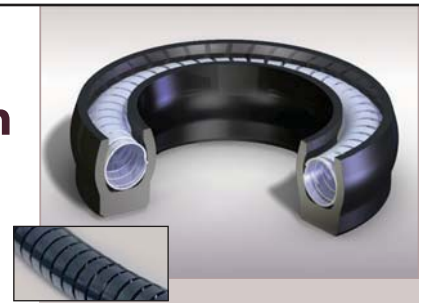

- *Unidirectional design for slow speed and static applications*
- *Helical wound spring design, high load, minimal deflection*
- *Concentrated load design when friction and wear are secondary concerns*
- *All seals made to order, no equipment modifications required*
- *Custom designs and materials available upon request*

SPECIFICATIONS		
Material (designation)	Size Range mm (inch)	up to Temperature °C (°F)
AWC400 (PTFE) Carbon & graphite	1.2 to 2,032 (0.050 to 80)	-156 to 204 (-250 to 400)
AWC630 PEEK®	1.2 to 254 (0.050 to 10)	-73 to 204 (-100 to 400)
AWC610 UHMWPE	1.2 to 2,032 (0.050 to 80+)	-253 to 82 (-425 to 180)

PEEK® is a trademark of Victrex plc.

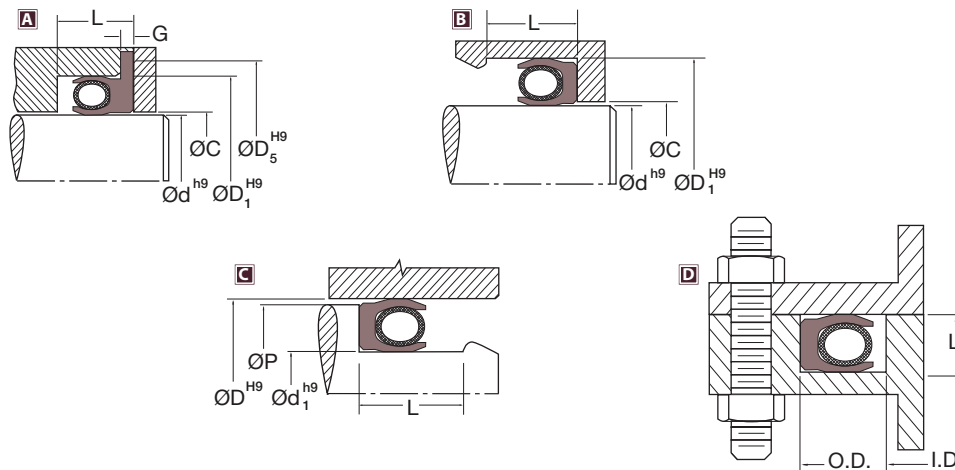

**PRODUCT PROFILES:**



**To place an order:** A  
 Product profile: \_\_\_\_\_  
 Material: \_\_\_\_\_  
 Rod shaft diameter (d): \_\_\_\_\_  
 Bore diameter (D<sub>1</sub>): \_\_\_\_\_  
 Flange groove depth (G): \_\_\_\_\_

**To place an order:** B  
 Product profile: \_\_\_\_\_  
 Material: \_\_\_\_\_  
 Rod shaft diameter (d): \_\_\_\_\_  
 Bore diameter (D<sub>1</sub>): \_\_\_\_\_  
 Groove height (L): \_\_\_\_\_

**To place an order:** C  
 Product profile: \_\_\_\_\_  
 Material: \_\_\_\_\_  
 Piston groove diameter (d<sub>1</sub>): \_\_\_\_\_  
 Bore diameter (D): \_\_\_\_\_  
 Groove height (L): \_\_\_\_\_

**To place an order:** D  
 Product profile: \_\_\_\_\_  
 Inner diameter (I.D.): \_\_\_\_\_  
 Outer diameter (O.D.): \_\_\_\_\_  
 Groove height (L): \_\_\_\_\_

# 400 Series - Rotary Seals

*High performance, multi-purpose rotary seals*

Chesterton® 400 Series high performance, multi-purpose rotary seals are designed for use in dynamic applications. The unique seal lip design is mechanically formed to provide optimal sealing force. The materials are coupled with an exceptional seal design to provide excellent fluid compatibility and outstanding performance.

The 400 Series is available in three unique jacket materials to address a broad range of applications. Some designs incorporate springs for increased loading capabilities or support.

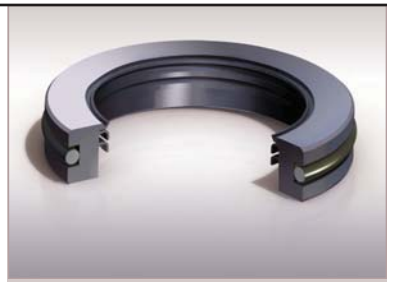

- *Unidirectional design specifically design for high speed rotary applications*
- *Multi-purpose rotary lip seals, plant-wide usage*
- *All seals made to order, no equipment modifications required*
- *Custom profiles available*

**SPECIFICATIONS**



Material (designation)	Size Range mm (inch)	Temperature °C (°F)
AWC400 (PTFE) Carbon & graphite	1.2 to 2,032 (0.050 to 80)	-156 to 204 (-250 to 400)
AWC610 UHMWPE	1.2 to 2,032 (0.050 to 80+)	-253 to 82 (-425 to 180)

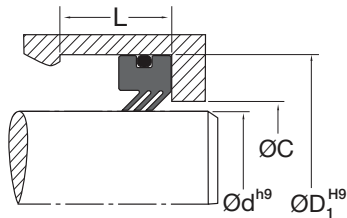

**PRODUCT PROFILES:**



EPS411



EPS414

**To place an order:**

Product profile: \_\_\_\_\_  
 Material: \_\_\_\_\_  
 Rod shaft diameter (d): \_\_\_\_\_  
 Bore diameter (D<sub>1</sub>): \_\_\_\_\_  
 Groove height (L): \_\_\_\_\_

# 500 Series - Stacked V-ring Seals

High performance, multi-purpose V-rings

High performance, multi-purpose stacked V-ring sets specifically designed to accommodate hardware with deep stuffing boxes. These stacked sets are used in both rotary and reciprocating applications and are available in solid and spilt designs, depending upon your application requirements.

The 500 Series is available in three unique jacket materials to address a broad range of applications. Some designs incorporate the use of a stainless steel spring or support ring for increased load or stability.

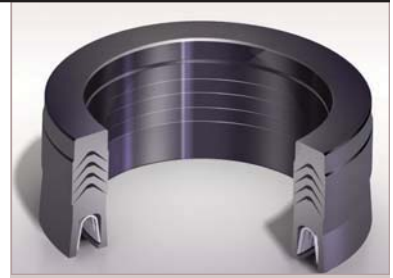

- Unidirectional design specifically designed to replace V-rings sets
- Multi-purpose V-ring seal sets, plant-wide usage
- All seals made to order, no equipment modifications required
- Custom profiles available
- V-ring sets accommodate hardware with deep stuffing boxes

SPECIFICATIONS		
Material (designation)	Size Range mm (inch)	Temperature °C (°F)
AWC400 (PTFE) Carbon & graphite	1.2 to 2,032 (0.050 to 80)	-156 to 204 (-250 to 400)
AWC630 PEEK®	1.2 to 254 (0.050 to 10)	-73 to 204 (-100 to 400)
AWC610 UHMWPE	1.2 to 2,032 (0.050 to 80+)	-253 to 82 (-425 to 180)

PEEK® is a trademark of Victrex plc.

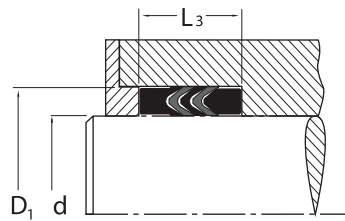

PRODUCT PROFILES:



EPS500    EPS520    EPS521    EPS540

To place an order:

Product profile: \_\_\_\_\_  
 Material: \_\_\_\_\_  
 Rod shaft diameter (d): \_\_\_\_\_  
 Bore diameter (D<sub>1</sub>): \_\_\_\_\_  
 Working height (L<sub>3</sub>): \_\_\_\_\_



# ENGINEER

## TECHNICAL GUIDELINES



### Product Profiles and Descriptions

Choosing the appropriate design for your application will help to maximize seal performance. The product profile reference chart provides the user with a basic guideline for each profile designation and its recommended usage. These profiles coincide with the profiles available through our SpeedSeal® Program.

- Hydraulic and pneumatic seals
- Rotary and spring energized seals

### Design Guidelines

Designing your hardware to international standards will help to ensure that maximum seal performance is realized. Chesterton products are used in a wide array of applications including hydraulic, pneumatic, rotary, reciprocating, oscillating and static applications. Based on years of experience, our designs have been developed to maximize seal performance based on the guidelines provided.

- Hardware guidelines
- ISO fits and tolerances

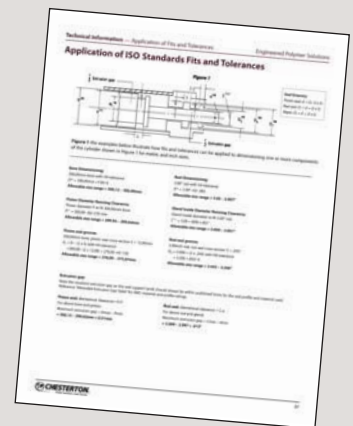

### Materials Matrix

Choosing the proper material to coincide with the seal design of choice provides the best opportunity to maximize seal performance. Chesterton has an extensive materials portfolio that includes in excess of 60 products many of which are custom blended to accommodate specific end user requirements. This section highlights our most popular materials and is supported by pertinent specifications for polymer seals.

- General usage
- Properties

# ING

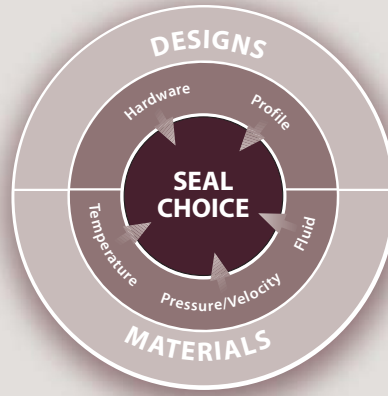

## Chemical Compatibility

Chesterton products are used in a wide range of hydraulic, pneumatic, and rotary equipment. Since fluid can vary drastically by application, the proper choice of a seal material can have a major impact on seal performance. The chemical compatibility reference chart provides a guideline for identifying an appropriate material for your application.

- Fluid listing
- Materials guideline

## Troubleshooting Guide

This guide is provided for use as a reference when repacking, rebuilding, or redesigning any cylinder or press. Based on real life experience, this section offers pictures and examples for recommended sealing solutions. The key to improving performance in future applications is to understand how and why seals fail prematurely.

- Probable causes
- Possible solutions

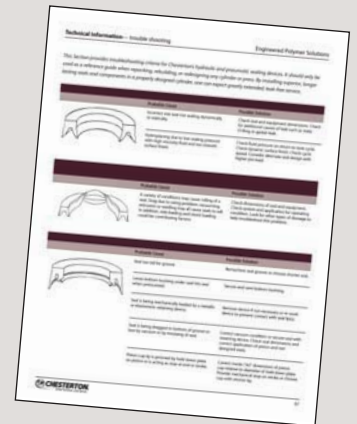

## Engineering Action Request Form

The Chesterton Engineering Action Request form is utilized to capture all the pertinent details regarding a specific application. With this information in hand, our technical support team, field specialists and engineers, are able to better understand your application and assess the various options available to you.

- Application details
- Hardware dimensions

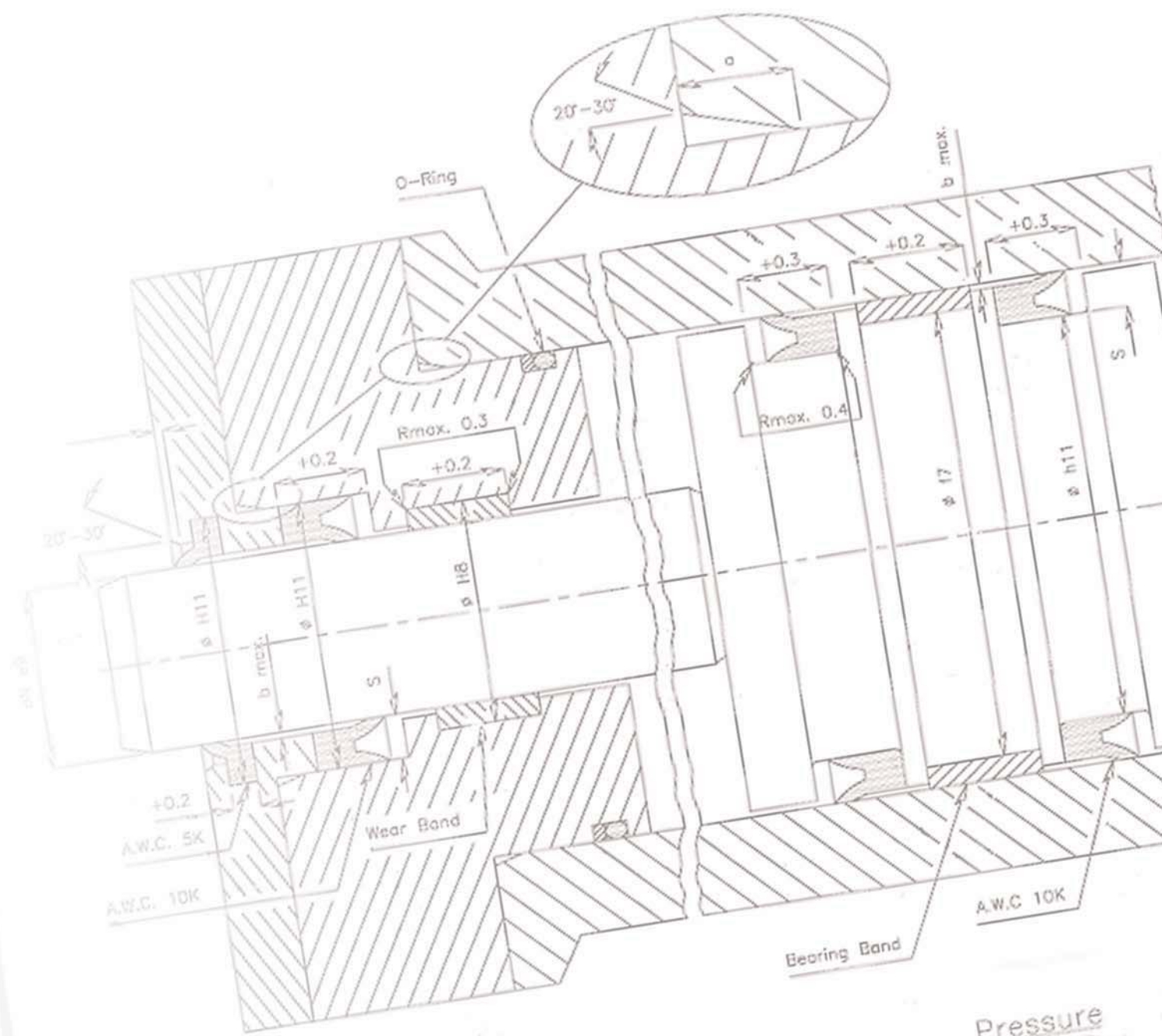

Pressure  
 < 200 Bar  
 < 400 Bar

Surface Finishes:  
 Dynamic:  $R_a=0,4 \mu m$  [16  $\mu inch$ ]  
 Static:  $R_a=1,0 \mu m$  [40  $\mu inch$ ]

- UNLESS OTHERWISE SPECIFIED
1. DIMENSIONS ARE IN MILLIMETERS
  2. TOLERANCES ON DIMENSIONS
  3. SURFACE ROUGHNESS
  4. REMOVE BURRS AND DEBURR
  5. MACHINED FILLET
  6. MACHINED DIAS OF CONCENTRIC HOLES
  7. NORMALITY SQUARE
  8. MACHINED SURFACE



S	a
4,0	2,0
5,0	2,5
7,5	4,0
10,0	5,0
12,5	6,5
15,0	7,5
20,0	10,0



b max.  
0,8  
0,4

SPECIFIED	DRAWN
INCHES	DATE 5-8
± .01 FRACTIONS ± 1/64	CHECKED
± .005 ANGLES = 1/2°	DATE 5
FINISH ON SURFACES	APP'D
AND SHARP EDGES TO .010	DATE
SMALLEST RADIUS .010 MAX.	SCALE N.
ON A COMMON CENTERLINE	
WITHIN .003 TYP.	
PERPENDICULARITY AND PARALLELISM	
SURFACES .002 PER INCH TO	
UNLESS OTHERWISE SPECIFIED	

# ENGINEERING GUIDELINES

*A.W. Chesterton Company is a worldwide manufacturer and distributor of the highest performing sealing devices. A combination of our unique products, the support of local field specialists and the expertise of our engineering staff will enable you to enjoy increased reliability and years of trouble free service.*

*This section includes engineering guidelines in support of the products offered by Chesterton.*

## Section III

- Product Profiles and Descriptions
- Design Guidelines
- Materials Matrix
- Fluid Compatibility
- Troubleshooting Guide
- Engineering Action Request Form

# Engineering Introduction

Determining the appropriate sealing device for a particular application is generally determined by operating parameters, such as pressure, speed, temperature, fluid compatibility requirements, available envelope, performance life, allowable leakage, and cost. In many instances particular sealing devices are utilized in certain applications due largely to legacy. That is, the prior and repeated use of a sealing device over many years in an application.

A sealing device can be broadly defined as a product that controls and, therefore, prevents the movement of fluid between adjacent locals within equipment or to the environment. At the basic level seals can be characterized as either *contacting* or *non-contacting*. Non-contacting seals are specified in applications where pressure differentials are not present and life is limitless due to the lack of a dynamic sealing interface.

The more prevalent sealing products address the interface between two equipment surfaces to create a positive seal. These seals can be placed in two categories: *static* and *dynamic*. Even though the term implies otherwise, a static seal generally does involve some very small movements. Examples include the expansion and contraction of equipment or pressure cycling within the system influencing the seal itself. Static seals represent the largest population of sealing devices: O-rings, gaskets, sealing compounds, and metal seals. Dynamic sealing is the more challenging of the two categories. Dynamic sealing applications are configurations where system components experience relatively high speed reciprocating or rotary motion. Such situations have more operating parameters to be considered in order to provide a suitable sealing solution.

The major categories of dynamic sealing devices include mechanical packing, mechanical seals, and polymer based seals. Among the several parameters that are used to determine the appropriate type of material and seal design utilization are *wear* and *pressure-velocity (P-V)* characteristics.

The chart indicates the wear characteristics of some of the major material groups used in polymer sealing. The lower values indicate better wear characteristics or longer life with respect to interfacing metallic surfaces. As an example, polyurethane-based materials have better wear characteristics than PTFE.

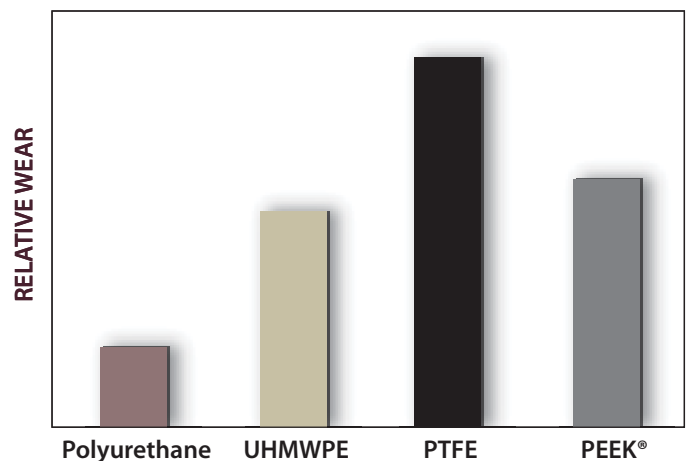

Although this chart provides some insight into the relative wear characteristics, the materials have limits to the level of pressure and velocity each material can withstand for suitable service.

A factor expressed as the product of pressure and velocity provides a reference value for the level at which materials and seal designs can practically endure. Such values relate to equipment operating parameters. It is convenient to integrate both material and seal design configuration to look at which provides appropriate performance. The chart below provides some general ranges by seal type relating to pressure and velocity.

In the case of polyurethane, the material is generally used without external loading (e.g., springs) due to its unique characteristics, which allow it to return to its original shape. As indicated on the chart, polyurethane materials are generally recommended for use at lower speeds and higher pressures.

Rotary seals are generally not loaded with springs and typically utilize various PTFE compounds. Rotary seals can be used at higher surface velocities with lower pressures.

Spring energized seals, used in both rotary and reciprocating applications, cover a very broad range of pressure and velocity characteristics. These include various spring types (i.e., cantilever, helical and elliptical) and materials used to satisfy the equipment operating parameters. Spring energized seals can be used at relatively high pressures or surface velocities.

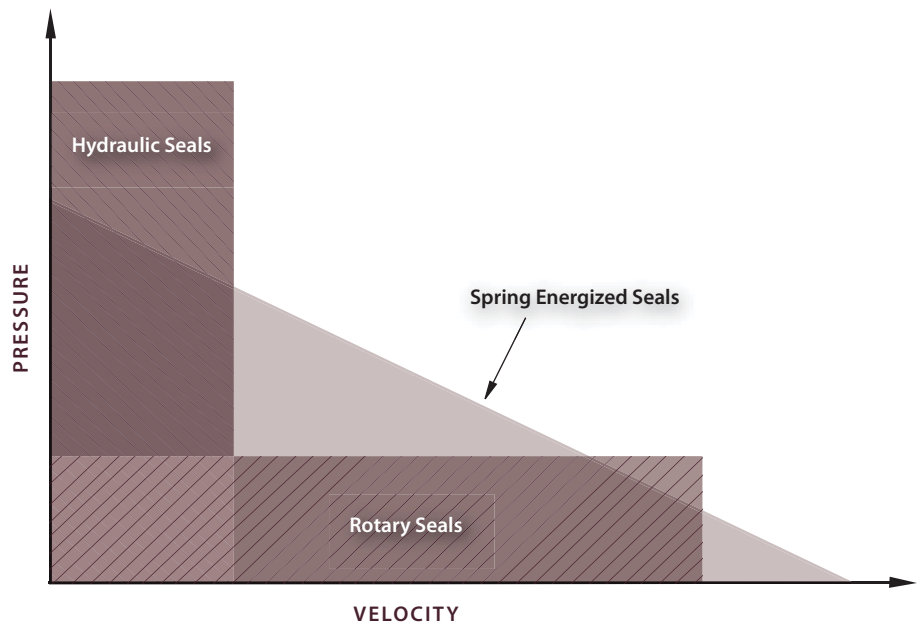

PEEK® is a trademark of Victrex plc.

# Wipers

The function of a wiper is to effectively clean and dislodge foreign matter from a reciprocating rod/ram to prevent contaminants from entering the system.

## 5K/21K STANDARD WIPER

Positive rake wiper designed to effectively clean and dislodge foreign matter from retracting rod/ram to prevent scoring and system contamination.

Profile	Description
W5K	Molded wiper with flange design
W21KF	Machined wiper with flange design
W21KT5	Machined wiper to accommodate taller grooves heights while providing added stability
W21K	Machined wiper with static bump flange design to eliminate migration of contaminants
W21KC	Machined combination wiper and rod seal, pneumatic use only
W21KC1	Machined combination wiper and rod seal with static stabilizing bump, pneumatic use only
W21KCS	Machined combination wiper and rod seal designed with stepped flange, pneumatic only
W21KH	Machined wiper with flange design, for replacement as a hat seal
W21KM	Machined wiper designed with snap-in fit for specific equipment types
W21KR	Machined wiper with static flange bump and stabilizing heel
W21KS	Machined wiper profile for with stepped flange
WCCS	Machined wiper using an O-ring loader for use with PTFE compounds



## 5K/21K CANNED WIPERS

Positive rake canned wiper designed to effectively clean and dislodge foreign matter from retracting rod/ram to prevent scoring and system contamination. A canned wiper is a press-fit design for use in an open housing groove and does require an additional retaining device due to the interference fit.

Profile	Description
CW21K	Machined dual component, full canned stepped flange canned wiper design
CW21K1	Machined dual component, partial stepped flange canned wiper design
CW21K2	Machined dual component with taller static lip canned wiper design
CW21K3	Machined dual component, full canned wiper design

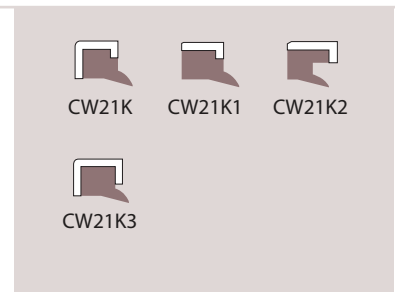

## Rod Seals – U-cups

The function of a rod seal is to prevent fluid bypass along the dynamic (e.g., rod /ram) and static (stuffing box bore) surface under various operating conditions. A U-cup design refers to a continuous seal ring with a profile similar to the letter u.

### 10K / 22KN U-CUPS

A continuous, single-acting, rod or piston seal U-cup design that wipes contaminants away from the mating surface while in operation. The positive rake, lip profile provides an optimal amount of radial sealing load with minimal frictional resistance. Designed for use in hydraulic or pneumatic applications.

Profile	Description
R10K	Molded rod seal design for use in hydraulic or pneumatic cylinders and presses
R22KN	Machined rod seal design for use in hydraulic or pneumatic cylinders and presses
R10K1	Molded rod seal design with a standoff ring for vacuuming situations
R22KN1	Machined rod seal design with a standoff ring for vacuuming situations
R22KN5	Machined rod seal design with taller static lip for added stability and to resist vacuuming



### 6K U-CUPS

Continuous, single-acting, U-cup design with a positive rake profile that wipes contaminants away for the mating surface while in operation. The rugged, rubber-based construction is ideal for older, worn hydraulic cylinders and presses since it conforms to surface irregularities to effectively control leakage.

Profile	Description
R6K	Molded rod seal design for use in older, worn equipment



### 22K U-CUPS

A continuous, single-acting, rod or piston hydraulic seal design with a special lip geometry that increases lip pre-load and provides zero leakage throughout the entire operating range. The sturdy, static lip stabilizes the seal to prevent rolling while the negative rake lip profile eases installation.

Profile	Description
R22K	Machined rod seal for hydraulic cylinders and presses
R22KAER	Machined rod seal that includes a partial, rectangular anti-extrusion ring for equipment exposed to excessive clearances and pressure spikes
R22KAER1	Machined rod seal that includes a custom anti-extrusion ring for equipment exposed to excessive clearances and pressure spikes



### 22KE U-CUPS

A continuous, single-acting, rod or piston design incorporates the use of an O-ring to increase pre-load capabilities to improve low pressure sealing capabilities and high shock load loads capabilities in hydraulic applications. The O-ring energizes the seal which increases the pre-load capabilities of the seal in the absence of system pressure.

Profile	Description
R22KE	Machined rod seal for hydraulic cylinders and presses
R22KEAER	Machined rod seal that includes a partial, rectangular anti-extrusion ring for equipment exposed to excessive clearances and pressure spikes
R22KEAER1	Machined rod seal that includes a partial, anti-extrusion ring for equipment exposed to excessive clearances and pressure spikes



### 23K U-CUPS

A continuous, single-acting, rod or piston design that incorporates a unique, dynamic lip geometry that provides the optimal sealing force required for pneumatic applications.

Profile	Description
R23K	Machined continuous rod seal design



## Rod Seals – Stacked Sets

Stacked V-ring seal designs are most commonly used to ensure ease of installation due to the split design although in some cases continuous designs are preferred. These V-ring sets incorporate sealer rings that are nested inside a female/top and a male/bottom adapter. The number of sealer rings used in a set is predicated upon system pressure. The male adapter is used to ensure alignment of the sealer rings while also helping to energize the set under system pressure. The female adapter is designed to ensure alignment and support of the set while helping to compensate for extrusion into large equipment clearances.

### 8K/27K STACKED SETS

The pressure activated rod and piston V-ring sets are designed for use in hydraulic applications. The single acting, positive rake profile contacts through the center of the set to ensure even loading, longer sealing life using minimal gland pressure. Most sets are available split or solid.

Profile	Description
R8K	Molded single acting symmetrical seal set, available split or solid
R27K	Machined single acting symmetrical seal set, available split or solid
R27K1	Machined single acting symmetrical seal set with custom adapters for large clearances
R28K	Machined single acting symmetrical seal set for replacement of typical industry sets
R28K1	Machined single acting symmetrical seal set with adapters made from engineered plastics for added support and extrusion resistance
R28K2	Custom machined single acting symmetrical seal set with male adapters made from engineered plastics for added support and extrusion resistance

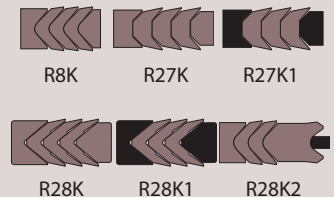

### 11K STACKED SETS

The single acting, two-piece stacked rod seal set employs a negative rake design to optimize operating performance while easing installation into the stuffing box cavity. The bottom ring is the primary sealer while the top ring works as an anti-extrusion ring, provides secondary sealing, and provides added support to the sealer ring. The set is available in various material combinations as well as split or solid designs.

Profile	Description
R11K	Molded or machined, symmetrical seal for hydraulic applications
R11KSPCR	Molded or machined, custom spacer used with seal set to help compensate for vacuuming, side loading conditions or shock loading conditions
R11KWSPCR	Molded or machined, single-acting two-piece stacked set with a custom designed spacer to help compensate for vacuuming conditions



### 600 STACKED SETS

Single acting, conventional compression stacked V-ring set that enables increased seal loading against sealing surfaces with increased gland pressure. While the rubber based material conforms to surface imperfections to control leakage. Set includes sealer rings and bottom adapter.

Profile	Description
R600	Molded single acting, conventional stacked design for older worn equipment, available split or solid



## Rod Seals – Compression/Static

Compression type seals are typically designed with a higher initial pre-load which helps to control leakage at low pressure. These profiles are typically designed for use in a single cavity groove but are able to seal pressure in both directions.

### RCCS ROD/COMPRESSION SEALS

Continuous, two-piece, bi-directional sealing system that uses an elastomer cap with an O-ring to create a very effective seal for single groove cavities in hydraulic applications. The cap is used as the dynamic sealing element while the O-ring energizes the cap and creates a static seal.

Profile	Description
RCCS	Machined two-piece, rod seal with an elliptical cap profile for more efficient loading in hydraulic applications
RCCS1	Machined two-piece, rod seal with a standard profile for use in hydraulic applications
RCCS2	Machined two-piece, rod seal with a rectangular loader for use in highly dynamic hydraulic applications
RCCS3	Machined two-piece, rod seal with a stepped cap profile for use in hydraulic applications
RCCS4	Machined two-piece, piston seal with a rectangular loader and a stepped cap profile for use in highly dynamic hydraulic applications

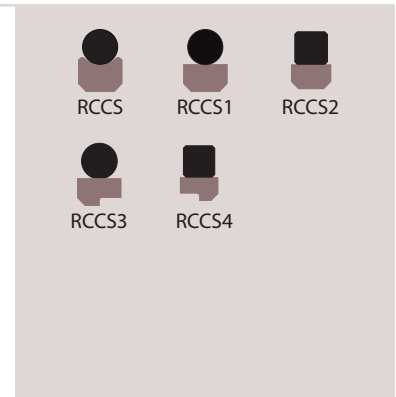

### 20K COMPRESSION

Continuous, bi-directional compression seal designed with dual independent sealing points. The heavy, durable dual lip design was specifically designed for single groove cavities in heavy duty, high pressure hydraulic applications. The seal design has the ability to withstand pressure spikes while helping to compensate for equipment side loading and maintain high unit loading.

Profile	Description
R20K1	Machined heavy duty rod seal for use in hydraulic applications
R20K2	Machined heavy duty rod seal with full anti-extrusion ring
R20K3	Machined heavy duty rod seal with partial anti-extrusion ring
R20KDAER	Machined heavy duty rod seal with two partial anti-extrusion rings

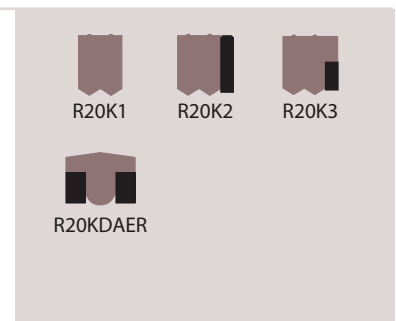

### 20KD STATIC/FACE

A continuous, high performance compression seal that is most commonly designed for use in static applications and is often applied as an upgrade from conventional O-rings. Designs are available for internal face sealing as well as external face sealing commonly found in single- or double-acting applications.

Profile	Description
R20KDR	Machined seal with a D profile with dynamic seal profile located on the inner diameter
20KDRFS	Machined profile for face sealing with the dynamic seal profile located on either the top or bottom
OR1	Machined seal for replacement of an O-ring
20KOR	Machined rectangular seal for sealing static connecting ports of standard hydraulic valves and control units
OR	Machined seal for replacement of a conventional O-ring

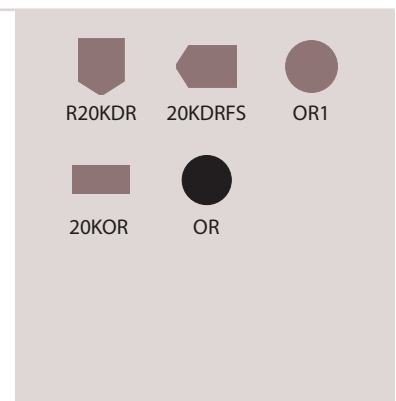

# Piston Seals – U-cups

The function of a piston seal is to prevent fluid bypass between the piston head and cylinder bore under various operating conditions.

## 10K/22KN U-CUPS

A continuous, single-acting, rod or piston seal, U-cup design that wipes contaminants away for the mating surface while in operation. The positive rake, lip profile provides an optimal amount of radial sealing load with minimal frictional load designed for use in hydraulic or pneumatic applications.

Profile	Description
P10K	Molded piston seal design for use in hydraulic or pneumatic cylinders and presses
P22KN	Machined piston seal design for use in hydraulic or pneumatic cylinders and presses
P10K1	Molded piston seal design with a standoff ring for vacuuming situations
P22KN1	Machined piston seal design with a standoff ring for vacuuming situations
P22KN5	Machined piston seal design with taller static lip for added stability and to resist vacuuming



## 22K U-CUPS

A continuous, single-acting, rod or piston hydraulic seal design with a special lip geometry that provides zero leakage throughout the entire operating range. The sturdy, static lip stabilizes the seal to prevent rolling while the negative rake lip profile eases installation.

Profile	Description
P22K	Machined piston seal for hydraulic cylinders and presses
P22KAER	Machined piston seal that includes a partial, rectangular anti-extrusion ring for equipment exposed to excessive clearances and pressure spikes
P22KAER1	Machined piston seal that includes a custom anti-extrusion ring for equipment exposed to excessive clearances and pressure spikes

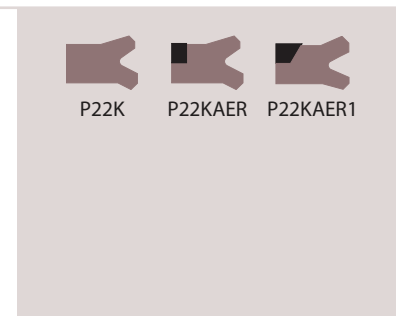

## 22KE U-CUPS

A continuous, single-acting, rod or piston design incorporates the use of an O-ring to increase pre-load capabilities for extreme low pressure sealing capabilities in hydraulic applications. The O-ring energizes the seal which increases the pre-load capabilities of the seal in the absence of system pressure.

Profile	Description
P22K	Machined piston seal for hydraulic cylinders and presses
P22KAER	Machined piston seal that includes a partial, rectangular anti-extrusion ring for equipment exposed to excessive clearances and pressure spikes
P22KAER1	Machined piston seal that includes a custom anti-extrusion ring for equipment exposed to excessive clearances and pressure spikes

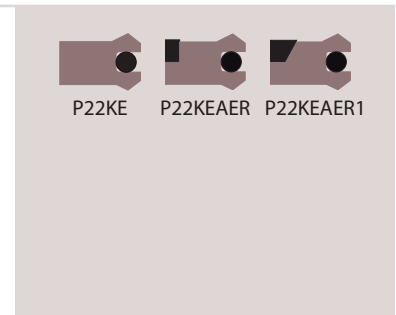

## 23K U-CUPS

A continuous, single-acting, rod or piston design that incorporates a unique, dynamic lip geometry that provides the optimal sealing force required for pneumatic applications.

Profile	Description
P23K	Machined continuous piston seal design





## Piston Seals – Stacked Sets

Stacked V-ring seal designs are most commonly used to ensure ease of installation due to the split design. The sealer rings are nested inside a female/top and a male/bottom adapter. The male adapter centers the sealer rings while also energizing the set under system pressure. The female adapter is designed to support the set and help compensate for extrusion into large equipment clearances.

**8K/27K**

**STACKED SETS**

The pressure activated rod and piston V-ring sets are designed for use in hydraulic applications. The single acting, positive rake profile contacts through the center of the set to ensure even loading, longer sealing life using minimal gland pressure. Most sets are available split or solid.

Profile	Description
P8K	Molded single acting symmetrical seal set, available split or solid
P27K	Machined single acting symmetrical seal set, available split or solid
P27K1	Machined single acting symmetrical seal set with custom adapters for large clearances
P28K	Machined single acting symmetrical seal set for replacement of typical industry sets
P28K1	Machined single acting symmetrical seal set with adapters made from engineered plastics for added support and extrusion resistance
P28K2	Custom machined single acting symmetrical seal set with male adapters made from engineered plastics for added support and extrusion resistance

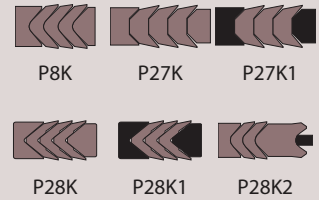

# Piston Seals – Compression

## CCS COMPRESSION

Continuous, two-piece, bi-directional sealing system that uses an elastomer cap with an O-ring to create a very effective seal for single groove cavities in hydraulic applications. The cap is used as the dynamic sealing element while the O-ring energizes the cap and creates a static seal.

Profile	Description
PCCS	Machined two-piece piston seal with an elliptical cap profile for more efficient loading in hydraulic applications
PCCS1	Machined two-piece piston seal with a standard profile for use in hydraulic applications
PCCS2	Machined two-piece piston seal with a rectangular loader for use in highly dynamic hydraulic applications
PCCS3	Machined two-piece piston seal with a stepped cap profile for use in hydraulic applications
PCCS4	Machined two-piece piston seal with a rectangular loader and a stepped cap profile for use in highly dynamic hydraulic applications

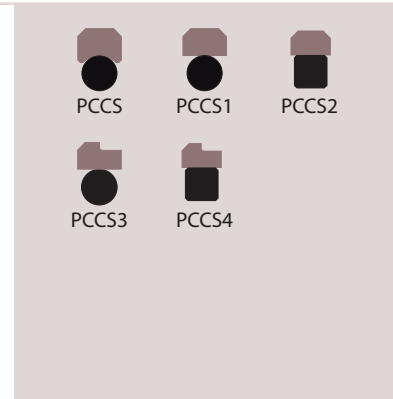

## 20K COMPRESSION

Continuous, bi-directional compression seal designed with dual independent sealing points. The heavy, durable, dual lip design was specifically designed for single groove cavities in heavy duty, high pressure, hydraulic applications. The seal design has the ability to withstand pressure spikes while helping to compensate for equipment side loading.

Profile	Description
P20K1	Machined heavy duty piston seal for use in hydraulic applications
P20K2	Machined heavy duty bi-directional piston seal with two full anti-extrusion rings
P20K3	Machined heavy duty piston seal with two partial anti-extrusion rings
P20K4	Machined heavy duty piston seal with two full L-shaped anti-extrusion rings
P20K5	Machined heavy duty, piston seal with two partial L-shaped anti-extrusion rings
P20K6	Machined heavy duty, piston seal with two partial L-shaped anti-extrusion rings
P20KDAER	Machined heavy duty piston seal with two sturdy rectangular anti-extrusion rings
P20K2P4	Machined heavy duty 4 piece, piston seal with two full L-shaped anti-extrusion rings

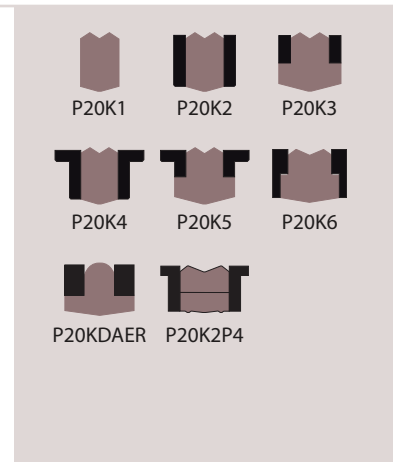

## 7K PISTON CUP

Single acting piston cup has a positive, flared lip design to optimize sealing forces. The molded design is supplied with a supporting metallic brass disc, molded into the base of the seal to prevent over-compression of the flange and improve seal performance. The resulting rigid base provides a stable, non-distorting, anti-extrusion resistant seal. These can also be used back-to-back for double-acting applications.

Profile	Description
P7K	Molded piston cup seal design with built-in supporting metallic brass disc in base to improve stability and anti-extrusion resistance
P7K1	Machined piston cup seal design (does not include a built-in brass disc)

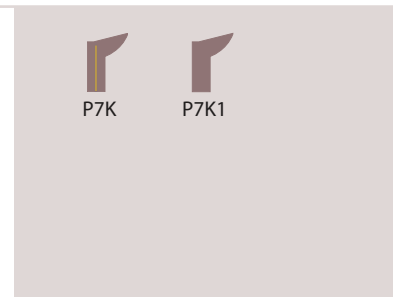

## 20KD PISTON MOUNTED – STATIC FACE

A continuous, high performance compression seal that is most commonly designed for use in static applications and is often applied as an upgrade from conventional O-rings. Designs are available for internal face sealing as well as external face sealing commonly found in single- or double-acting applications.

Profile	Description
P20KDR	Machined seal profile with dynamic side located on the inner diameter
20KOR	Machined rectangular seal for sealing static connecting ports of standard hydraulic valves and control units



## Ancillary Devices – Anti-extrusion Rings (AER)

### 9K ANTI-EXTRUSION RINGS (AER)

Anti-extrusion rings, sometimes referred to as back-up rings, are designed to prevent seals from extruding into equipment clearances while under pressure. Used in conjunction with a seal or O-ring, they are available in various extrusion-resistant materials and are located on the back-side or low pressure side of the sealing element they are supporting.

Profile	Description
R9K	Machined, rectangular profile, rod design
R9KD	Machined, triangular profile used with rod seal
R9K2	Machined, custom profile designed for distinct rod seal design
P9KD	Machined, triangular profile used with distinct piston seal design
P9K2	Machined, custom profile used with distinct piston seal design
ORB	Machined, custom profile used in combination with an O-ring
P9K	Machined, rectangular profile, piston design

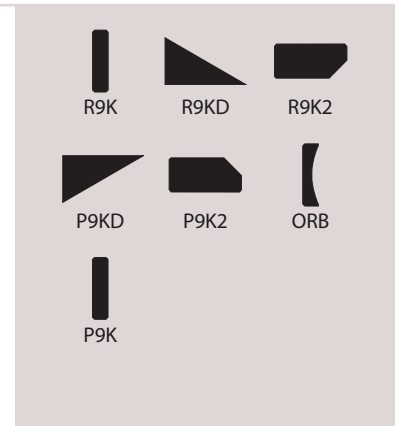

### 16K/17K BEARING ELEMENTS

Bearing Band Strips are the economical solution to costly cylinder re-machining and repairs suitable for use on rams or pistons in reciprocating applications. These split, replaceable bearings prevent metal-to-metal contact of moving parts and help prolong equipment life.

Profile	Description
16K	Molded continuous coil form for metric sizes used for rod and piston applications
17K	Molded continuous coil form for inch sizes used for rod and piston applications



### 18K, 19K BEARING ELEMENTS AND CUSTOM WEAR RINGS

Bearing Bands and wear rings are the solution to costly cylinder re-machining and repairs for hydraulic or pneumatic equipment. These split, replaceable bearings prevent metal-to-metal contact of moving parts and help prolong equipment and seal life. These bearings reduce radial movement, therefore extending seal, life reducing the risk of reoccurring damage.

Profile	Description
18K	Molded imperial sized bearing band for use in medium and heavy duty rod and piston applications made from glass fiber reinforced heat stabilized nylon
19K	Precision machined metric sized bearing band for use in medium and heavy duty rod and piston applications made from glass fiber reinforced heat stabilized nylon
WR	Machined custom sized wear ring for use in light to medium duty rod and piston applications available in various engineered plastics
R9KL	Machined L shaped wear ring for use in light to medium duty rod applications, available in various engineered plastics
P9KL	Machined L shaped wear ring for use in light to medium duty piston applications, available in various engineered plastics
WRTP	Machined T shaped wear ring for use in light to medium duty piston applications, available in various engineered plastics
WRUP	Machined custom designed contoured wear ring for use in light to medium duty piston applications, available in various engineered plastics
WRUR	Machined custom designed wear ring for use in light to medium duty rod applications, available in various engineered plastics
WRTR	Machined T shaped wear ring for use in light to medium duty rod applications, available in various engineered plastics

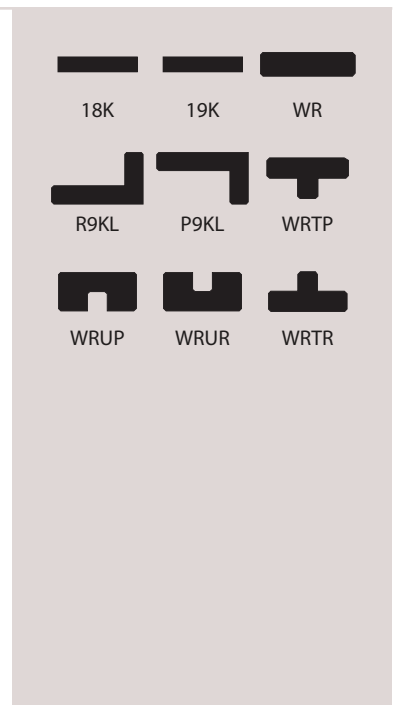

# Rotary Seals

## 14K RESTRICTION BUSHING

Restriction bushings designed for use in rotary equipment to form a barrier between the sealing device in the stuffing box or pump impeller housing and the pump medium. The bushing helps to prevent suspended abrasive particles from entering the stuffing box area and reduces flush requirements. Individually manufactured from various materials, these restriction bushings provide excellent performance in pumps, agitators, mixers, refiners, and other equipment.



Profile	Description
R14K	Machined polymer, restrictor bushing for use in rotary applications
R14K2P	Machined 2-piece restrictor bushing for large cross sections
R14KRBS	Machined spacer designed for use in deep stuffing boxes
R14KPF	Machined virgin PTFE, restrictor bushing for use in rotary applications, for use with aggressive fluids

## 30K BEARING AND GEARBOX PROTECTION

High performance continuous seals that improve on performance of conventional rotary lip seals in bearing and gear box applications. These designs are available in various filled PTFE materials which offer higher speeds, wider temperature range, greater chemical compatibility and longer life.

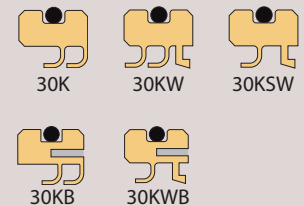

Profile	Description
30K	Machined continuous dual lip replacement seal for high or low speed rotary applications
30KW	Machined continuous dual lip replacement seal with built-in wiper design for high or low speed rotary applications
30KSW	Machined continuous single lip replacement seal with built-in wiper design with limited space for high or low speed rotary applications
30KB	Machined continuous dual lip replacement seal, with metallic stabilizing band, for high or low speed rotary applications
30KWB	Machined continuous dual lip replacement seal, with built-in wiper and metallic stabilizing band, for high or low speed rotary applications

## 33K BEARING AND GEARBOX PROTECTION

High performance split lip seals improve on performance of conventional rotary lip seals in bearing and gear box applications. The split design eliminates the need for equipment disassembly and installation time can be reduced from hours to minutes. Seal available in various PTFE filled materials with polymer adapters.



Profile	Description
33K	Machined split seal for use in high or low speed rotary applications

## 30KC POWDERS AND VISCOUS FLUIDS

High performance polymer cartridge seal for use in dynamic rotary seal applications. This cartridge design uses high performance, filled PTFE materials proven to withstand the high shear rates, frictional heat and abrasives common when pumping high viscosity products and powders.



Profile	Description
30KC	Machined cartridge design for sealing powders and viscous fluids

# Spring Energized Seals

## 100 SERIES CANTILEVER DESIGN

Cantilever spring energized seals are primarily used in highly dynamic applications for rotary and reciprocating equipment because the spring design allows for high deflection with minimal loading. This is the most popular series for spring energized seal designs due to its unique attributes, which help to maximize seal and hardware life.

Profile	Description
100	Machined symmetrical U-cup seal for rod and piston applications
101	Machined U-cup rod seal with a positive rake profile on the dynamic lip
103	Machined symmetrical U-cup face seal
105	Machined symmetrical flanged U-cup rod seal for reciprocating and rotary, flange eliminates seal rotation
107	Machined U-cup piston seal specifically designed for large cross sections
109	Machined U-cup rod seal specifically designed for large cross sections
115	Machined U-cup rod and piston seal for low pressure reciprocating and rotary
119	Machined U-cup piston seal for low pressure reciprocating and rotary
130	Machined U-cup rod and piston seal with support ring for added stability of seal
139	Machined U-cup rod and piston seal designed to isolate media from spring



## 200 SERIES ELLIPTICAL DESIGN

Elliptical coil spring energized seals are commonly used in rotary, reciprocating, and static applications where hardware tolerances are relatively large or where a miniature seal is required. Elliptical coil spring designs allows for minimal deflection while applying intermediate loads.

Profile	Description
200	Machined symmetrical U-cup seal with a standard lip profile
204	Machined symmetrical face seal with a standard lip profile, designed to seal on the inside diameter
205	Machined symmetrical flanged U-cup rod seal for reciprocating and rotary, flange eliminates seal rotation

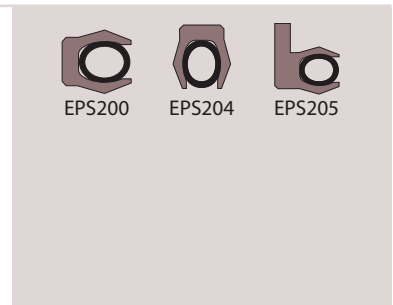

# Spring Energized Seals

## 300 SERIES HELICAL DESIGN

Helical Wound spring energized seals are primarily used in static applications, slow speeds, extremely low temperatures, and/or infrequent dynamic conditions when friction and wear are secondary concerns. The spring design has excellent loading capabilities with minimal deflection.



Profile	Description
300	Machined symmetrical U-cup seal with a standard lip profile
304	Machined symmetrical face seal with a standard lip profile, designed to seal on the inside diameter
305	Machined symmetrical flanged U-cup rod seal for reciprocating and rotary, flange eliminates seal rotation

## 400 SERIES ROTARY

High performance, multi-purpose rotary seals are designed for use in dynamic applications. The unique seal lip design is mechanically formed to provide optimal sealing force. The materials are coupled with an exceptional seal design to provide excellent fluid compatibility and outstanding performance.



Profile	Description
411	Machined lip seal for rod applications to combat equipment with excess eccentricity
414	Machined lip seal for rod applications with spring energized static seal and dimensional stabilizer ring

## 500 SERIES STACKED SETS

High performance, multi-purpose stacked V-ring sets specifically designed to accommodate hardware with deep stuffing boxes. These stacked sets are used in both rotary and reciprocating applications and are available in solid and split designs, depending upon your application requirements.

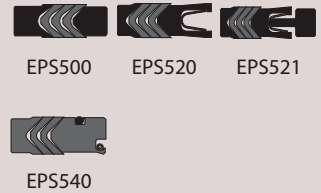

Profile	Description
500	Machined symmetrical V-ring set, split or solid, designed for deep stuffing boxes
520	Machined symmetrical solid V-ring set, with spring loaded primary seal ring, designed for deep stuffing boxes
521	Machined symmetrical solid V-ring set, with spring loaded primary seal ring and stabilizer ring, designed for deep stuffing boxes
540	Machined symmetrical solid V-ring set, with spring loaded primary seal ring, designed for deep stuffing boxes

## Recommended Seal Size

When selecting a seal, it is important to use an appropriate seal cross section according to hardware diameters of either bore or rod. Tables 1 and 2 give recommended seal cross section and height ranges used for Chesterton products. These can be applied to common industry applications for many U-cup type seals. The recommended seal height should be approximately 50% larger than the cross section for seal stability. For applications operating outside of typical industry conditions, it is strongly advised to consult Engineering to determine if these ranges are appropriate.

**TABLE 1 METRIC**

Diameter Range mm		Cross Section Range	Height Range
Min	Max	Min-Max	Min-Max
—	25	3,00-4,00	5,00-6,00
>25	50	3,00-5,00	5,00-7,00
>50	100	4,00-7,00	6,00-11,00
>100	150	5,00-10,00	7,00-14,00
>150	200	6,00-12,00	10,00-19,00
>200	300	10,00-16,00	14,00-24,00
>300	1250+	12,00+	19,00+

**TABLE 2 INCH**

Diameter Range inch		Cross Section Range	Height Range
Min	Max	Min-Max	Min-Max
—	1.000	0.125-0.156	0.187-0.250
>1.000	2.000	0.125-0.187	0.187-0.281
>2.000	4.000	0.156-0.281	0.250-0.437
>4.000	6.000	0.187-0.375	0.281-0.562
>6.000	8.000	0.250-0.500	0.375-0.750
>8.000	12.000	0.375-0.625	0.562-0.937
>12.000	48.000+	0.500+	0.750+

# Standard Fits and Tolerances Data Chart

## Fits and Tolerances – Based on ISO 286-1

These ISO standard tolerance classes are used to define an acceptable size range in the manufacturing or reworking of equipment. The chart below shows generally accepted industry standards for hydraulic and pneumatic equipment. However, caution must be observed that these values may not pertain to all applications.

A tolerance class is combined with a basic size to determine the allowable range. For example, a 420 mm bore with a tolerance class of H9, i.e., 420<sup>H9</sup>, would have a basic size and tolerance of 420 +155/-0 which equals 420,15 to 420,00 mm allowable range of size.

Consult with application engineering for suitability and use of this table.

Diameter Range — Basic Size mm*(inch)		Tolerance (Rod based)	Tolerance (Hole based)	Tolerance (Rod based)	Tolerance (Hole based)
Minimum	Maximum	h9	H9	f11	F11
>6 (.236)	10 (.394)	+ 0/-36 (+0/-0.001)	+36/-0 (+.001/-0)	-13/-103 (-.0005/-0.004)	+103/+13 (+.004/+0.0005)
>10 (.394)	18 (.709)	+ 0/-43 (+0/-0.002)	+43/-0 (+.002/-0)	-16/-126 (-.0006/-0.005)	+126/+16 (+.005/+0.0006)
>18 (.709)	30 (1.181)	+ 0/-52 (+0/-0.002)	+52/-0 (+.002/-0)	-20/-150 (-.0008/-0.006)	+150/+20 (+.006/+0.0008)
>30 (1.181)	50 (1.968)	+ 0/-62 (+0/-0.002)	+62/-0 (+.002/-0)	-25/-185 (-.0009/-0.007)	+185/+25 (+.007/+0.0009)
>50 (1.968)	80 (3.150)	+ 0/-74 (+0/-0.003)	+74/-0 (+.003/-0)	-30/-220 (-.001/-0.009)	+220/+30 (+.009/+0.001)
>80 (3.150)	120 (4.724)	+ 0/-87 (+0/-0.003)	+87/-0 (+.003/-0)	-36/-256 (-.001/-0.010)	+256/+36 (+.010/+0.001)
>120 (4.724)	180 (7.086)	+ 0/-100 (+0/-0.004)	+100/-0 (+.004/-0)	-43/-293 (-.002/-0.011)	+293/+43 (+.011/+0.002)
>180 (7.086)	250 (9.842)	+ 0/-115 (+0/-0.004)	+115/-0 (+.004/-0)	-50/-340 (-.002/-0.013)	+340/+50 (+.013/+0.002)
>250 (9.842)	315 (12.401)	+ 0/-130 (+0/-0.005)	+130/-0 (+.005/-0)	-56/-376 (-.002/-0.015)	+376/+56 (+.015/+0.002)
>315 (12.401)	400 (15.748)	+ 0/-140 (+0/-0.005)	+140/-0 (+.005/-0)	-62/-422 (-.002/-0.017)	+422/+62 (+.017/+0.002)
>400 (15.748)	500 (19.685)	+ 0/-155 (+0/-0.006)	+155/-0 (+.006/-0)	-68/-468 (.003/-0.018)	+468/+68 (+.018/+0.003)
>500 (19.685)	630 (24.803)	+ 0/-175 (+0/-0.007)	+175/-0 (+.007/-0)	-76/-516 (.003/-0.020)	+516/+76 (+.020/+0.003)
>630 (24.803)	800 (31.496)	+ 0/-200 (+0/-0.008)	+200/-0 (+.008/-0)	-80/-580 (-.003/-0.023)	+580/+80 (+.023/+0.003)
>800 (31.496)	1000 (39.370)	+ 0/-230 (+0/-0.009)	+230/-0 (+.009/-0)	-86/-646 (-.003/-0.025)	+646/+86 (+.025/+0.003)
>1000 (39.370)	1250 (49.213)	+ 0/-260 (+0/-0.010)	+260/-0 (+.010/-0)	-98/-758 (-.004/-0.030)	+758/+98 (+.030/+0.004)
>1250 (49.213)	1600 (62.992)	+0/-310 (+0/-0.012)	+310/-0 (+.012/-0)	-110/-890 (-.004/-0.035)	+890/+110 (+.035/+0.004)
>1600 (62.992)	2000 (78.740)	+0/-370 (+0/-0.015)	+370/-0 (+.015/-0)	-120/-1040 (.005/.041)	+1040/+120 (+.041/+0.005)

\* mm values given in .001 mm



# Application of ISO Standards Fits and Tolerances

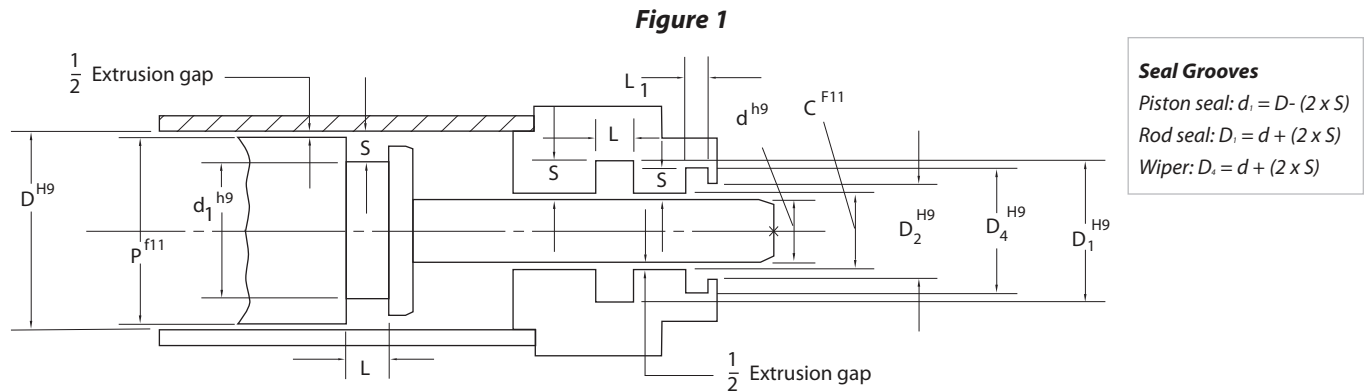

**Figure 1** the examples below illustrate how fits and tolerances can be applied to dimensioning one or more components of the cylinder shown in Figure 1 for metric and inch sizes.

**Bore Dimensioning**

300,00 mm bore with H9 tolerance  
 $D^{H9} = 300,00 \text{ mm} + 130/-0$   
**Allowable size range = 300,13 – 300,00 mm**

**Rod Dimensioning**

3.00" rod with h9 tolerance  
 $d^{h9} = 3.00" + 0/-0.003$   
**Allowable size range = 3.00 – 2.997"**

**Piston Diameter Running Clearance**

Piston diameter P to fit 300,00 mm bore  
 $P^{f11} = 300,00 - 56/-376 \text{ mm}$   
**Allowable size range = 299,94 – 299,62 mm**

**Gland Inside Diameter Running Clearance**

Gland inside diameter to fit 3.00" rod  
 $C^{F11} = 3.00 + .009/+0.001"$   
**Allowable size range = 3.009 – 3.001"**

**Piston seal groove**

300,00 mm bore, piston seal cross section  $S = 12,00 \text{ mm}$   
 $d_1 = D - (2 \times S)$  with h9 tolerance  
 $= 300,00 - (2 \times 12,00) = 276,00 + 0/-130$   
**Allowable size range = 276,00 – 275,87 mm**

**Rod seal groove**

3.00 inch rod, rod seal cross section  $S = .250"$   
 $D_4 = 3.000 + (2 \times .250)$  with H9 tolerance  
 $= 3.500 + .003/-0$   
**Allowable size range = 3.503 – 3.500"**

**Extrusion gap**

Note the resultant extrusion gap on the seal support lands should always be within published limits for the seal profile and material used. Reference "Allowable Extrusion Gap Table" for AWC material and profile ratings.

**Piston seal:** diametrical clearance =  $D - P$

For above bore and piston  
 Maximum extrusion gap =  $D_{max} - P_{min}$   
**= 300,13 – 299,62 mm = 0,51 mm**

**Rod seal:** diametrical clearance =  $C - a$

For above rod and gland  
 Maximum extrusion gap =  $C_{max} - d_{min}$   
**= 3.009 – 2.997 = .012"**

# Miscellaneous Hardware Guidelines—Reciprocating

Figure 1

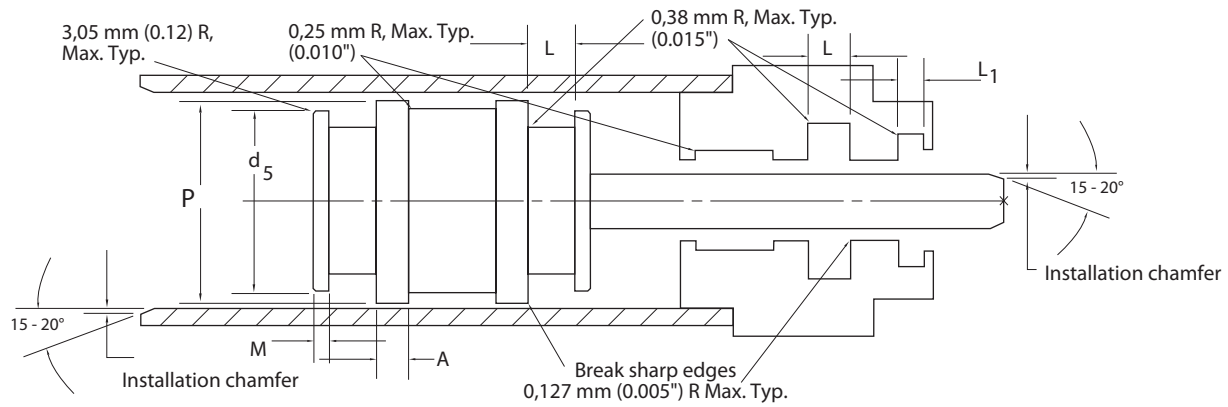

**Table 1** shows common guidelines for hardware design used to ease installation and to prevent damage to seals for typical industrial hydraulic and pneumatic applications.

Note: Piston landing areas **A** & **M** = 3,18 mm (0.125 in) minimum.

TABLE 1				
INSTALLATION CHAMFERS				
Seal cross section range		Chamfer size		
mm	(inch)	mm	(inch)	
< 3,17	(0.125)	1,52	(0.060)	
> 3,17 - 6,35	(0.125 - 0.250)	2,03	(0.080)	
>6.35 - 9,53	(0.250 -0.375)	2,54	(0.100)	
>9,53 – 12,70	(0.375 -0.500)	3,30	(0.130)	
>12,70 – 15,88	(0.500 -0.625)	3,94	(0.155)	
>15,88 – 19,05	(0.625 – 0.750)	4,57	(0.180)	
>19,05 – 22,23	(0.750 - 0.875)	5,08	(0.200)	
>22,23 – 25,40	(0.875 - 1.000)	5,59	(0.220)	
> 25,40	(1.000)	5,84	(0.230)	

**Table 2** provides recommended groove heights for popular Chesterton seal designs. Piston clearance diameter (d<sub>5</sub>) will vary depending on seal profile.

TABLE 2					
GROOVE HEIGHTS					
Profile	Seal clearance height L = H + clearance		Wiper clearance height L1 = H2 + clearance		Ød5
	L	Tolerance	L1	Tolerance	
22K, 22KE, 23K	= Seal height H + 0,76 mm (0.030)	+ ,38 mm/-0 (+.015/-0)	NA		$\frac{= \text{Seal I.D.} + \text{Seal O.D.}}{2}$
20K, 20KD, Cap seal	= Seal height + 0,25 mm (0.010)	+ ,25 mm/-0 (+.010/-0)	NA		Make equal to ØP
5K, 21K, 21KH, 5KT5, 21KT5, 21KR	NA		= Wiper flange height + 0,25 mm (0.010)	+ ,25 mm/-0 (+.010/-0)	NA
5K combo, 21KC	NA		= Seal height + 1,50 mm (0.062)	+ ,38 mm/-0 (+.015/-0)	NA
10K, 22KN	= Seal height + 1,50 mm (0.062)	+ ,38 mm/-0 (+.015/-0)	NA		$\frac{= \text{Seal I.D.} + \text{Seal O.D.}}{2}$

# Miscellaneous Hardware Guidelines—Rotary and Reciprocating

Seals made of PTFE and engineered plastic compounds, and usually spring loaded, are much more rigid as compared to elastomeric seals and can easily be stretched or compressed beyond their elastic limits at installation. Therefore, it is recommended to utilize an open housing like the two-piece and snap-in designs shown in Figure 1.

**Figure 1** represents typical gland designs for PTFE/engineered plastic seals. Examples include common two-piece and open (snap-in) housing designs.

**Figure 1**

**Piston Mount:**

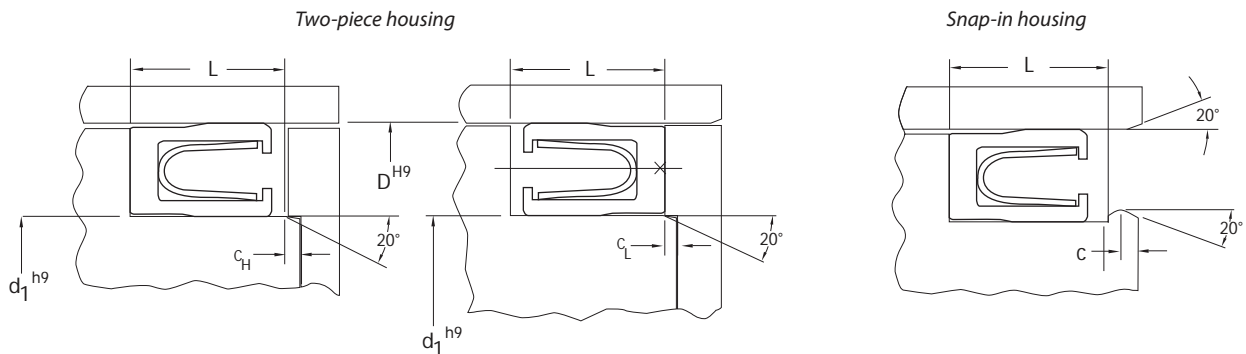

**Rod Mount:**

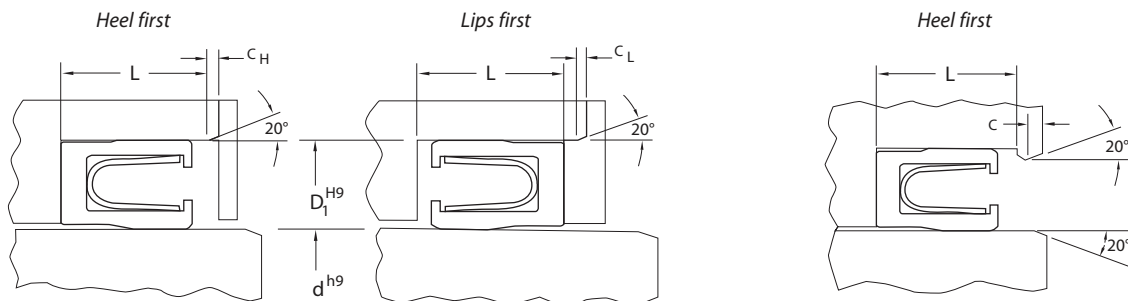

Note: maximum groove radius = 3,50 mm (0.020")

Seal orientation at installation will dictate how much chamfer is required. Seals going into the groove lips first require a longer chamfer to prevent damage during installation. Use the chart below for recommended chamfer.

Seal cross section range	Chamfer C	Installation chamfer C <sub>H</sub>	Installation chamfer C <sub>L</sub>
<2,36 mm (0.093")	1,14 mm (0.045")	0,51 mm (0.020")	1,27 mm (0.050")
> 2,36 mm (0.093") – 3,17 mm (0.125")	1,52 mm (0.060")	0,76 mm (0.030")	1,78 mm (0.070")
> 3,17 mm (0.125") – 6,35 mm (0.250")	2,03 mm (0.080")	1,02 mm (0.040")	2,29 mm (0.090")
> 6,35 mm (0.250") – 9,53 mm (0.375")	2,54 mm (0.100")	1,27 mm (0.050")	3,56 mm (0.140")
> 9,53 mm (0.375") – 12,70 mm (0.500")	3,30 mm (0.130")		
> 12,70 mm (0.500") – 5,88 mm (0.625")	3,94 mm (0.155")		
> 15,88 mm (0.625") – 19,05 mm (0.750")	4,57 mm (0.180")		
> 19,05 mm (0.750") – 22,23 mm (0.875")	5,08 mm (0.200")		
> 22,23 mm (0.875") – 25,40 mm (1.000")	5,59 mm (0.220")		
>25,40 mm (1.000")	5,84 mm (0.230")		

Note – seals above 2,70mm (0.500 in) cross section will utilize two springs.

# Miscellaneous Hardware Guidelines—Replaceable Bearing Bands

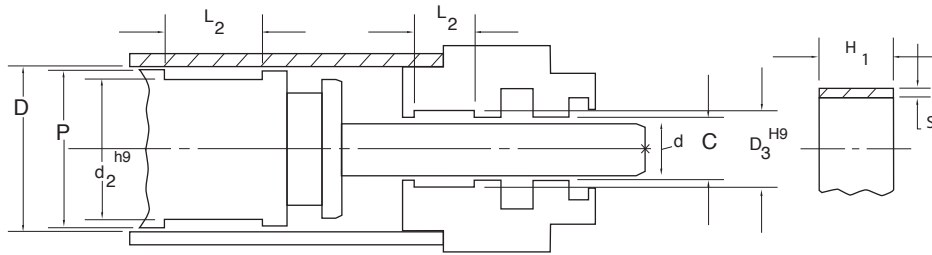

**Groove width L<sub>2</sub>**  
 $L_2 = H_1 + 0,25 \text{ mm tol. } +0,25/-0$   
 $(H_1 + 0.010" \text{ tol. } +0.010/-0)$

The chart below gives dimensional data for hardware clearances and groove design for all Chesterton replaceable bearing bands. The use of replaceable bearing bands necessitates larger clearance gaps for the prevention of metal to metal contact. Consequently, the resulting extrusion gap will be larger for the seal support land. Always ascertain the clearance obtained from this chart is within the allowable ratings for the seal material used.

**Bearing band groove diameters**

Piston mount:  $d_2 = D - (2 \times S) - Rc$  with h9 tolerance  
 Rod mount:  $D_3 = d + (2 \times S) + Rc$  with H9 tolerance

**Piston and Gland clearance diameters**

Piston diameter P = Actual bore – “piston to bore clearance” and “tolerance” from chart  
 Gland inside diameter C = Actual rod + “rod to gland clearance” and “tolerance” from chart

**Example 1:** 200 mm bore with S = 2,50 mm  
 $d_2 = [200,00 - (2 \times 2,50) - 0,11] +0/-115 = \mathbf{194,89 +0/-115}$   
 Size range with tolerance = 194,89 to 194,77 mm

$P = 200,00 - 0,48 = 199,52 +0/-,10$   
 Size range with tolerance = 199,52 to 199,42 mm  
 Extrusion gap = 200 mm – 199,88 = 0,22 mm

**Example 2:** 2.500" rod with S = .125"  
 $D_3 = [2.500 + (2 \times .125) + .003] +.003/-0 = \mathbf{2.758 +.003/-0}$   
 Size range with tolerance = 2.761 to 2.758"

$C = 2.500 + .018 = 2.518 +.003/-0$   
 Size range with tolerance = 2.521 to 2.518  
 Extrusion gap = 2.521 – 2.500 = 0.021"

BEARING BAND GROOVE DIMENSIONS								
Dia. Range Basic size mm*(inch)		Piston to Bore Clearance		Rod to Gland Clearance		Running Clearance	ISO Tolerance	
Min.	≤ Max.	(D-P)	Tolerance	(C-d)	Tolerance	Rc	H9	h9
	50 (1.968)	0,43 (.017)	+0/-,05 (+0/-,002)	0,43 (0.17)	+ ,05/-0 (+.002/-0)	0,06 (.002)	+62/-0 (+.002/-0)	+0/-62 (+0/-,002)
50 (1.968)	120 (4.724)	0,46 (.018)	+0/-,07 (+0/-,003)	0,46 (0.018)	+ ,07/-0 (+.003/-0)	0,08 (.003)	+87/-0 (+.003/-0)	+0/-87 (+0/-,003)
120 (4.724)	250 (9.842)	0,48 (.019)	+0/-,10 (+0/-,004)	0,48 (.019)	+ ,10/-0 (+.004/-0)	0,11 (.004)	+115/-0 (+.004/-0)	+0/-115 (+0/-,004)
250 (9.842)	500 (19.685)	0,51 (.020)	+0/-,12 (+0/-,005)	0,51 (.020)	+ ,12/-0 (+.005/-0)	0,15 (.006)	+155/-0 (+.006/-0)	+0/-155 (+0/-,006)
500 (19.685)	800 (31.496)	0,53 (.021)	+0/-,15 (+0/-,006)	0,53 (0.21)	+ ,15/-0 (+.006/-0)	0,20 (.008)	+200/-0 (+.008/-0)	+0/-200 (+0/-,008)
800 (31.496)	1000 (39.370)	0,56 (.022)	+0/-,18 (+0/-,007)	0,56 (.022)	+ ,18/-0 (+.007/-0)	0,23 (.009)	+230/-0 (+.009/-0)	+0/-230 (+0/-,009)

\*mm values given in 0.001 mm

# Allowable Diametrical Clearance

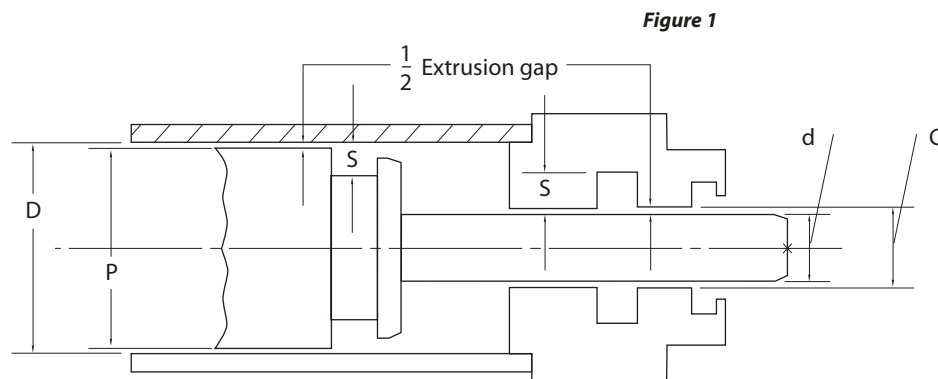

**Diametrical clearance**  
 Piston seal =  $D - P$   
 Rod seal =  $C - d$

### Extrusion gap

The maximum clearance gap formed between hardware components must be held to a minimum to prevent seal extrusion and premature failure. See Figure 1 for typical rod and piston seal extrusion locations and reference Table 1 for maximum values according to system pressure vs. material used. For clearance gaps beyond the recommended values in Table 1 the use of a back up ring is recommended.

TABLE 1

PRESSURE vs. MAXIMUM ALLOWABLE DIAMETRICAL CLEARANCE mm (inch)										
Material	Pressure bar (psi)									
	100 (1450)	200 (2900)	300 (4350)	400 (5800)	500 (7250)	600 (8700)	700 (10150)	800 (11600)	900 (13050)	1000 (14500)
<b>AWC800, 860</b>	0,75 (0.030)	0,75 (0.030)	0,51 (0.020)	0,38 (0.015)	0,32 (0.013)	0,25 (0.010)	0,23 (0.009)	0,19 (0.007)	0,15 (0.006)	0,10 (0.004)
<b>AWC830</b>	0,74 (0.029)	0,56 (0.022)	0,32 (0.013)	0,15 (0.006)	0,13 (0.005)	<b>Contact Engineering</b>				
<b>AWC700, 701, 727, 742</b>	0,70 (0.028)	0,44 (0.017)	0,23 (0.009)							
<b>PTFE Compounds*</b>	0,43 (0.017)	0,33 (0.013)	0,23 (0.009)	0,18 (0.007)	0,13 (0.005)					
<b>PEEK Compounds AWC630, 635</b>	1,90 (0.075)	1,90 (0.075)	1,27 (0.050)	1,00 (0.039)	0,84 (0.033)					
<b>UHMWPE Compounds AWC610, 615, 620, 625</b>	0,75 (0.030)	0,75 (0.030)	0,51 (0.020)	0,38 (0.015)	0,32 (0.013)					

\*PTFE Compounds include; AWC100, AWC220, AWC300, AWC400, AWC440, AW500, AWC510, AWC520, AWC530, AWC550 PEEK® is a trademark of Victrex plc.  
 Contact engineering for circumstances beyond the recommendations provided.

# Surface Finish

Surface finish or roughness is a measure of the irregularities (peaks and valleys) produced on a sealing surface according to the manufacturing process used to create the surface. Adhering to recommended finish ranges can have a profound effect on seal performance by limiting the effects of friction and reducing abrasive seal wear. An optimal surface texture will have ideal pocket depths to retain lubrication in small enough volumes to provide a thin lubrication film between seal and surface, thereby reducing friction and seal wear. If the surface is too rough, it will abrade the seal surface by plowing grooves in it and create a leak path. Alternatively, a surface that is too smooth will increase friction and wear because it does not have the ability to retain enough lubrication to provide a boundary lubrication film.

The parameters defined in ISO 4287 and ISO 4288 are measured or calculated from the roughness mean line as shown in the representative profile texture sample in Figure 1. The most commonly used values of R (arithmetic average) and  $R_q$  (root mean square) are used to quantify the overall size of the profile and the values of R (max roughness height in sample length), R (max roughness valley depth), R (max average roughness height within multiple sample lengths), and  $R_{mr}$  (amount of surface contact at a zero reference line) are used to describe the nature of the peaks and valleys. Figure 2 shows an example of how the nature of a surface profile can differ with the same overall profile height (R or RMS) as Figure 1. See Table 1 for common industry standards for surface finish values.

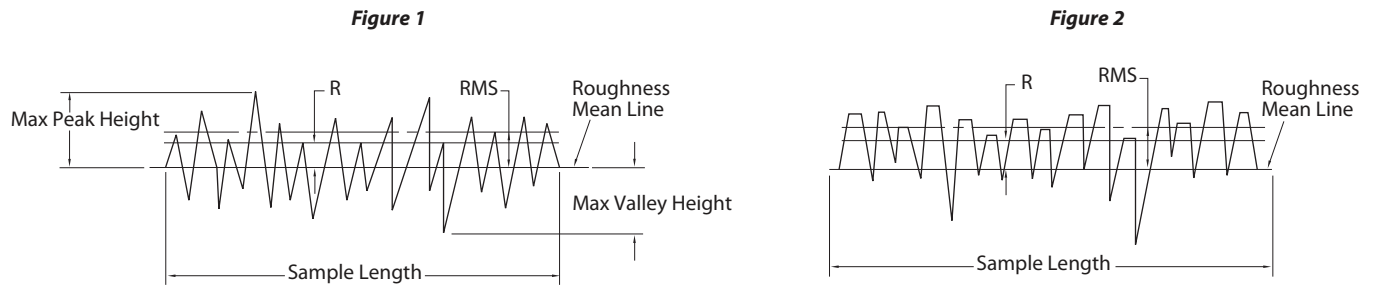

TABLE 1

RECOMMENDED SURFACE FINISHES FOR CHESTERTON MATERIALS			
Material	Static $\mu\text{m } R_a$ ( $\mu\text{in } R_a$ )	Dynamic $\mu\text{m } R_a$ ( $\mu\text{in } R_a$ )	Conversion values
<b>AWC800, 860</b>	0,76 – 1,17 $\mu\text{m}$ (30 – 46 $\mu\text{in}$ )	0,20 – 0,61 $\mu\text{m}$ (8 – 24 $\mu\text{in}$ )	1 $\mu\text{in}$ = 0.0254 $\mu\text{m}$ 1 $\mu\text{m}$ = 39.37 $\mu\text{in}$ $R_q \approx R_a + 10 - 30\%$
<b>AWC805</b>	0,76 – 1,42 $\mu\text{m}$ (30 – 56 $\mu\text{in}$ )	0,20 – 1,17 $\mu\text{m}$ (8 – 46 $\mu\text{in}$ )	
<b>AWC830</b>	0,81 – 1,17 $\mu\text{m}$ (32 – 46 $\mu\text{in}$ )	0,20 – 0,61 $\mu\text{m}$ (8 – 24 $\mu\text{in}$ )	
<b>AWC700, 701, 727, 742, 743, 750</b>	0,81 – 1,17 $\mu\text{m}$ (32 – 46 $\mu\text{in}$ )	0,20 – 0,61 $\mu\text{m}$ (8 – 24 $\mu\text{in}$ )	
<b>PTFE compounds*</b>	0,40 – 0,80 $\mu\text{m}$ (16 – 32 $\mu\text{in}$ )	0,20 – 0,40 $\mu\text{m}$ (8 – 16 $\mu\text{in}$ )	
<b>PEEK compounds AWC630, 635</b>	0,40 – 0,80 $\mu\text{m}$ (16 – 32 $\mu\text{in}$ )	0,20 – 0,40 $\mu\text{m}$ (8 – 16 $\mu\text{in}$ )	
<b>UHMWPE compounds AWC610, 615, 620, 625</b>	0,40 – 0,80 $\mu\text{m}$ (16 – 32 $\mu\text{in}$ )	0,20 – 0,40 $\mu\text{m}$ (8 – 16 $\mu\text{in}$ )	

\*Compounds include: AWC100, AWC220, AWC300, AWC400, AWC440, AWC500, AWC510, AWC520, AWC530, AWC550  
PEEK® is a trademark of Victrex plc.

# Eccentricity and Dynamic Runout for Spring Energized Seals

All rotating shafts will experience some degree of lack of concentricity or misalignment with the bore, resulting in eccentricity during operation. The amount of deviation can have a significant impact on seal performance especially with spring loaded seals with PTFE and engineered plastic jackets. Shown below are the two components, static misalignment and dynamic runout, that combined result in the total eccentricity.

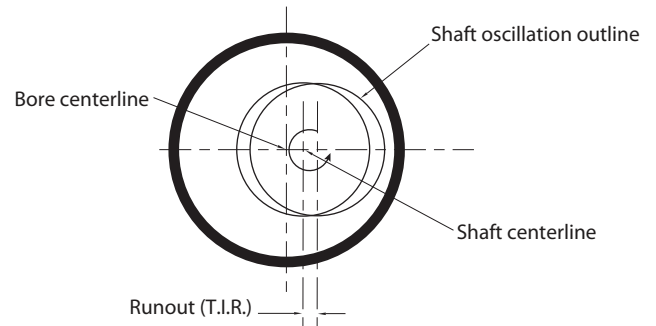
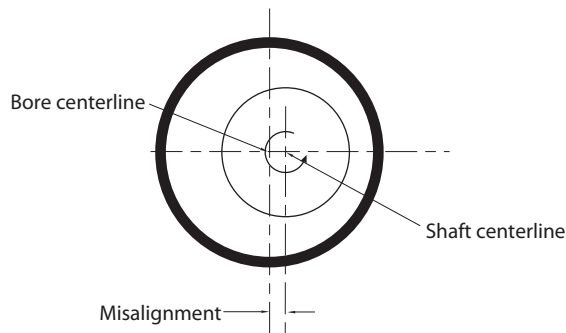

### Static: Shaft to Bore Misalignment

Misalignment occurs when the shaft centerline is offset from the bore centerline creating an asymmetrical clearance gap (e.g., shaft is not centered in the bore). This results in increased compression and wear of seal on one side and an enlarged extrusion gap on the other.

### Dynamic: Runout (T.I.R.)

Shaft runout occurs when the shaft axis of rotation is different than the shaft centerline, resulting in shaft oscillating when it rotates. The effect on the seal is that it sees cyclic compression/decompression and accelerated wear on one side of the seal.

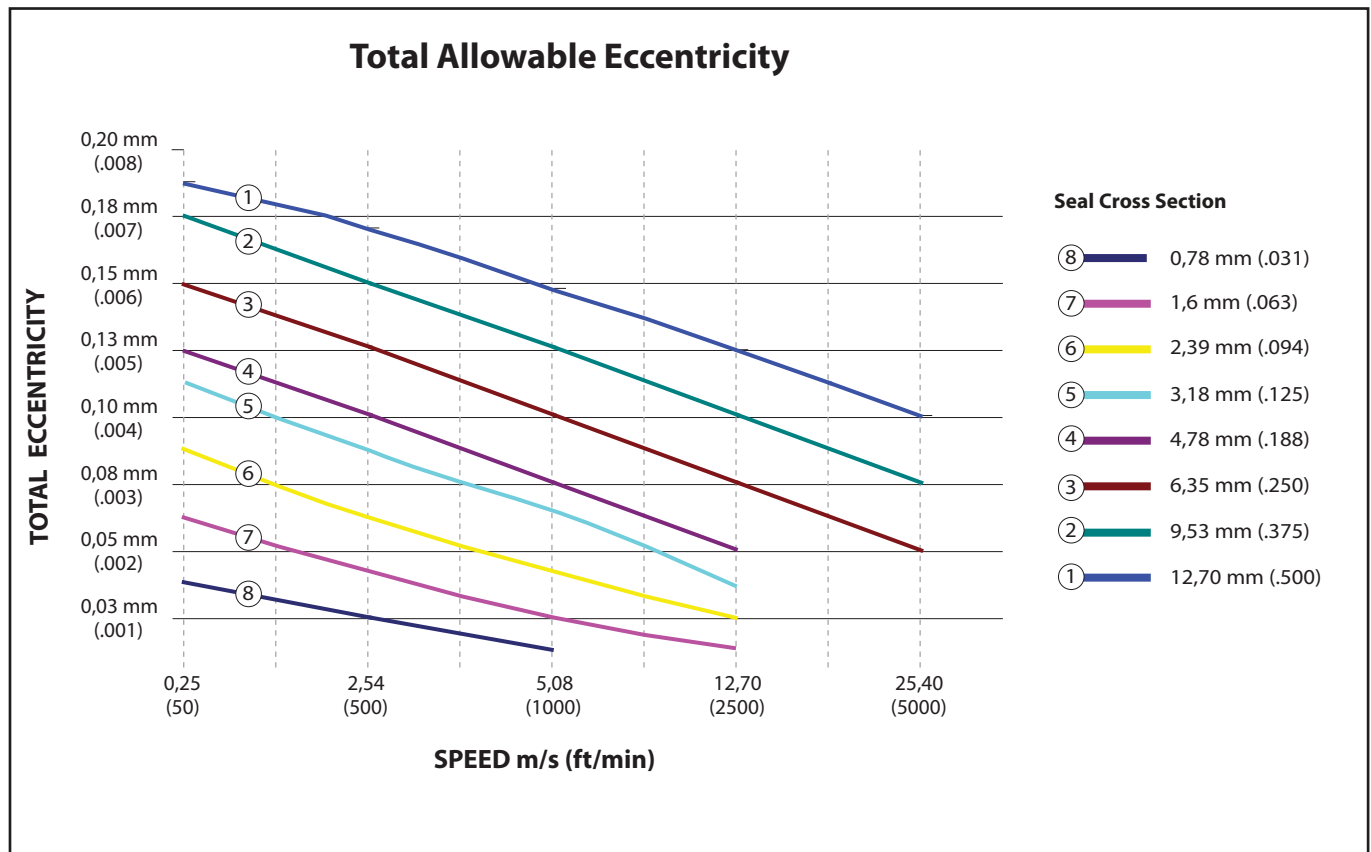

Reference material listing for limitations.

**FLUOROPLASTICS**

Material Information			
Material code	Material	General Usage	Color
AWC100	Polyimide filled PTFE	Dry running or low viscosity petroleum-based applications. Highest PV value, mechanical toughness and can be used in elevated temperatures with excellent fluid compatibility.	Dark yellow
AWC220	Glass filled modified PTFE	Higher wear resistant properties and lower friction compared to conventional PTFE. Good where cleaner environments are required. Good in more abrasive and high viscous media. Less abrasive on mating surfaces than carbon filled PTFE materials.	Off white
AWC300	Glass + MoS2 filled PTFE	High wear, high pressure and high speed applications. High PV values with excellent fluid compatibility. Excellent in high viscosity fluids.	Dark gray
AWC400	Carbon/graphite filled PTFE	Water and steam applications. High PV values. Excellent all-purpose material for rotary applications. Good electrical conductivity.	Black
AWC440	Carbon/graphite filled modified PTFE	Higher wear resistance in water and steam applications. Good in dry and pneumatic applications. Excellent chemical resistance. Largest pH range, H <sub>2</sub> S and solvents.	Black
AWC500	40% bronze filled PTFE	Good bearing and extrusion properties. Bronze provides higher thermal conductivity, allowing higher running velocities. Chemical resistance is somewhat lowered because bronze is attacked by some acids and alkalis. Best used in high pressure hydraulic applications.	Light brown
AWC510	Mineral filled PTFE (FDA)	FDA listed material with better wear resistance than unfilled PTFE. Excellent where cleaner environments are required.	White
AWC520	Virgin PTFE (FDA)	Static or slow speed applications with low wear resistance. Works well in vacuum and low gas permeability applications. Superior fluid compatibility.	White
AWC530	EkonoI® filled PTFE	Good wear and heat resistant properties. High vacuum service in dynamic conditions for moderate speed and higher pressure applications. High temperature non-aqueous applications.	Cream
AWC550	60% Bronze filled modified PTFE	Higher bearing and extrusion properties with improved wear rates. Good thermal conductivity, allowing higher running velocities with limited chemical resistance in some acids and alkalis. Best suited for higher-pressure hydraulic applications.	Brown

EkonoI® is a trademark of Carborundum Company



Hardness	Tensile Strength	Elongation at break	Temperature	Limitations	Material code
60 Shore D +/-5	17.3 Mpa (2,500 psi)	200%	-100 to 260°C (-148 to 500°F)	Not recommended with water and steam.	AWC100
62 Shore D +/-5	24.1 Mpa (3,492 psi)	373%	-100 to 260°C (-148 to 500°F)	Can be abrasive against soft mating surfaces.	AWC220
65 Shore D +/-5	18.3 Mpa (2,650 psi)	265%	-100 to 260°C (-100 to 500°F)	Abrasive against soft metal in high pressure dynamic applications.	AWC300
62 Shore D +/-5	17.3 Mpa (2,500 psi)	200%	-100 to 260°C (-148 to 500°F)	Can be abrasive.	AWC400
65 Shore D +/-5	21.3 Mpa (3,087 psi)	296%	-100 to 260°C (-148 to 500°F)	Can be abrasive.	AWC440
62 Shore D +/-5	22.8 Mpa (3,307 psi)	250%	-100 to 260°C (-150 to 500°F)	Limited chemical resistance. Limited speed range.	AWC500
65 Shore D +/-5	19.3 Mpa (2,799 psi)	250%	-100 to 260°C (-148 to 500°F)	Limited wear resistance.	AWC510
62 Shore D +/-5	24.2 Mpa (3,500 psi)	350%	-150 to 232°C (-238 to 450°F)	Poor wear material and creep resistance.	AWC520
62 Shore D +/-5	19.33 Mpa (2,800 psi)	250%	-100 to 260°C (-148 to 500°F)	Limited use with water and steam.	AWC530
65 Shore D +/-5	17.0 Mpa (2,472 psi)	259%	-100 to 260°C (-148 to 500°F)	Limited chemical resistance. Limited speed range.	AWC550

**ELASTOMERS**

Material Information			
Material code	Description (abbreviation)	General Usage	Color
AWC700	Fluoroelastomer FKM	Best heat resistance and compatibility with aggressive fluids, such as phosphate esters, synthetic hydraulic fluids, many chemicals, and organic solvents. Very good ozone, weather, and aging resistance. Moderate wear and tear resistance.	Black
AWC701	Fluoroelastomer FKM	Best heat resistance and compatibility with aggressive fluid, such as phosphate esters, synthetic hydraulic fluids, many chemicals, and organic solvents. Very good ozone, weather, and aging resistance. Moderate wear and tear resistance.	Brown
AWC715	Fluoroelastomer FKM (FDA)	O-ring material. Best compatibility with aggressive fluids such as phosphate esters, synthetic hydraulic fluids, many chemicals, and organic solvents. Very good ozone, weather, and aging resistance.	Black
AWC727	Fluoroelastomer TFE	Superior heat resistance. Compatible with steam/hot water with a recommended operating range of -10°C to 170°C (14°F to 338°F). Best compatibility with phosphate esters, amines, engine oils, pulp and paper liquors, and high concentrations of acid/alkali/oxidant.	Black
AWC730	Fluoroelastomer FKM	O-ring material. Best heat resistance and compatibility with aggressive fluids, such as phosphate esters, synthetic hydraulic fluids, many chemicals, and organic solvents. Very good ozone, weather, and aging resistance. Moderate wear and tear resistance.	Black
AWC740	acrylonitrile butadiene rubber NBR	O-ring material. Good general purpose elastomer material. Compatible in hydrocarbon-based fluids, alkalis, and acids. Low permanent set and good elasticity.	Black
AWC741	acrylonitrile butadiene rubber NBR (FDA)	Good general purpose elastomer material. Compatible in hydrocarbon-based fluids, alkalis, and acids. Low permanent set and good elasticity.	White
AWC742	acrylonitrile butadiene rubber NBR	Good general purpose elastomer material. Compatible in hydrocarbon-based fluids, alkalis, and acids. Low permanent set and good elasticity. Oil resistant cost competitive material.	Black
AWC750	ethylene propylene diene monomer rubber EPDM	O-ring material. Good general purpose, low temperature elastomer material. Compatible with water, steam, and phosphate ester-based fluids. Excellent UV stability.	Black
AWC800	thermoset polyurethane EU	Excellent wear and tear resistance with low compression set. Compatible with most hydraulic fluids except synthetics. Excellent extrusion resistance at high pressure. Superior performance in hydraulic and pneumatic and slow rotary applications.	Red
AWC805	thermoset polyurethane EU	Good wear and tear resistance and low compression set. Compatible with most hydraulic fluids, except synthetics. Performs well in slightly scored or worn equipment.	Blue
AWC830	thermoset polyurethane EU (FDA approved)	For use in food and pharmaceutical applications where FDA listed material is required.	Off white
AWC860	thermoset polyurethane EU	Higher temperature use. Excellent wear and tear resistance with low compression set. Compatible with most hydraulic fluids except synthetics. Superior performance in hydraulic and pneumatic and slow rotary applications. Excellent extrusion resistance at high pressure.	Cherry

Hardness	Tensile strength	Elongation at break	Temperature	Limitations	Material code
88 Shore A	14.57 Mpa (2,110 psi)	134%	-30 to 200°C (-22 to 400°F)	Not resistant to water, steam, glycols, ketones, and fluids with amines.	AWC700
85 Shore A	>10.0 Mpa (1,450 psi)	>200%	-30 to 200°C (-22 to 400°F)	Not resistant to water, steam, glycols, ketones, and fluids with amine.	AWC701
75 Shore A	16.6 Mpa (2,408 psi)	311%	-30 to 200°C (-20 to 400°F)	Not resistant to water, steam, glycols, ketones, and fluids with amine.	AWC715
85 Shore A	7.2 Mpa (1,040 psi)	236%	-10 to 220°C (14 to 428°F)	Not chemically resistant to glycols, ketones and fluids with amine.	AWC727
75 Shore A	13.76 Mpa (1,996 psi)	200%	-30 to 200°C (-20 to 400°F)	Not resistant to water, steam, glycols, ketones, and fluids with amine.	AWC730
70 Shore A	17.1 Mpa (2,476 psi)	385%	-30 to 121°C (-20 to 250°F)	Not chemically resistant to phosphate ester fluids, strong acids, and automotive brake fluids.	AWC740
85 Shore A	15.0 Mpa (2,175 psi)	100%	-35 to 100°C (-32 to 200°F)	Not chemically resistant to phosphate ester fluids, strong acids, and brake fluids.	AWC741
85 Shore A	17.0 Mpa (2,460 psi)	100%	-35 to 100°C (-31 to 212°F)	Not chemically resistant to phosphate ester fluids, strong acids and brake fluids.	AWC742
85 Shore A	13.9 Mpa (2,022 psi)	130%	-55 to 150°C (-67 to 302°F)	Not chemically resistant to mineral oil products.	AWC750
95 Shore A	34.5 Mpa (5,000 psi)	400%	-50 to 85°C (-58 to 185°F)	Not chemically resistant to hot water/steam and strong acids and alkalis.	AWC800
85 Shore A	30.4 Mpa (4,400 psi)	580%	-50 to 85°C (-40 to 185°F)	Not chemically resistant to hot water/steam and strong acids and alkalis.	AWC805
90 Shore A	53.86 Mpa (7,800 psi)	430%	-35 to 75°C (-31 to 167°F)	Not chemically resistant to hot water/steam and strong acids and alkalis.	AWC830
95 Shore A	42.6 Mpa (6,180 psi)	540%	-50 to 120°C (-58 to 248°F)	Not chemically resistant to hot water/steam and strong acids and alkalis.	AWC860

**ENGINEERED PLASTICS**

Material Information			
Material code	Description (abbreviation)	General Usage	Color
AWC600	Polyester TPE	Applications requiring strong resistance to tear, creep, and abrasion. Some elastic characteristics. Good against rougher surface finishes.	Black
AWC610	Unfilled ultra high molecular weight polyethylene UHMWPE (FDA)	Highly abrasion resistant in reciprocating or slow rotary applications. Excellent in water-based fluids. Economical and excellent in cryogenic applications.	White translucent
AWC615	High Temp ultra high molecular weight polyethylene UHMWPE (FDA)	Wear and abrasion resistance properties. Good in dry applications. Excellent chemical resistance. Large pH range and solvents. Excellent in cryogenic applications. Good upper temperature limit.	White translucent
AWC620	Premium iron oxide filled ultra high molecular weight polyethylene UHMWPE	Better wear and abrasion resistant properties than unfilled UHMWPE. Reciprocating or slow rotary applications. Excellent in water-based fluids.	White translucent
AWC625	Glass filled ultra high molecular weight polyethylene UHMWPE	Abrasive, high wear, reciprocating or slow rotary applications. Excellent in water-based fluids but chemical compatibility and upper temperatures are limited.	Yellow translucent
AWC630	Unfilled polyetheretherketone PEEK	Better wear characteristics. Tough, reliable and dimensionally stable, even under continuous elevated temperatures. Excellent wear characteristics for seals and bearings. Compressive strength 124 Mpa (18,000 psi).	Tan
AWC635	Glass filled polyetheretherketone PEEK	Designed for improving the wear rate of unfilled PEEK (AWC630) in high performance applications. Tough, reliable and dimensionally stable, even under continuous elevated temperatures. Good back up ring material in back up ring applications.	Tan
AWC650	Polyoxymethylene (Acetal) POM (FDA)	Anti-extrusion rings or medium load-bearing applications. Excellent creep resistance under continuous load, fatigue and endurance under repeated cycles. Compressive strength 55.2 Mpa (8,000 psi).	White or black
AWC660	Polyamide (Glass filled Nylon)	Excellent wear characteristics and load-bearing capability. Low fluid absorption and low friction. Compressive strength 158.8 Mpa (23,000 psi).	Black
AWC663	Polyamide Nylon	Good general purpose polyamide material. Bearing material. Compressive strength 90-100 Mpa (13,050-14,500 psi).	Off white
AWC665	Polyamide with MoS2 Nylon	Better wear properties with MoS2 than unfilled material. Bearing material. Compressive strength 100-110 Mpa (14,500-15,950 psi).	Black

PEEK is a trademark of Victrex Co. Ltd.

Hardness	Tensile strength	Elongation at break	Temperature	Limitations	Material code
55 Shore D +/-5	40.0 Mpa (4,802 psi)	500%	-40 to 110°C (-40 to 230)°F	Limited temperature range.	AWC600
64 Shore D +/-5	38.7-48.33 Mpa (5,600-7,000 psi)	350-526%	-200 to 82°C (-325 to 180)°F	Limited temperature and speed range.	AWC610
64 Shore D +/-5	48.3 Mpa (7,000 psi)	242%	-200 to 110°C (-325 to 230)°F	Limited size availability.	AWC615
64 Shore D +/-5	37.98 Mpa (5,500 psi)	300%	-200 to 82°C (-325 to 180)°F	Limited temperature and speed range.	AWC620
64 Shore D +/-5	34.52 Mpa (5,000 psi)	250%	-200 to 82°C (-325 to 180)°F	Limited temperature and speed range.	AWC625
126 Rockwell R +/-5	70.4-103.6 Mpa (10,200-15,000 psi)	5%	-73 to 249°C (-100 to 480)°F	Limited speed range.	AWC630
124 Rockwell R +/-5	155.8 Mpa (22,600 psi)	2%	-50 to 249°C (-60 to 480)°F	Limited speed range.	AWC635
116 Rockwell R +/-5	69 Mpa (10,000 psi)	30%	-40 to 90°C (-40 to 200)°F	Limited chemical resistance and temperature range.	AWC650
85 Shore D +/-5	172.6 Mpa (25,000 psi)	3%	-40 to 110°C (-40 to 230)°F	Limited chemical resistance and temperature range.	AWC660
84 Shore D +/-5	75-85 Mpa (10,875-12,325 psi)	>25%	-40 to 110°C (-40 to 230)°F	Limited chemical resistance and temperature range. Higher fluid absorption.	AWC663
84 Shore D +/-5	80-90 Mpa (11,600-13,050 psi)	>20%	-40 to 110°C (-40 to 230)°F	Higher fluid absorption.	AWC665

**FLUID COMPATIBILITY GUIDE<sup>1</sup>**

Fluid	PUR (EU)	PTFE (unfilled)	UHMW PE	NBR	FKM	PEEK®	Nylon (Nylon)	POM (Acetal)
Acetoyde	NR	C	NR	NR	NR	C	C	C
Acetamide	NR	C	C	C	NR		C	C
Acetate Solvent	NR	C	C	NR	NR		C	
Acetic Acid	NR	C	C	NR	NR	C	NR	NR
Acetic Acid, 20%	M	C	C	NR	NR		NR	M
Acetic Anhydride	NR	C	NR	NR	NR		C	NR
Acetone	NR	C	M	NR	NR	C	M	C
Acetyl Bromide	NR	C		NR			NR	
Acetyl Chloride	NR	C		NR	NR			
Acetylene	NR	C	NR	C	C	C	C	C
Acrylonitrile	NR	C	C	NR	NR	C	C	
Adipic Acid	C	C	C	M	C			
Aluminum Chloride	M	C	M	C	C	C	M	
Aluminum Fluoride	NR	C	C	C	C		C	M
Aluminum Hydroxide	NR	C	C	C	C		C	C
Aluminum Nitrate	NR	C	C	C	C		C	M
Alum. Potassium Sulfate		C	C	C	C		NR	M
Aluminum Sulfate	M	C	C	C	C	C	C	M
Aluminum Sulfide	M	C		C	C			
Amines		C	NR	NR	NR		NR	NR
Ammonia/Cold	M	C		C	NR	C	NR	
Ammonia Nitrate		C	C	C	NR		NR	M
Ammonia, Anhydrous	NR	C	M	NR	NR	C	C	NR
Ammonia, Liquid	NR	C	NR	M	NR	C	M	NR
Ammonium Acetate	NR	C	C	M	C		C	
Ammonium Bifluoride		C	C	M	C			NR
Ammonium Carbonate	M	C	M	NR	C		C	NR
Ammonium Chloride	NR	C	C	NR	C	C	M	M
Ammonium Hydroxide	NR	C	C	NR	NR	C	C	M
Ammonium Nitrate	M	C	C	C	C	C	C	C
Ammonium Persulfate	M	C	C	NR	NR		NR	NR
Ammonium Sulfate	M	C	C	C	NR		C	M
Ammonium Sulfide	M	C		C	NR			
Ammonium Thiocyanate	M	C		M	M			
Amyl Acetate	NR	C	NR	NR	NR	C	M	M
Amyl Alcohol	NR	C		M	M		C	C
Amyl Chloride	NR	C	NR	NR	C		M	C
Aniline	NR	C	NR	NR	M	C	C	C
Aniline Hydrochloride	NR	C	NR	NR	NR		NR	
Animal Fats	M	C		M	M	C		
Antimony Salts	M			M	M	C		
Antimony Trichloride	NR	C	M	NR	C	C	NR	
Aqua Regia	NR	C	M	NR	M	NR	NR	NR
Aromatic Hydrocarbons	NR		NR	NR	C	C		C
Arsenic Acid	NR	C	M	C	C		M	NR
Arsenic Salts	C				NR		C	
ASTM Oil #1	C	C		M	M			

Fluid	PUR (EU)	PTFE (unfilled)	UHMW PE	NBR	FKM	PEEK®	Nylon (Nylon)	POM (Acetal)
ASTM Oil #2	M	C		M	M			
ASTM Oil #3	M	C		M	M			
ASTM Reference Fuel A	NR	C		M	M			
ASTM Reference Fuel B	M	C		NR	M			
Barium Carbonate	M	C	M	C	M		C	C
Barium Chloride	M	C	C	C	C	C	C	C
Barium Cyanide		C	M	NR	C		C	M
Barium Hydroxide	C	C	M	C	C		C	NR
Barium Nitrate	NR	C	M	C	C		C	M
Barium Sulfate	M	C	M	C	C		C	M
Barium Sulfide	M	C	M	C	C	C	C	C
Benzaldehyde	NR	C	C	NR	NR	C	C	C
Benzene (Gasoline)	NR	C	NR	NR	NR	C	C	C
Benzenesulfonic Acid	NR	C	C	NR	NR		NR	
Benzoic Acid	NR	C	C	NR	C	C	NR	M
Benzol	NR	C	NR	NR	NR		NR	C
Benzyl Alcohol	NR	C	NR	NR	C	C	M	C
Boric Acid	C	C	C	M	C	C	M	C
Bromine	NR	C	NR	NR	NR	NR	NR	NR
Butadiene	NR	C	NR	NR	NR		M	C
Butane	C	C	NR	C	C	C	C	C
Butyl Acetate	NR	C	NR	NR	NR	C		
Butyl Alcohol	NR	C	C	C	C		NR	C
Butylene	NR	C	M	M	C		M	C
Butyric Acid	NR	C	NR	NR	NR		M	C
Calcium Bisulfide	NR	C	M	M	M	C	C	
Calcium Carbonate	M	C	M	C	C	C	C	C
Calcium Chloride	C	C	M	C	C	C	C	NR
Calcium Hypochlorite, 5%	NR	C	C	M	C	C		
Calcium Hydroxide	C	C	C	C	C	C	C	NR
Calcium Nitrate	M	C		C	C	C	C	NR
Calcium Oxide	NR	C	M	C	M		M	C
Calcium Sulfate	M	C	M	C	C	C	NR	NR
Carbon Bisulfide	NR	-	-	NR	C		C	C
Carbon Dioxide	C	C	C	C	NR	C		
Carbon Dioxide (Dry)	A	C	C	C	C	C	C	C
Carbon Dioxide (Wet)	NR	C	C	C	NR		C	C
Carbon Disulfide	NR	C	NR	NR	C		M	C
Carbon Monoxide	C	C	C	C	C	C	C	C
Carbon Tetrachloride	NR	C	NR	M	C	C	NR	M
Carbonic Acid	M	C	M	NR	C	C	C	M
Castor Oil	C	C		C	C			
Chlorinated Glue	NR	-	-	M	C	NR		NR
Chlorine	NR	C	NR	NR	C	NR	NR	C
Chloroacetic Acid	NR	C		NR	NR	C	NR	NR
Chlorobenzene (Mono)	NR	M	NR	NR	C	C	NR	NR
Chloroform	NR	C	NR	NR	C	C	C	C

**COMPATIBILITY RATING:** C .....Compatible    NR .....Not recommended    M .....Generally not recommended    PEEK® is a trademark of Victrex plc.  
<sup>1</sup> The Fluid Compatibility Guide is intended for use as a reference only. Actual testing should be conducted to determine the suitability of the material in the fluid and application. Results may vary significantly due to varying conditions including temperature, concentration, mixtures and other.

**FLUID COMPATIBILITY GUIDE<sup>1</sup>**

Fluid	PUR (EU)	PTFE (unfilled)	UHMW PE	NBR	FKM	PEEK®	Nylon (Nylon)	POM (Acetal)
Chlorosulfonic Acid	NR	C	NR	NR	NR	NR	NR	NR
Chromic Acid	NR	C	NR	NR	M	NR	NR	NR
Chromium Potassium Sulfate	M	C		M	M			
Citric Acid	M	C	NR	C	C	C	C	M
Clorox (Bleach)		C	-	NR	C	C	C	NR
Copper Chloride	NR	C	-	C	C	C	NR	C
Copper Cyanide	M	C	M	C	C	C	NR	C
Copper Fluoborate		-	-	NR	C			M
Copper Nitrate	NR	C	M	C	C	C	NR	C
Copper Sulfate 5%		C	C	C	C	C	NR	NR
Copper Sulfate >5%	NR	C	C	C	C	C	NR	NR
Cottonseed Oil	C	C		C	C			
Cresol (Meta)	NR	NR	NR	NR	M		NR	NR
Cresylic Acid	NR	C	M	NR	C		NR	NR
Cupric Chloride	C	C		NR	M			
Cupric Nitrate	M	C		M	M			
Cupric Sulfate	M	C		M	M	C		
Cyclohexanone	NR	C	NR	NR	NR	C	C	C
Cyclohexane	M	C	M	C	C	C	C	C
Detergents	NR	C	NR	M	C	C		C
Diacetone Alcohol	NR	C	M	NR	NR		C	C
Dibutyl Ether	M	C		NR	NR			
Dibutyl Phthalate	NR	C		NR	NR	C		
Dichloroethane	NR	C	NR	NR	NR	C	C	C
Diesel Fuel	NR	C	NR	C	C	C	C	NR
Diethyl Ether	M	C	-	NR	NR	C	C	
Diethylamine	NR	NR	NR	NR	NR	C	C	M
Diethylene Glycol	NR	C	M	C	C		C	C
Dimethyl Acetamide	NR	C						
Dimethyl Formamide	NR	NR	C	NR	NR	C	C	NR
Diphenyl Oxide	NR	C	-	NR	C			NR
Dodecyl Mercaptan	M	C						
Epson Salts	NR	C	C	C			C	M
Ethane	NR	C	-	C	C	C	NR	C
Ethanol	NR	C	M	NR	NR	C	C	C
Ethanolamine	NR	C	-	M	NR		C	NR
Ether	M	C	NR	NR	M		C	C
Ethyl Acetate	NR	C	NR	NR	NR	C	C	C
Ethyl Alcohol	NR	C	M	M			C	C
Ethyl Benzoate	NR	C	NR	NR	C			
Ethyl Bromide	NR	C		M	C			
Ethyl Chloride	NR	C	NR	C	C		C	C
Ethylene Chloride	NR	C	NR	C	C		C	C
Ethylene Chlorohydrin	NR	C	NR	NR	C		NR	NR
Ethylene Diamine	NR	C	C	NR	NR		NR	NR
Ethylene Dichloride	NR	C	NR	NR	NR		C	M
Ethylene Glycol	M	C	NR	C	C	C	C	M

Fluid	PUR (EU)	PTFE (unfilled)	UHMW PE	NBR	FKM	PEEK®	Nylon (Nylon)	POM (Acetal)
Ethylene Oxide	NR	C	C	NR	NR	C	C	NR
Fatty Acids	NR	C	NR	M	C	C	C	C
Ferric Chloride	M	C	C	C	C	M	C	NR
Ferric Nitrate	M	C	C	C	C	C	C	NR
Ferric Sulfate	NR	C	C	C	C	C	C	NR
Ferrous Chloride	M	C	C	C	C	C	NR	NR
Ferrous Sulfate	M	C	C	C	M	C	NR	NR
Fluorine	NR	NR	NR	NR	NR	NR	NR	NR
Fluoroboric Acid		C	C				NR	C
Fluosilicic Acid	NR	C	C	C	M		NR	C
Formaldehyde	NR	C		NR	NR	C		
Formaldehyde 40%	NR	C	NR	M	C	C	C	C
Formaldehyde 100%	NR	C	M	NR	NR	C	NR	C
Formic Acid	NR	C	NR	NR	NR	M	NR	C
Freon 11	NR	C	NR	NR	NR			
Freon 12	C	C	C	M	NR	C	C	M
Freon 22	NR	C	-	NR	NR	C	M	C
Freon 113	NR	C	-	C	NR	C		C
Freon Tf	NR	C	-	C	NR		NR	C
Fruit Juice	M	C	C	C	C	C	C	NR
Furfural	NR	C	NR	NR	NR		M	C
Gallic Acid	NR	M	C	NR	C		C	
Gelatin	NR	C	C	C	C	C	C	M
Glucose	NR	C	C	C	C		C	C
Glue, Pva	M	C	C	C	M		C	C
Glycerin	NR	C	C	C	C		C	C
Glycerine (Glycerol)	C	C		C	C	C		
Glycolic Acid	M	C	C	NR	NR			C
Propylene Glycol	M	C		M	C			M
Gasoline	M	NR	C	C	C	C	C	C
Greases	C	C	-	C	C			NR
<b>Hydraulics fluids (DIN 51524)</b>								
HETG (vegetable oil based) Environmentally acceptable fluids	C	C	C	C	C	C	C	C
HEES (synthetic ester based) Environmentally acceptable fluids	M	C		M	C	C	C	C
HEPG (polyglycol based) Environmentally acceptable fluids	M	C		M	M	C	C	C
<b>Hydraulics fluids (ISO 6743-4)</b>								
HL, HM, HV	C	C		C	C	C	C	C
HFA-E (5/95, oil - water emulsion) Fire resistant fluids	C	C		C	C	C	C	C
HFB (60/40, water-oil emulsion) Fire resistant fluids	NR	C		C	C	C	C	C
HFC (water/glycol) Fire resistant fluids	NR	C		NR	NR	C	C	C
HFD (pure synthetic fluids) Fire resistant fluids	NR	C		NR	NR	C	C	C
HFD-R (phosphate esters) Fire resistant fluids	NR	C		NR	C	C	M	M

**COMPATIBILITY RATING:** C .....Compatible    NR .....Not recommended    M .....Generally not recommended    PEEK® is a trademark of Victrex plc.  
<sup>1</sup> The Fluid Compatibility Guide is intended for use as a reference only. Actual testing should be conducted to determine the suitability of the material in the fluid and application. Results may vary significantly due to varying conditions including temperature, concentration, mixtures and other.

**FLUID COMPATIBILITY GUIDE<sup>1</sup>**

Fluid	PUR (EU)	PTFE (unfilled)	UHMW PE	NBR	FKM	PEEK®	Nylon (Nylon)	POM (Acetal)
Heptane	C	C	M	M	C	C	C	C
Hexane	C	C	NR	M	C	C	M	C
Hexyl Alcohol	NR	C	C	NR	NR		C	C
Hydrazine	NR	NR		NR	NR	C		M
Hydrobromic Acid	M	C		NR	C	NR		
Hydrobromic Acid 20%	NR	-	M	NR	C		NR	M
Hydrobromic Acid 100%	NR	C	M	NR	C	NR	NR	NR
Hydrochloric Acid	NR	C				C		
Hydrochloric Acid 20%	M	C	C	NR	C	C	NR	M
Hydrochloric Acid 100%	NR	C	-	NR	NR	C	NR	M
Hydrocyanic Acid	NR	C	C	NR	C	C	M	M
Hydrofluoric Acid 50%	NR	C	C	NR	M	NR	NR	NR
Hydrofluoric Acid	NR	C	-	NR	NR	NR	NR	NR
Hydrofluorosilicic Acid	NR	C	M	NR	C		NR	C
Hydrogen	M	C						
Hydrogen Gas	M	C	C	C	C		C	
Hydrogen Peroxide	M	C		M	C	C		
Hydrogen Sulfide	NR	C	C	NR	NR		M	M
Hydroiodic Acid	M	-						
Hydroquinone		C	C	NR	NR		N	C
Hydroxyacetic Acid 70%	NR	C	C	M	C			C
Iodine Solution	NR	C	C	M	C	M		NR
Isooctane	M	C		C	C	C	C	
Isobutyl Alcohol	NR	C	C	NR			C	C
Isopropyl Acetate	NR	C	M	NR	NR		M	NR
Isopropyl Alcohol	NR	C	C	M	M	C	NR	C
Isopropyl Ether	M	C	M	NR	NR		C	NR
Kerosene	M	C	NR	C	C	C	C	C
Ketones	NR	C	NR	NR	NR		C	NR
Lacquer Thinners	NR	C	C	NR	NR		C	NR
Lactic Acid	M	C	C	C	C	C	M	M
Lard	NR	C	C	C	C		C	C
Latex	NR	C	-	C	C		C	M
Lead Acetate	M	C	C	NR	NR	C	C	M
Lead Sulfamate		M	C	M	C		M	C
Ligroin	NR	C	C	C	C		NR	M
Lime	NR	C	C	C	C	C	C	M
Linseed Oil	M	C		M	M	C		
Magnesium Carbonate	NR	C	M	M	C			C
Magnesium Chloride	M	C	C	C	C	C	C	M
Magnesium Hydroxide	C	C	C	M	C	C	M	C
Magnesium Nitrate	NR	C	C	C	C		C	C
Magnesium Salts	M	C		C	C			
Magnesium Sulfate	NR	C	C	C	C	C	C	M
Malic Acid	NR	C	M	NR	C	C	C	C
Melamine	NR	C	-	NR	C		C	C
Mercuric Cyanide		M	C	C	C	C	C	

Fluid	PUR (EU)	PTFE (unfilled)	UHMW PE	NBR	FKM	PEEK®	Nylon (Nylon)	POM (Acetal)
Mercury	M	C	C	C	C	C	C	C
Methane	NR	C	-	C	C	C	C	C
Methanol	NR	C	C	NR	NR	C	M	C
Methyl Acetate	NR	C	M	NR	NR		C	M
Methyl Acrylate	NR	-	-	NR	NR			M
Methyl Alcohol	NR	C	C	NR	NR	C	M	C
Methyl Cellosolve	NR	C	-	NR	NR		M	NR
Methyl Chloride	NR	C	NR	NR	C	C	M	M
Methyl Dichloride		-	-	NR	M		M	NR
Methyl Ethyl Ketone	NR	C	M	NR	NR	C	C	M
Methyl Isobutyl Ketone	NR	C	NR	NR	NR		M	
Methyl Isopropyl Ketone	NR	C	NR	NR	NR		C	
Methylamine		C	C	M	NR			NR
Methylene Chloride	NR	C	NR	NR	NR	C	M	M
Mineral Oil	C	C		C	C	C		
Mineral Spirits	NR	C	M	C	C		C	C
Monoethanolamine	NR	C	NR	NR	NR		C	NR
Naphtha	NR	M	C	M	C	C	C	C
Naphthalene	M	C	NR	NR	C	C	C	C
Natural Gas	M	C		C	C	C		M
Nickel Chloride	NR	C	C	C	C	C	M	C
Nickel Salts	NR	C		C	C	C		
Nickel Sulfate	NR	C	C	C	C	C	C	C
Nitric Acid	NR	C		NR	NR	NR		
Nitric Acid 50%	NR	C	M	NR	C	NR	NR	NR
Nitrobenzene	NR	C	NR	NR	M	C	M	M
Nitrous Acid		C	-	NR	C			
Nitrous Oxide	NR	C	NR	C	C	C	M	
Octyl Alcohol	NR		C	NR	NR		C	C
Oleic Acid	M	C	NR	M	M	C	C	C
Oleum 25%	NR	C	NR	NR	M		NR	NR
Oleum 100%	NR	C	NR	NR	NR	NR	NR	NR
Oxalic Acid (5%)	C	C		M	C	C		
Oxygen	C	C		NR	C	C		
Ozone	C	C	C	NR	C	C	NR	M
Palmitic Acid	C	C		C	C		C	C
Paints	C-M	C		NR	NR			
Paraffin	M	C	M	M	M	C	C	C
Pentane	NR	C	NR	C	C	C	C	M
Perchloric Acid	NR	C	M	NR	C	C	NR	M
Perchloroethylene	NR	C	NR	M	C	C	M	M
Petrolatum	NR	NR	M	C	C		NR	M
Phenol (Carbolic Acid)	NR	C		NR	NR		NR	NR
Phosphoric Acid	NR	C	M	NR	C	C	M	NR
Phthalic Anhydride	M	C	-	NR	C	C	M	M
Picric Acid	NR	C	C	NR	C	C	M	C
Potash	NR	-	C	C	C		C	M

**COMPATIBILITY RATING:** C .....Compatible    NR .....Not recommended    M .....Generally not recommended    PEEK® is a trademark of Victrex plc.  
<sup>1</sup> The Fluid Compatibility Guide is intended for use as a reference only. Actual testing should be conducted to determine the suitability of the material in the fluid and application. Results may vary significantly due to varying conditions including temperature, concentration, mixtures and other.



**FLUID COMPATIBILITY GUIDE<sup>1</sup>**

Fluid	PUR (EU)	PTFE (unfilled)	UHMW PE	NBR	FKM	PEEK®	Nylon (Nylon)	POM (Acetal)
Potassium Bicarbonate	NR	C	C	C	C	C	C	M
Potassium Bromide	NR	C	C	C	C	C	C	C
Potassium Chlorate	M	C	C	C	C	C	M	M
Potassium Chloride	M	C	C	C	C	C	C	C
Potassium Chromate	NR	C	C	C	C		M	M
Potassium Cyanide	C	C	C	C	C		C	M
Potassium Dichromate	NR	C	C	C	C	C	M	C
Potassium Ferrocyanide	NR	C	C	NR	C	C	M	
Potassium Hydroxide	NR	C		NR	NR	C	M	C
Potassium Nitrate	M	C	M	C	C	C	M	C
Potassium Permanganate	NR	C	C	NR	C	C	NR	C
Potassium Salts	M	C		C	C			
Potassium Sulfate	M	C	C	C	C	C	C	M
Potassium Sulfide	M	C	C	C	C	C	C	
Propane	M	C	NR	C	C	C	C	C
Propyl Alcohol	NR	C	C	NR	C	C	NR	C
Propylene Glycol	NR	C	M	C	C		C	M
Pyridine	NR	C	M	NR	NR	C	M	M
Pyrogallic Acid	NR	C	-	NR	C			NR
Rosins	NR	C	M	C	C		C	M
Seawater	C	C	C	C	C		C	C
Shellac (Bleached)	NR	C	C	C	C		C	C
Silicic Acid	M	C		A	A	C		
Silicone		C	-	C	C	C	C	C
Skydrol Oil (500)	NR	C		NR	NR			
Silver Bromide		C	C	NR				M
Silver Nitrate	M	C	C	M	C	C	C	C
Soap	M	C	NR	C	C	C	C	C
Sodium Acetate	M	C	C	M	NR	C	M	M
Sodium Aluminate		C	-	C	C		C	M
Sodium Bicarbonate	M	C	C	C	C	C	C	C
Sodium Bisulfate	M	C	C	C	C		C	M
Sodium Borate	M	C	C	C	C		C	
Sodium Carbonate	M	C	M	C	C	C	M	C
Sodium Chlorate	M	C	M	M	C	C	NR	C
Sodium Chloride	M	C	C	C	C	C	C	C
Sodium Chromate		C	-	C	C		M	NR
Sodium Cyanide	M	C	C	C	C		C	C
Sodium Dichromate	M	C		A	A			
Sodium Ferrocyanide	M	C		C	C			C
Sodium Fluoride	M	C	C	C	C		M	
Sodium Hydrosulfite	M	C		NR	NR		C	
Sodium Hydroxide 20%		C	NR	C	NR	C	C	C
Sodium Hydroxide 45%	M	C			NR	C		
Sodium Hydroxide 50%		C	NR	NR	NR	C	C	C
Sodium Hydroxide 80%		C	NR	NR	NR		M	NR
Sodium Hypochlorite 5%	NR	C			NR	C	NR	NR

Fluid	PUR (EU)	PTFE (unfilled)	UHMW PE	NBR	FKM	PEEK®	Nylon (Nylon)	POM (Acetal)
Sodium Hypochlorite 100%	NR	C	M	M	C	C	NR	NR
Sodium Metaphosphate	NR	C	C	C	C		C	M
Sodium Metasilicate	NR	C	-	C	C			NR
Sodium Nitrate	M	C	C	NR	C	C	C	C
Sodium Perborate	NR	C	C	NR	C		M	M
Sodium Peroxide	NR	C	C	NR	C	C	C	NR
Sodium Polyphosphate		C	C	C	C		C	M
Sodium Silicate	M	C	C	C	C	C	C	M
Sodium Sulfate	M	C	C	C	C	C	C	M
Sodium Sulfide	M	C		C	C	C	C	M
Sodium Tetraborate	NR	C	C	C	C		C	M
Sodium Thiosulfate (Hypo)		C	C	M	C		M	M
Soybean Oil	M	C		C	C			
Stannic Chloride	NR	C	C	C	C	C	M	M
Stannous Chloride	NR	C	M	C	C	C	M	
Starch	A	C	M	C	C	C	C	C
Steam	NR	C		NR	NR	C		
Stoddard Solvent	NR	C	NR	C	C		C	C
Styrene	M	C	-	NR	M		C	C
Sugar (Liquids)		C	-	C	C		C	C
Sulfate (Liquors)	NR	C	C	NR	C		M	NR
Sulfur Chloride	NR	C	NR	NR	C	C	C	NR
Sulfur Dioxide	NR	C		NR	C	C	M	M
Sulfur Dioxide (Dry)	NR	C	C	NR	C		M	M
Sulfur Hexafluoride	NR	-	M	NR	NR	C	M	
Sulfur Trioxide	NR	C	-	NR	C	C	NR	
Sulfur Trioxide (Dry)	NR	C	NR	NR	C		C	NR
Sulfuric Acid 10-50%	NR	C		NR	NR	M		
Sulfuric Acid 10-75%	NR	C	C	NR	NR	NR	NR	NR
Sulfuric Acid 75-100%	NR	C	M	NR	NR	NR	NR	
Sulfuric Acid <10%	NR	C	C		C	M	M	NR
Sulfuric Acid (Cold Conc)		C	NR		C		NR	
Sulfuric Acid (Hot Conc)		C	NR		C		NR	
Sulfurous Acid	NR	C	M	NR	M	C	NR	M
Tallow	A	C	NR	C	C	C	C	C
Tannic Acid 10%	C	C		C	C	C		
Tanning Liquors	NR	C	C	NR	C		C	M
Tartaric Acid	C	C	C	C	C	C	M	M
Tetrachloroethane	NR	C	-	NR	C		M	C
Tetrachloroethylene	NR	C	M	NR	C		C	C
Tetrahydrofuran	NR	C	NR	NR	NR	C	C	C
Tin Salts	M	C	-	C	C			
Titanium Salts	M	-		NR	M			
Toluene	NR	C	NR	NR	C	C	C	M
Transformer Oil	M	C		C	C	C		
Trichloroacetic Acid	NR	C	C	NR	NR		M	
Trichloroethane	NR	C	-	NR	C	C	M	C

**COMPATIBILITY RATING:** C .....Compatible    NR .....Not recommended    M .....Generally not recommended    PEEK® is a trademark of Victrex plc.  
<sup>1</sup>The Fluid Compatibility Guide is intended for use as a reference only. Actual testing should be conducted to determine the suitability of the material in the fluid and application. Results may vary significantly due to varying conditions including temperature, concentration, mixtures and other.

**FLUID COMPATIBILITY GUIDE<sup>1</sup>**



Fluid	PUR (EU)	PTFE (unfilled) PE	UHMW PE	NBR	FKM	PEEK®	Nylon (Nylon)	POM (Acetal)
Trichloroethylene	NR	C	NR	NR	C	C	M	NR
Trichloropropane	M	C	-	NR	M			C
Tricresyl Phosphate	NR	C	M	NR	M		C	M
Triethanol Amine	M	C		NR	NR			NR
Trisodium Phosphate	M	C	C	C	C		M	C
Turpentine	NR	C	NR	C	C	C	M	C
Urea	M	C	C	NR	C	C	C	C
Uric Acid	NR	C	M	NR			C	
Varnish	M	C	C	M	C	C	C	C
Vegetable Oil	C	C		C	C	C		
Vinegar	NR	C	C	M	NR	C	C	M
Water	C	C	C	C	M	C	C	C
Water Acid, Mine	NR	C	C	C	C		C	C
White Liquor	NR	C	C	C	C		C	NR
Xylene	NR	C	M	NR	C	C	C	C
Xylol	NR	C		NR	C			
Zinc Chloride	M	C	C	C	C	C	C	M
Zinc Sulfate	M	C		C	C	C	C	M

**COMPATIBILITY RATING:** C .....Compatible    NR .....Not recommended    M .....Generally not recommended

<sup>1</sup> The Fluid Compatibility Guide is intended for use as a reference only. Actual testing should be conducted to determine the suitability of the material in the fluid and application. Results may vary significantly due to varying conditions including temperature, concentration, mixtures and other.

PEEK® is a trademark of Victrex plc.

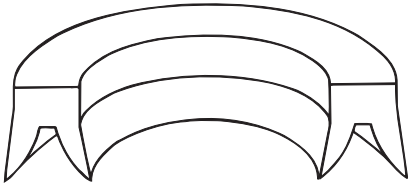
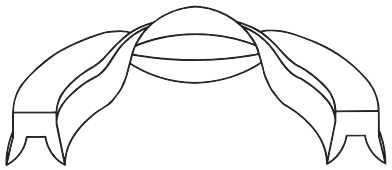
*This section provides troubleshooting criteria for Chesterton's hydraulic and pneumatic sealing devices. It should be used only as a general reference guide when repacking, rebuilding, or redesigning any cylinder or press and specific guidance can be provided by your Chesterton representative. By installing superior, longer lasting seals and components in a properly designed cylinder, one can expect greatly extended, leak-free service.*

SEAL CONDITION	No visible damage, but leaking	
	Probable Cause	Possible Solution
	Incorrect size seal not sealing dynamically or statically.	Check seal and equipment dimensions. Check for additional causes of leak such as static O-ring or gasket leak.
	Hydroplaning due to low sealing pressure with high viscosity fluid and too smooth surface finish.	Check fluid pressure on return to tank cycle. Check dynamic surface finish. Check cycle speed. Consider alternate seal design with higher pre-load.
SEAL CONDITION	Rolled or twisted seal may have permanent creases from twisting in seal cavity and may be severely rolled	
	Probable Cause	Possible Solution
	A variety of conditions may cause rolling of a seal. Drag due to sizing problem, vacuuming, extrusion, or swelling may all cause seals to roll. In addition, side loading and shock loading could be contributing factors.	Check dimensions of seal and equipment. Check system and application for operating condition. Look for other types of damage to help troubleshoot this problem.
SEAL CONDITION	Seal lips are crushed, crimped or creased	
	Probable Cause	Possible Solution
	Seal too tall for groove.	Remachine seal groove or choose shorter seal.
	Loose bottom bushing under seal hits seal when pressurized.	Secure and vent bottom bushing.
	Seal is being mechanically loaded by a metallic or elastomeric retaining device.	Remove device if not necessary or re-work device to prevent contact with seal lip(s).
	Seal is being dragged to bottom of groove or box by vacuum or by missing of seal.	Correct vacuum condition or secure seal with retaining device. Check seal dimensions and correct application of piston and rod designed seals.
	Piston cup lip is jammed by hold down plate on piston or is acting as stop at end or stroke.	Correct inside ("d2" dimension) of piston cup relative to diameter of hold down plate. Provide mechanical stop on stroke or choose cup with shorter lip.

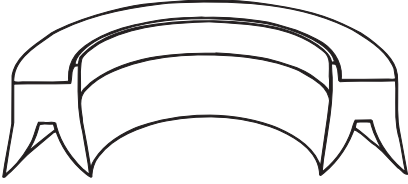
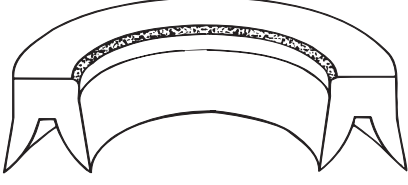
SEAL CONDITION	Extrusion of inside diameter heel	
	Probable Cause	Possible Solution
	<p>If extrusion is evident all around circumference of inside diameter heel, rod or ram to gland or bushing clearance is excessive for pressure.</p>	<p>Rework or replace gland or bushing to achieve recommended clearance. Use rigid back-up ring.</p>
	<p>If extrusion is evident on half of the circumference of the inside diameter heel, rod or ram is side loading. Gland may not be centered or cylinder head may be cocked.</p>	<p>Rework or replace gland or bushing. Replace bearings. Use backup ring. Check gland for centering.</p>

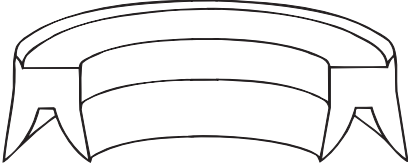
SEAL CONDITION	Extrusion of outside diameter heel	
	Probable Cause	Possible Solution
 <p data-bbox="228 1115 418 1136">A. Piston Application</p>	<p>A1: If extrusion is evident all around circumference of outside diameter heel, piston head-to-bore clearance is excessive. May be due to poor design, wear, or pressure swelling or "ballooning."</p>	<p>A1: Rework or replace piston head or retube to achieve recommended clearance. Use non-metallic bearing band(s) to prevent wear. Check cylinder integrity relative to maximum pressure. Use back-up rings under extreme shock loads.</p>
	<p>A2: If extrusion is evident on half of the circumference of the outside diameter heel, piston is side loading or cylinder is out-of-round.</p>	<p>A2: Rework piston head for non-metallic bearing band thus centering piston. Check cylinder bore for possible ovality.</p>

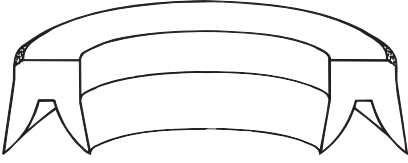
 <p data-bbox="220 1457 427 1478">B. Rod Seal Application</p>	<p>B: Excessive clearance between gland and stuffing box bore.</p>	<p>B: Rework or replace gland or use back-up ring.</p>
--	--	--

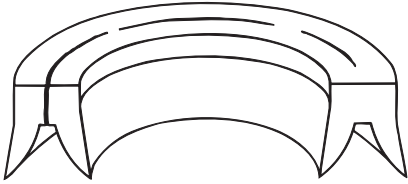
SEAL CONDITION	U-cup split through center of its cross-section	
	Probable Cause	Possible Solution
	<p>If splitting or separation is apparent over most or all of seal's circumference, the cause is a dial oversizing or incorrect seal size.</p>	<p>Check equipment dimensions and compare to seal dimension.</p>

SEAL CONDITION	U-cup or piston cup lip is separated from heel	
	Probable Cause	Possible Solution

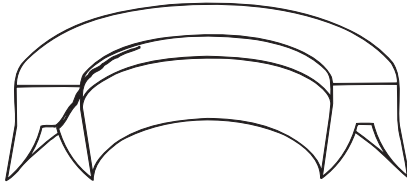

If splitting or separation is apparent over a small portion of seal's circumference, the cause is a lack of concentricity or ovality of equipment.

Rework or replace bearing support to achieve concentricity of rod and piston. Check stuffing box and cylinder bores for roundness.

SEAL CONDITION	Crescent shaped section missing from dynamic sealing lip	
	Probable Cause	Possible Solution

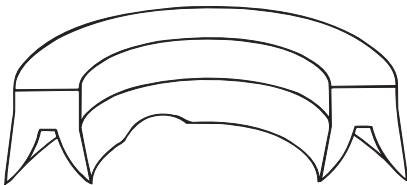

Piston seal lip is passing over port either during installation or actual use.

Chamfer sharp internal port edges, alter stroke or piston design to avoid port. If caused during installation, use shim or otherwise protect seal from sharp edges.

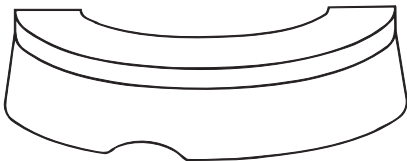

Seal lip was kinked, jammed, or curled back during installation.

Use care when installing. Don't use sharp tools. Check lip before pushing into bore.

SEAL CONDITION	Excessive abrasion or grooving of dynamic sealing lip	
	Probable Cause	Possible Solution

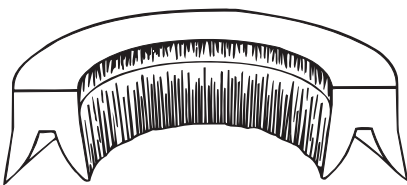

A. Rod Seal Application

A1: Excessive wear on inside diameter indicates poor rod finish.

A1: Rework or replace rod or ram to achieve finish of 8 – 24 R.M.S (Ra).

A2: Excessive wear on inside diameter indicates abrasive particles in the system.

A2: Install sharp lip, abrasion resistant wiper. Consider an externally mounted, easily replaceable wiper. May require a custom wiper in excessively wet/dirty environments.

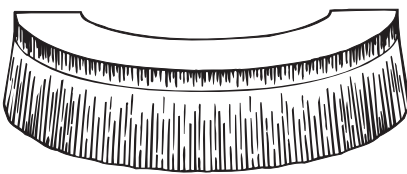

B. Piston Application

B1: Excessive wear on outside diameter indicates poor bore finish.

B1: Rework or replace cylinder tube to a bore finish of 8 – 24 R.M.S (Ra).

B2: Excessive wear on outside diameter indicates abrasive particles in the system.

B2: Check condition of fluid. Filter system with portable filtration or drain and flush system.

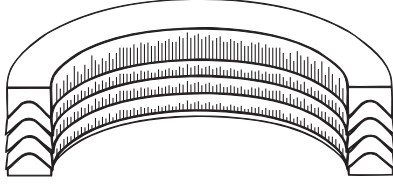
SEAL CONDITION	Excessive wear, misshaping, darkening of V-ring sets in stacked sets	
	Probable Cause	Possible Solution
	<p>Undercompression of stacked V-ring set can cause rings to roll or twist and bind causing leakage and excessive friction.</p>	<p>Check split if applicable, check alignment of each ring before installing next ring.</p>
	<p>Overcompression of stacked V-ring set can cause binding and excessive friction due to lack of lubricating barrier and additional drag.</p>	<p>Measure equipment and seal set carefully; shim and adjust properly. If ram or rod is binding, loosening of load on set may ease binding. May need to remove and re-pack V-rings properly.</p>

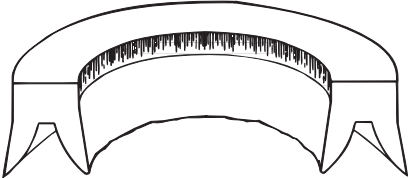
SEAL CONDITION	Wear on dynamic heel 360° of seal's circumference	
	Probable Cause	Possible Solution
	<p>Misapplication of rod or piston designed seal or wrong seal size.</p>	<p>Use rod seals for rod applications and piston mounted seals on pistons. Check equipment and seal dimensions.</p>

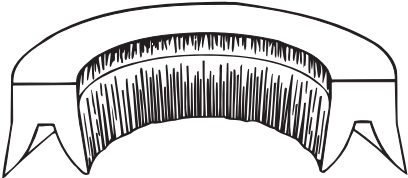
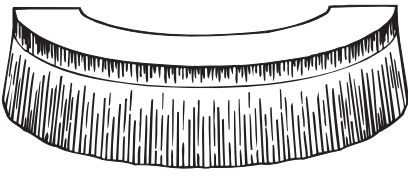
SEAL CONDITION	Excessive wear on dynamic heel and lip of 180° of seal's circumference. May also show extrusion of dynamic heel 180° opposite of the worn side of the seal	
	Probable Cause	Possible Solution
 <p data-bbox="219 1354 430 1375">A. Rod Seal Application</p>  <p data-bbox="235 1591 414 1612">B. Piston Application</p>	<p>Side loading due to misalignment, mounting and clevis design or application and design causing bushing and bearing wear and excessive seal wear. Also increases clearances resulting in possible extrusion.</p>	<p>Re-work or replace bearing or bushing to achieve concentricity. Check for misalignment or cause of side loading. Increase bearing area with strong, non-metallic bearings. Check diametral clearances for adequate seal support.</p>

**SEAL CONDITION** Excessive wear on heel 360° of circumference of piston cup, often the seal lip will not show wear

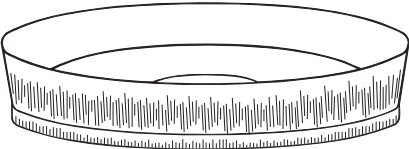
	Probable Cause	Possible Solution
	<p>Overcompression of the piston cup due to overtightening of the hold down plate or base thickness too great for the available space causes the heel to squeeze-out.</p>	<p>Compress flange thickness (H2)10%. Check base thickness relative to space available. Do not overtighten. Check cup visually after tightening for heel squeeze-out.</p>

**SEAL CONDITION** Vertical/Axial scratches on static lip may be associated with other damage

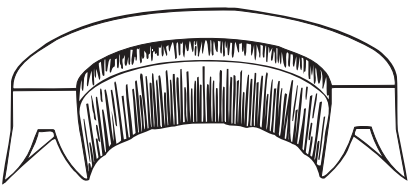
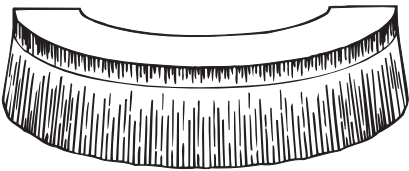
	Probable Cause	Possible Solution
 <p>A. Piston Application</p>	<p>Incorrect sizing of rod or piston seal will cause seal to move axially in the seal groove/stuffing box. Axial movement is evident due to scratches on static lip.</p>	<p>Check dimensions of seal groove/stuffing box and rod or bore diameter. Check for seal fit and correct application of rod seal or piston mounted seal.</p>
 <p>B. Rod Seal Application</p>	<p>Vacuuming due to inability of fluid to fill cylinder to make up for increasing volumetric area.</p> <p>A: Excessive wear or “pock-marked” appearance on <i>outside</i> diameter indicates a poor static finish on box bore or seal groove.</p> <p>B: Excessive wear or “pock-marked” appearance on <i>inside</i> diameter indicates a poor static finish on piston seal groove.</p>	<p>Correct shock-loading if possible. Check system for pipe flow volume. Consider alternate seal design.</p> <p>A: Re-work to achieve a static finish 32 – 45 R.M.S. (Ra).</p> <p>B: Re-work to achieve a static finish 32 – 45 R.M.S. (Ra).</p>

**SEAL CONDITION** Discoloration, swelling, softening, or hardening of seal compound

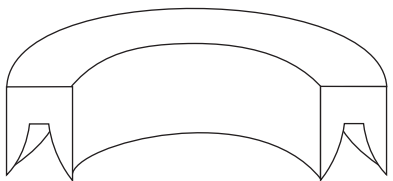
	Probable Cause	Possible Solution
	<p>Fluid incompatibility with hydraulic fluid, lubricating oil, installation grease, or cleaning solvent.</p>	<p>Check compatibility of seal compound. Change fluid type or substitute seal compound.</p>

**SEAL CONDITION**      **Black, tar-like deposits and/or burned spots, possibly burned completely through the heel of the seal. This damage will appear in the crotch area between the seal lips.**

**Probable Cause**      **Possible Solution**

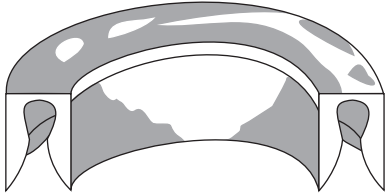

Dieseling, due to auto ignition of hydraulic fluid causing intense heat at the damaged area. Dieseling results from trapped air bubbles in the fluid rising to settle between the seal lips where, under pressure, the bubbles are compressed. Rapid decompression of compressed air bubble results in energy released as heat.

Bleed all air from hydraulic system. Caution should be used to bleed system after any work is done to pump, valves, lines, or actuators.

**SEAL CONDITION**      **Seal is dark or black in color, has lost flair or is drastically misshaped**

**Probable Cause**      **Possible Solution**

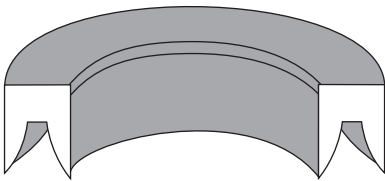

Darkening of entire seal indicates excessive fluid temperatures or environmental heat exposure.

Protect against environmental heat source. Maintain or utilize cooling system. Use high temperature seal compound.

Darkening of dynamic lip only indicates excessive friction due to speed, lack of lubricity, or jamming of dynamic lip or heel.

Check reciprocating or rotating speed. Check lubrication of pneumatic system or lubricity of hydraulic fluid. Look for evidence of jamming of lip or extrusion of heel.

Drastically misshaped seal indicates prolonged exposure to heat or extremely high heat. May be caused by continual rolling of seal in groove.

Use high temperature seal compound. Check seal groove dimensions.



# Engineering Action Request Form

**CONTACT INFORMATION**

Name \_\_\_\_\_ Date \_\_\_\_\_  
 Company \_\_\_\_\_ Address \_\_\_\_\_  
 Telephone \_\_\_\_\_ e-mail \_\_\_\_\_  
 Customer \_\_\_\_\_

**New Tooling Only (Fill out profile and material below)**

Seal Profile or Description \_\_\_\_\_ Material \_\_\_\_\_

**OPERATING CONDITIONS**

static     
  reciprocating     
  rotary     
  oscillating

Pressure: psi <input type="checkbox"/> bar <input type="checkbox"/> Operating _____ Min _____ Max _____ Direction: <input type="checkbox"/> Unidirectional pressure <input type="checkbox"/> Bidirectional pressure Vacuum: Yes <input type="checkbox"/> No <input type="checkbox"/>	Speed: ft/min <input type="checkbox"/> m/s <input type="checkbox"/> Stroke length _____ Cycles/min _____  RPM _____	Temperature: C <input type="checkbox"/> F <input type="checkbox"/> Continuous _____ Min _____ Max _____	Media _____ Gas <input type="checkbox"/> Liquid <input type="checkbox"/>  Name _____
---	---	--	---

Describe existing seal problem or expectation: \_\_\_\_\_  
 \_\_\_\_\_  
 \_\_\_\_\_

Describe existing seal design and material: \_\_\_\_\_  
 \_\_\_\_\_  
 \_\_\_\_\_

**EQUIPMENT**

Application \_\_\_\_\_ Surface finish \_\_\_\_\_ Ra  RMS   
 Manufacturer \_\_\_\_\_ Hardness \_\_\_\_\_ Rc   
 Model \_\_\_\_\_ Plating/Coating \_\_\_\_\_  
 Misalignment \_\_\_\_\_ in \_\_\_\_\_ mm Eccentricity (T.I.R.) \_\_\_\_\_ in \_\_\_\_\_ mm  
 (shaft to bore) or Run-out

*See reverse side for equipment dimensioning.*

Describe application and/or operating conditions: \_\_\_\_\_  
 \_\_\_\_\_  
 \_\_\_\_\_

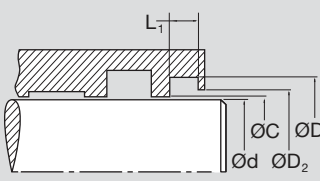
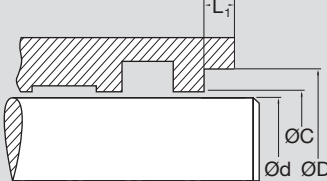
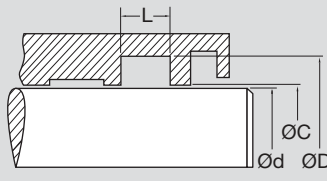
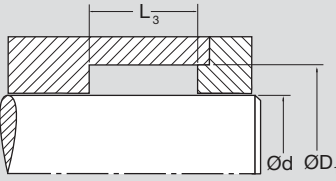
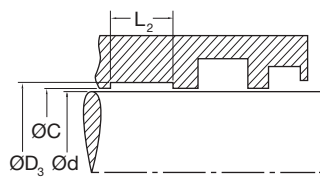
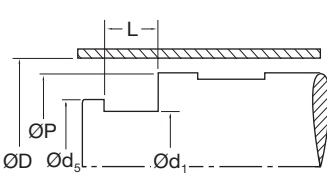
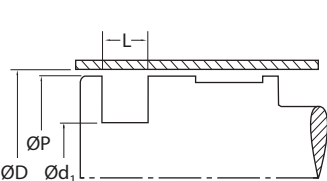
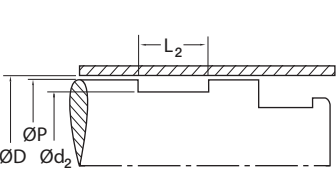
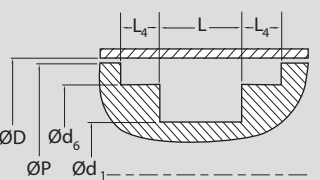
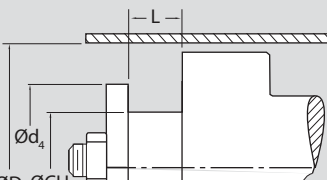
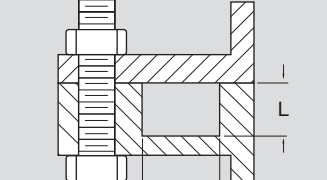
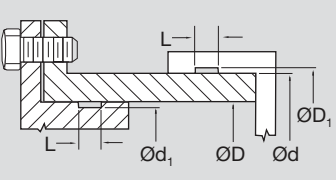
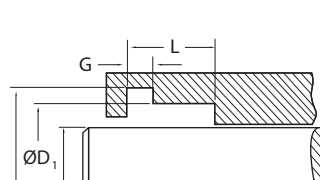
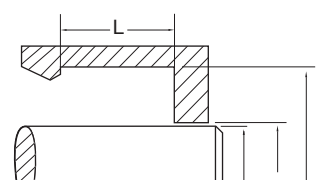
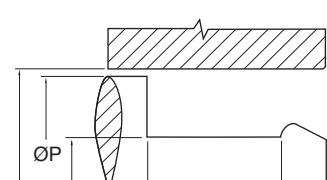
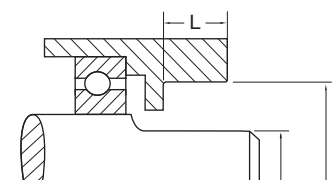
<p><b>Rod Wiper</b></p>  <p> <math>\text{OD:}</math> _____ <math>\text{OD}_4:</math> _____  <math>\text{OC:}</math> _____ <math>L_1:</math> _____  <math>\text{OD}_2:</math> _____                 </p>	<p><b>Canned Rod Wiper</b></p>  <p> <math>\text{OD:}</math> _____ <math>\text{OD}_4:</math> _____  <math>\text{OC:}</math> _____ <math>L_1:</math> _____                 </p>	<p><b>Rod Seal</b></p>  <p> <math>\text{OD:}</math> _____ <math>\text{OD}_1:</math> _____  <math>\text{OC:}</math> _____ <math>L:</math> _____                 </p>	<p><b>Rod Packing</b></p>  <p> <math>\text{OD:}</math> _____ <math>L_3:</math> _____  <math>\text{OD}_1:</math> _____                 </p>
<p><b>Rod Wear Ring</b></p>  <p> <math>\text{OD:}</math> _____ <math>\text{OD}_3:</math> _____  <math>\text{OC:}</math> _____ <math>L_2:</math> _____                 </p>	<p><b>Piston Seal U-Cup</b></p>  <p> <math>\text{OD}_1:</math> _____ <math>\text{OP}</math> _____  <math>\text{OD}_5:</math> _____ <math>L:</math> _____  <math>\text{OD:}</math> _____                 </p>	<p><b>Piston Bidirectional Seal</b></p>  <p> <math>\text{OD}_1:</math> _____ <math>\text{OP:}</math> _____  <math>\text{OD:}</math> _____ <math>L:</math> _____                 </p>	<p><b>Piston Wear Ring</b></p>  <p> <math>\text{OD:}</math> _____ <math>\text{OP:}</math> _____  <math>\text{OD}_2:</math> _____ <math>L_2:</math> _____                 </p>
<p><b>Bidirectional Piston Seal</b></p>  <p> <math>\text{OD}_1:</math> _____ <math>\text{OP:}</math> _____  <math>\text{OD:}</math> _____ <math>L:</math> _____  <math>\text{OD}_6:</math> _____ <math>L_4:</math> _____                 </p>	<p><b>Piston Cup Seal</b></p>  <p> <math>\text{OD:}</math> _____ <math>\text{OC:}</math> _____  <math>\text{OD}_4:</math> _____ <math>L:</math> _____                 </p>	<p><b>Face Seal</b></p>  <p> <math>\text{I.D.:</math> _____ <math>L:</math> _____  <math>\text{O.D.:</math> _____                 </p>	<p><b>O-Ring Gland</b></p>  <p>                     Piston Mount    Rod Mount  <math>\text{OD:}</math> _____ <math>\text{OD}_1:</math> _____  <math>\text{OD}_1:</math> _____ <math>\text{OD:}</math> _____  <math>L:</math> _____ <math>L:</math> _____                 </p>
<p><b>Flanged Shaft Seal Gland</b></p>  <p> <math>\text{OD}_1:</math> _____ <math>G:</math> _____  <math>\text{OD:}</math> _____ <math>L:</math> _____  <math>\text{OD}_5:</math> _____                 </p>	<p><b>Rod Seal Rotary</b></p>  <p> <math>\text{OD}_1:</math> _____ <math>L:</math> _____  <math>\text{OD:}</math> _____  <math>\text{OC:}</math> _____                 </p>	<p><b>Piston Seal Rotary</b></p>  <p> <math>\text{OD:}</math> _____ <math>\text{OP:}</math> _____  <math>\text{OD}_1:</math> _____ <math>L:</math> _____                 </p>	<p><b>Rotary Shaft Seal</b></p>  <p> <math>\text{OD:}</math> _____ <math>L:</math> _____  <math>\text{OD:}</math> _____                 </p>

# PRODUCT INDEX

PRODUCT	TYPE	PAGE
<b>5K</b>	Wiper	8, <b>14</b> , 52
<b>6K</b>	Rod Seal	8, <b>20</b> , 53
<b>7K</b>	Rod and Piston Seal	8, <b>26</b> , 58
<b>8K</b>	Rod and Piston Seal	8, <b>22</b> , 54, 57
<b>9K</b>	Anti-Extrusion Rings	8, <b>28</b> , 59
<b>10K</b>	Rod and Piston Seal	8, <b>16</b> , 53, 56
<b>11K</b>	Rod Seal	8, <b>21</b> , 54
<b>14K</b>	Restriction Bushings	<b>39</b> , 60
<b>16K</b>	Bearing Band Strips	8, <b>29</b> , 59
<b>17K</b>	Bearing Band Strips	8, <b>29</b> , 59
<b>18K</b>	Bearing Bands	8, <b>30</b> , 59
<b>19K</b>	Bearing Bands	8, <b>30</b> , 59
<b>20K</b>	Rod and Piston Seal	8, <b>24</b> , 55, 58
<b>20KD</b>	Face and Static Seal	8, <b>27</b> , 55, 58
<b>21K</b>	Wiper	8, <b>14</b> , 52
<b>21K</b>	Canned Wiper	8, <b>15</b> , 52
<b>22K</b>	Rod and Piston Seal	8, <b>17</b> , 53, 56
<b>22KE</b>	Rod and Piston Seal	8, <b>18</b> , 53, 56
<b>22KN</b>	Rod and Piston Seal	8, <b>16</b> , 53, 56
<b>23K</b>	Rod and Piston Seal	8, <b>19</b> , 53, 56
<b>27K</b>	Rod and Piston Seal	8, <b>22</b> , 54, 57
<b>30K</b>	Bearing and Gearbox Protection	8, <b>36</b> , 60
<b>30KC</b>	Viscous Fluids and Powders	<b>38</b> , 60
<b>33K</b>	Bearing and Gearbox Protection	8, <b>37</b> , 60
<b>600</b>	Rod Seal	8, <b>23</b> , 54
<b>100 Series</b>	Cantilever Spring Design	8, <b>40</b> , 61
<b>200 Series</b>	Elliptical Coil Spring Design	8, <b>41</b> , 61
<b>300 Series</b>	Helical Wound Spring Design	8, <b>42</b> , 62
<b>400 Series</b>	Rotary Seals	8, <b>43</b> , 62
<b>500 Series</b>	Stacked V-Ring Seal	8, <b>44</b> , 62
<b>CCS</b>	Rod and Piston Seal	8, <b>25</b> , 55, 58
<b>WR</b>	Custom Wear Rings	8, <b>31</b> , 59







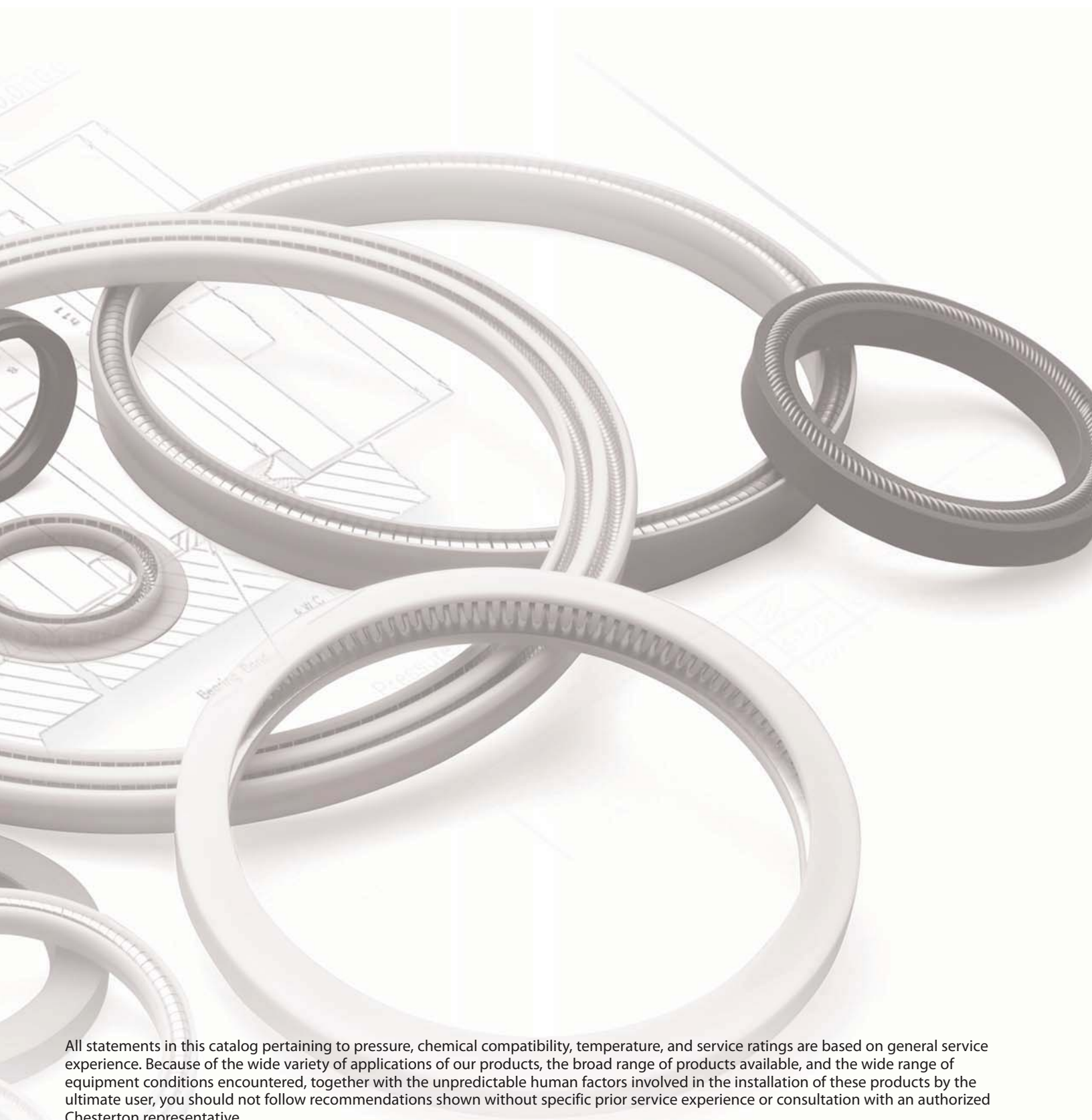

All statements in this catalog pertaining to pressure, chemical compatibility, temperature, and service ratings are based on general service experience. Because of the wide variety of applications of our products, the broad range of products available, and the wide range of equipment conditions encountered, together with the unpredictable human factors involved in the installation of these products by the ultimate user, you should not follow recommendations shown without specific prior service experience or consultation with an authorized Chesterton representative.

Specific data on materials, construction methods, installation, and troubleshooting procedures are subject to change without notice.

Performance is closely associated with the process operating conditions and equipment conditions. Technical data reflects results of laboratory tests and is intended to indicate general characteristics only. A.W. CHESTERTON COMPANY DISCLAIMS ALL WARRANTIES EXPRESSED, OR IMPLIED, INCLUDING WARRANTIES OF MERCHANTABILITY AND FITNESS FOR A PARTICULAR PURPOSE OR USE. LIABILITY, IF ANY, IS LIMITED TO PRODUCT REPLACEMENT ONLY.



## GLOBAL SOLUTIONS, LOCAL SERVICE

Since its founding in 1884, A.W. Chesterton Company has successfully met the critical needs of its diverse customer base. Today, as always, customers count on Chesterton solutions to increase equipment reliability, optimize energy consumption, and provide local technical support and service wherever they are in the world.

Chesterton's global capabilities include:

- Servicing plants in over 100 countries
- Global manufacturing operations
- More than 500 Service Centers and Sales Offices worldwide
- Over 1200 trained local Service Specialists and Technicians

Visit our website at  
[www.chesterton.com](http://www.chesterton.com)

Chesterton ISO certificates available on [www.chesterton.com/corporate/iso](http://www.chesterton.com/corporate/iso)

Technical data reflects results of laboratory tests and is intended to indicate general characteristics only.  
A.W. CHESTERTON COMPANY DISCLAIMS ALL WARRANTIES EXPRESSED, OR IMPLIED, INCLUDING WARRANTIES OF MERCHANTABILITY AND FITNESS FOR A PARTICULAR PURPOSE OR USE. LIABILITY, IF ANY, IS LIMITED TO PRODUCT REPLACEMENT ONLY.  
ANY IMAGES CONTAINED HEREIN ARE FOR GENERAL ILLUSTRATIVE OR AESTHETIC PURPOSES ONLY AND ARE NOT INTENDED TO CONVEY ANY INSTRUCTIONAL, SAFETY, HANDLING OR USAGE INFORMATION OR ADVICE RESPECTING ANY PRODUCT OR EQUIPMENT. PLEASE REFER TO RELEVANT MATERIAL SAFETY DATA SHEETS, PRODUCT DATA SHEETS AND/OR PRODUCT LABELS FOR SAFE USE, STORAGE, HANDLING AND DISPOSAL OF PRODUCTS OR CONSULT WITH YOUR LOCAL CHESTERTON REPRESENTATIVE.



DISTRIBUTED BY:

860 Salem Street  
Groveland, MA 01834 USA  
Telephone: 781-438-7000  
Fax: 978-469-6528  
[www.chesterton.com](http://www.chesterton.com)

© A.W. Chesterton Company, 2010. All rights reserved.  
® Registered trademark owned and licensed by  
A.W. Chesterton Company in USA and other countries.

FORM NO. EN75558

PRINTED IN USA 5/10