

# CODE

## PREMIUM HEATING

Code Premium **Horizontal** range has been designed in New Zealand by industry professionals to **represent outstanding quality and a timeless design to compliment all bathrooms**

### PRODUCT INTRODUCTION

**Tube shape:** Round or Square

**Finishes available:**

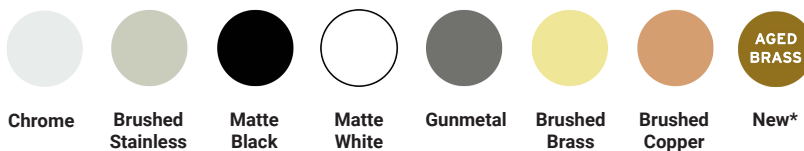

**Voltage/ Wattage:** All 12 Volt

#### ARC

482mm: 9.3 Watts  
632mm: 13.4 Watts  
832mm: 16.9 Watts

#### FLOW

490mm: 9 Watts  
640mm: 12 Watts  
840mm: 16 Watts

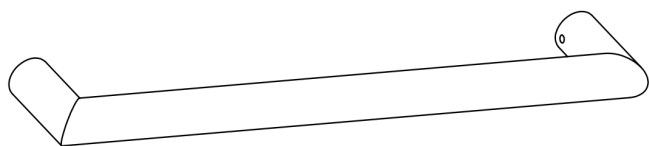

SR-ARO482 / 632 / 832

482mm, 632mm, 832mm (Outer edge)

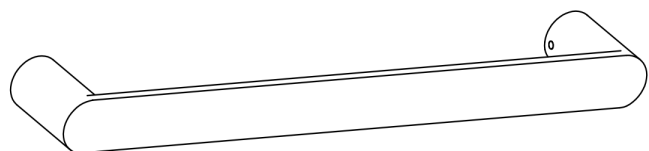

SR-FLOW490 / 640 / 840

490mm, 640mm, 840mm (Outer edge)

**Wiring:** Universal, cable can enter left or right.

For 1 x Rail – Use 1 x (ET70) TRANSFORMER – 0W–70W This transformer is small enough to fit through and sit behind a standard switch plate.

For 2 x Rails in one Location – Use 1 x (ET105) TRANSFORMER – 35W–105W This transformer is small enough to fit through and sit behind a standard switch plate.

For 3 x Rails in one location – Use 1 x (ET105) TRANSFORMER – 35W–105W This transformer is small enough to fit through and sit behind a standard switch plate.

For 4 x Rails in one location – Use 2 x (ET105) TRANSFORMER – 35W–105W (1 x per 2 rails) These transformers are small enough to fit through and sit behind a standard switch plate.

For 4 x Rails in one Location – You can use 1 x (XLG-150-12-A) TRANSFORMER- CODE 12V – LARGE – SLVR This cannot fit behind a standard switch plate and must be accessible for future service – This large transformer can be located nearby inside a vanity, cupboard or in the ceiling cavity max distance of 3.5mtrs from the rails.

**Standards:** Manufactured and tested to AS/NZS 60335.2.43

**Warranty:** 5 Years Domestic Warranty , 3Year Commercial Warranty

**IP Rating:** SR-ARO 482, 632, 832 – IP55; SR-FLOW 490, 640, 840 – IP55

# Safety Information

Please follow the basic safety instructions when you use our electric heated towel rail products.

**READ THESE INSTRUCTIONS CAREFULLY.** Keep them handy for future reference.

- This appliance is used for warming and drying towels, therefore it is hot to touch. Young children should be supervised when the product is working to ensure that they do not touch the appliance.
- The appliance will feel hotter to touch during Summer periods because of the rise in ambient temperature. The insulation effect of towels will cause the operating temperature to increase.
- The appliance should be installed so that switches and other controls cannot be touched by a person in the bath or shower.
- This appliance is **ONLY** used for warming and drying towels, **DO NOT** use it for any other purpose.
- To avoid danger this product **MUST NOT** be used to carry towels or any other articles that have been in contact with oil, petroleum based products or dry cleaning fluids.
- Make sure the voltage complies with the specification on the rating label, or elsewhere in these instructions.
- For your safety and others, make sure the electrical work is done by an authorized person according to AS/NZS3000:2000 Wiring Rules and Regulations.

1



- **DO NOT** immerse in any liquid.
- **DO NOT** allow the power cord to make contact with any hot surface when it is working.

2



- Check the product thoroughly **BEFORE** installation. If there is a problem bring it to the attention of the wholesaler immediately.

3

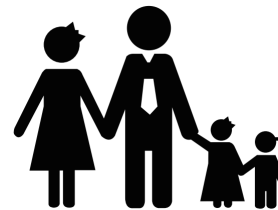

- **WARNING:** The bottom rail of this product **MUST** be installed at least 600mm above the floor in order to avoid risk of harm to young children.

# Care Instructions

**NOTE:** Damage caused by improper use or negligent cleaning is not covered by warranty – refer to the warranty terms & conditions



Every 3 weeks use a soft, clean cloth moistened with warm soapy water to clean off debris.

Fine scratches in the Chrome (only) finish can be removed with Autosol or Brasso paste, both of which are available from supermarkets and car care outlets throughout New Zealand.

Fingerprints can be removed by using a dry, soft microfibre cloth

**DO NOT** clean with any corrosive or abrasive cleaning agents including Steel wool/ scourers.

**DO NOT** use any cleaning agents containing acids or Bleach.

## Warranty Conditions

This warranty will apply only under all of the following conditions:

- The Item has been installed by a qualified tradesmen.
- The item has been installed for and subjected to domestic residential only.
- If failure is due to a fault in the manufacturing of the product.
- Proof of purchase ( Including the date of purchase) is provided.
- This warranty **does not include** faults caused by:
  - Unsuitable or improper use.
  - Incorrect installation not in accordance with the instructions provided.
  - Installation or part installation by the purchaser or any other person other than a qualified tradesman.
  - Normal wear and tear
  - Inadequate or complete lack of maintenance
  - Chemical, electrochemical or electrical influences.

This warranty does not cover products purchased as an ex-display without being fully checked and tested for sale by the manufacturer.

# HORIZONTAL SINGLE RAIL SIZING ROUND OR SQUARE

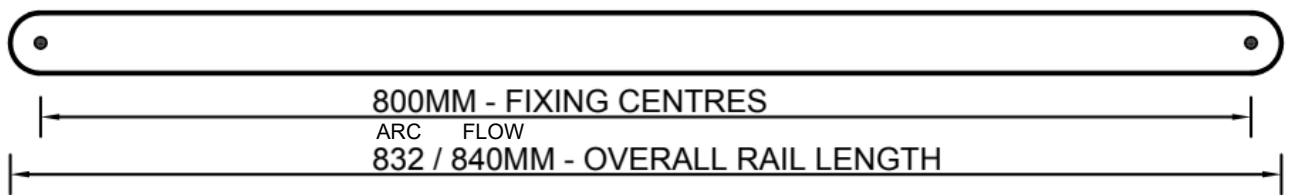
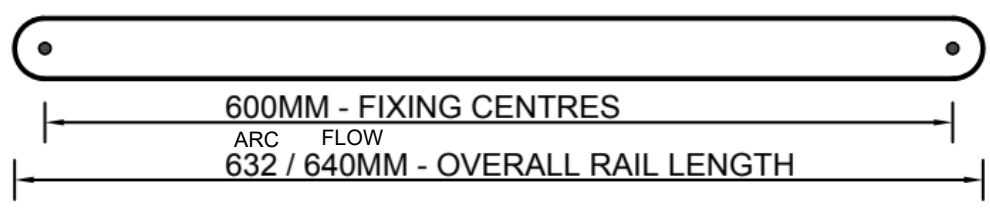
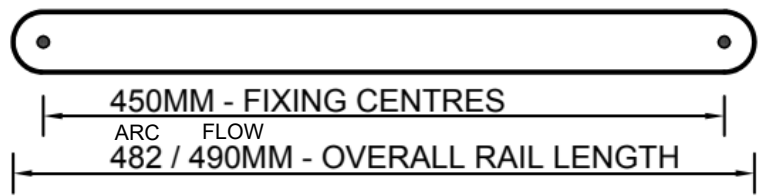

## SR-ARO

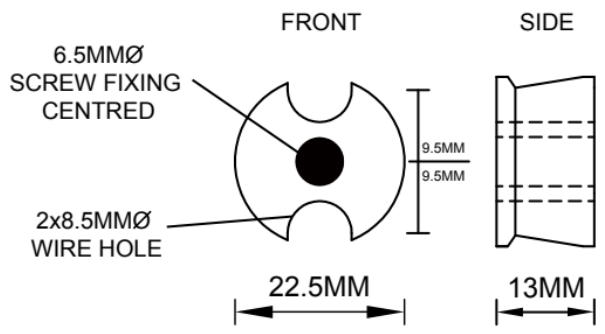

## SR-FLOW

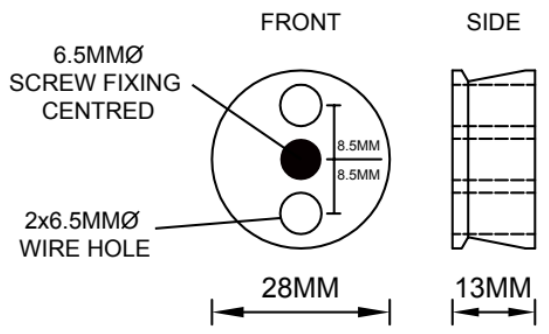

# Installation Guide

Thank you for choosing to install our quality Code Premium Heating product.

We have prepared these instructions to help you install the product both easily and successfully.

## Warning

- This Appliance **MUST** be installed by a **licensed** registered electrician.
- In order to avoid hazards for children, this appliance shall be installed so that the lowest rail is at least 600mm above the finished floor level.
- If the supply cord is damaged it must be replaced by the manufacturer prior to installing.
  - Code single heated rails power should be supplied by an approved transformer which provides 12 volts and sufficient output power to the specification of the product (see product rating label). Transformer must not be over loaded. We recommend our Code Transformer (Sold separately) which can range between 0–105W.

## TRANSFORMER SELECTION

- For 1 x Rail – Use 1 x (ET70) TRANSFORMER – 0W–70W This transformer is small enough to fit through and sit behind a standard switch plate.
- For 2 x Rails in one Location – Use 1 x (ET105) TRANSFORMER – 35W–105W This transformer is small enough to fit through and sit behind a standard switch plate.
- For 3 x Rails in one location – Use 1 x (ET105) TRANSFORMER – 35W–105W This transformer is small enough to fit through and sit behind a standard switch plate.
- For 4 x Rails in one location – Use 2 x (ET105) TRANSFORMER – 35W–105W (1 x per 2 rails) These transformers are small enough to fit through and sit behind a standard switch plate.
- For 4 x Rails in one Location – You can use 1 x (XLG–150–12–A) TRANSFORMER– CODE 12V – LARGE – SLVR This cannot fit behind a standard switch plate and must be accessible for future service – This large transformer can be located nearby inside a vanity, cupboard or in the ceiling cavity max distance of 3.5mtrs from the rails.

*Note for transformers ET70 and ET105 Max distance between Rails and transformer is 2.5mtrs (these transformers can fit behind a standard switch plate)*

*Note : For transformer XLG–150–12–A Max distance between Rails and transformer is 3.5mtrs (This transformer does not fit behind a standard switch plate – must be installed into a remote and accessible location)*

# PRE WIRE STAGE

## HORIZONTAL RAIL SETUP (LH OR RH WIRED)

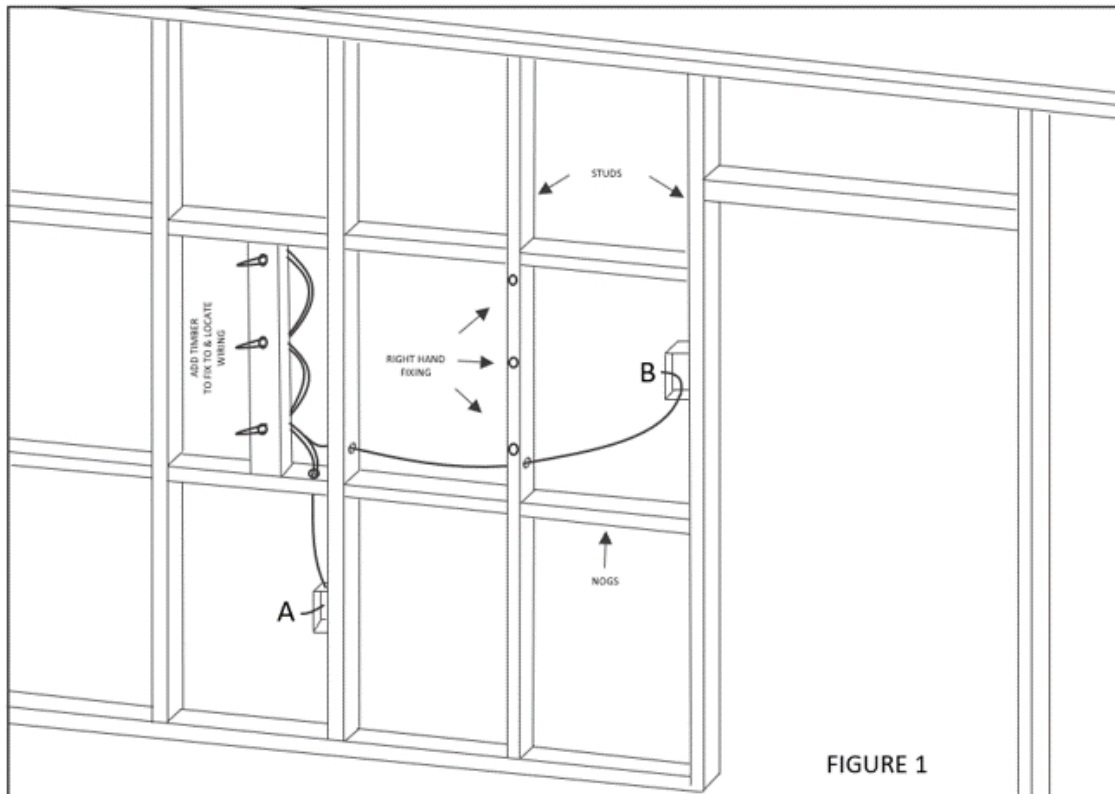

A – POWER SWITCH LOCATION NEAR RAILS (RECOMMENDED)

B – POWER SWITCH LOCATION NEAR DOOR

Prior to wall linings you need to prewire your towel rails – To do this you need to

1) Agree with the end user or designer on exact positioning considering other fixtures in the bathroom and heights for ease of use – take into account the actual length towels hanging on them to avoid fowling on anything, For example a vanity drawer or toilet roll holder. We typically recommend around 250mm between the bars.

2) Once the positioning/ layout has been confirmed, ensure there is a timber Nog fitted behind both feet of the heated rail. This timber will be used firstly to secure the pre wires in place for the duration of the painting and tiling stages. The timber will also be used to secure the wall fixing brackets after the painting or tiling. Simply fixing into Gibb with expanding wall plugs is not acceptable and may void warranty.

3) Once the wiring side is selected (**Note: Code Single rails are universal RH or LH wired.**) Mark the centre of the Rail foot and Drill holes to feed wire through. Use either the Code prewire Kit (SRTL PWKIT sold separately) or any suitable 12 volt wire. Drawer/ loop the wire though each hole and run back to the switch location where the transformer will be located later. Ensure you secure the wire on both sides of the fixing timber (you can use Glue/silicone or electrical tape) so it cannot slip back into the wall whilst other trades are performing their work. This is important, if the wire slips out of position the Gibb fixer or tiler will not know there is a wire to expose making it risky business later trying to relocate it.

After you have completed all the steps above – Congratulations your prewire is now complete

# Installation Guide

## FINAL FIT OFF

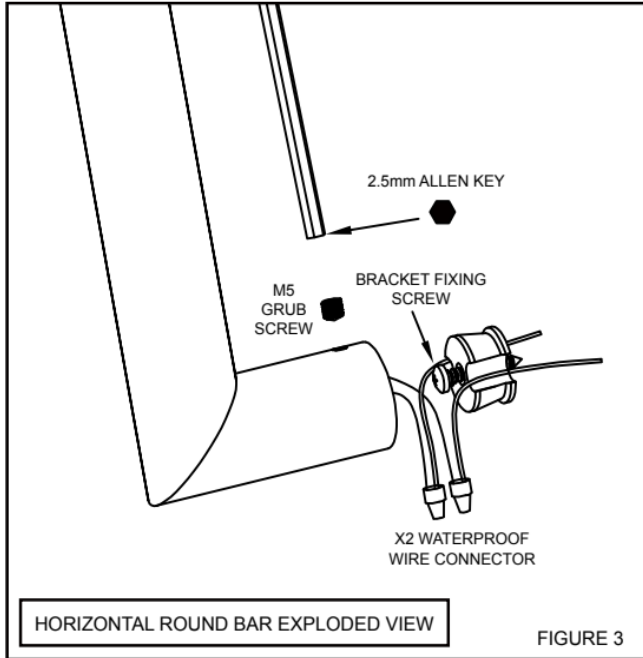

SR-ARO

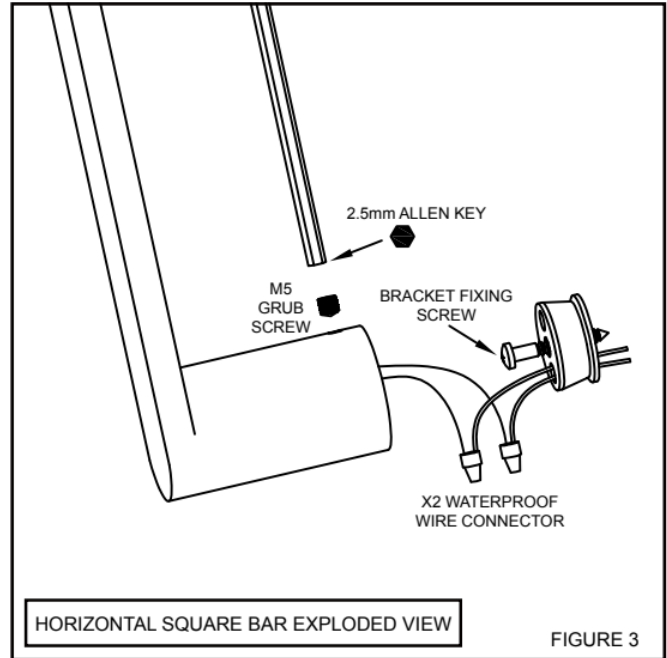

SR-FLOW

After the wall linings are complete your wires should still be exposed and be in the original position. These wires represent the centre of either your right or left foot of each rail.

*Note :* With our unique metal wall bracket system you have the option of bringing the wire or screw through either of the 3 holes provided (see diagram) giving you a final adjustment on the wall i.e. move them all up slightly or down or spread the area between the rails. This may also help you should a tile get chipped you can adjust feet to cover.

FIGURE 2

### CORRECT USE OF WATERPROOF WIRENUTS

- Strip wires 12.7mm (1/2").
- Align any frayed strands or conductors.
- Pre-twisting unnecessary. Place stripped wires together with ends of insulation even.
- Twist connector onto wires pushing firmly until hand tight (do not over torque).
- Wipe sealant in and around conductors and connector opening while tightening. DO NOT REUSE.

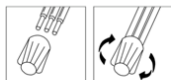

1) Mark out your rail feet Central locations (these can be above or below your wire position) and drill through wall linings until you hit the fixing timber.

2) Once the holes are drilled it is time to fit the mounting brackets to the wall – Feel free to use a small amount of silicone to prevent any chance of the fixings coming loose in years to come. To fit the wall fixings use the stainless square headed screws provided. Simply place rail fixing bracket against the wall and screw into the timber nog until securely fixed.

3) Repeat this again until all brackets are on wall. Once all the wall fixing brackets are fitted with the wires extending through it is time to fit the rail/s to the wall.

4) To fit the Rail/s to the wall, back off the fixing grub screws on both sides of the rail – dry fit the rail first to make sure feet are set right.

5) Once the rail fits correctly to the wall prepare both ends of the wires to be joined (rail side and wall side) Twist the wires together then thread into the provided water proof Drycon connectors – keep twisting in the same direction until you are happy the connection is good and there is no metal part of the wire outside the connector – It is normal to see some of the water proof grease squeeze out. **See figure 2**

6) Once you are happy with the connection push the wires and joiners up into the recess in the body of the rail, then present the rail to the wall brackets. Once the rail is hard against the wall it is time to tighten the fixing grub screws until the Rail is firmly mounted to the wall and does not wobble at all.

Repeat steps 4,5 and 6 until all rails are installed.

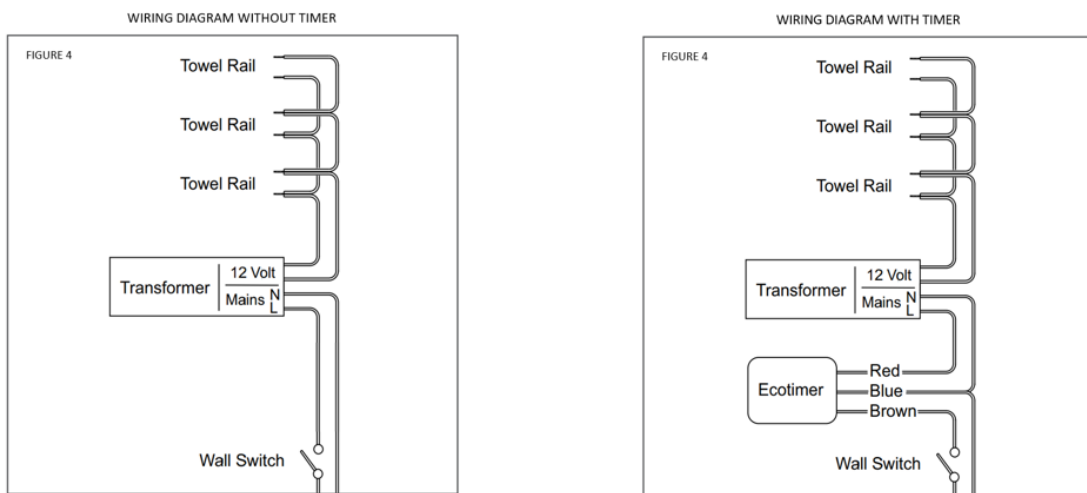

Once all the rails are installed, complete the wiring on the transformer and switch side

The Towel rail must have a switch in the bathroom that can be identified as the towel rail switch. This can be either located near the set of rails, or a separate mechanism on the light switch plate for the bathroom. e.g. 3 gang switch plate – lights – extractor – Towel rail.

Once wiring is complete turn on power and check all rails are heating – You will feel heat within just a few minutes.

Your installation is now complete .Please kindly leave the care and maintenance instructions with the owner.

Thank you for installing our Quality Code single rails we hope your client enjoys warm dry towels for many years to come.

Note: The installer and home owner have the option of fitting a timer (sold separately or as a part of the prewire Kit SRTL PWKIT) or without a timer. See figure 4 .For Prolonged element life and energy conservation we recommend that Code single bar rails should be connected to a timer set to 25% usage or less.